

4th International Conference
on
Global Efforts on Agriculture
Forestry, Environment and Food Security
 (Theme: Climate Change and Its Impact)
(GAFEF-2022)

**Souvenir Cum Abstracts/
 Proceedings Book**



EDITORS

- | | |
|---|--|
| <input type="checkbox"/> Dr. Wajid Hasan | <input type="checkbox"/> Dr. Santosh Marahatta |
| <input type="checkbox"/> Dr. Arjun Prasad Bastola | <input type="checkbox"/> Dr. Huma Naz |
| <input type="checkbox"/> Dr. C. P. Singh | <input type="checkbox"/> Dr. Md. Minnatullah |
| <input type="checkbox"/> Dr. Sanjay Swami | <input type="checkbox"/> Dr. Jit Narayan Sah |
| <input type="checkbox"/> Dr. Bhavna Verma | <input type="checkbox"/> Dr. Harikesh Singh |
| <input type="checkbox"/> Dr. R.K. Sohane | <input type="checkbox"/> Er. Jeetendra Kumar |
| <input type="checkbox"/> Mr. Kota Chakrapani | <input type="checkbox"/> Mr. Atul Kumar |
| <input type="checkbox"/> Ms. Neha Raina | <input type="checkbox"/> Dr. Mehjabeen |



Volume 1

September 17-19, 2022

Global Efforts on Agriculture, Forestry, Environment and Food Security (Climate Change and Its Impact)

Editors:

Dr. Wajid Hasan, Krishi Vigyan Kendra, Jahanabad, BAU, Sabour, Bihar, India
Dr. Santosh Marahatta, AFU, Rampur, Chitwan, Nepal
Dr. Arjun Prasad Bastola, Institute of Forestry, TU, Pokhara, Nepal
Dr. Huma Naz, MANFDC, India
Dr. C.P. Singh, Agricultural and Environmental Technology Development Society, U. S. Nagar, India
Dr. Md. Minnatullah, Sugarcane Research Institute, RPCAU, Pusa, Bihar, India
Dr. Sanjay Swami, School of NRM, CAU, Barapani, Meghalaya, India
Dr. Jit Narayan Sah, Institute of Forestry, TU, Pokhara, Nepal
Dr. Bhavna Verma, CIPM, Centre Indore, M.P., India
Dr. Harikesh Singh, Ganna Utpadhak, PG College, Baheri, UP, India
Dr. R.K. Sohane, Bihar Agricultural University, Sabour, India
Er. Jeetendra Kumar, Krishi Vigyan Kendra, Jahanabad, BAU, Sabour, Bihar, India
Mr. Kota Chakrapani, College of Agriculture, CAU, Imphal, Manipur, India
Mr. Atul Kumar, Bihar Agricultural University, Sabour, India
Ms. Neha Raina, Sharda University, Greater Noida, India
Dr. Mehjabeen, Hi-Limit Group, Ghana

First Edition 2022,

Copyright © Authors

All right reserved.

ISBN: 978-93-5659-453-1

No part of this book shall be reproduced or transmitted in any form or by any means, electronic or mechanical, including photocopying, or by any information storage and retrieval system without permission of the publisher.

DISCLAIMER

The authors are solely responsible for the contents of the papers compiled in this volume. The editors or publisher do not take any, responsibility for same in any manner. Errors, if any are purely unintentional and readers are requested to communicate such errors to the editors or publisher to avoid discrepancies in future.

Published by: Self Published

E-Publication

Website: www.agetds.com, e-mail: entowajid@gmail.com



Tribhuvan University
OFFICE OF THE VICE CHANCELLOR

Kirtipur, Kathmandu, Nepal



Ref. No.:



Message

With immense pleasure and pride, I heartily congratulate the Institute of Forestry, Tribhuvan University for organizing the 4th **International Conference on “Global Efforts on Agriculture, Forestry, Environment and Food Security (GAFFEF-2022)”** with the *premise of Climate Change and Its Impact*, in collaboration with Agricultural & Environmental Technology Development Society (AETDS), U.S. Nagar, India; Faculty of Agriculture, Agriculture and Forestry University, Rampur, Chitwan, Nepal; Forest Research Centre for Eco-rehabilitation, Prayagraj (U.P.), India; Gandaki University, Kaski, Pokhara, Nepal & in association with Institute of Root Biology, Yangtze University, China and Soil, Water & Environment Research Institute, Giza, Egypt at Institute of Forestry, Tribhuvan University, Pokhara Campus Pokhara, Nepal on September 17-19, 2022.

In view of the focus of changing Global climate and world economy on agriculture, the organizers have very rightly selected the most relevant topic and is need of the hour and highly appreciable.

Agriculture and Forest are both important components of rural livelihoods. Scientist of both sciences are playing pivotal role for developing novel tools and technologies in the field. Combating climate change and ensuring food security are both extremely important. While protecting and restoring forests is critical for stopping climate change, but the big gains in improving food security will happen elsewhere. The 20-30 agenda for sustainable development, as well as the Paris agreement on climate change recognizes that we can no longer look at food security and the management of natural resources separately. There are clear linkages and synergies between agricultural production and sustainable forest management. If the sustainability of the agriculture and forests can be assured, food security, environmental safety and sustainable development would go in long-term perpetuity.

Participants from several organization of national and international repute around the world meet here to share their research findings. I am confident that the conference will provide an excellent opportunity for active interaction with Academicians, Eminent International Professors, Prominent Agriculturalists, Food Security Experts, Environmentalists and Authorities working in various fields of Life Sciences to discuss various issues related to Agriculture, Forestry, Environment and Allied Sciences. Moreover, deliberations and sharing of the core ideas, experiences, creative imaginations, innovations of different expertise under different sub-themes in the conference will be a milestone for the solutions of ongoing challenging issues of climate change and food security of the world. Indeed, I believe that, such kind of scholarly gatherings could play a vital role in making the world a better place and also make ready to tackle any difficult situations in the near future.



Tribhuvan University
OFFICE OF THE VICE CHANCELLOR

Kirtipur, Kathmandu, Nepal



Ref. No.:

I would like to appreciate the organizing institutes of this conference and congratulate Dr. Arjun Prasad Bastola, Associate professor, IOF/TU and Conference Director **GAFEF-2022**, Dr. Wajid Hasan, Secretary and Prof. C.P. Singh President AETDS, Society, U.S. Nagar, India for taking initiation and leadership.

I am confident that the participants will take the fullest advantages of this international conference and will enjoy the excellent weather of Pokhara.

Finally, I wish a grand success of the Conference for an eminent accomplishment in achieving its goal.

Prof. Dr. Dharma Kanta Baskota
Vice Chancellor



Dr.T.JANAKIRAM, ARS

Ph.D.(IARI), FISOH, FISVS, FHSI & FISHRD

Vice-Chancellor

In India, the horticulture industry provides roughly 33% of the Gross Value Addition and generates over 320 million tonnes of goods (GDA). Along with assuring the nation's food security, it also diversifies farming operations, creates alternative rural job options, and boosts farmers' income. Presently 320.48 million tonnes of horticultural products are produced in India, surpassing the production of food grains. The creative and cutting-edge methods used in horticulture have proved the profitable farming without causing much disturbance to the Natural Resources, Environment.

The production of horticultural crops grew by 38% in India during 2004–2005 and 2019–20. A balanced diet and a healthy lifestyle are enhanced by the wide variety of fruits and vegetables that are produced via horticulture. These foods are a valuable source of nutrients. Thus, as people's concerns about their health and wellbeing grow, so does the demand for these items. The demand for flowers for gifts and decorating has also expanded as a result of rising wealth and contemporary lifestyles.

In Andhra Pradesh, horticulture crops are grown on a total of 17.95 lakh hectares, producing 314.78 lakh MTs. Horticulture had 10.17% growth over the prior year and contributed Rs. 49,189 crore to Andhra Pradesh's GVA in 2020–21. In order to improve price realisation, the government of Andhra Pradesh has identified the horticulture industry as one of the growth engines, with a focus on increasing the production, productivity, and quality of different horticultural crops along with the development of value chains and marketing links.

Horticultural Crops address the climate resilience and quite suitable for off season / year round cultivation. Availability of quality planting material, Invasion of new insect pests and diseases, Post-harvest losses, lack of skilled personnel & mechanization, introduction of new crops & varieties by farmers themselves and climate change are some of the challenges in horticultural crops. In this direction, innovative extension strategies and programs to be organized for awareness, importance, production and productivity, sustainable way.

:2:

The horticulture sector as a diversified function of the agriculture sector has become a promising source of income opportunities. It contributes towards a steady growth for the sector as well as for the economy. A conscious effort is required to implement certain initiatives that would lead to the future growth and development of the horticulture sector. Adoption of package of practices, Integrated crop management including pest and disease control, organic cultivation of vegetables,.

I congratulate the organisers for selecting the appropriate themes during the 4th International Conference on "Global Efforts on Agriculture, Forestry, Environment and Food Security (GAFEF-2022)" and the three days deliberations during the international conference would bring new approaches, methodologies and policies for improvement of farm production and productivity in ecofriendly manner.

(T.JANAKIRAM)





कृषि तथा वन विज्ञान विश्वविद्यालय उपकुलपतिको कार्यालय

Agriculture and Forestry University
Office of the Vice Chancellor
Rampur, Chitwan, Nepal



MESSAGE

This is my honor and privilege to deliver this message on behalf of Agriculture and Forestry University for this important event of the International Conference on “Global Efforts on Agriculture, Forestry, Environment and Food Security (Theme: Climate Change and Its Impact) (GAFEF-2022) to be held during 17th - 19th September 2022. With most appreciation I am thankful to all organizers, namely, Agricultural & Environmental Technology Development Society (AETDS), U.S. Nagar, Uttarakhand, India; Institute of Forestry, Tribhuvan University, Pokhara Campus, Pokhara, Nepal; Faculty of Agriculture, Agriculture and Forestry University, Rampur, Chitwan, Nepal; Forest Research Centre for Eco-rehabilitation, Prayagraj (U.P.), India; Gandaki University, Pokhara, Nepal; and in association with Institute of Root Biology, Yangtze University, China and Soil, Water & Environment Research Institute, Giza, Egypt at Institute of Forestry, Tribhuvan University, Pokhara Campus Pokhara, Nepal.

The main challenge faced by the world community today is the global warming and associated climate change effects. The most damaging impacts of climate change for all south Asian countries are mostly related to water resources and agriculture. The agricultural sector is the major source of employment for all south Asian countries and we have to carefully plan as well act for the climate resilient agriculture. Loss of both agricultural land and production will adversely affect the livelihoods of agricultural communities.

The Earth, the one and only liveable habitat for humans, other animals, and plants, facing problems due to climate change effects and global pandemic COVID-19. In this respect, our responsibility is to develop coping strategies on mitigation and adaptation. Limited agricultural resources and continuous population increase in the south Asian countries ultimately lead to an ecological imbalance thus aggravating the food security issues in coming decades. In addition, under the present pandemic-led circumstance under changing climatic conditions, farmers and their farming have become more challenging and vulnerable to ensure food and nutritional security. Thus, there is a great need for institutional efforts and people’s participation to address issues related to food security, ecological safety, sustainable development, and conservation of natural resources. The linkages between science and society is essential. I am sure during the three days deliberations scientists from south Asia will be able to come up with solid recommendations and frame future strategies to improve agricultural productivity and sustainability in Asia. I wish the grand success of this conference.

Prof. Punya Prasad Regmi, Ph.D.
Vice Chancellor

UNIVERSITY OF AGRICULTURAL SCIENCES, RAICHUR

Lingasgur Road, Raichur - 584 104, Karnataka, India



Dr. K.N. KATTIMANI

M.Sc.(Agri.), Ph.D. FCHAI

Vice-Chancellor



MESSAGE

I am very happy to learn that **Agricultural & Environmental Technology Development Society, Uttarakhand, Institute of Forestry, Tribhuvan University, Pokhara, Nepal, Agriculture and Forestry University, Nepal, Forest Research Centre for Eco-rehabilitation, U.P., Gandaki University, Nepal in association with The Institute of Root Biology, Yangtze University, China, Soil, Water & Environment Research Institute, Giza, Egypt organized 4th International Conference on “Global Agriculture, Forestry, Environment and Food Security (GAFEF-2022)” commencing from September 17-19, 2022 with the theme of “Climate Change and It’s Impact”.**

Indian agriculture is experiencing a difficult situation because of high input costs compared to the farm output and over exploitation of natural resources like soil and water. During the last two decades, farmers' livelihood have depended precariously on a changing environment that they are unable to fully comprehend since they lack access to modern farming tools and methods.

Climate change poses a big challenge to all the diversions, including agriculture, forestry, and ecosystems, which in turn may lead to a threat to the food security of the country. To increase the profitability of cropping systems, forestry enrichment, farm mechanization, and balancing ecosystems need to be integrated. I am confident that deliberations made during the 4th International Conference will result in a concrete road map that will help us surmount a formidable road block and attain a major national objective of doubling farmers' income while restoring the ecosystem.

On this occasion of the 4th International Conference on "Global Agriculture, Forestry, Environment and Food Security (GAFEF-2022)," I extend my greetings to the faculty of different organizations and with a grand success by offering many more invaluable services to the farming community and the nation.

[**K.N. Kattimani**]

Vice-Chancellor



गण्डकी विश्वविद्यालय

गण्डकी प्रदेश, नेपाल

Gandaki University

Kaski, Nepal

प स-०७७/०७

August 29, 2022

MESSAGE

I am pleased to know that 4th International Conference on 'Global Agriculture, Forestry, Environment and Food Security (GAFF-2022)' is going to be held at the one of the world's touristic and beautiful city of Pokhara, Nepal in September 2022.

Organizing scientific events-conference, workshop, scientific meetings and similar activities always supports scientific communities to move forward in the direction of research, innovation and serving to the humankind in the short as well as long run. I am sure, this international scientific event will have tremendous importance to the all sectors of people-locally, regionally as well as globally.

One of the important parts of scientific event is producing conference souvenir book. Under this context, I am much delighted to know the publication of Abstract cum Souvenir Book (Conference Proceeding) of the 4th International Conference on the theme stated above that all the participants will be much benefitted with this collection. In this sense, hard work of organizing committee, workshop secretary and all other concerned stakeholders has been truly reflected in this Proceeding, and I would like to congratulate all team members for this achievement.

I wish all the best and for a grand success of the conference.

Prof. Naba Raj Devkota, PhD

Vice-Chancellor, Gandaki University, Gandaki Province, Nepal

Email: vc@gandakiuniversity.edu.np/ nabadevkota.gandaki@gmail.com

Mobile: [+977-9851194684](tel:+977-9851194684)



भाकृअनुप - कृषि प्रौद्योगिकी अनुप्रयोग अनुसंधान संस्थान, जोन-IV
गर्भूचक, जगदेवपथ, पटना -800014 (बिहार)

ICAR-Agricultural Technology Application Research Institute, Zone-IV
(Indian Council of Agricultural Research, Ministry of Agriculture and Farmers Welfare)
Garbhuchak, Jagdeopath, Patna- 800014, (Bihar)



MESSAGE

It gives me immense pleasure to know that the 4th International Conference on “Global Efforts on Agriculture, Forestry, Environment and Food Security (Theme: Climate Change and Its Impact) (GAFEF-2022)” being jointly organized by Agricultural & Environmental Technology Development Society (AETDS), U.S. Nagar, Uttarakhand, India, Institute of Forestry, Tribhuvan University, Pokhara Campus Pokhara, Nepal at Institute of Forestry, Tribhuvan University, Pokhara Campus Pokhara, Nepal on September 17-19, 2022, along with other reputed organizations around the world. The theme for this year conference “Climate Change and Its Impact” is of global priority today.

There is a great need for institutional efforts and peoples’ participation to address issues related to food security, environmental safety, sustainable development and preserving natural resources in general. To do so, the linkages between agricultural and applied sciences are essential. Collective efforts should be made by relevant institutions through ensuring participations of people from all walks. I am sure that this International Conference will focus on the various scientific tracks covering major areas of research on agriculture, biological and applied sciences and would become a platform for bringing together administrators, business bodies, policy makers and the members of global scientific community including scientists, researchers and distinguished professors to find out the key problems, challenges and pragmatic solutions which will help in in-depth understanding of the global food security and environmental safety issues in a long-lasting way.

There is a need to reach out further and communicate globally to increase multi-sectoral policy prioritization, interdisciplinary engagement, and public–private investment on the emerging issues. I do believe that the outcomes of this International Conference will help policy makers to formulate plans and take immediate actions appropriate for ensuring food and nutrition security and agricultural sustainability in the deprived regions of the world. I would like to appreciate the organizing institutes of this conference and thank the people whose dedicated efforts and creative plans will make the conference successful.

Finally, I wish a grand success of 4th International Conference on “Global Efforts on Agriculture, Forestry, Environment and Food Security (Theme: Climate Change and Its Impact) (GAFEF-2022)”.

Dr. Anjani Kumar



Ref: AETDS/SO/408

Date: 01.09.2022



From the Desk of the President AETDS, India

On behalf of the Organizing Committee, I welcome all members to the 4th International Conference on “Global Efforts on Agriculture, Forestry, Environment and Food Security (GAFEF-2022)”.

I am pleased to send greetings as President of AETDS and Chairperson of the International Conference which is going to be organized jointly by Agricultural & Environmental Technology Development Society (AETDS), U.S. Nagar, Uttarakhand, India; Institute of Forestry, Tribhuvan University, Pokhara Campus Pokhara, Nepal; Faculty of Agriculture, Agriculture and Forestry University, Rampur, Chitwan, Nepal; Forest Research Centre for Eco-rehabilitation, Prayagraj (U.P.), India; Gandaki University, Kaski, Pokhara, Nepal and in association with Institute of Root Biology, Yangtze University, China and Soil, Water and Environment Research Institute, Giza, Egypt at Institute of Forestry, Tribhuvan University, Pokhara Campus Pokhara, Nepal from September 17th-19th, 2022.

As the ecological relationship between environment, land, food, forestry and agriculture are highly diversified and complex, the interactive discussions by the international scientific community on the issues such as food security, environmental safety, conservation of natural resources and forestry are the need of the day for the sustainable global growth as well as solution for global warming due to climatic change. Thus, the interactive sessions among the global scientists would definitely come to the conclusion to formulate some useful recommendations for the upliftment and growth of end users worldwide.

We’re looking forward to an excellent meeting with renowned scientists, academicians, research scholars and youth from different countries around the world and sharing new and exciting results during the conference.

(Prof. C. P. Singh)

Conference Chairperson

President, AETDS, Society, U.S. Nagar, Uttarakhand, India

Former Prof. GBPUAT, Pantnagar, India



TRIBHUVAN UNIVERSITY
INSTITUTE OF FORESTRY
Office of the Dean

Kirtipur
Kathmandu, Nepal

Ref.No:

30 August 2022

Institute of Forestry is happy to be a part of an initiative in organizing 4th International Conference on “Global Agriculture, Forestry, Environment and Food Security (GAFEF-2022)” together with Agricultural & Environmental Technology Development Society, Uttarakhand, India and other esteemed Universities and partners to deliberate recent advances made by the researchers and in shedding light on the future research needs in the thematic areas of **Climate Change and Its Impact**. As we know that in recent decades’ global community particularly people residing in South Asia Regions are facing enormous problems caused due to over consumptions of the resources, population pressure, climate change, environmental degradation, and other social, political & economic inequalities. Among others, climate change has become the most profound threat to the security and well-being of human life and property. The shortage of food, fuel and the increasingly intense and more frequent occurrences of droughts, floods, earthquakes and hurricanes provide a grim picture of the impact of climate change. The common agenda for us now is to limit the impact of climate change and to cope effectively to its resultant impacts. Every country needs to be aware of the devastating impact of climate change and should be prepared to manage the situation in a systematic manner. I believe that the conference participants will bring forth innovative ideas to enlighten us and our collaborative efforts will help not only to generate the evidence based scientific knowledge but also contribute in finding solutions of the major problems caused due to climate change in the region.

Finally, I would like to wish a grand success of the three days’ international conference. I also would like to thank the distinguished guests and participants for sparing their valuable time for this conference and wish all your pleasant and fruitful stay at Pokhara.

Thank you !

.....
Prof. Bir Bahadur Khanal Chhetri, PhD
Dean



भा.कृ.अनु.प.- राष्ट्रीय अनार अनुसंधान केन्द्र, सोलापुर
ICAR - National Research Centre on Pomegranate
(ISO 9001:2015 Certified Institute)



डॉ.राजीव मराठे, निदेशक
Dr. Rajiv Marathe, Director



MESSAGE

I am glad to know that the Agricultural and Environmental Technology Development Society and Institute of Forestry, Tribhuvan University, Pokhara, Nepal, is organizing a 4th International Conference on “**Global Efforts on Agriculture, Forestry, Environment and Food Security (GAFEF-2022) from September 17-19, 2022.**”

Our planet is blessed with abundant natural resources, however, the growing population and unabated and careless misuse of these resources is posing a serious threat to their sustainability. It is high time for us to take necessary measures for the preservation and protection of these natural resources which otherwise may risk the existence of our future generations.

This event provides a common platform and witnesses with the participation of scientists working in different fields of Agriculture, Forestry, Environment, and Food Security. I strongly believe that the conference will result in concrete output in support of its topics. The conference will also provide a platform for brighter minds to get together and ponder on many global issues and suggest innovative actions to meet the challenges.

It is indeed a laudable endeavor on the part of AETDS, to organize the conference on such a large scale and provide a gathering of more than 1000 participants all around the globe.

I hope all the participants will enjoy this academic fest.

I wish the conference a grand success.

(R. A. Marathe)

कृषि तथा वन विज्ञान विश्वविद्यालय
कृषि संकाय
डीनको कार्यालय
रामपुर, चितवन, नेपाल



Agriculture and Forestry University
Faculty of Agriculture
Office of the Dean
Rampur, Chitwan, Nepal

प.सं./Ref. No.

च.नं.

मिति/Date:

MESSAGE

I am pleased to know that the Agricultural & Environmental Technology Development Society (AETDS), U.S Nagar, Uttarakhand, India, Institute of Forestry, Trichuvan University, Pokhara Campus Pokhara, Nepal, Faculty of Agriculture, Agriculture and Forestry University, Rampur, Chitwan, Nepal, Forest Research Centre for Eco-rehabilitation, Prayagraj (U.P.), India, Gandaki University, kaski, Pokhara, Nepal in association with Institute of Root Biology, Yangtze University, China and Soil, water & Environment Research institute, Giza, Egypt at Institute of Forestry, Tribhuvan University, Pokhara Campus Pokhara, Nepal is going to organize the 4th International Conference on "global Efforts on Agriculture, Forestry, Environment and Food Security (Theme: Climate Change and Its impact) (GAFEF-2022) Duting 17th-19th September 2022 to mark the occasion Published.

The Earth, the only liveable havitat for living creatures has been fecing tremendous environmental pressures in recent years. The scarce agricultural resources and continuous population increase in developing countries created an environmental inbalance and hence aggravating the food security. In addition under the present Covid-19 pandemic circumstance farming practice has become more challenging and vulnerable to ensure food and nutirional secutiry. Thus, there is a great need for institutional efforts and people's participation to address issues related to food security, encironmental safety, sustainable development, and preserving natural resources by strengthening linkages between agriculture and applied sciences. I am confident that during the three days deliverations, the scientists from south Asia will be able to come out with valid recommendations and future strategies to improve productivity, and sustainable utilization as well as expansion of crops and livestock in the context of global warming and changing climate. I wish grand sucess of the conference and

Prof. Jay Prakash Dutta
Dean
Faculty of Agriculture
Agriculture and Forestry University



पारि-पुनर्स्थापन वन अनुसंधान केन्द्र प्रयागराज
FOREST RESEARCH CENTRE FOR ECO-REHABILITATION PRAYAGRAJ
(भारतीय वानिकी अनुसंधान एवं शिक्षा परिषद)
(वन, पर्यावरण एवं जलवायु परिवर्तन मंत्रालय, भारत सरकार की एक स्वायत्त निकाय)
(A Centre of Indian Council of Forestry Research & Education, Dehradun,
an autonomous body of MoEF & CC, Govt of India)



No/ पत्रांक: .IV./27/2021./FRCE/R/Vol.2/ 401

Date/दिनांक: .05/09/2022

MESSAGE

Issues pertaining to Agriculture, forestry and environment, having direct impact on food security, are entwined in a complex manner that they are difficult to be viewed and understood in isolation. As per estimates food production will have to be increased by 60 % by 2050 to satisfy the growing demand driven by a projected 9.7 billion population. Well managed and diverse forests and incorporation of trees in agricultural systems also provides benefits in food security. However, climate change threatens this crusade against hunger and malnutrition cutting crop yields, especially in the world's most food-insecure regions. Both agriculture and forestry will be affected by climate change. Reforestation and reductions of deforestation have been recognized as efficient and effective alternatives to mitigate climate change.



Globally, biodiversity for food and agriculture is in decline posing a serious threat to global food security, making agriculture less resilient to climate change, pests and diseases. Farmers' varieties and landraces are disappearing at an unprecedented speed resulting in increasingly homogenous global diets. Out of the 6,000 different plant species used as food, only nine contribute 66% of total crop production. There is therefore an urgent need to improve our knowledge on ecosystems for food and agriculture, and in particular, to study the role of associated biodiversity. This will help us to better understand, conserve and manage the diversity that underpins our food systems.

In addition to these challenges faced by agriculture; the direct impacts of unsound and invading agricultural practices on land cover and ecosystems, and on global and regional cycles of carbon, nutrients and water must also be accounted and addressed. At the global level, agriculture contributes to climate change through emission of greenhouse gases and reduction of carbon storage in vegetation and soil while at local level it reduces biodiversity and affects natural habitats through land conversion, eutrophication, pesticide inputs, irrigation and drainage.

I am happy that 4th International Conference on "Global Agriculture, Forestry, Environment and Food Security (GAFEF-2022) is being jointly organized by Agricultural & Environmental Technology Development Society (AETDS), U.S. Nagar, Uttarakhand, India, Institute of Forestry, Tribhuvan University, Pokhara, Nepal, Faculty of Agriculture, Agriculture and Forestry University, Rampur, Chitwan, Nepal, and Gandaki University, Kaski, Pokhara, Nepal

Hopefully the deliberations in this three days conference will results into better understanding for prudent management of global production systems and environment for ensured food security.

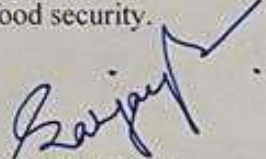
Dr. Sanjay Singh
Scientist G & Head



TRIBHUVAN UNIVERSITY
INSTITUTE OF FORESTRY
POKHARA CAMPUS
POKHARA, NEPAL

Ref No.:



Message

With great immense, I am pleased and honored to extend to you a warm invitation to attend 4th International Conference on “**Global Efforts on Agriculture, Forestry, Environment and Food Security (GAFF-2022)**” to be held on 17-19 September 2022 at Tribhuvan University, Institute of Forestry, Pokhara Campus, Pokhara, Nepal.

I am sure that this conference will provide a forum to national and international researchers, academicians, students, and development workers to interact and involve in research and innovation to widen the horizons of their knowledge and work experience in the field of Agriculture, Forestry, Environment and Food Security with focus on climate change and its impacts.

I hope the conference will strive to offer plenty of networking opportunities, providing you with the opportunity to meet and interact with the leading scientists and researchers, friends and colleagues. I also expect you to take a little extra time to enjoy the spectacular and unique beauty of spectacular Pokhara city.

I sincerely appreciate the humble and joint efforts of the organizing partners in providing a platform for students, academicians, researchers and development workers to share their ideas and research outcome through the forum of this conference. I give my best wishes to all delegates and organizing committee to make this event a grand success.

Prof. Binod Prasad Heyojoo
Campus Chief



Arjun Prasad Bastola, PhD
Associate Professor
Tribhuvan University, Institute of Forestry
Pokhara Campus Pokhara - 33700, Nepal
Conference Director (GAFEF-2022)
Email: arjun.bastola@pc.tu.edu.np, Cell: +977 9845025781



Message from Conference Director

It gives me immense pleasure to be Conference Director and welcome you to the fourth International Conference “Global Efforts on Agriculture Forestry, Environment and Food Security (GAFEF; 2022)” from 17th to 19th September; 2022 at the Institute of Forestry Tribhuvan University, Pokhara Campus, Pokhara, Nepal. The event is jointly organised by Agricultural & Environmental Technology Development Society (AETDS) US Nagar, Uttarakhand, India; Institute of Forestry, Tribhuvan University, Nepal; Faculty of Agriculture (FOA), Agriculture and Forestry University, Chitwan, Nepal; Forest Research Centre of Eco-rehabilitation, Payagraj, Uttar Pradesh, India; Gandaki University (GU), Pokhara, Nepal; in association with, Institute of Root Biology, Yangtze University, China; Soil, Water and Environmental Research Institute (SWERI), Agriculture Research Center (ARC), Giza, Egypt.

The COVID-19 pandemic is still on-going. During the last couple of years, the world has experienced and realized how whimsical the nature could be at times and how badly the consequences could affect the entire mankind for food, treatment and shelters. As we know this world is still the one and only liveable habitat for human, other animals and plants which is facing tremendous environmental pressures in recent years due to regular advent of natural disasters. Limited agricultural resources and continuous population increase in developing countries ultimately leading to an environmental imbalance thus aggravating the food security issues in coming decades. In addition, under the present pandemic circumstance, farmers and their farming have become more challenging and vulnerable to ensure food and nutritional security. However, to comply with the SDGs’2030 we need to nurture our environmental resources in a sustainable way giving emphasis on sourcing renewable energies.

As a Director of the Organizing Committee, I am grateful to the researchers and academicians of national and international level and others who have offered their collaboration by submitting constructive papers and abstracts for this conference. Finally, I wish the conference an eminent accomplishment in achieving its goal towards food security, environmental safety and sustainable development thus enlightening global innovative in agricultural, forestry and applied sciences.

Dr. Arjun Prasad Bastola
Conference Director
Institute of Forestry
TU, Pokhara, Nepal



**Dr. Sanjay-Swami, Professor (SSAC)
& Organizing Convener: GAFEF-2022**
School of Natural Resource Management,
College of Post Graduate Studies in
Agricultural Sciences (CPGS-AS)
(Central Agricultural University)
Umiam-793 103 Meghalaya, India
E-Mail: sanjayswamionline@gmail.com
Cell: + 91-9419157291



MESSAGE

It is indeed a matter of great pride for me in organizing the 4th International Conference “*Global Efforts on Agriculture, Forestry, Environment and Food Security*” (GAFEF-2022) organized by the Agricultural & Environmental Technology Development Society (AETDS), U.S. Nagar, UK, India in association with many other reputed organizations at Institute of Forestry, Tribhuvan University, Pokhara Campus, Pokhara, Nepal from 17th to 19th September 2022 to address the global issues of climate change and its impacts.

As you are aware, climate change has already caused significant impacts on agriculture, natural resources, food security and human health throughout the world. With nearly 690 million people facing hunger, agri-food systems emitting one third of global anthropogenic GHG emissions and a growing public demand for climate action, it is pressing to achieve food security while adapting to - and mitigating - climate change.

The studies on climate change impacts and adaptation strategies are increasingly becoming major areas of scientific concern and the results of the published research on climate change reveal a regional specificity that is difficult to be extrapolated on a global scale to predict the response of climate change across ecosystems. The challenges and problems are complex, trans-boundary and difficult to be resolved by a single country, a single discipline, or single institution. There is a need to reach out further and communicate globally to increase multi-sectoral policy prioritization, interdisciplinary engagement, and public-private investment on the emerging issues.

I am confident that this International Conference will provide a right platform to the learned researchers from various backgrounds to deliberate on the risks associated with climate change, and will come-up with some concrete recommendations to face the challenges ahead.

I wish the International Conference a grand success.

Dated: 17-09-2022

(Sanjay Swami)



MESSAGE

It gives me great pleasure to congratulate it on the convening of the 4th International Conference on “Global Efforts on Agriculture, Forestry, Environment and Food Security (GAFEF-2022) organized by Agricultural and Environmental Technology Development Society and Institute of Forestry, Tribhuvan University, Pokhara, Nepal, on September 17-19, 2022.

As we all know, agriculture, forestry, environment and food are important resources for the survival of life on Earth, including human beings. Excessive exploitation and utilization, without attention to safety and sustainable development, will lead to the deterioration of the global climate, the destruction of the human living environment, and irreversible damage to various ecosystems. This will threaten our resources for the survival of future generations.

The upcoming convening of GAFEF-2022 provides a platform for scholars to communicate with each other, so that relevant opinions can be fully expressed in the conference. The results of such a meeting will also provide a lot of reference for relevant governments to make policy.

I believe this meeting will be held in two organizing committees (Agricultural and Environmental Technology Development Society and Institute of Forestry, Tribhuvan University), which arranged and organized the successful convening of the conference.

I also congratulate the conference on achieving its intended purpose and great success.





Agricultural & Environmental Technology Development Society (Regd.) AETDS, U.S. Nagar, UK, India

(Registration No. UK06708052019001367, Under the Registration Act No. 21, 1860)

www.agetds.com, Email: humanazscientist@gmail.com Mob: +91 95576 97271



Ref: AETDS/SO/410

Date: 01.09.2022



Message from Managing Chairman's Desk

The members of the organizing committee and I are very proud to present the 4th International Conference on “Global Efforts on Agriculture, Forestry, Environment and Food Security (GAFEF-2022)”, welcoming all participants to Pokhara, Nepal from 17th to 19th of September 2022.

It gives me immense pleasure to welcome you all as a Managing Chairman of the International Conference that is being jointly organized by Agricultural & Environmental Technology Development Society (AETDS), U.S. Nagar, Uttarakhand, India, Institute of Forestry, Tribhuvan University, Pokhara Campus Pokhara, Nepal, Faculty of Agriculture, Agriculture and Forestry University, Rampur, Chitwan, Nepal, Forest Research Centre for Eco-rehabilitation, Prayagraj (U.P.), India, Gandaki University, Kaski, Pokhara, Nepal & in association with Institute of Root Biology, Yangtze University, China and Soil, Water & Environment Research Institute. Giza, Egypt at Institute of Forestry, Tribhuvan University, Pokhara Campus Pokhara, Nepal. The conference aimed at expanding the program by including all aspects related to protected agriculture, forest, food, and greenhouse farming developing and integrating components for production and protection as a multidisciplinary approach for essential sustainable management. The various subthemes of the conference will offer many opportunities to delegate to learn new things and apply the same in their respective workplace. It will also be a platform to strengthen the friendship and collaboration among scientists, academia, and institutes. The diversity of specializations and related themes will enable us to achieve our targeted mandate and vision. Authors and attendees, from different continents including unique Key Note speakers, will show us their recent developments in varied fields in the world of agriculture, environment and food. The hard work and dedication of all the members of the organizing, scientific, technical, and financial committees during the preparation for this conference is highly appreciated. Without them, the event would not have been possible.

My personal respect goes out to all of you.
I look forward to welcoming all of you at GAFEF-2022.

(Dr. Huma Naz)

Managing Chairman (AETDS)



Er. Jeetendra Kumar,
Organizing Co-Convener: GAFEF-2022
Krishi Vigyan Kendra, Jehanabad
(Bihar Agricultural University, Sabour)
Bihar-804432, India
E-Mail: jeetkjeet2004@gmail.com
Cell: + 91-9472362336



MESSAGE

It is matter of immense pleasure in organizing the 4th International Conference on “*Global Efforts on Agriculture, Forestry, Environment and Food Security*” (GAFEF-2022) organized by Agricultural & Environmental Technology Development Society (AETDS), U.S. Nagar, UK, India in association with many national and international organizations of repute at Institute of Forestry, Tribhuvan University, Pokhara Campus, Pokhara, Nepal from 17th to 19th September 2022 to address the global issues of climate change and its impacts.

Climate change refers to long-term change in temperatures and other weather parameters that may be natural or human made. It affects quantity as well as frequency of rainfall and also causes heat/cold wave that directly affects agricultural production. As climate change has great impacts on farming as well as natural resources, it affects food security and human health. Major population of not only Asian continent but the whole world is facing tragedy of global warming. GHG emissions and other concerns of climate change impacts have to be minimizing though development and implementation of suitable agricultural interventions to achieve food security.

Adaptation to climate change requires both short and long term strategies. In short term, one must use the experience and knowledge base to design and implement crop contingency plans according to changing weather conditions whereas in long term, strategic research are required to be developed and implemented for drought/flood situations. Heat tolerant crop varieties, livestock breeds as well as technologies for natural resources conservation are also need to be focused to sustain heat stress. Land and water management practices contribute to both adaptation and mitigation. Recourse management based strategies may include soil and water conservation, efficient use of irrigation water, use of renewable energy in farm operations and agro forestry system for carbon sequestration. Risk management through weather insurance also plays an important role in climate change adaptation for agriculture, forestry, environment and livestock. There is need of multidisciplinary research to resolve this problem and studies on climate change impacts and adaptation for any region should be shared among the researchers on a global scale to minimize the ill effects of climate change.

I am confident that the conference will provide right forum to national and international researchers, academicians, students, entrepreneurs and farming community to interact and involve in recent research work and innovations to spread their knowledge and work experience in the field of Agriculture, Forestry, Environment and Food Security with special emphasis on climate change and its impacts. Outcomes of the conference will be fruitful to cope up with climate change challenges.

I wish a grand success of the International Conference.

Dated: 17-09-2022

(Jeetendra Kumar)



प.सं./Ref. No.

च.नं.

मिति/Date: 02 September 2022

Message from Organizing Secretary's Desk

It gives me immense pleasure to welcome you all as an Organizing Secretary of the 4th International Conference on "Global Efforts on Agriculture, Forestry, Environment and Food Security (GAFEF-2022)" on 1-3 September 2022, which is being organized by the Agricultural & Environmental Technology Development Society (AETDS), U.S. Nagar, Uttarakhand, India, Institute of Forestry, Tribhuvan University, Pokhara Campus Pokhara, Nepal, Faculty of Agriculture (FoA), Agriculture and Forestry University (AFU), Rampur, Chitwan, Nepal, Forest Research Centre for Eco-rehabilitation, Prayagraj (U.P.), India, Gandaki University, Kaski, Nepal & in association with Institute of Root Biology, Yangtze University, China and Soil, Water & Environment Research Institute, Giza, Egypt at Institute of Forestry, Tribhuvan University, Pokhara Campus Pokhara, Nepal.

The theme, "Climate Change and Its Impact" is an auspicious occasion to assemble all stakeholders involved directly or indirectly in the fields related to Agriculture and Allied Science, the most impacted field of climate change. Climate change is real and its impacts may be irreversible if urgent measures are not taken. We have seen the devastating effects of extreme weather that resulted in economic loss and reduced quality of life. The most detrimental impacts of climate change for all south Asian countries will be on water resources and agriculture. Climate change induced adverse effects on agricultural land and production affect people's livelihoods, especially among the rural poor. Continuous research innovations and the implementation of adaptation and mitigation strategies are essential to reduce the impact of climate change. This conference brings together educators, researchers, as well as students from around the South Asian countries, providing them a networking platform to discuss ideas and research findings relative to climate change's impact on agriculture, and allied science. The various subthemes of the conference will offer many opportunities to delegate to learn new things and apply the same in their respective workplace. I hope that GAFEF-2022 will offer ample opportunities in sharing experiences, fostering research collaborations, and strengthening the friendship among scientists, academia, and institutes.

I look forward to welcoming you all to the beautiful city Pokhara, Nepal,

Santosh Marahatta, Ph.D.

Organizing Secretary



Ref: AETDS/SO/409

Date: 01.09.2022



From the Desk of the Chief Organising Secretary

It's indeed a matter of great pride and privilege to be chief organising secretary and welcome you to the fourth International Conference “**Global Efforts on Agriculture Forestry, Environment and Food Security (GAFEF; 2022)**” from **17th to 19th September; 2022**. The venue is the Institute of Forestry Tribhuvan University, Pokhara Campus, Pokhara, Nepal. The event is jointly organised by **Agricultural & Environmental Technology Development Society (AETDS) US Nagar, Uttarakhand, India**; Institute of Forestry, Tribhuvan University, Nepal; Faculty of Agriculture (FOA), Agriculture and Forestry University, Chitwan, Nepal; Forest Research Centre of Eco-rehabilitation, Payagraj, Uttar Pradesh, India; Gandaki University (GU), Pokhara, Nepal; in association with, Institute of Root Biology, Yangtze University, China; Soil, Water and Environmental Research Institute (SWERI), Agriculture Research Center (ARC), Giza, Egypt.

The world faces significant challenges such as; climate change, agricultural distress, habitat and biodiversity loss, the Covid-19 pandemic, health, agrarian distress, deforestation, food security and water scarcity. However, there are more unsung challenges, such as changes in consumption patterns and the increasing need for agroforestry products, redefining food, nutrition and food security. Therefore, there is a need for interaction among experts from diverse domains worldwide to address these challenges. The conference attempts to bring together researchers, scientists, academicians, scholars, students and entrepreneurs to discuss their latest research under different thematic areas that create an intersection with the agriculture sector.

I appreciate experts worldwide for their valuable time and willingness to share their wisdom through empirical evidence addressing different thematic areas of the conference.

I congratulate the GAFEF-2022 team for organising the conference.

I wish the conference a grand success.

Wajid Hasan, Ph.D., PDF

Chief Organising Secretary, GAFEF; 2022

Secretary, Agricultural and Environmental Technology Development Society (AETDS), U. S. Nagar, Uttarakhand, India

Krishi Vigyan Kendra, Jahanabad, Bihar Agricultural University, Bihar, India

4th International Conference on “*Global Efforts on Agriculture, Forestry, Environment and Food Security (Theme: Climate Change and Its Impact) (GAFF-2022)*”

CONTENTS

September 17-19, 2022

ISBN: 978-93-5659-453-1

S. No.	Titles and Authors	Page No.
1	A MODEL FOR IRRADIANCE RESPONSE ON PHOTOSYNTHETIC APPARATUS IN MANGO (<i>Mangifera indica</i>) LEAVES RAMWANT GUPTA ^{1,2} AND CHHEDI LAL VERMA ³	1
2	VERMITECHNOLOGY–AN EXCELLENT TOOL FOR ORGANIC AGRICULTURE ABDULLAH ADIL ANSARI	1
3	ASSESSMENT, REFINEMENT AND VALIDATION OF THE ECOFRIENDLY MANAGEMENT TECHNOLOGY FOR THE OF POD BORER, <i>Helicoverpa armigera</i> (Hubner) IN CHICKPEA WAJID HASAN	11
4	FEEDING PREFERENCE OF BANANA LEAF AND FRUIT SCARRING BEETLE, <i>Nodostoma subcostatum</i> (Jacoby) In Banana Germplasms FOUZIA BARI ¹ , WAJID HASAN ² , NILANJANA CHAUDHURY ³ AND S.K. SENAPATI ⁴	12
5	RELATIVE EFFICACY OF DIFFERENT INSECTICIDES AND BIOPESTICIDES ON APHID AND THEIR NATURAL ENEMIES BHAVNA VERMA ¹ AND WAJID HASAN ²	12
6	EFFECT OF INTER ROW SPACING WITH OR WITHOUT WEED CONTROL IN WHEAT (<i>Triticum aestivum</i> L.). F.S. ABD EL-SAMIE ¹ , EKRAM, A. MEGAWER ¹ , H.H.M. HUSSEIN ² , AND SARA, M. MOHAMED ¹	13
7	ASSESSING CLIMATE CHANGE POTENTIAL OF RECYCLING END-OF-LIFE PRODUCTS: AN LCA STUDY PRAKASH POKHREL*, SHENG-LUNG LIN	14
8	AMELIORATION OF WATER STRESS BY POTASSIUM FERTILISER UNDER HIGH TEMPERATURES ON THE OIL PALM GROWTH, CARBON ASSIMILATION, AND BIOCHEMICAL CHANGES TUAN SYARIPAH NAJIHAH, MOHD HAFIZ IBRAHIM, NURUL AMALINA MOHD ZAIN, ROSIMAH NULIT, PUTERI EDAROYATI MEGAT WAHAB	16
9	IMPORTANCE OF RICE BREEDING BIOFORTIFICATION FOR GRAIN ZN IMPROVEMENT AND FOOD SECURITY CALLEY DEBRA YASING, LUM MOK SAM AND MD. AMIRUL ALAM	16
10	TRICHODERMA: A MULTIFACETED FUNGUS FOR VERSATILE FUNCTIONALITIES BIRESWAR SINHA*, KOTA CHAKRAPANI, Ph. SHOBITA DEVI, L.N.K. SINGH	17
11	CONVERT THIS HUGE BIOMASS OF BANANA CROP RESIDUE INTO DIFFERENT VALUE-ADDED PRODUCTS LIKE FIBRE, LIQUID FERTILIZER AND VERMI-COMPOST	18

	SK SINGH* AND SHANKAR JHA**	
12	PLANT GROWTH PROMOTING RHIZOBACTERIA: MULTITASKING MICROBES FOR PLANT GROWTH AND DISEASE MANAGEMENT UNDER CHANGING CLIMATIC AND PESTICIDE SCENARIO GURURAJ SUNKAD	19
13	GENOME-WIDE ASSOCIATION STUDIES AND LINKAGE MAPPING FOR MAIZE IMPROVEMENT: A REVIEW NGUYEN TRUNG DUC^{1*}, VU VAN LIET¹, PHAM QUANG TUAN¹, NGUYEN THI NGUYET ANH¹, NGUYEN QUOC TRUNG¹	20
14	SUSTAINABLE DEVELOPMENT AND ENVIRONMENT OF BIOMASS FROM AGRICULTURE RESIDUES ABDEEN MUSTAFA OMER	20
15	DOUBLING THE FARMERS INCOME THROUGH INDO- ISRAEL CITRUS PRODUCTION TECHNOLOGY D.M. PANCHBHAI*, R.P. GAJBHIYE, Y.R. KHOBRADE, V.U. RAUT	48
16	EXPLORING THE DYNAMIC INTERACTION OF INSECT VECTOR AND PLANT VIRUSES ON MOLECULAR PRINCIPLES RABIYA BASRI^{1*}, MOHAMMAD AKRAM², ANKUR TRIPATHI³ AND WAJID HASAN⁴	56
17	EFFECT OF DIFFERENT BLENDS OF AROMATIC POWDERS ON QUALITY OF DRUMSTICK LEAF GREEN TEA POWDER BHUVANESHWARI G*, MADHUKARA², VASANT M. GANIGER³ AND RUDRESH D. L.⁴	57
18	VARIETAL EVALUATION OF STRAWBERRY IN INDO GANGETIC PLANE OF BIHAR RUBY RANI¹*, HIDAYTULLAH MIR, FEZA AHMAD¹, SANJAY SAHAY, KUMARI KARUNA AND PAWAN KUMAR	60
19	NEW RECORD OF <i>Metanastria hyrtaca</i> (Cramer, 1779) (LEPIDOPTERA: LASIOCAMPIDAE), A DEFOLIATOR PEST, FROM CHAKRATA BLOCK, DEHRA DUN, UTTARAKHAND (INDIA) WITH HOST PLANTS AND CONTROL MEASURES AKHLAQ HUSAIN¹ AND WAJID HASAN²	62
20	MINING AND LAND DEGRADATION IN COAL MINED LANDSCAPE: RESTORATION PATHWAYS FOR DEVELOPMENT OF RESILIENT ECOSYSTEMS IN CENTRAL INDIA SL SWAMY¹	62
21	STRATEGIES TO COMBAT CLIMATE CHANGE FOR PULSE PRODUCTION ANITA BABBAR	64
22	A REVIEW OF THE EFFECT OF CLIMATE CHANGE AND VARIABILITY ON AGRICULTURE IN BANGLADESH	67

	A K M KANAK PERVEZ*, MD. MOHIUDDIN SHEIKH, M. ARMANUL HAQUE, MD. ABU SAYEM AND UTTAM KUMAR KABIRAJ	
23	INFORMATION COMMUNICATION TECHNOLOGY FOR TRANSFER OF TECHNOLOGY IN AGRICULTURE – A WAY FORWARD RAJESHWARI N*, PRAVEEN R SHINDHE, SUREKHA SANKANAGOUDAR, RAGINI MODI AND SPOORTHI K N	69
24	DIVERSIFICATION OF AGRICULTURE ON FOOD, NUTRITION AND HEALTH SECURITY VIJAYAKHADER	70
25	SPATIO-TEMPORAL DISTRIBUTION OF DENGUE VECTOR AND ITS VULNERABILITY USING GIS: A CASE STUDY OF JAIPUR CITY, INDIA #PRAVEEN KUMAR RAI ¹ , PRIYANKA ROY ² , SURAJ KUMAR SINGH ² , SHRUTI SINGH ²	74
26	DESIGNING OF INTEGRATED FARMING SYSTEMS USING MULTI-CRITERIA DECISION MAKING AND OPTIMIZATION METHODOLOGY FOR SUSTAINABLE DEVELOPMENT OF SMALL AND MARGINAL FARMERS OF ASIA U.K. BEHERA ¹ , PRATISHRUTI BEHERA ² AND BUSSA BHARGAVI ³	75
27	NANOTECHNOLOGY IN WASTEWATER MANAGEMENT: A NEW PARADIGM FOR WASTEWATER TREATMENT SHANKRAMMA K	80
28	UNDERSTANDING STRATEGIC WEED MANAGEMENT IN DIRECT SEEDED RICE - A REVIEW R R UPASANI* AND SHEELA BARLA**	80
29	RESILIENT PRACTICES FOR USE OF RENEWAL ENERGY TO NATURAL RESOURCE MANAGING AS BIOGAS PLANT TO SELF-RELIANT INDIA R.K. PRAJAPATI, B.S. KIRAR, U.S. DHAKAD, I.D. SINGH AND JAIPAL CHHIGARHA	83
30	EXPLORING SOCIAL ENGINEERING FOR INNOVATIVE PEST MANAGEMENT BADAL BHATTACHARYYA	84
31	IMPACT ON CLIMATIC STRESS MANAGEMENT OF RESILIENT PRACTICES FOR IN-SITU MOISTURE CONSERVATION UNDER BUNDELKHAND AGRO-CLIMATIC ZONE B.S. KIRAR, R.K. PRAJAPATI, JAIPAL CHHIGARHA AND I.D. SINGH	88
32	ROLE OF PKV MINI DAL MILL IN RURAL ENTREPRENEURSHIP DEVELOPMENT N.V. SHENDE, R. D. VAIDKAR, V. K. KHOBARKAR AND D. K. NEMADE	89
33	EFFECT OF ORGANIC MANURES AND BIOFERTILIZERS ON GROWTH AND YIELD OF WATERMELON (<i>Citrullus lanatus</i> Thunb.)	90

	ARVIND M. SONKAMBLE*, ADITYA MAPARI, SURENDRA R. PATIL AND VISHAL D. TAYADE	
34	DOMESTICATION OF NATIVE WILD FRUITS FOR DIVERSIFICATION IN MAHARASHTRA REGION OF INDIA SURENDRA R. PATIL ¹ , ARVIND M. SONKAMBLE ² AND ABHAY P. GEDAM ³	90
35	CITRUS DECLINE IN HILL AND MOUNTAINOUS ECOSYSTEM OF WEST BENGAL SAJEED ALI, B. R. SHARMA, T.S. GHIMIRAY, S. GURUNG, H. K. TARAFDER, S. BASKEY, BISWAJIT PATRA, BANDAN THAPA AND ANWESH RAI	91
36	WEED CROPS TO FOOD CROPS; A TIMELY NEED APPROACH TO ACHIEVE FUTURE FOOD SECURITY AND SUSTAINABILITY MD. AMIRUL ALAM, NADIRAH T. A. AND SALLEH, M.	93
37	COLLECTION, CONSERVATION AND PROFILING OF MAIZE GENETIC RESOURCES TO REDESIGN MAIZE AS A NUTRICEREAL IN FOOD SECTOR SURINDER SANDHU, JS CHAWLA, GAGANDEEP SINGH, YOGESH VIKAL AND TOSH GARG	95
38	CLIMATE CHANGE IMPACTS AND HEALTH RISKS ZOYA AKRAMI*, A. KHAN2*, SHAFIQUE ZEHRA3, SANYUKTA MANDAL4, ASHUTOSH KUMAR5, TARANNUM ARA6, DIKSHA BHARATI7, BINIT BHASKAR8	96
39	<i>OSCHEIUS</i> : A NEW ENTOMOPATHOGENIC NEMATODES RASHID PERVEZ	99
40	HYDROPONIC FODDER AS AN ALTERNATE TO CONVENTIONAL GREEN FODDER FOR SUSTAINABLE RABBIT PRODUCTION SHANMUGA SUNDARAM. A, VENKATARAMANAN, R, RAJKUMAR. K, AND MEENAKSHI SUNDARAM. S	99
41	EVALUATING THE EFFECT OF COMBINATION OF ESSENTIAL OILS ON RUMEN METHANE PRODUCTION THROUGH <i>IVGPT</i> RAJKUMAR. K ^{1*} , KARUNAKARAN. R ¹ , BHARATHIDHASAN. A ¹ , TENSINGH GNANARAJ. P ² AND VIJAYARANI. K ³	105
42	COSTS AND BENEFITS OF TWO OIL PALM PLANTATIONS LOCATED IN UGANDA AND MALAYSIA BONNY KAYONDO, MOHAMADU BOYIE JALLOH, IIMAS ABDUROFI, NUR AAINAA BINTI HASBULLAH, PARAMANANTHAN SELIAH	108
43	ASSESSMENT OF RESILIENCE IN RELATION TO PHYSIOLOGICAL AND BEHAVIOURAL PATTERNS OF PREPARTUM THARPARKAR (<i>Bos indicus</i>) AND VRINDAVANI CROSSBRED COWS UNDER TROPICAL CLIMATIC CONDITION VANDANA ¹ , BRIJESH KUMAR ² , MUKESH SINGH ¹ , G.K. GAUR ¹ , KALPENDRA KOHLI ² , PRADEEP CHANDRA ² , MED RAM VERMA ³ AND	108

	TRIVENI DUTT ¹	
44	COMPARATIVE STUDIES ON VARIOUS PHYSICAL AND SUCKLING ACTIVITIES OF VRINDAVANI AND THARPARKAR CALVES DURING INITIAL 6 HR AFTER CALVING UNDER FLOOR ENRICHED WITH RUBBER MATTRESS VANDANA ¹ , BRIJESH KUMAR ² , MUKESH SINGH ¹ , G.K. GAUR ¹ , PRADEEP CHANDRA ² , KALPENDRA KOHLI ² , S.K. SHANDILYA ⁴ , MED RAM VERMA ³ AND TRIVENI DUTT ¹	111
45	SERUM AMH CONCENTRATION AS A POTENTIAL PREDICTOR OF TOTAL ANTRAL FOLLICLE POPULATION, SUPEROVULATORY RESPONSE, AND EMBRYO QUALITY IN SAHIWAL CATTLE PRADEEP CHANDRA, BRIJESH KUMAR ^{A*} , SUSHOBHIT SINGH, KALPENDRA KOHLI, VANDANA, BHAGIRATHI, KURHE ROHIT SATISH, ATHIDI LOKAVYA GANGULA, S.K SINGH, HARENDRA KUMAR AND K. NARAYANAN	113
46	MORPHOLOGICAL VARIABILITY IN <i>Hibiscus cannabinus</i> DUE TO IONIZING IRRADIATION (CO ⁶⁰), AND ESTIMATION OF GAMMA-RAY LETHAL DOSE 50 (LD ₅₀) FOR MUTATION BREEDING MD. MUKUL MIA ^{1*} , MD. HARUN OR RASHID ¹ , IFFAT JAHAN NUR, MD. FIROZ MORTUZA ³ , ARIFATUN NAHAR ³ , MD. GOLAM MOSTOFA ¹ , NARGIS AKTER ²	115
47	SCREENING OF SALT-TOLERANT TOSSA JUTE GENOTYPES AT GERMINATION STAGE IN SAND-BASED PETRI-PLATES, AND GENETIC ANALYSES OF YIELD ATTRIBUTING MORPHOLOGICAL TRAITS MD. MUKUL MIA ^{1*} , NARGIS AKTER ²	116
48	IONIZING IRRADIATION (CO ⁶⁰) OF <i>Hibiscus sabdariffa</i> FOR MORPHOLOGICAL VARIABILITY, AND ESTIMATION OF GAMMA RAY LETHAL DOSE 50 FOR MUTATION BREEDING MD. MUKUL MIA ^{1*} , MD. HARUN OR RASHID ¹ , IFFAT JAHAN NUR, MD. FIROZ MORTUZA ³ , ARIFATUN NAHAR ³ , MD. GOLAM MOSTOFA ¹ , NARGIS AKTER ²	117
49	ROLE OF FEEDING <i>MORINGA OLIEFERA</i> DRIED LEAVES IN SMALL RUMINANTS AHMAD FAHIM ^{1*} AND NAZIM ALI ²	118
50	<i>Aloe vera</i> GEL COATING FOR SUPPRESSING RIPENING CHANGES IN ASIAN PEARS T. ADHIKARY & PANKAJ DAS	124
51	FIELD EVALUATION OF GENOTYPES AGAINST RED ROT, SMUT AND WILT DISEASES OF SUGARCANE MD. MINNATULLAH*, PRIYA SINGH, SHIVA PUJAN SINGH, AARADHNA AND SANSKRITI	125
52	COSTS AND BENEFITS OF TWO OIL PALM PLANTATIONS LOCATED IN UGANDA AND MALAYSIA	126

	BONNY KAYONDO, MOHAMADU BOYIE JALLOH, IIMAS ABDUROFI, NUR AAINAA BINTI HASBULLAH, PARAMANANTHAN SELIAH	
53	ROLE OF PKV MINI DAL MILL IN RURAL ENTREPRENEURSHIP DEVELOPMENT N.V. SHENDE, R. D. VAIDKAR, V. K. KHOBARKAR AND D. K. NEMADE	126
54	SUBMERGENT RICE VARIETIES: A POTENTIAL OPTION FOR FLOOD PRONE AREA A.K. TRIPATHI ¹ , M. THOITHOI DEVI ² AND BAGISH KUMAR ²	127
55	POPULARIZATION OF IMPROVED SHORT DURATION RICE VARIETY TELANGANA SONA (RNR 15048) THROUGH FRONTLINE DEMONSTRATIONS IN NALGONDA DISTRICT, TELANGANA SHANKAR, M* ¹ ., AARIFF KHAN, M.A ¹ ., BHARAT, T ¹ ., PALLAVI, S ¹ ., BALAZZI NAAIK, R.V.T ² ., SUMALINI, K ³ ., RAVINDER NAIK, V ³ AND SHANKARAIH, M ¹ .	128
56	NATURE-BASED SOLUTIONS FOR AGRICULTURAL SUSTAINABILITY, FOOD SECURITY AND CLIMATE RESILIENCE IN NEH REGION, INDIA SANJAY-SWAMI	129
57	RESPONSE OF SOME NEW MAIZE HYBRIDS TO SOME NANO FERTILIZERS UNDER WATER STRESS CONDITIONS. F.S. ABD EL-SAMIE ¹ , EKRAM, A. MEGAWER ¹ , H.H.M. HUSSEIN ² , AND SARA, M. MOHAMED ¹	129
58	SEED QUALITY ENHANCEMENT THROUGH ORGOPRIMING IN FINGER MILLET (<i>Eleusine coracana</i> L.) V. SRIDEVI*, S. RAGHUL, T. RAMANADANE AND A. KAMATCHI	130
59	CLIMATE CHANGE POLICY FRAMEWORK IN AGRICULTURE AND ITS INTEGRATION NEED IN NEPAL SHREE BHAGAVAN THAKUR ¹ SRISTI KHANAL ²	132
60	INFORMATION COMMUNICATION TECHNOLOY – A WAY FORWARD FOR TRANSFER OF TECHNOLOGY OF AGRICULTURE RAJESHWARI N, PRAVEEN R SHINDHE, SUREKHA SANKANAGOUDAR, RAGINI MODI AND SPOORTHI K N	135
61	APPLICATION OF <i>PARABURKHOLDERIA</i> AND <i>DELFTIA</i> TO MITIGATE CADMIUM TOXICITY IN RAPESEED MD. RAKIB HOSSAIN RAIHAN, MIRA RAHMAN AND MIRZA HASANUZZAMAN*	142
62	MITIGATION OF SALT STRESS IN SOYBEAN BY THE APPLICATION OF <i>Bacillus subtilis</i> MIRZA HASANUZZAMAN ¹ *, MD. RAKIB HOSSAIN RAIHAN ¹ , FARZANA NOWROZ ¹ AND MASAYUKI FUJITA ²	143
63	AN ECONOMIC ANALYSIS OF VEGETABLE PRODUCTION IN RAICHUR DISTRICT OF KARNATAKA	144

	*AMRUTHA T. JOSHI, SATISHKUMAR M. SIDRAMAYYA AND MANJUNATH DODAMANI	
64	INFLUENCE OF NOZZLE TYPE AND SPRAY VOLUME ON BISPYRIBAKE SODIUM EFFICACY IN PADDY WEED ECOSYSTEM JEETENDRA KUMAR^{1*}, WAJID HASAN¹, SHOBHA RANI ¹ AND R.K. SOHANE²	144
65	CONSERVATION AGRICULTURE: A NEW PARADIGM FOR IMPROVING SYSTEM PRODUCTIVITY AND RESOURCE USE EFFICIENCY IN DIVERSIFIED CROPPING SYSTEM T. PANDIARAJ, PRAKASH YADAV AND D.K. SINGH	146
66	NATURAL FARMING: A VIABLE TOOL FOR SUSTAINABLE FUTURE AGRICULTURE TOWARDS A HEALTHY NATION PRAKASH YADAV, T. PANDIARAJ , D.K. SINGH AND VIMLESH KUMAR	148
67	INNOVATIVE VEGETABLE PRODUCTION IN UTTARAKHAND HILLS ANITA SINGH,	150
68	NUTRITIONAL ASPECT OF FOOD PROCESSING AND VALUE ADDITION IN FOOD PRODUCTS ANITA SINGH ¹ AND SANGEETA²	160
69	BIOENERGY, ENVIRONMENT AND SUSTAINABLE DEVELOPMENT ABDEEN MUSTAFA OMER*	161
70	OUT SCALING STRATEGIES FOR CLIMATE RESILIENT TECHNOLOGIES UJJWAL KUMAR, ROHAN KUMAR RAMAN, ABHAY KUMAR & MOHAMMAD MONOBRULLAH	164
71	IMPACT OF CLIMATE CHANGE ON INSECT-PESTS MD. MONOBRULLAH	168
72	FUTURE OF DAIRY CATTLE INDUSTRY IN AND AROUND BIHAR IS BY MEGA UTILIZATION OF SEXED SORTED SEMEN SUMIT SINGHAL^{1*}, A K SINGH¹², AJAY ASWAL, NARENDRA KUMAR, G D SINGH, S K GANGWAR AND A KUNDU	171
73	NATURE-BASED SOLUTIONS FOR AGRICULTURAL SUSTAINABILITY, FOOD SECURITY AND CLIMATE RESILIENCE IN NEH REGION, INDIA SANJAY-SWAMI	176
74	DECENTRALIZED SYSTEMS FOR WASTE WATER & SOLID WASTE MANAGEMENT VIKRAM DESHMUKH (PUNE, MAHARASHTRA INDIA)	181

75	EFFECT OF ELEVATED LEVELS OF ENVIRONMENTAL CONDITIONS ON <i>Fusarium oxysporum</i> f. sp. <i>Pisi</i> INCITING WILT OF PEA KOTA CHAKRAPANI, BIREWASR SINHA, BIJEETA TANGJAM, PH. SHOBITA DEVI, LNK SINGH	187
76	PRECISION POULTRY FARMING TO IMPROVE PRODUCTIVITY ANIL KUMAR AND ANKIT SHARMA	188
77	THE ROLE OF MYCORRHIZA IN FOOD SECURITY AND THE CHALLENGE WITH CLIMATE CHANGE MOINUDDIN¹, FAROOQ A. KHAN² AND WAJID HASAN³	194
78	CURRENT SCENARIO OF SUSTAINABLE AGRICULTURE WITH ORGANIC FARMING IN INDIA MOINUDDIN¹ AND WAJID HASAN²	195
79	EFFECT OF HIGH YIELDING VARIETIES ON MUSTARD CULTIVATION IN ARAJILINE BLOCK OF VARANASI DISTRICT OF UTTAR PRADESH. RAKESH KUMAR	195
80	EFFECT OF BIOCHAR AND FYM AND ITS INTERACTION ON PHYSICO-CHEMICAL PROPERTIES OF SALT AFFECTED SOIL ASTHA PANDEY¹, M.S. JAKASANIYA², DEVENDRA INWATI³	196
81	IMPACT OF CONSERVATION AGRICULTURE PRACTICES ON GROWTH, YIELD, AND QUALITY OF RICE CROP UNDER RICE-WHEAT CROPPING IN EASTERN INDO-GANGETIC PLAINS OF INDIA V. KUMAR¹, M. KUMAR¹, S. K. SINGH¹, R. K. JAT², ATUL KUMAR³ AND S. K. CHANDRA¹	198
82	SOIL SAMPLING WITH DRONES AND ITS AUGMENTED REALITY IN CLIMATE RESILIENT AGRICULTURE RAJKISHORE KUMAR AND ATUL KUMAR	198
83	APPLICATION OF ARTIFICIAL NEURAL NETWORKS TO IDENTIFY PESTS AND DISEASES IN AGRICULTURE JYOTHI V	199
84	ASSESSMENT OF SOIL QUALITY INDICATORS UNDER THE DOMINANT LAND USE SYSTEM OF BIHAR ATUL KUMAR¹, SHWETA SHAMBHAVI¹, RAJIV RAKSHIT¹, VIJAY KUMAR², GOPAL KUMAR¹ AND SHRIMAN KUMAR PATEL¹	200
85	INTERACTION EFFECT OF POTASSIUM AND SULFUR ON GROWTH AND YIELD ATTRIBUTING CHARACTERS IN JUTE CROP VAR. JR0524”	200

	VINAY KUMAR, RAJKISHORE KUMAR ¹ , KUNAL PRATAP SINGH AND DIWAKAR PASWAN	
86	SYNCHRONIZED APPROACH OF MICROBES MEDIATED WITH CHELATED MICRONUTRIENT NUTRIPRIMING TO AUGMENT FE AND ZN CONTENT IN RICE AND LENTIL BASED CROPPING SYSTEM GOPAL KUMAR ^{1*} , PRIYANKA KUMARI ² , KASTURIKASEN BEURA ¹ , MAHENDAR KUMAR SINGH ¹ , SUNIL KUMAR ¹ , ATUL KUMAR ¹ AND AMIT KUMAR PRADHAN ¹	201
87	ROLE OF INDIGENOUS TECHNICAL KNOWLEDGE (ITK) IN THE PRESENT DAY PANKAJ YADAV ¹ AND NEELAM KUMARI ²	202
88	DETECTION OF POMEGRANATE LEAF DISEASE USING MULTICLASS ROBUST ENERGY BASED LEAST SQUARES TWIN SUPPORT VECTOR MACHINE (RELS-TSVM) CLASSIFIER RIYAJ UDDIN KHAN, SHAIK RAFI AHAMED, M K BHUYAN	202
89	EFFECT OF ORGANIC PRODUCTS ON HUMAN HEALTH SHAKSHI DUBEY AND MOINUDDIN	203
90	ASSESSMENT OF SOIL QUALITY OF DIFFERENT LAND USE SYSTEMS IN SOUTHERN TRANSECT OF BENGALURU ALTAF KUNTOJI ¹ , SUBBARAYAPPA C. T., ² SATHISH A., ³ RAMAMURTHY V. ⁴ AND MALLESHA B. C. ⁵	203
91	DISTRIBUTION AND ABUNDANCE OF <i>PROSOPIS JULIFLORA</i> (SWARTZ) DC. IN COIMBATORE, TAMIL NADU MONIKA SINGH ^{A*} , AND RAJASEKARAN ARUNACHALAM ^A	204
92	ASSESSMENT OF GENETIC VARIABILITY, HERITABILITY AND GENETIC ADVANCE IN COWPEA [<i>Vigna unguiculata</i> (L.)] Genotypes CHAITRA ¹ , HASAN KHAN [*] , B.V. TEMBHURNE, B. SUVARNA AND A. AMAREGOUDA	204
93	STUDIES ON ASSOCIATION SHIP BETWEEN SEED YIELD AND ITS ATTRIBUTING TRAITS IN COWPEA [<i>VIGNA UNGUICULATA</i> (L.)] GENOTYPES CHAITRA ¹ , HASAN KHAN [*] , B.V. TEMBHURNE, B. SUVARNA AND A. AMAREGOUDA	205
94	ANALYTICAL STUDY OF URBAN GREEN SPACES THEIR ROLE TO IMPROVE URBAN MICROCLIMATE USING LANDSAT 8 OLI AND TIRS DATA THROUGH ASSESSMENT OF LAND SURFACE TEMPERATURE RELATION WITH NORMALIZED SATELLITE INDICES AND ESTIMATION OF SPATIO-TEMPORAL TRENDS	205

	IN TEMPERATURE AMONG VARIOUS LAND USE LAND COVER CLASSES OF MUMBAI CITY PRIYANKA SS, A. RAJASEKARAN AND P. AMALADAS	
95	KNOWLEDGE, PERCEPTION, AND SATISFACTION OF PADDY FARMERS ON THE USE OF INFORMATION AND COMMUNICATION TECHNOLOGY (ICT) TOOLS IN JHAPA, NEPAL U.P. SIGDEL, K.N. PYAKURYAL, D. DEVKOTA³, G. P. OJHA	206
96	CYANOBACTERIA AS A BIOREACTOR FOR THE AgNPs SYNTHESIS AND THEIR APPLICATIONS SHAHEEN HUSAIN	207
97	ESTIMATION OF VARIABILITY AND ASSOCIATION PARAMETERS IN F₂ GENERATION OF THE CROSS GKVK16×ICGV91114 IN GROUNDNUT (<i>Arachis hypogaea</i> L.) FOR YIELD AND WATER USE EFFICIENCY RELATED TRAITS H. C. SOWMYA, D. L. SAVITHRAMMA AND H. C. LATHA	207
98	ASSESSMENT OF VARIABILITY AND ASSOCIATION IN F₂ SEGREGATING GENERATION OF THE CROSS GKVK13×KCG2 IN GROUNDNUT (<i>Arachis hypogaea</i> L.) FOR YIELD AND WATER USE EFFICIENCY RELATED TRAITS H. C. SOWMYA, D. L. SAVITHRAMMA AND H. C. LATHA	208
99	EXPLORING THE DYNAMICS OF VIRUS-VECTOR RELATIONSHIP AND GENETIC DIVERSITY OF BEGOMOVIRUS AND WHITEFLY, <i>Bemisia tabaci</i> (Gennadius), POPULATIONS OF INDIA ARCHANA ANOKHE^{1*}, S. SUBRAMANIAN¹, PREETI RAMTEKE²	209
100	SURVEY, IDENTIFICATION AND SELECTION OF BUD MUTATION IN APPLE (<i>Malus x domestica</i> Borkh.) IN HIMACHAL PRADESH (INDIA) HEERENDRA PRASAD*, K KUMAR, DINESH SINGH THAKUR, JAYESH GARG, VAIVABH CHITTORA, ARCHANA SHARMA	210
101	USE OF GEOSPATIAL TOOLS FOR MAPPING OF GEOGRAPHICAL INDICATORS OF AGRICULTURE IN HIMACHAL PRADESH AASHIMA SHARMA*, SOMDEV SHARMA, AND VIKAS KUMAR SHARMA	210
102	NANOFERTILIZERS: THEIR EFFECT ON CROP PRODUCTION AND SOIL HEALTH ANKITA SHARMA* SWAPANA SEPEHYA, ANIL KUMAR AND RAKESH SHARMA	211
103	DEFENSE MECHANISM OF HONEYBEES AGAINST DISEASES AND ENEMIES	211

	BABITA KAUSHAL AND HEERENDRA PRASAD	
104	ASSESSMENT OF SOIL BIOLOGICAL PROPERTIES UNDER DIFFERENT LAND USES IN BAROG-DHILLON WATERSHED IN SOLAN DISTRICT OF HIMACHAL PRADESH DINESH KUMAR* AND RAJEEV DHIMAN	212
105	RESPONSE OF FOLIAR SPRAY OF IRON IN STRAWBERRY (<i>FRAGARIA</i> × <i>ANANASSA</i> DUCH.) CV. WINTER DAWN LOKESH KUMAR AND H.L. BAIRWA	213
106	CHARACTERIZATION OF SEEDLING GENOTYPES OF WALNUT FOR BETTER HORTICULTURAL TRAITS IN SOLAN AND SIRMOUR DISTRICTS OF HIMACHAL PRADESH PARAMJEET SAJWAN*, GIRISH SHARMA, DEEPIKA NEGI, HEERANDERA PRASAD AND KIRAN THAKUR	213
107	ROLE OF ROOTING MEDIA IN PRODUCTION OF QUALITY PLANTING STOCK SACHIN VERMA	214
108	PREPARATION AND CHARACTERIZATION OF MODIFIED REDMUD FOR ARSENIC REMEDIATION SIYARAM MEENA*, KAPIL A. CHOBHE, K.M. MANJIAH, S.P. DATTA, CHINMAYEE BEHERA, RAVI SAINI	214
109	STATUS OF SOIL ORGANIC CONTENT OF SOILS UNDER VEGETABLE CULTIVATION IN SUB-MONTANE AND SUBTROPICAL ZONE OF HIMACHALPRADESH SWAPANA SEPEHYA¹, DIXIT¹, ANIL KUMAR¹, RAKESH SHARMA¹ AND DEEPA SHARMA²	215
110	APPLICATION OF NANO-TECHNIQUES IN VEGETABLE CULTIVATION: POTENTIAL AND LIMITATIONS ASHIMA CHAUDHARY AND HEERENDRA PRASAD	215
111	HUNDRED YEARS OF GARLIC PRODUCTION OF INDIA JAYESH GARG, HEERENDRA PRASAD AND SHIVANI SHARMA	216
112	BIOTECHNOLOGICAL INTERVENTIONS IN WOOD INDUSTRIES RAVEENA THAKUR*, BHUPENDER DUTT, RAJNEESH KUMAR AND ROHIT SHARMA	217
113	EFFECT OF TRAINING SYSTEMS AND SPACING LEVELS ON VEGETATIVE AND QUALITATIVE CHARACTERS OF TOMATO (<i>Solanum lycopersicum</i> L.) UNDER CONTROLLED CONDITIONS RUKSANA*, AMIT SAURABH AND VEDIKA SHARMA	217

114	APPLICATION OF ARTIFICIAL INTELLIGENCE IN INSECT PEST MANAGEMENT SAKSHI SHARMA* AND SAPNA KATNA	218
115	OFF-SEASON VEGETABLE PRODUCTION: IMPACT ON DIVERSIFICATION AND FARM INCOME SHIVANI SHARMA* JAYESH GARG AND HEERENDRA PRASAD	219
116	THE DEVELOPMENT OF AGRICULTURAL VALUE THROUGH EFFECTIVE SUPPLY CHAIN MANAGEMENT SHIVANI SINGH* AND KRISHAN KUMAR RAINA	219
117	VEGETABLE DIVERSIFICATION: A BOON FOR INCREASING FARMERS INCOME IN HILLS SHRADDHA* AND BHARDWAJ RK	220
118	BIOFORTIFICATION OF VEGETABLES FOR NUTRITIONAL SECURITY SPARSH MADAIK, JAYESH GARG AND HEERENDRA PRASAD	221
119	ESTIMATION OF SOIL ORGANIC CARBON ALONG AN ALTITUDINAL GRADIENT OF <i>PINUS ROXBURGHII</i> FORESTS IN THE GARHWAL HIMALAYA, INDIA * ¹ AMIT KUMAR, ² MUNESH KUMAR, ³ TARUN KUMAR THAKUR	221
120	STANDARDIZATION OF BUDDING TECHNIQUES FOR PROPAGATION OF SWEET CHERRY (<i>Prunus avium</i> L.). POOJA AND HEERENDRA PRASAD	222
121	IMPACT OF AGRONOMICAL APPROACHES ON GROWTH, YIELD, AND ECONOMICS OF BELL PEPPER (<i>Capsicum annuum</i> L.) var. SOLAN BHARPUR UNDER MID-HILLS OF HIMACHAL PRADESH PRIYANKA BIJALWAN* ¹ , SHILPA ² , YR SHUKLA ³ AND MANISH CHAUHAN ³	223
122	GROWTH, YIELD AND NITROGEN USE EFFICIENCY OF DIFFERENT RICE GENOTYPES UNDER VARIABLE NITROGEN RATES RAVI SAINI ¹ *, K.M. MANJIAH ² , KAPIL A. CHOBHE ³ , SIYARAM MEENA ¹	223
123	NORTH-WESTERN HIMALAYAS AS A REPOSITORY FOR INDUSTRIALLY IMPORTANT MEDICINAL HERBS, AND COMPREHENSIVE INSIGHT OF MEDICINAL PLANT BIOTECHNOLOGY VIS-A-VIS TO THEIR CONSERVATION AND BIOACTIVE COMPOUNDS HARNESSING KAMAL THAKUR*, CHANCHAL KUMARI, ANAMIKA THAKUR, VINAY KUMAR, RAJNISH SHARMA, PARUL SHARMA	224

124	PRODUCTIVITY POTENTIAL OF DIFFERENT MEDICINAL PLANTS UNDER PEACH BASED HORTI-MEDICINAL SYSTEM OF AGROFORESTRY VIPIN KUMAR	225
125	VALUE CHAIN MANAGEMENT OF FRUITS, VEGETABLES AND MINOR FOREST PRODUCE IN MANDI AND KULLU DISTRICTS OF HIMACHAL PRADESH AMAN SHARMA AND KRISHAN KUMAR RAINA	225
126	EVALUATION OF BOTANICALS IN MINIMIZING SEED- BORNE FUNGI OF WHEAT IN IN-VITRO STUDY NEHA PATHAK*, UMA SHARMA AND RUCHI AGRAWAL	226
127	ANTIMICROBIAL PROPERTIES OF LEAVES & STEM EXTRACTS OF <i>Ocimum sanctum</i> (Lamiaceae) Against Some Pathogenic Bacteria UMA SHARMA, RAJENDRA SHARMA, SEEMA BHADAURIA AND NEHA PATHAK	227
128	IN VITRO MUTAGENESIS FOR SALINITY TOLERANCE IN BANANA (<i>Musa paradisiaca</i> L.) cv. GRAND NAINÉ RAJNI RAJAN ^{1,2*} AND M. FEZA AHMAD ¹	227
129	PHYSICO-CHEMICAL ANALYSIS OF DRINKING WATER, WATER SEWAGE AND SOIL OF GLASS INDUSTRIAL AREA OF FIROZABAD DISTRICT IN UTTAR PRADESH, INDIA RAJAN KUMAR VERMA ¹ , MANISH KUMAR ² AND AKHILESH KUMAR ³	228
130	EFFECT OF ZINC MANAGEMENT PRACTICES ON GROWTH, YIELD AND ECONOMICS IN TRANSPLANTED RICE (<i>oryza sativa</i> L.) UNDER PARTIALLY RECLAIMED SALT-AFFECTED SOIL DINESH KUMAR ¹ , PRASHANT SINGH ² AND ARVIND ¹	228
131	RESPONSE OF SOME NEW MAIZE HYBRIDS TO SOME NANO FERTILIZERS UNDER WATER STRESS CONDITIONS. F.S. ABD EL-SAMIE ¹ , EKRAM, A. MEGAWER ¹ , H.H.M. HUSSEIN ² , AND SARA, M. MOHAMED ¹	229
132	THERMAL PRESSURES AT HIGH TEMPERATURES ARE USED IN AU (GOLD) FOR EQUATION OF STATE (EOS) RAKESH KUMAR,	230
133	ANTI-DIABETIC MEDICINAL PLANT USED IN TRADITIONAL MEDICINE 1VIJAY KUMAR SINGH, 2MANISH KUMAR AND MANISH MAHESHWARI	230
134	PHYTOCHEMICAL PROFILING AND GC-MS ANALYSIS OF AQUEOUS METHANOL FRACTION OF FIELD RESISTANT SOYBEAN LEAVES EXTRACT AGAINST <i>Spodopetra litura</i> and <i>Spilosoma obliqua</i> ANCHALA NAUTIYAL	231

135	A STUDY ON COMPARISON OF COGNITIVE DEVELOPMENT OF CHILDREN ACROSS THE PLACE OF RESIDENCE SANGEETA SIDOLA	231
136	ZIKA VIRUS AS A GLOBAL THREAT: A SYSTEMATIC REVIEW ON CURRENT UPDATES AMARPAL SINGH BHADAURIYA	232
137	INFLUENCE OF CHEMICAL WEED MANAGEMENT PRACTICES ON NUTRIENTS UPTAKE AND YIELD OF HIGH-DENSITY PLANTING COTTON IN <i>VERTISOL</i> OF NORTHERN KARNATAKA KAMBLE ANAND SHANKAR ¹ , CHANNABASAVANNA, A. S. ² , AJAYAKUMAR ³ , M. Y., AND KOPPALKAR B. G. ⁴ .	232
138	ROLE OF REMOTE SENSING AND GEOGRAPHIC INFORMATION SYSTEM IN SUSTAINABLE DEVELOPMENT B USHASRI ¹ , T GIRIDHARA KRISHNA ² , KV NAGA MADHURI ³ , Y REDDIRAMU ⁴ AND B RAVINDRA REDDY ⁵	233
139	INFLUENCE OF BIO-PRIMING ON SEED QUALITY OF CHILLI (<i>Capsicum annuum</i> L.) KISHORKUMAR, G. K ¹ , RAVEENDRA JAWADAGI ² , SHIVAYOGI RYAVALAD ³	234
140	QUANTITATIVE ANALYSIS OF ESSENTIAL INGREDIENTS, NUTRACEUTICAL, AND TRACE ELEMENTS IN HERBAL INFUSION C. S. SANWAL ¹ , *A.K. BHANDARI ¹ , RAKESH BISHT ¹ , NARAYAN SINGH ² , M. BAUNTHIYAL ³	234
141	AGROFORESTRY SYSTEMS FOR ENHANCING RESOURCE USE EFFICIENCY AND PRODUCTIVITY IN SEMI-ARID AREAS N. KAUSHIK* AND KAJAL MEHTA	235
142	BETA-GLUCAN FROM EDIBLE MUSHROOMS AS FUNCTIONAL BIOMATERIAL SUHANI SAJAD* AND JAGMOHAN SINGH	237
143	EFFECT OF FEEDING HYDROPONIC HORSEGRAM SPROUTS ON GROWTH PERFORMANCE OF KONKAN KANYAL GOATS DIVYA KOKANI ^{1*} , B. G. DESAI ² , D. J. BHAGAT ² , V. S. DANDEKAR ³ , J. S. DHEKALE ³	238
144	EFFECT OF GIBBERELIC ACID ON MYCELIAL GROWTH OF <i>Hericium erinaceus</i> STANZIN DISKIT ¹ , SACHIN GUPTA ¹ AND MONI GUPTA ²	238
145	RESPONSE OF BUD INDUCTION IN PINEAPPLE OVER APPLIED PLANT BIOREGULATORS AFIYA R S* AND SENTHILKUMAR S	239
146	CLIMATE CHANGE AND MICROORGANISMS IN AGROECOSYSTEMS. THOKCHOM DORENCHAND SINGH	239
147	PERFORMANCE AND EVALUATION OF DIFFERENT TREE SPECIES UNDER AGRI-SILVICULTURE P. D. RAUT, V. M. ILORKAR AND AARTI DESHMUKH	240

148	WOODY SPECIES DIVERSITY, STRUCTURE AND REGENERATION STATUS OF SETEMA NATURAL FOREST, SETEMA DISTRICT, WESTERN ETHIOPIA BEKELE TULU BAYESSA	241
149	ASSESSMENT OF HISTORICAL SPATIO-TEMPORAL VARIABILITY IN RAINFALL AND DROUGHT OF KALYAN-KARNATAKA REGION, KARNATAKA, INDIA J. B. KAMBALE¹ AND D. BASAVARAJA²	241
150	CHARACTERIZATION OF WILD POMEGRANATE AN: OVERVIEW SAFINA KOSSER*¹ AND DEEP JI BHAT¹	242
151	EFFECT OF C/N RATIO LEVELS AND STOCKING DENSITY OF CATLA SPAWN (<i>Gibelion catla</i>) ON WATER QUALITY, GROWTH PERFORMANCE AND BIOFLOC NUTRITIONAL COMPOSITION IN INDOOR BIOFLOC SYSTEM SONIA SOLANKI*, S. J. MESHAM, H. B. DHAMAGAYE, S. D. NAIK, P.E. SHINGARE, B. M. YADAV	243
152	BEE ATTRACTANTS FOR ENHANCING FRUITING BEHAVIOUR IN KIWIFRUIT N C SHARMA, LANDI JAILYANG, PRIYANKA CHAUHAN* AND TANZIN LADON	243
153	AGROFORESTRY AS A STRATEGY FOR CARBON SEQUESTRATION AND CARBON TRADING MANJOT SINGH SIDHU AND K. K. SOOD	244
154	SCENT-MARKING OF AFRICAN CIVET (<i>Civettictis civetta</i>, Schreber, 1776) IN ARIDTSY FOREST, WESTERN ETHIOPIA. DESSALEW SHITU AYENE AND BEKELE TULU BAYISSA	245
155	QUANTITATIVE ANALYSIS OF ESSENTIAL INGREDIENTS, NUTRACEUTICAL, AND TRACE ELEMENTS IN HERBAL INFUSION C. S. SANWAL¹, *A.K. BHANDARI¹, RAKESH BISHT¹, NARAYAN SINGH², M. BAUNTHIYAL³	245
156	EVALUATION OF THE ROLE OF MICRO AND MACRO ENVIRONMENTAL FEATURES ON THE ADAPTABILITY OF SAFFLOWER IN A GENOMIC CROP IMPROVEMENT PROGRAM MEGHA SHARMA^{1*}, ARUN JAGANNATH¹, SHAILENDRA GOEL¹, ANI A. ELIAS²	246
157	IPR AND UTILIZATION OF PLANT RESOURCES NUSRAT UL ISLAM¹, SUMMIRA RAFIQ², GOWHAR ALI³, Z. A. DAR³, M. A. RATHER¹, ALTAF WANI¹, P. A. SOFI¹	247
158	HIGH-THROUGHPUT PHENOTYPING FOR DEVELOPING CLIMATE CHANGE RESILIENT CROPS NUSRAT UL ISLAM¹, SUMMIRA RAFIQ², GOWHAR ALI³, Z. A. DAR³, M. A. RATHER¹, ALTAF WANI¹, P. A. SOFI¹	248
159	PRECISION AGRICULTURE: A NOVEL CROP MANAGEMENT STRATEGY NUSRAT UL ISLAM¹, SUMMIRA RAFIQ², GOWHAR ALI³, Z. A. DAR³, M. A. RATHER¹, ALTAF WANI¹, P. A. SOFI¹	248

160	PERFORMANCE OF FIELD PEA (<i>Pisum sativum</i>) AS UTERA CROP IN RELATION TO GROWTH DURATION OF RICE (<i>Oryza sativa</i>) UNDER RAINFED CONDITION R.K. DWIVEDI*, M.K. AHIRWAR* AND R. JHARIYA*, R. KHAVSE*, A. BADGAIYA* AND AVDHESH PATEL**	249
161	IMPACT OF CLIMATE CHANGE ON INSECT PESTS, DISEASES AND THEIR MANAGEMENT SUMMIRA RAFIQ ¹ , SHAFIYA RASHID ² , M. A. MANTOO ¹ , T. H. ASKARY ¹ , NUSRAT UL ISLAM ³	250
162	HORTICULTURE- A PARADIGM SHIFT IN FOOD PRODUCTION AND SECURITY R H DAHIYA	251
163	NANOBIOTECHNOLOGY APPLICATIONS IN FOOD SECTOR AND FUTURE INNOVATIONS NIVAS MANOHAR DESAI	254
164	TEMPERATURE SUITABILITY AND CO-OCCURANCE UNDER CLIMATE CHANGE FOR THE FALL ARMYWORM, <i>Spodoptera frugiperda</i> (Lepidoptera: Noctuidae). SHAFIYA RASHID ^{1*} , R. K. GUPTA ¹ , SUMMIRA RAFIQ ²	256
165	ENHANCEMENT OF PLANT PRODUCTIVITY BY INTEGRATED NUTRIENT MANAGEMENT In <i>Melia composita</i> : AN OVERVIEW QURAT UL AIN BINTE SYED ^{1*} , K.K. SOOD ¹	256
166	EFFICIENCY OF POST EMERGENCE HERBICIDE FOR ENHANCING YIELD ATTRIBUTES, YIELD AND ECONOMICS OF HYBRID MAIZE (<i>Zea mays</i> L.) NOOR MOHAMMAD KAKAR ¹ , SAYED YUONUS AMINI ² , MOHIBULLAH SAMIM ³	257
167	WOMEN AND ENVIRONMENTAL GOVERNANCE IN HIMALAYAS: A CASE STUDY OF UPPER KULLU VALLEY MONICA AHLAWAT	258
168	STUDIES ON PEACH BUDDING IN STOOL BEDS OF 'RUBIRA' ROOTSTOCK PREETIKA VERMA ^{1*} , NAVEEN C SHARMA ¹ , PRAMOD VERMA AND UDAY SHARMA	259
169	INSECT BIODIVERSITY IN AN AGRICULTURAL ECOSYSTEM OF TARAI REGION OF RAMNAGAR, UTTARAKHAND REKHA*, DEEPIKA GOSWAMI, DEEKSHA ARYA AND B. R. KAUSHAL	260
170	APPLICATION OF REMOTE SENSING AND GEOGRAPHICAL INFORMATION SYSTEM IN AGRICULTURE AND NATURAL RESOURCES MANAGEMENT SUMMIRA RAFIQ ¹ , NUSRAT UL ISLAM ² , SHAFIYA RASHID ³ , QURAT-UL-AIN BINTE SYED ⁴ , AMREENA AKHTER ⁵	260
171	ONE CARRIER SPACE-CHARGE-LIMITED CURRENT FLOW IN INSULATOR R. JHARIYA, M.K. AHIRWAR, R.K. DWIVEDI AND R. KHAVSE	261

172	BIOFORMULATION OF ENTOMOPATHOGENIC FUNGUS Against <i>Helopeltis theivora</i> WATERHOUSE (HEMIPTERA: MIRIDAE)” PRIYA KAUR AND PURNIMA DAS	262
173	SELECTION OF <i>Melia composita</i> Willd. PLUS, TREES FOR GENETIC DIVERSITY ANALYSIS IN ARUNACHAL PRADESH, INDIA UNSHANI DARYAL ^{1*} , SHIVANI DOBHAL ¹	262
174	SEX DETERMINATION METHODS IN FARM ANIMALS SANJEEV RANJAN	263
175	MORPHOLOGICAL CHARACTERIZATION OF PALMAROSA (<i>Cymbopogon martinii</i>) FOR ESSENTIAL OIL CONCENTRATION PAWAN KUMAR ^{1*} , AJAY KUMAR ¹ , RAHUL DEV GAUTAM ¹ , RAVI KUMAR ¹ , SANATSUJAT SINGH ¹ , AND ASHOK KUMAR ^{1*}	266
176	CONSEQUENCES OF COVID-19 ON THE ENVIRONMENT & SOCIETY DROUPTI YADAV ¹ , ARTI YADAV ²	267
177	COLLECTION AND PROFILING OF MAIZE GENETIC RESOURCES TO REDESIGN MAIZE AS A NUTRICEREAL SURINDER SANDHU*, YOGESH VIKAL, GAGANDEEP SINGH, TOSH GARG, WAJHAT UN NISA AND HARJOT KAUR	268
178	FORECASTING OF AREA, PRODUCTION, AND PRODUCTIVITY OF SUGARCANE IN INDIA LOKESH KUMAR AND *PRADEEP MISHRA	269
179	MORPHOMETRIC STUDY OF <i>Oscheius</i> genera OF KARANPRAGYAG REGION CHAMOLI UTTARAKHAND, INDIA. SHIKHA THAPLIYAL* NISHA RANA	269
180	ROLE OF NANOPARTICLES IN WATER PURIFICATION AND RECLAMATION AKANSHA BASSI*, NISHA RANA	270
181	THE MAGNIFICENT ROLE OF METAL, METAL OXIDES AND PLANTS BASED NANOMATERIALS IN BIOREMEDIATION OF POLLUTANTS SUGANDHA MISHRA ¹ , DHIRENDRA KUMAR ^{2*} , RAJESH KUMAR SHARMA ³ , ASHA SHARMA ⁴ , AMIT KUMAR DUTTA ⁵	270
182	SOIL HEALTH AND CARBON DYNAMICS AS INFLUENCED BY BIOCHAR APPLICATION IN MAIZE GROWN INCEPTISOLS OF KASHMIR OWAIS ALI WANI, FARIDA AKHTER, SHAKEEL A MIR, RAIHANA H KANTH, Z A BABA, F A PIR, S R DAR	271
183	PROTECTIVE ROLE OF <i>Spirulina</i> platensis AGAINST CADMIUM SULPHATE TOXICITY IN THE HISTOPATHOLOGY OF GILLS IN <i>Clarias batrachus</i> PRAGATI ¹ AND DR. GARIMA PUNDIR ²	272
184	BETA-GLUCAN FROM EDIBLE MUSHROOMS AS FUNCTIONAL BIOMATERIAL SUHANI SAJAD* AND JAGMOHAN SINGH	273
185	EFFECT OF RICE HUSK ASH ON CONTROLLING STORAGE INSECT PESTS OF PIGEON PEA	274

	M.S. SINGH, TABULIU ABONMAI AND KSH. MANISHWARI DEVI	
186	A COMPARATIVE STUDY ON PROTEIN, IRON AND ZINC CONTENT ON CERTAIN RED RICE CULTIVARS OF MANIPUR TABULIU ABONMAI, M.S SINGH AND KSH. MANISHWARI DEVI	274
187	EFFECT OF SEASONING D ON SOME SERUM KIDNEY FUNCTION PARAMETERS ABDULMUTALIB A., A.Y ABBAS, SALAUDEEN A.A. AND ABDULJALAL A	274
188	NUTRITIONAL STATUS OF DRAGON FRUIT BHAVANA DHAKER*, RAJA RAM BUNKER	275
189	MECHANISMS OF POLLINATION AND BREEDING OBJECTIVE OF GLADIOLUS MANISHA VERMA AND RAJA RAM BUNKER	275
190	SEASONAL INCIDENCE OF GRIDLE BEETLE (Obereopsis brevis) IN SOYBEAN [Glycine max (L.) Merrill] DEVESH PARMAR, J. KAVIPRIYA	276
191	ORGANIC FARMING - A NEED FOR HEALTHY ECOSYSTEM PRATIBHA AND MANISHA VERMA	277
192	INTRODUCTION OF GMELINA ARBOREA BASED AGROFORESTRY IN EASTERN UTTAR PRADESH (INDIA) ANUBHA SRIVASTAV & RAMBIR SINGH	277
193	EFFECTS OF MALARIA PARASITE ON COMPLETE BLOOD COUNT SWATI, SANCHITA PAL, AANCHAL	278
194	FACTORS ASSOCIATED WITH ANEMIA AVDHESH KAMBOJ, SANCHITA PAL, AESHA KAMBOJ	278
195	BRUCellosis: AN OVERVIEW AANCHAL SANCHITA PAL	279
196	NATIONAL EDUCATION POLICY 1986 & NATIONAL EDUCATION POLICY 2020: AN INSIGHT THROUGH COMPARATIVE ANALYSIS SUDHANAND PRASAD LALI AND MALLELA BANDHAVYA	280
197	CLIMATE-SMART AGRICULTURE WITH AN EMPHASIS ON MITIGATING THE IMPACTS OF CLIMATE CHANGE ON AGRICULTURE AND FOOD SECURITY. OSMAN ALI, DEBLINA ROY, SUCHANDRA NEOGI	281
198	EVALUATION OF VARIABILITY IN SOIL PROPERTIES INFLUENCING PIGEONPEA (Cajanus cajan L.) YIELD: A MULTIVARIATE STATISTICAL APPROACH VIJAYA B. WALI, RAJESH N.L.	282
199	ORGANIC FARMING - A NEED FOR HEALTHY ECOSYSTEM PRATIBHA AND MANISHA VERMA	282
200	EFFECT OF FEEDING HYDROPONIC HORSEGRAM SPROUTS ON GROWTH PERFORMANCE OF KONKAN KANYAL GOATS DIVYA KOKANI, B. G. DESAI, D. J. BHAGAT, V. S. DANDEKAR, J. S. DHEKALE	283
201	SOCIO-ECONOMIC PROFILE OF STAKEHOLDERS OF NATIONAL AGRICULTURE MARKET (e-NAM)	283

	MALLELA BANDHAVYA¹, ASHOK KUMAR SINGH, SUDHANAND PRASAD LAL AND GYAN SHUKLA	
202	USE OF MULTILINE AND MIXED CULTIVAR FOR PESTS MANAGEMENT IN HILL FARMING SYSTEM B. TUDU, B. PATRA, B. R. SHARMA, H. K. TARAFDER S. BASKEY, S. GURUNG, S. ALI AND T. S. GHIMIRAY	284
203	ROLE OF MELATONIN IN GASTRO INTESTINAL TRACT ARVIND KUMAR PATHAK, SANCHITA PAL, VINAY YADAV	285
204	A REVIEW OF METHICILLIN RESISTANT <i>Staphylococcus Aureus</i> AESHA KAMBOJ, SANCHITA PAL, AVDHESH KAMBOJ	285
205	ASSESSMENT OF GROUNDWATER QUALITY USING WATER QUALITY AND HEALTH RISK INDEX IN NCR REGION OF UTTAR PRADESH, INDIA FAHEEM AHAMAD* MUKESH RUHELA AND SWETA BHARDWAJ	286
206	COSTS AND BENEFITS OF TWO OIL PALM PLANTATIONS LOCATED IN UGANDA AND MALAYSIA BONNY KAYONDO, MOHAMADU BOYIE JALLOH, IIMAS ABDUROFI, NUR AAINAA BINTI HASBULLAH, PARAMANANTHAN SELLIAH	286
207	WATERSHED PRIORITIZATION OF KAILALI DISTRICT THROUGH MORPHOMETRIC PARAMETERS AND LANDUSE/LANDCOVER DATASETS USING GIS SUSIL OJHA, LILA PURI, ARJUN PRASAD BASTOLA	287
208	EFFECT OF DIFFERENT LAND USE SYSTEMS ON SOIL QUALITY UNDER SUBTROPICAL REGION OF JAMMU. D.MAMTA, K.R. SHARMA	287
209	ROLE OF SUCROSE AND ITS METABOLISM IN SEED DEVELOPMENT APARNA JYOTI, AMRITA KUMARI	288
210	ANALYSING FOREST MANAGEMENT PRACTICE THROUGH REGENERATION STATUS AND GROWTH PATTERN IN DIFFERENT FELLING SERIES: A CASE STUDY FROM COMMUNITY FOREST OF RUPANDEHI DISTRICT, NEPAL BISHWABANDHU ACHARYA, BIKASH ADHIKARI, ARJUN PRASAD BASTOLA, YAJNAMURTI KHANAL	289
211	CYANOBACTERIA AS A BIOREACTOR FOR THE AGNPS SYNTHESIS AND THEIR APPLICATIONS SHAHEEN HUSAIN	290
212	INTRODUCTION OF <i>HEENG (Ferula assa-foetida)</i> PLANT TO COLD DESERTS OF INDIAN HIMALAYAS ASHOK KUMAR^{1*}, SANATSUJAT SINGH¹, SATBEER SINGH¹, RAMESH CHAUHAN¹, AND SANJAY KUMAR²	290
213	ASSESSMENT OF IMPACT OF POVERTY ON CHURE DEPLETION BIPIN YADAV, DHRUVA BIJAY GC AND JIT NARAYAN SHAH	291
	RESOURCE ASSESSMENT AND MARKETING OF CATERPILLAR FUNGUS (<i>OPHIOCORDYCEPS SINENSIS</i>) IN THE BUFFER ZONE OF MAKALU BARUN NATIONAL PARK, NEPAL	292

	DAMODAR GAIRE[*], KAMAL KAFLE, JIT NARAYAN SAH	
214	HABITAT AND ANTHROPOGENIC FACTORS INFLUENCING GHARIAL (<i>Gavialis gangeticus</i>) DISTRIBUTION AND HABITAT USE IN NARAYANI RIVER OF CHITWAN NATIONAL PARK, NEPAL CHITRA REKHA BASYAL, BIJAYA NEUPANE, JIT NARAYAN SHAH	292
215	INNOVATION OF SPOT APPLICATOR IN PINEAPPLE CROP FOR UNIFORM HARVESTING RAJEEV P. NADIG[*], ARUNKUMAR P.^{**}, SHASHIDHAR K. C.^{**}, DR. PREMASUDHA B G.^{***}	293
216	MASS CLONAL PROPAGATION OF <i>MUCUNA PRURIENS</i> (FABACEAE) AND ASSESSMENT OF ITS PHYTOCHEMICAL PROPERTIES. NEHA SAINI, NAVEEN GAURAV	294
217	NUTRITIONAL ASSESSMENT OF FRESH AND FERMENTED BAMBOO SHOOTS LOCALLY CONSUMED IN SIKKIM L. BASANTARANI & Y. RANJANA DEVI	295
218	SEED PRODUCTION IN ANNUAL FLOWER CROPS RAHAT ASHRAF AND MEHJABEEN	295
219	SUSTAINABLE UTILISATION OF NATURAL RESOURCES: PROBLEMS AND SOLUTION MADHU SHARAN	296
220	EFFECT OF IRRIGATION AND FERTIGATION LEVELS MULCH ON GROWTH, YIELD AND QUALITY OF CAPSICUM (<i>Capsicum annum</i> L.) UNDER POLY HOUSE SUNIL KUMAR YADAV[*], RAJA RAM BUNKER	296
221	EFFECT OF GIBBERELIC ACID IN CUCUMBER KAMLESH KUMAR YADAV¹, SUNIL KUMAR YADAV¹ AND GANPAT LAL YADAV¹	297
222	EFFECT OF DIFFERENT DRYING CONDITION ON THE COLOR AND REHYDRATION CHARACTERISTIC OF ASPARAGUS (<i>Asparagus Racemosus</i> L.) ROOTS DEEPIKA KOHLI	297
223	PRINCIPAL COMPONENT ANALYSIS IS AN EFFICIENT TOOL FOR HIGHLIGHTING THE RELATIONSHIPS WITH IN YIELD AND YIELD ATTRIBUTES OF GREENGRAM [<i>Vigna radiata</i> (L.) Wilczek] SHAILENDRA SAGAR PRAJAPATI¹, SANJAY KUMAR SINGH¹, PRATIK KUMAR¹, PARIKHA PRAKASH SINGH², KARISHMA BEHERA¹ AND KRISHNAKANT VISHWAKARMA³	298
224	COMPARATIVE STUDY OF CARBON STOCK IN COMMUNITY FORESTS OF CHURE AND MAHABHARAT RANGE IN SINDHULI DISTRICT, NEPAL	299
225	PHYSIOLOGICAL APPROACHES FOR YIELD MAXIMIZATION IN RICE (<i>Oryza sativa</i> L.) YASMEEN BEGUM¹, R. P. PATIL² AND K.MAHANTHASHIVAYOGAYYA³	299
256	IMPACT OF CLIMATE CHANGE ON FISHERIES AND AQUACULTURE IN NEPAL	300

	DILIP KUMAR JHA	
257	A STUDY ON AGRICULTURE PRODUCTION IN INDIA V. GANGADEVI AND A. SARAVANADURAI	302
258	ESTIMATION OF MAIZE-SOYBEAN INTERCROPPING ON RUNOFF, SOIL AND NUTRIENT LOSS, AND CROP GROWTH UNDER FIELD CONDITION AT DIFFERENT SLOPES FOR SHIVALIK FOOTHILLS IN HIMALAYAS RAM KUMAR, P. V. SINGH AND GURVINDER SINGH	302
259	ESTIMATION OF VARIABILITY PARAMETERS FOR SEED YIELD AND YIELD CONTRIBUTING TRAITS IN INDIAN MUSTARD (<i>Brassica juncea</i> L) SABYASACHI SAHU, S.K. TEWARI, USHA PANT, B. SUDHAKAR REDDY	303
260	IMPACT OF DISASTERS IN HUMAN, ANIMAL AND ENVIRONMENT NIVEDITA KHIRIYA AND SANDEEP KUMAR	303
261	ROLE OF <i>Trichoderma</i> SPECIES AND THEIR SECONDARY METABOLITES IN THE IMPROVEMENT OF CHILLI HEALTH AND YIELD NASREEN MUSHEER* AND ANAM CHOUDHARY	303
262	EFFECT OF INORGANIC FERTILIZER, ORGANIC MANURES AND NANO UREA ON GROWTH PARAMETERS OF GARLIC (<i>Allium sativum</i> L.) RAJESH CHOUDHARY, M R CHOUDHARY, MURARI LAL CHOPRA, ASHOK CHOUDHARY, ANITA CHOUDHARY KIRAN CHOUDHARY AND SUNIL KUMAR YADAV	304
263	BIODIVERSITY OF NORTH-EAST INDIA AND SEED AS MAJOR ENIGMA FOR CONSERVATION NAFLATH, T. V., RAJENDRA PRASAD, S. AND NAGARAJU, K. S	305
264	ECO FRIENDLY SOLUTION TO COMBAT NUTRITION DEFICIENCY USING MICROGREENS AND NANO TECHNOLOGY (F SHEET) JEEVA.M , AJAY PATTABIRAMAN and PAVITHRA VERTHIKERE RAVI	305
265	EFFECT OF MACRO AND MICRONUTRIENT ON GROWTH PARAMETERS OF LEMON (<i>Citrus limon</i> L.) MURARI LAL CHOPRA*, K K MEENA, RAJESH CHOUDHARY, KAMAL MAHALA AND SUNIL KUMAR YADAV	306
266	THE EFFECT OF NITROGEN ON GROWTH, YIELD AND QUALITY OF BEETROOT ANITA CHOUDHARY* AND RAJESH CHOUDHARY	307
267	<i>Mesorhizobium</i> IMPROVES CHICKPEA GROWTH UNDER CHROMIUM STRESS AND ALLEVIATES CHROMIUM CONTAMINATION OF SOIL HUMA NAZ¹,* RIYAZ Z. SAYYED², RIYAJ UDDIN KHAN³ ASMA NAZ⁴, OWAIS ALI WANI⁵, AYESHA⁶ AND SAMIYA⁷, ALI FAHAD⁸, SHABBIR ASHRAF¹	307
268	EFFECT OF INSECTICIDES ON THE MANAGEMENT OF <i>Scitthrips dorsalis</i> ON CHILLI CROP	308

	SURENDRA SINGH SHEKHAWAT* AND M. SHAFIQ ANSARI	
269	BIOLOGY OF FALL ARMYWORM, <i>Spodoptera frugiperda</i> (NOCTUIDAE: LEPIDOPTERA) ON DIFFERENT CEREAL HOST PLANT PHOOL SUMERA AND PARVEZ QAMAR RIZVI	308
270	NEW RECORD OF SIX-SPOT GROUND BEETLE <i>Anthia sexguttata</i> (Fabricius, 1775) (Coleoptera: Carabidae), A BIOLOGICAL PEST CONTROLLER, FROM JEHANABAD, BIHAR (INDIA) AKHLAQ HUSAIN¹ AND WAJID HASAN²	309
271	ESTIMATION OF G X E INTERACTION BY AMMI MODEL IN SOME ELITE CHICKPEA (<i>Cicer arietinum</i> L.) Genotypes ARVIND CHAUHAN *, ANJU ARORA, R.K.PANWAR, S.K.VERMA, SHREYA, NIMITA KANDWAL AND ANUPRIYA RANA.	309
272	INTEGRATED NUTRIENT, WEED, DISEASE AND PEST MANAGEMENT AKANSHA VERMA *, JHABAR MAL TETARWAL¹	310
273	HI TECH HORTICULTURE FARMING USHERED IN A NEW ERA POOJA KUMARI	310
274	MICRONUTRIENTS IN FOOD PRODUCTION: WHAT CAN WE LEARN FROM NATURAL ECOSYSTEMS PRAKASH CHAND GURJAR	311
275	EFFECT OF INORGANIC AND ORGANIC SOURCES OF FERTILIZATION ON NUTRIENT CONTENT, UPTAKE, AND QUALITY OF FENUGREEK (<i>Trigonella foenum-graecum</i> L.) UNDER AGRO-CLIMATIC CONDITIONS OF RAJASTHAN MANOJ	311
276	STUDY OF THE IMPACT OF UNEMPLOYMENT ON YOUTH'S MENTAL AND PHYSICAL HEALTH AND HEALTH RISK BEHAVIOR PRATIKSHA AND SEEMA RANI	312
277	ADVANCEMENTS AND FUTURE PROSPECTIVE OF DNA BARCODES IN ANTICANCER ACTIVITY OF MEDICINAL PLANTS SAPTARSHI BISWAS, SHRIKANT SHARMA	314
278	INSECTS AS BIOINDICATORS OF ENVIRONMENTAL CHANGES DEEPENDRA KUMAR SAINI	314
279	CLIMATE CHANGE AND ABIOTIC STRESS MANAGEMENT” SONAL ATHNERE	315
280	DEVELOPING CLIMATE CHANGE RESILIENT CROP DEVENDRA KUMAR VERMA	315
281	IMPACTS OF CLIMATE CHANGE ON INDIAN AGRICULTURE JITENDRA SUMAN AND P. S. SHEKHAWAT	316
282	EFFECTIVE VALUE CHAIN MANAGEMENT TO IMPROVE LIVELIHOOD SECURITY OF MILK PRODUCERS LAKSHEETA CHAUHAN*, RAMESH CHAND BUNKAR	316
283	WORLDWIDE EDUCATION POLICIES AND NATIONAL EDUCATION POLICY 2020 RAMESH CHAND BUNKAR^{1*}, LAKSHEETA CHAUHAN²	317

284	ORGANIC HORTICULTURE: A HEALTHY APPROACH IN THE MODERN WORLD RAM LAKHAN MEENA AND RAJA RAM BUNKER	317
285	IN VITRO SHOOT PROLIFERATION FROM DIFFERENT EXPLANTS IN POMEGRANATE (<i>Punica granatum L.</i>) REKHA CHOUDHARY*, M.L.JAKHAR AND SUSHILA CHOUDHARY	318
286	BROAD STRATEGY FOR IMPROVING FARMERS' INCOME AKASH TANWAR	319
287	INFLUENCE OF DIFFERENT TRANSPLANTING DATES AND SHOCK PREVENTING METHODS ON YIELD AND ECONOMICS OF PEARL MILLET (<i>PennisetumtyphoidesL.</i>) VARIETIES VIJAY LAXMI YADAV AND RANI SAXENA	319
288	IMPACT OF PHYSIOLOGICAL PARAMETERS ON GROWTH AND SPORULATION OF <i>Fusarium oxysporumf. sp. Lycopersici</i> CAUSING TOMATO FUSARIUM WILT SUSHILA CHOUDHARY*, R.K. BAGRI AND REKHA CHOUDHARY	320
289	SEMIOCHEMICALS IN PEST MANAGEMENT UDAI PAL SINGH	320
290	PRODUCTION OF F₁ HYBRIDS OF PEARL MILLET USING LINE X TESTER METHOD KOMAL SHEKHAWAT, P. C. GUPTA	321
291	EFFICACY OF FUNGICIDES PLANT EXTRACTS AND BIO-AGENTS ON MANAGEMENT OF ANTHRACNOSE OF CHILLI THROUGH SEED TREATMENTS CHANDRA SINGH CHOUDHARY	321
292	ROLE OF POST-HARVEST TECHNOLOGY IN HORTICULTURAL CROPS DUSHYANT PARIHAR ¹ AND CHANDER SINGH CHOUDHARY ²	322
293	AN ECONOMIC ANALYSIS OF MARKETING OF PAPAYA IN JAIPUR CITY OF RAJASTHAN SUMAN CHAUDHARY, OM PRAKASH	322
294	GENETIC DIVERGENCE ANALYSIS IN TARAMIRA (<i>Eruca sativa Mill.</i>) UNDER DIFFERENT ENVIRONMENT CONDITIONS WITH SPECIAL REFERENCE TO PRINCIPAL COMPONENT ANALYSIS MAHAVEER PRASAD OLA AND M. L JAKHAR	323
295	CLIMATE CHANGE MANAGEMENT IN RURAL LIVELIHOOD OF INDIA GYAN PRAKASH MORYA	323
296	EFFECT OF ROCK PHOSPHATE, POULTRY MANURE AND PHOSPHATE SOLUBILIZING BACTERIA ON YIELD OF CHICKPEA DESHRAJ MEENA, R.H. MEENA, AJIT KUMAR MEENA, KRITI SHARMA	324
297	VEGETABLE GARDEN FOR SEED PRODUCTION GAJENDRA CHAWLA, KULDEEP HARIYANA	324
298	THE ROLE OF LIVESTOCK IN INDIA'S ECONOMIC DEVELOPMENT KESHARAM MEENA AND BHAVYA PAL	325

299	KITCHEN GARDEN OR NUTRITION GARDEN KULDEEP HARIYANA, GAJENDRA CHAWLA	325
300	CHANGES IN LAND USE PATTERN AND AGRI-HORTI PRODUCTION OF FARMERS THROUGH THE TRANSFERRED TECHNOLOGIES UNDER VILLAGE ADOPTION PROGRAMME OF MPUAT, UDAIPUR NITESH KUMAR TANWAR, RAJEEV BAIRATHI, S. S. SISODIA	326
301	ROLE OF PLANT ROOT METABOLITES AS NEMATODE ATTRACTANTS, REPELLENTS AND HATCHING STIMULANTS BASANT DESHWAL	326
302	ASSESSING THE EFFICACY OF INSECTICIDAL SPRAY SCHEDULES FOR WHITEFLY CONTROL ON CHILLI (<i>Capsicum annum</i> L.) LAXMAN SINGH SAINI AND MANGAL SUKHI MEENA	327
303	SEASONAL INCIDENCE OF BIHAR HAIRY CATERPILLAR (<i>SPILOSOMA OBLIQUA</i> WALKER) INFESTING SOYBEAN VARIETY JS 97-52 MANGAL SUKHI MEENA, LAXMAN SINGH SAINI	327
304	DTPA – EXTRACTABLE MICRONUTRIENTS STATUS OF THE SOILS UNDER PADDY - POTATO CROPPING SYSTEM OF MEERUT DISTRICT OF UTTAR PRADESH, INDIA SHIVAM SINGH ¹ , SATENDRA KUMAR ¹ , B. P. DHYANI ¹ AND U. P. SHAH ¹	328
305	PROMISING ARRANGED IMPACTS OF ASHWAGANDHA ON BROILER EXECUTION AND CARCASS CHARACTERISTICS: A COMPREHENSIVE REVIEW BHAVYA PAL AND KESHARAM MEENA	328
306	EFFECT OF WEED MANAGEMENT ON NUTRIENT CONTENT AND UPTAKE OF LENTIL (<i>Lens culinaris</i> Medik. L.). SATYA NARAYAN GURJAR	329
307	SUITABILITY AND GROWTH PERFORMANCE OF <i>Labeo calbasu</i> (Hamilton, 1822) IN CARP POLYCULTURE SYSTEM AT MID HILL AREAS OF ARUNACHAL PRADESH, N.E.R INDIA V.K. MISRA	329
308	ICT APPLICATIONS IN AGRICULTURE MARKETING VIKASH KUMAR MEENA	330
309	EFFECT OF CONSERVATION TILLAGE AND <i>IN-SITU</i> GREEN MANURING ON SOIL MICROBIAL POPULATION DEVAPPA ¹ , RAJASHEKARAPPA, K. S ¹ , DEVARAJ, K ² , LATHA, H. S ²	330

A MODEL FOR IRRADIANCE RESPONSE ON PHOTOSYNTHETIC APPARATUS IN MANGO (*Mangifera indica*) LEAVES

RAMWANT GUPTA^{1,2} AND CHHEDI LAL VERMA³

¹The University of Guyana, Georgetown, Guyana, South America

²Fiji National University, Natabua Campus, Fiji Islands

³Central Soil Salinity Research Institute, Regional Research Station (CSSRI-RRS), Lucknow, UP, India

ABSTRACT

The development of a mathematical model describes the photosynthetic electron transport (PET) changes in both juvenile red and mature green mango leaves exposed to sunlight at different photosynthetic active radiation (PAR). This dynamic mathematical model covers the entire photosynthetic apparatus including the photo-systems I (PSI) and II (PSII), the electron carriers between the two photo-systems, the final electron acceptor complex the ferredoxin. The proposed mathematical model explained the variations of F_v/F_m , $\psi(E_o)$, $\phi(E_o)$, $\delta(R_o)$, PI_{abs} , and PI_{total} to PAR perfectly with $r=1$ and $S=0$ for red as well as green leaves. The integration of associated PET response shown segmental area follows a similar trend as that of associated physiological response curve while cumulative associated physiological response and cumulative percent of associated physiological responses have a similar S-shape trend. Since the correlation coefficients for the parameters is unity meaning thereby is perfect validity of the hypothesis and the developed model. The developed model could be useful for studying accumulated associated physiological responses against varying radiations. Percent radiation retardation or microclimatic management such as temperature and humidity control could better understand the trees or crops.

Keywords: Red leaf, mango, mathematical model, PAR, photosynthetic electron transport

VERMITECHNOLOGY–AN EXCELLENT TOOL FOR ORGANIC AGRICULTURE

ABDULLAH ADIL ANSARI

Department of Biology, University of Guyana, Georgetown, Guyana

ABSTRACT

Organic farming is an important concept towards sustainable development that involves the use of organic input for the production of crops. Biofertilizers like vermicompost and vermiwash increase the organic matter content necessary for the maintenance of soil properties, which is beneficial for long-term sustainability and crop productivity. Biofertilizers are enriched with micronutrients and beneficial microbes that enhance the soil quality and aid in slow release of nutrients required for the healthy growth of plants. Various small- and large-scale experiments on field crops like wheat, sugarcane, paddy along with vegetables like tomato, okra and eggplant have been successful in terms of productivity and quality of produce. These technologies have also been adopted successfully by food growers across the globe resulting in substantial markets for organic produce.

Keywords: Biofertilizer; vermicompost; vermiwash; soil improvement, crop productivity.

Introduction

Excessive use of chemical fertilizers and pesticides in agricultural lands over long period of time has resulted in poor soil health with combined effect on crop production and increase incidences of pests and diseases. These concerns have led to greater economic impact on farmers. Over the last few years the problems associated with food security has led to thinking

in terms of organic agriculture by soil management techniques and microbial innovations. Soil microbiology influences above ground ecosystem by contributing to plant nutrition, health, soil structure and fertility. They also play a pivotal role in various biogeochemical cycles and cycling of organic compounds (Kirk *et al.*, 2004). Plant growth is improved when beneficial microbes increases nutrient availability and stimulates plant growth (Haynes and Krause, 2011). Biofertilizers, referred to the use of soil microorganisms to increase the availability and uptake of mineral nutrients for plant (Ansari, 2008), they are substance added to the soil to enhance the microorganisms, in order to increase the nutrient status. Vermicompost is one of the biofertilizersthat helps to promote humification, increased microbial activity and enzyme production, which subsequently helps to increase the aggregate stability of soil particles resulting in better aeration when applied to the soil. The material has excellent structure, porosity, aeration drainage and moisture holding capacity, and helps to improve the physical, chemical and biological properties of the soil (Ansari, 2008).

The biocomposting method is made up of two phases (breakdown and buildup phase). In the breakdown phase biodegradable wastes are decomposed into smaller particles. Proteins are broken down into amino acids and finally to ammonia, nitrates and free nitrogen. Similarly, urea, uric acids and other non-protein nitrogen-containing compounds are reduced to form different plant nutrients. In the build-up phase, there is the re-synthesis of simple compounds into complex humic substances. The organisms responsible for transformation to humus are aerobic and facultative aerobic, sporing and non-sporing and nitrogen fixing bacteria of the *Azotobacter* and *Nitrosomonas* group. *Actinomycetes* also play an important role. There are two major reasons why vermicomposting is better. Waste is converted faster. Conventional composting takes weeks to months to convert organic matter to compost and are very labor intensive. By using earthworms, waste is rapidly turned into vermicompost. The vermicompost is far superior to conventional compost. The worm castings in the vermicompost have nutrients that are highly utilizable by plants and the castings have a mucous coating which allows the nutrients to "time release". Vermicompost forms fine stable granular organic matter that assist in the aeration, released mucus that are hygroscopic absorbs water and prevents water logging and improves water holding capacity. Vermicompost added to the soil releases nutrient slowly and consistently and enables the plant to absorb these nutrients more readily. Soils enriched with vermicompost provide additional substances that are not found in the chemicals (Ansari and Ismail, 2001; Kale,1998). Biofertilizers contribute both macro and micro nutrients in amounts that are required by the plant and upon application have emphatic effect on plant growth parameters and production.

Organic waste possesses a serious environmental problem globally. This can be solved by Vermitechnology including Vermiwash and vermicompost, and also biodynamic preparation (500), which is essential component of biodynamic farming. Many researches over the years have been conducted, whereby solid waste were used and recycled to produce organic fertilizers using different technologies. In many developing countries there is a serious organic solid waste problem; preparing these organic fertilizers will be cost effective, and beneficial for farming (Ansari, 2009). The use of organic processes and materials in agriculture also helps to prevent environmental hazards, soil damage and nutrients loss due to the excess use of toxic chemical fertilizers and pesticides (Nath, *et al.*, 2009).

Role of earthworm in soil fertility and microbial management

Earthworms are key to maintaining soil fertility and nutrient cycling. Earthworms process organic nutrients for the efficient growth of plants. Earthworms also contribute to the physical and chemical changes in the soil, transforming in terms of soil fertility and affect plant growth. Earthworms release casts into the soil which is enriched with beneficial microorganisms. Earthworms are classified into three ecological types. Epigeics (*Eiseniafetida*, *Eudriluseugeniae*) are surface dwellers serving as efficient agents of comminuting and

fragmentation of leaf litter. They are phytophagous and generally have no effect on the soil structure as they cannot dig into the soil. Anecics (*Lampitoma*) feed on the leaf litter mixed with the soil of the upper layers and are said to be geophytophagous. They may also produce surface casts generally depending on the bulk density of the soil. Endogeic earthworms (*Octochaetona*) are geophagous and live within the soil deriving nutrition from the organically rich soil they ingest (Ismail, 2005).

Vermitechnology as Organic farming tool

Vermitechnology is a method of converting all the biodegradable wastes into useful product i.e., vermicompost, through the action of earthworms. Vermicompost is a sustainable bio-fertilizer regenerated from organic wastes using earthworm which contains 1.2 to 6.1% more nitrogen, 1.8 to 2.0% more phosphate and 0.5 to 0.75% more potassium compared to farm yard manure. It also contains hormones like auxins and cytokinins, enzymes, vitamins and useful microorganisms like bacteria, actinomycetes, protozoans, fungi etc (Ansari and Ismail, 2001). This process of decomposition results in the production of vermicompost. Vermicompost, or castings, is worm manure. It is considered by many in farming arena to be the very good soil improver. The nutrient content of castings is dependent on the material fed to the worms-and worms are commonly fed materials with high nutrient content (Ismail, 1997). It is the worm castings that provide these nutrients in a form that is readily available to plants. The biology of the worm’s gut facilitates the growth of fungus and bacteria that are beneficial to plant growth.

Process of Vermicomposting

Vermicomposting is a simple biotechnological process of composting, in which epigeic species of earthworms are used to enhance the process of waste conversion and produce a better end product. Vermicompost is a nutrient rich organic soil conditioner which can be applied to improve soil conditions for a wide range of soil types. The use of earthworms is very essential in this process, as the worms act for the composing of organic matter into a stable nontoxic material with good structure, which has a potentially high economic value and also act as soil conditioner for plant growth. Vermicomposting has many environmental benefits is proven to be an easy way of getting rid of garbage waste. This technique is also beneficial to the soil, and results in a lower use of synthetic fertilizers.

Vermicomposting units

Vermicomposting units can be set up on many ways. This system can be set up in a large box, a bucket, a bin, a basket and even in a pit in the soil. It is very important to keep in mind that a vermicomposting unit should be more than 1 meters in depth, but may be as long as preferred in width. It is also very important to note that such a unit is set up in the shade. Organic matter that is added to the unit should be dry to prevent an increase of temperature in the unit. The unit should be kept moist, therefore watering is very essential. The amount of materials which are layered during the building of the unit depends on the size of the unit which is set up.

The basic layering in a vermicomposting bin is as following:



Figure 1. Layering in the vermicomposting unit

The basal layer of the vermi-bed comprises of broken bricks followed by a layer of coarse sand (10 cm thick) in-order to ensure proper drainage. A layer (10 cm) of loamy soil should be placed at the top.100 locally collected earthworms were introduced into the soil. Fresh cattle dung is scattered over the soil and then it was covered with a 10 cm layer of dried grasses. Water issprinkledon the unitin-order to keep it moist. The dried grasses along with cattle dung is turned once a week. After 60 days, vermicompost units are regularized for the harvesting of vermicompost every 45 days. When the layering is completed, the unit should be covered with dried leaves and left for 60 days. During the period of these 60 days, organic material and cow dung should be added on a weekly basis, while watering every other day, depending on the moisture content of the material in the bin.

Harvesting of vermicompost

Vermicompost should be ready for harvesting in maximum 40-45 days. When the organic material in the unit is changed completely in structure and smells soil like, it is ready for harvest. The compost should be pressed in the hand to check on moisture content. Before harvesting, no water should be added to the unit for 3-4 days and a heap of the compost should be formed in the after harvesting. These actions will derive the earthworms in the deeper layers of the unit where the moisture content is slightly higher. The fourth day, the compost can be harvested and is ready to be used for agricultural purpose. This compost can be used directly in the soil and can be stored for 3 months if disposed well in a plastic bag.



Figure 2. Vermicompost at harvest

Benefits of vermicompost

- Vermicompost has many benefits on the soil, but has also many economic benefits which are:
- Source of Plant Nutrients to the Soil
- Improves its physical structure.
- Enriches soil with micro-organisms (adding enzymes such as phosphatase and cellulase)
- Microbial activity in worm castings is 10 to 20 times higher than in the soil and organic matter that the worm ingests.
- Attracts deep-burrowing earthworms already present in the soil
- Improves water holding capacity.
- Improving Crop Growth and Yield (Plant growth)
- Vermicompost plays a major role in improving growth and yield of different field crops, vegetables, flower and fruit crops.
- Enhances germination, plant growth, and crop yield
- Improves root growth and structure (rhizosphere)
- Enriches soil with micro-organisms (adding plant hormones such as auxins and gibberellic acid)
- Economic Benefits
- Biowastes conversion reduces waste flow to landfills

- Elimination of biowastes from the waste stream reduces contamination of other recyclables collected in a single bin (a common problem in communities practicing single-stream recycling).
- Boost to rural economy
- Less waste land formation
- Low capital investment and relatively simple technologies make vermicomposting practical for less-developed agricultural regions
- Eco-Friendly Environmental factors
- Good quality organic soil additives enhance the water holding capacity and nutrient supplying capacity of soil and also the development of resistance in plants to pests and diseases, thereby providing a sustainable environment in the soil
- Wastes create no pollution, as they become valuable raw materials for enhancing soil health
- Helps to close the "metabolic gap" through recycling waste on-site
- Reduction in greenhouse gas emissions such as methane and nitric oxide (produced in landfills or incinerators when not composted or through methane harvest)

Vermiwash production

Vermiwash is one of the materials produced by Vermicomposting which is an “Eco biotechnological process that transforms energy rich and complex organic substances in to a stabilized vermicomposts” primarily through the action of earthworms but with support of other micro-organisms. Vermiwash contains the soluble nutrients that were released in the vermicomposting process (Nath, *et al.*, 2009). Organic fertilizers such as Vermiwash provide a relatively cost effective and safe alternative to chemical fertilizers. According to Ansari and Sukhraj (2010), the use of chemical fertilizers, which is wide spread in many developing countries, can lead to soil damage and reduced soil health and production levels while increasing the incidence of pests and disease and environmental pollution. Vermiwash is a liquid that is obtained when water is left to flow slowly through a vermicomposting like unit. Vermiwash has fertilizing abilities and has also proven to have a pesticidal action when applied as a foliar spray. The layering of a vermiwash bin is the same as a vermicomposting unit, with the exception that this unit consists of a bucket to which a tap is attached at the lowest point to collect the vermiwash when ready. The organic matter that is added to this unit varies from ordinary grass clippings to plant material with pesticidal properties. The organic matter should be dried for 3 to 4 days to accelerate the composting action and regulate the temperature in the bin.

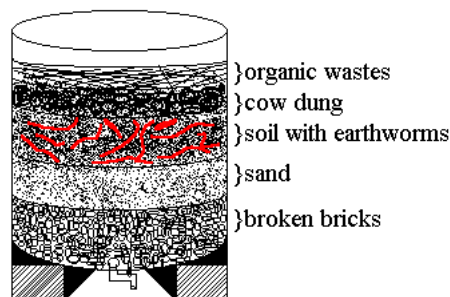

Figure 3. A detailed design of a vermiwash unit

The vermiwash unit is set up using buckets. A tap is fixed on the lower side of each bucket. The bucket is placed on a stand to facilitate collection of vermiwash. 5 cm of broken pebbles are placed at the bottom of the buckets followed by 5 cm layer of coarse sand. Water is then allowed to flow through these layers to enable the settling of the basic filter unit. A 15 cm layer of loamy soil is placed on top of the filter bed. Approximately 300 earthworms are introduced

into the soil. Dried grass and cattle dung are placed on top of the soil. The vermiwash unit is left to regularize after 60 days for collection of vermiwash every day. Approximately 0.5 litre can be collected on a daily basis. After layering the different material to the bin, the unit is left for 60 days to regulate with the tap open. Organic matter and cattle dung should be added on a weekly basis as needed. The unit should be watered every other day depending on the moisture content in the bin. Access water should be left to flow through the open tap. Vermiwash will be ready to collect when the liquid that is flowing through the tap gets pale yellow in color. When the color change is seen, the tap should be closed and water should be allowed to drip through the unit overnight. The following day the tap should be opened and the vermiwash should be collected in a plastic container. The color intensity of the vermiwash will differ according to the organic material that is added to the bin. After the first collection, vermiwash can be collected on a daily basis by repeating the same process of adding water to the unit. The vermiwash that is collected can be kept stored for 3 months in plastic containers. Vermiwash can be used by a dilution of 10% of the vermiwash with water and spray to the desired plant/crop.

Impact of Organic inputs in the Soil

Organic amendments like vermicompost promote humification, increased microbial activity and enzyme production, which, in turn, increase the aggregate stability of soil particles, resulting in better aeration (Tisdale and Oades, 1982; Dong *et al.*, 1983; Haynes and Swift, 1990; Perucci, 1990). Organic matter has a property of binding mineral particles like calcium, magnesium and potassium in the form of colloids of humus and clay, facilitating stable aggregates of soil particles for desired porosity to sustain plant growth (Haynes, 1986). Soil microbial biomass and enzyme activity are important indicators of soil improvement as a result of addition of organic matter (Perucci, 1990). Apart from these, earthworm castings are reported to contain plant growth promoters, such as auxins and cytokinins (Krishnamoorthy and Vajranabhaiah, 1986). Vermiwash, a liquid fertilizer produced by the action of earthworms, contains soluble plant nutrients, some organic acids, mucus and microbes, that has proved to be effective, both as a biological fertiliser (as a foliar spray) as well as a pesticide (Pramoth, 1995; Ismail, 1997; Kale, 1998).

The high content of organic matter in compost and the resultant effects of the organic matter on the humic fractions and nutrients in soil effectively increase the microbial population, activity and enzyme production, which in turn increases aggregate stability (Tisdale and Oades, 1982; Dong *et al.*, 1983; Haynes and Swift, 1990; Perucci, 1990). Humic acid and fulvic acid are important as persistent binding agents in mineral organic complexes and 52 to 92% of soil organic matter may be involved in these complexes (Edwards and Bremner, 1967; Hamblin, 1977). Increased plant litter incorporation, improved aggregation, better aeration and water relationships and the development of mull characteristics can be observed soils amended with organic inputs. These improvements in soil structure were confirmed by soil morphological studies as illustrated by Rogaar and Boswinkel, (1978). On the contrary there was reduction in organic carbon in plots treated with chemical fertilisers which may be due to negligible organic matter as input, moreover chemical inputs cause degradation of the soil structure resulting in unfavourable conditions for crop growth in an already difficult soil (Pagliaiet *al.*, 1983a, b; Shipitalo and Protz, 1988).

Vermicompost, one of the important types of compost, contains earthworm casts that are reported to be higher in available nitrogen (de Vleeschauwer and Lal, 1981; Satchell, 1983) which enhance the activity and number of microorganisms (Stewart and Chaney, 1975; Satchell and Martin, 1984; Satchell *et al.*, 1984). Increase in soil nitrogen through the application of vermicompost is likely to be due to stimulation of microbial activity specifically through increase in the colonization of nitrogen fixers and actinomycetes (Kale 1998; Borkenet *al.*, 2002). Much of the effect of application of compost on crop yield and productivity is derived

from the plant nutrients, particularly nitrogen in composts (Woodbury, 1992; Maynard, 1993; Ozores-Hampton *et al.*, 1994). Reports indicate that adequate quantities of phosphorus and potassium were supplied by compost application to the soil (Smith, 1992; Maynard, 1993; Ozores-Hampton, *et al.*, 1994). Vermicompost, is reported to contain desired quantity of phosphorus (de Vleeschauwer and Lal, 1981; Satchell, 1983) which enhances the activity and number of microorganisms producing acid-phosphatases in the soil (Stewart and Chaney, 1975; Satchell and Martin, 1984; Satchell *et al.*, 1984). Synergistically, these specific effects appear to raise phosphorus availability in soils amended with vermicompost (Buchanan and Gliessman, 1990).

Vermicompost application in the wheat-paddy cropping system has been reported to increase crop yield (Sharma and Mittra, 1991; Ismail, 1997). This is because nutrients present in vermicompost are readily available to the plants (Ismail, 1995; Rajkhowaet *al.*, 2000). The effect of application of organic amendments like vermicompost on crop yield and production is derived from the plant nutrients, particularly nitrogen (Woodbury, 1992; Maynard, 1993; Ozores-Hampton *et al.*, 1994). Organic phosphorus solubilized by microbial activity in composts like the vermicompost is more effective for plant absorption (Mishra and Banger, 1986; Singh *et al.*, 1987). The reduced cost of cultivation, less cost-benefit ratio and higher net income has been recorded in wheat and paddy cultivation through Vermitech compared with the use of chemical fertilisers along with the other economically important crops like peanut (*Arachis hypogaea*) and brinjal (*Solanum melongena*) by organic methods (Ismail, 1997). Organic farming has proved to be environment friendly, sustainable and cost effective (Reganold *et al.*, 2001).

Experiments on the effect of earthworms and vermicompost on the cultivation of vegetables like tomato (*Lycopersicon esculentum*), brinjal (*Solanum melongena*) and okra (*Abelmoschus esculentus*) have yielded significant results (Ismail, 1997). Vermicompost as an organic input has been applied to grow vegetables and other crops successfully (Ismail, 1997). Application of composts like vermicompost could contribute to increased availability of food (Ouedraogo *et al.*, 2001). This is attributed to better growth of plants and higher yield by slow release of nutrients for absorption with additional nutrients like gibberellin, cytokinin and auxins, by the application of organic inputs like vermicompost in combination with vermiwash (Raviv *et al.*, 1998; Singh *et al.*, 1998; Subler *et al.*, 1998; Lalitha *et al.*, 2000). The yield of potato and the average weight of potato tubers were significantly higher in plots treated with vermicompost (Table 46). This may be attributed to increased bioavailability of phosphorus by the application of organic amendment in the form of vermicompost (Erich *et al.*, 2002).

Organic manure like vermicompost and vermiwash, when added to soil, augment crop growth and yield (Lalitha *et al.*, 2000). The yields of spinach and onion in response to diluted vermiwash along with vermicompost was highly significant which may be due to increased availability of more exchangeable nutrients in the soil by the application of vermiwash along with vermicompost (Ponomareva, 1950; Finck, 1952; Nijhawan and Kanwar, 1952; Nye, 1955; Atlavinyte and Vanagas, 1973, 1982; Czerwinski *et al.*, 1974; Watanabe, 1975; Cook *et al.*, 1980; Tiwari *et al.*, 1989). Concern about the environment and the economic and social impacts of chemical or conventional agriculture has led to many thinking groups seeking alternative practices that will make agriculture more suitable. Biodynamic farming practices and systems have shown promise in mitigating some of the detrimental effects of chemical-dependent, conventional agriculture on the environment (Reganold *et al.* 1993).

Conclusion

Soils are critical to productivity of both agriculture and natural ecosystems. Soil is an integral system, which is to be maintained through sustainability of nutrient resources. The continuous worldwide soil degradation by erosion, chemicals, acidification and physical abuse requires management in terms of soil quality. The use of organic amendments augmented with

Vermitechnology could be adopted as a means for crop production and soil stability. The use of combinations of organic amendments such as vermiwash, and vermicompost can effectively bring about an improvement in soil quality, enhance microbial population and impact crop productivity thereby bringing about long term sustainability. Considering all aspects, such as studies on soil, soil health, yield of crops and cost effectiveness of Vermitechnology as a means of microbial innovation, it is concluded such technology could be applied for sustainable soil enrichment and crop productivity.

References

- Ansari, A. A. 2008. Effect of Vermicompost on the productivity of Potato (*Solanum tuberosum*), Spinach (*Spinach oleracea*) and Turnip (*Brassica campestris*). *World Journal of Agricultural Sciences*, 4 (3): 333-336.
- Ansari, A. A., & Ismail, S. A. (2001). A case study on organic farming in Uttar Pradesh. *Journal of Soil Biology*, 27, 25-27.
- Ansari, A. A., & Sukhraj, K. (2010). Effect of Vermiwash and Vermicompost on soil parameters and productivity of okra (*Abelmoschus esculentus*) in Guyana. *Pakistan Journal of Agricultural Research*, 23 (3-4).
- Atlavinyte, O. and Vanagas, J. 1973. Mobility of nutritive substances in relation to earthworm numbers in the soil. *Pedobiologia*, 13: 344-352.
- Atlavinyte, O. and Vanagas, J. 1982. The effect of earthworms on the quality of barley and rye and grain. *Pedobiologia*, 23: 256-262.
- Borken, W., Muhs, A. and Beese, F. 2002. Changes in microbial and soil properties following compost treatment of degraded temperate forest soils. *Soil Biol. Biochem.*, 34: 403-412.
- Buchanan, R. A. and Gliessman, S. R. 1990. The influence of conventional and compost fertilization on phosphorus use efficiency by broccoli in a phosphorus deficient soil. *Am. J. Alt. Agric.*, 5: 38.
- Cook, A. G., Critchley, B. R., and Critchley, U. 1980. Effects of cultivation and DDT on earthworm activity in a forest soil in the sub-humid tropics. *J. Appl. Ecol.*, 17: 21-29.
- Czerwinski, Z., Jakubczyk, H. and Nowak, E. 1974. Analysis of sheep pasture ecosystem in the Pieniny Mountains (The Carpathians). XII. The effect of earthworms on pasture soil. *Ekol. Pol.*, 22: 635-650.
- De Vleeschauwer, D. D. and Lal, R. 1981. Properties of worm casts under secondary tropical forest regrowth. *Soil Sci.*, 132: 175.
- Dong, A., Chester, G. and Simsiman, G. V. 1983. Soil dispersibility. *J. Soil Sci.*, 136: 208.
- Edwards, A. P. and Bremner, J. M. 1967. Microaggregates in soils. *J. Soil Sci.*, 18: 64.
- Erich, M. S., Fitzgerald, C. B. and Porter, G. A. 2002. The effect of organic amendments on phosphorus chemistry in a potato cropping system. *Agric. Ecosys. Environ.* 88: 79-88.
- Finck, A. 1952. Ökologische und Bodenkundliche Studien über die Leistungen der Regenwürmer für die Bodenfruchtbarkeit. *Z. Pflernähr. Düng.*, 58: 120-145.
- Hamblin, A. P. 1977. Structural features of aggregates in some East Anglian silt soils. *J. Soil Sci.*, 28: 23.
- Haynes, R. J. 1986. The decomposition process mineralization, immobilisation, humus formation and degradation. In: *Mineral nitrogen in the plant-soil system* (Haynes, R. J. eds.), Academic Press, New York.
- Haynes, R. J. and Swift, R. S. 1990. Stability of soil aggregates in relation to organic constituents and soil water content. *J. Soil Sci.*, 41: 73.
- Ismail, S. A. 1997. *Vermicology: The Biology of Earthworms*. Orient longman Press, Hyderabad. 92 pp.
- Ismail, S.A. 2005. *The Earthworm Book*. Other India Press, Mapusa, Goa. 101.
- Kale, R. D. 1998. *Earthworm Cinderella of Organic Farming*. Prism Book Pvt Ltd, Bangalore, India. 88 pp.

- Kirk, J. L., Beandette, L. A., Hart, M., Moutoglis, P., Klironomos, J. N., Lee, H. and Trevors, J. T., 2004. Methods of Studying Soil Microbial diversity, *Journal of Microbiological Methods* 58, pp169-188.
- Krishnamoorthy, R. V. and Vajranabhaiah, S. N. 1986. Biological activity of earthworm casts: An assessment of plant growth promoter levels in the casts. *Proc. Indian Acad. Sci.(Anim. Sci.)*, 95: 341-351.
- Lalitha, R., Fathima, K. and Ismail, S. A. 2000. Impact of biopesticides and microbial fertilizers on productivity and growth of *Abelmoschus esculentus*. *Vasundhara The Earth.*, 1 & 2: 4-9.
- Maynard, A. 1993. Evaluating the suitability of MSW compost as a soil amendment in field growth tomatoes. Part A: yield of tomatoes. *Compost Sci. Util.*, 1: 34.
- Mishra, M. M. and Banger K. C. 1986. Rock phosphate comprising: transformation of phosphorus forms and mechanisms of solubilization. *Biol. Agric. Hort.*, 3: 331.
- Nath, G., Singh, K., & Singh, D. (2009). Chemical Analysis of Vermicomposts / Vermiwash of Different Combinations of Animal, Agro and Kitchen Wastes. *Australian Journal of Basic and Applied Sciences*, 3(4).
- Nijhawan, S. D. and Kanwar, J. S. 1952. Physicochemical properties of earthworm castings and their effect on the productivity of soil. *Indian J. Agric. Sci.*, 22: 357-373.
- Nye, P. H. 1955. Some soil-forming processes in the humid tropics. IV. The action of soil fauna. *J. Soil Sci.*, 6: 78.
- Ouédraogo, E., Mando, A. and Zombré, N. P. 2001. Use of compost to improve soil properties and crop productivity under low input agricultural system in West Africa. *Agric. Ecosys. Environ.*, 84: 259-266.
- Ozores-Hampton, M., Schaffer, B., Bryan, H. H. and Hanlon, E. A. 1994. Nutrient concentrations, growth and yield of tomato and squash in municipal solid-waste-amended soil. *Hort. Sci.*, 29: 785.
- Pagliai, M., Bisdom, E. B. A. and Ledin, S. 1983a. Changes in surface structure (crusting) after application of sewage sludges and pig slurry to cultivated agricultural soils in northern Italy. *Geoderma.*, 30: 35-53.
- Pagliai, M., La Marca, M. and Lucamante, G. 1983b. Micromorphometric and micromorphological investigations of a clay loam soil in viticulture under zero and conventional tillage. *J. Soil. Sci.*, 34: 391-403.
- Perucci, P. 1990. Effect of the addition of municipal solid-waste compost on microbial biomass and enzyme activities in soil. *Biol. Fertil. Soils.*, 10: 221.
- Ponomareva, S. I. 1950. The role of earthworms in the creation of a stable structure in ley rotations. *Pochvovedenie.*, 476-486.
- Pramoth, A. 1995. *Vermiwash-A potent bio-organic liquid “Ferticide”*. M.Sc., dissertation, University of Madras. 29 pp.
- Rajkhowa, D. J., Gogoi, A. K., Kandal, R. and Rajkhowa, K. M. 2000. Effect of vermicompost on Greengram nutrition. *J. Indian Soc. Soil Sci.*, 48: 207-208.
- Raviv, M., Zaidman, B. Z. and Kapulnik. Y. 1998. *Compost Science and Utilization.*, 6: 46-52.
- Reganold, J. P., Palmer, A. S., Lockhart, J. C. and Macgregor, A. N. 1993. Soil Quality and Financial Performance of Biodynamic and Conventional Farms in New Zealand. *Science.*, 260: 344-349.
- Reganold, J. P., Glover, J. D., Andrews, P. K. and Hinman, H. R. 2001. Sustainability of three apple production systems. *Nature.*, 410: 926-925.
- Rogaar, H. and Boswinkel, J. A. 1978. Some soil morphological effects of earthworm activity, field data and X-ray radiography. *Neth. J. Agric. Sci.*, 26: 145-160.
- Satchell, J. E. and Martin, K. 1984. Phosphatase activity in earthworm species. *Soil Biol. Biochem.*, 16: 191.

- Satchell, J. E., Martin, K. and Krishnamoorthy, R. V. 1992. Stimulation of microbial phosphatase production by earthworm activity. *Soil Biol. Biochem.*, 16: 195.
- Sharma, A. R. and Mitra, B. N. 1991. Effect of different rates of application of organic and nitrogen fertilisers in a rice- based cropping system. *J. Agric. Sci.*, 117: 313.
- Shipitalo, M. J. and Protz, R. 1988. Factors influencing the dispersibility of clay in worm casts. *Soil Sci. Soc. Am. J.*, 52: 764-769.
- Singh, C. P., Singh, Y. P. and Singh, M. 1987. Effect of different carbonaceous compounds on the transformation of soil nutrients. II. Immobilization and mineralization of phosphorus. *Biol. Agric. Hort.*, 4: 301.
- Smith, S. R. 1992. Sewage sludge and refuse composts as peat alternatives for conditioning impoverished soils: effects on the growth response and mineral status of *Petunia grandiflora*. *J. Hort. Sci.*, 67: 703.
- Subler, S., Edwards, C. A. and Metzger, J. 1998. *Biocycle.*, 39: 63-66.
- Tisdale, J. L. and Oades, J. M. 1982. Organic matter and water-stable aggregates in soil. *J. Soil Sci.*, 33: 141.
- Tiwari, S. C., Tiwari, B. K. and Mishra R. R. 1989. Microbial populations, enzyme activities and nitrogen-phosphorus-potassium enrichments in earthworm casts and in the surrounding soil of a pineapple plantation. *Biol. Fertil. Soils.*, 8: 178-182.
- Watanabe, H. 1975. On the amount of cast production by the megascolecid earthworm *Pheretima hupeiensis*. *Pedobiologia.*, 15: 20-28.
- Woodbury, P. B. 1992. Trace elements in municipal solid waste composts: a review of potential detrimental effects on plants, soil biota, and water quality. *Biomass and Bioenergy.*, 3: 239.

ASSESSMENT, REFINEMENT AND VALIDATION OF THE ECOFRIENDLY MANAGEMENT TECHNOLOGY FOR THE OF POD BORER, *Helicoverpa armigera* (Hubner) IN CHICKPEA

WAJID HASAN

Krishi Vigyan Kendra, Jahanabad, Bihar Agricultural University, Sabour, Bihar, India

ABSTRACT

Pod borer *Helicoverpa armigera* (Hubner) is a major and most serious one threat in chickpea production. It can damage an average 30 to 40 per cent pod. In favorable condition pod damage goes 90-95 per cent. A single caterpillar of this pest can damage 25-40 pods. The On Farm Trials conducted at farmers field in Jehanabad district of Bihar for Assessment, refinement and validation of the ecofriendly management technology for the of pod borer, *Helicoverpa armigera* (Hubner) in chickpea during rabi 2020-2021 and during rabi 2021-2022.

Results revealed that the higher yield of chickpea (15.09 q/ha) and 2.37 BC ratio with 11.78 per cent pod infestation were recorded in plots treated with Two spray of azadirachtin 3000ppm @ 10 ml/ltr water followed by plots treated with Erect Bird perches @40/ha+ Pheromone trap @20/ha the yield (14.88 q/ha) and 2.34 BC ratio with 11.14 per cent pod infestation observed. Whereas plots treated with Chlorpyrifos 20 EC @ 1500ml/ha the yield (14.71 q/ha) and 2.31 BC ratio with 12.55 per cent pod infestation were recorded during rabi 2020-2021. Whereas during rabi 2021-2022, the higher yield of chickpea (15.7 q/ha) and 2.47 BC ratio with 10.60 per cent pod infestation were recorded in plots treated with Two spray of azadirachtin 3000ppm @ 10 ml/ltr water followed by plots treated with Erect Bird perches @40/ha+ Pheromone trap @20/ha the yield (15.3 q/ha) and 2.36 BC ratio with 10.86 per cent pod infestation observed. Whereas plots treated with Chlorpyrifos 20 EC @ 1500ml/ha the yield (15.0 q/ha) and 2.36 BC ratio with 10.82 per cent pod infestation were recorded. Farmers was actively participated with adaptation of the technology during the study.

Therefore, it can be concluded that the Ecofriendly treatment (Erect Bird perches @40/ha+ Pheromone trap @20/ha and two spray of azadirachtin 3000ppm @ 10 ml/ltr water) treated plots produce marginally higher yield and reduce *Helicoverpa* infestation. For Ecofriendly Management of pod borer, *H. armigera* in chickpea the technology Erect Bird perches @40/ha+ Pheromone trap @20/ha and two spray of azadirachtin 3000ppm @ 10 ml/ltr water at Pre flowering and Pod formation is recommended.

FEEDING PREFERENCE OF BANANA LEAF AND FRUIT SCARRING BEETLE, *Nodostoma subcostatum* (Jacoby) In Banana Germplasms

FOUZIA BARI¹, WAJID HASAN², NILANJANA CHAUDHURY³ AND S.K.SENAPATI⁴

^{1,3,4}Department of Entomology. Uttar Banga Krishi Vishwavidyalaya, Cooch Behar 736165.
West Bengal

²Krishi Vigyan Kendra, Jahanabad, BAU, Sabour. 804432. Bihar

ABSTRACT

India rank first in banana production and productivity. Banana leaf and fruit scarring beetle *Nodostoma subcostatum* (Jacoby) has been recognized as a most serious pest in north eastern region of India. Field experiment was conducted to study the feeding preference of banana leaf and fruit scarring beetle *Nodostoma subcostatum* (Jacoby) in different germplasms of banana namely Katchakela, Bichikela, Modhubash, Chini Malbhog, Malbhog, G9, G9 Tissue Culture, Red Banana, Manua, Thellachakra keli, Amrit Sagar and Amrit Sagar Tissue Culture, at horticultural instructional farm, UBKV by following all the recommended agronomic practice, uniformly keeping the plot completely free from insecticidal application during 2018-20. Periodical observations revealed almost all banana plants from vegetative to reproductive stage were found infested from Banana leaf and fruit scarring beetle *Nodostoma subcostatum* (Jacoby). Observation was recorded on the basis of no. of scars per 20 cm² area of leaves on 20 randomly selected young emerged leaves and fruit. Experimental result revealed that the maximum scars per 20 cm² area of leaf were recorded on G9 followed by G9 Tissue Culture and minimum scar/cm² was recorded in Red Banana followed by Manua. All the data were recorded at weekly interval during the first week of March to last week of February in both the year revealed that scars reach to its peak on August and gradually decreased from November and again progressively increased from March. The damage done by this beetle caused tremendous influence on both quality and quantity of banana with special reference to scars, skin color and thickness, taste, smell and pulp of fruit.

Keywords: Banana, Scarring beetle, Scar, Variety, Infestation, Malbhog.

RELATIVE EFFICACY OF DIFFERENT INSECTICIDES AND BIOPESTICIDES ON APHID AND THEIR NATURAL ENEMIES

BHAVNA VERMA¹ AND WAJID HASAN²

¹Directorate of Plant Protection Quarantine & Storage CIPMC Indore, P.M., India

²Krishi Vigyan Kendra, Jahanabad, Bihar Agricultural University, Bihar, India

Chilli, *Capsicum annum* Linnaeus belongs to the family Solanaceae is one of the important commercial vegetable crops grown in all over India. Being a crop of tropical and sub-tropical region, it requires a warm humid climate. In India nearly 25 insects have been recorded attacking chilli leaves and fruits, among the plethora of constraints in chilli cultivation, the attack by a multitude of insect pests and mites at different crop stages is of utmost concern.

Studies were carried out at Samajik Vigyan Kendra, Dr. B. R. Ambedkar University Rehti, (Village Bordi) Tehsil - Nasrullaganj, Distt- Sehore (M.P.) during *Rabi*, 2018-19 and 2019-20. The chilli variety ‘HPH-12’ recommended for this region was used for the experiment. Total ten treatments including untreated control were taken for test their efficacy. On the basis of mean per cent reduction in aphid population in all the three sprays the maximum population reduction percent was observed in emamectin benzoate 5 SG (79.08%) followed by thiamethoxam 25 WG (77.97%), spinosad 45 SC (74.36%), fipronil 5 SC (73.81%), carbosulfan 25 EC (73.11%), fenprothrin 30 EC (72.04%), bifenthrin 10 EC (71.64%),

propalgite 57 EC (70.16%) and minimum percentage of reduction in aphid population was recorded in the neem (66.68). The observation during both the years of study, the Natural Enemies (green lace wing, coccinellids and spiders) population was observed on five randomly selected plants from each plot before 1st spray and 14 days after each spray. The population of Natural Enemies was found in the range of 3.80 to 9.04 per five plants respectively and showed non-significant difference. After each spray on different intervals, the population of Natural Enemies was almost similar in higher doses of insecticides and in untreated control and showed non-significant difference. The descending order of insecticides effective in controlling this pest and their order of efficacy was Emamectin benzoate > thiamethoxam > spinosad > fipronil > carbosulfan > fenpropathrin > bifenthrin > propalgite & neem. The maximum reduction in aphid population was recorded in the treatment of emamectin benzoate (79.08%), followed by thiamethoxam (77.97%), spinosad (74.36%), fipronil (73.81%) and carbosulfan (73.11%) and minimum reduction was recorded in the treatment of neem (66.68%). The population of potential predator like *Coccinellid*, green lace wing and spiders, were recorded at different intervals. In pretreatment observations the natural enemies population found in the range of 3.80 to 9.04 respectively and showed non-significant difference. After each spray on different intervals, the population of predators was almost similar in higher doses of insecticides and in untreated control and showed non-significant difference.

Keywords: Chilli (*Capsicum annum* L.), aphid, Natural Enemies, efficacy, insecticides, biopesticides

EFFECT OF INTER ROW SPACING WITH OR WITHOUT WEED CONTROL IN WHEAT (*Triticum aestivum* L.).

F.S. ABD EL-SAMIE¹, EKRAM, A. MEGAWER¹, H.H.M. HUSSEIN², AND SARA, M. MOHAMED¹

1. Agronomy Department, Faculty of Agriculture, Fayoum University, Egypt

2- Agronomy Department, Faculty of Agriculture, Ain Shams University, Egypt

ABSTRACT

Two field trials were conducted during the two successive summer growing seasons of 2019 and 2020, at the Experimental Farm, Faculty of Agriculture, Fayoum University Fayoum Governorate, Egypt. A split- split design with three replicates was used. The main plots were assigned three water stress treatments (skipping of some irrigations) as follows: normal irrigation (7 irrigations) i.e., control treatment, missing the 4th irrigation (64 DAP), and missing the 6th irrigation (78 DAP). The sub-plots were restricted to three yellow single cross hybrids of maize, i.e. single cross hybrid 2055, single cross hybrid 2066 and single cross hybrid 2088, and the sub-sub plots received three concentrations Calcium carbonate nanoparticles i.e. 500 g fed⁻¹, 750 g fed⁻¹ and 100 g fed⁻¹. The results showed that irrigation treatment reflected positive significant influences on growth parameters, normal irrigation resulted in the best mean values of plant height, maximum number of leaves plant⁻¹, largest leaf area plant⁻¹ and heaviest dry weight plant⁻¹ in both seasons 65 and 80 (DAS). Irrigation treatments had a significant effect on number of days from sowing to 50% tasseling in the two growing seasons. The maximum number of days from sowing to 50% tasseling due to irrigation were produced from the normal irrigation compared with the other irrigation treatments {(Withholding the 4th irrigation (64 DAP) and Withholding the 5th irrigation (78 DAP)}. Results showed that yellow single cross hybrids of maize were significantly differed in almost mean values of maize growth, under study in the both seasons. Maize hybrid of S. C. 2088 was significantly surpassed S. C. 2055 and S. C. 2066 in mean values of all growth characters. Calcium carbonate nanoparticles

concentrations had a significant effect on growth parameters i. e. plant height, number of leaves/plant-1, dry weight plant-1, and total dry weight of plant in both seasons at 65 and 80 DAS. Data revealed that ear characters i.e. (ear height, ear length, ear diameter, ear weight, number of row/ear, number of grain /row) significantly affected by different irrigation treatments. Normal irrigation produced the highest values. There was significant effect on ear characters i.e. (ear height, ear length, ear diameter, ear weight, number of row/ear, number of grain /row) between different yellow single cross hybrids of maize. S. C. 2088 was significantly surpassed S. C. 2055 and S. C. 2066 in mean values of all ear characters. Application of Calcium carbonate nanoparticles as nano-fertilizers was pioneer and significantly resulted in characters i.e. (ear height, ear length, ear diameter, ear weight, number of row/ear, number of grain /row), high rate of Calcium carbonate nanoparticles produced the highest values.

Key words: Maize, Water stress, Calcium carbonate nanoparticles, yield and its components.

ASSESSING CLIMATE CHANGE POTENTIAL OF RECYCLING END-OF-LIFE PRODUCTS: AN LCA STUDY

PRAKASH POKHREL*, SHENG-LUNG LIN

Chaoyang University of Technology, Taichung, Taiwan (R.O.C)

Purpose

Greenhouse gases (GHG) emission, ozone layer depletion, ecological toxicity, agricultural and natural land transformation are the major impact categories affected recently by industrialization. Production of goods requires a huge amount of energy and resources which are converted to waste if not given second life via recycling, reuse, or repair. Studies have exhibited that recycling end-of-life (EoL) product is not always environmental friendly, therefore it is of paramount importance to assess these impacts on the environment (Maani et al., 2020).

Lifecycle assessment (LCA) is a widely used tool to assess the environmental impacts of a service or product during its entire lifecycle i.e. resource extraction to final fate (ISO 14040:2006, 2006). This tool uses different methods to analyze the environmental impacts by quantifying the resources used (inputs) and the emissions (outputs) resulting from the process or serves in various impacts categories of the environment including human health.

Methods

An end-of-life car is taken as a sample to assess the GHG emissions, ozone depletion potential, and other impact categories using an LCA. SimaPro accompanied by the Ecoinvent database was used in the study. The input/output data were assessed from a local recycling company in Taichung, Taiwan disassembling a hatchback car. The ILCD 2011 Midpoint+ method was used to calculate the environmental performance. This method converts resource and energy used and pollution emissions into damage information in terms of different 16 midpoint impacts categories like climate change, ozone depletion, ecological toxicity, natural resources depletion, etc.

Results

The results exhibited that there is a high impact on human toxicity, freshwater ecotoxicity, and resource depletion however there are negligible impacts on climate change, ozone depletion, and photochemical ozone formation (Fig. 1). The results support recycling of EoL vehicles which can be an important factor in the impacts minimization especially the climate change, ozone depletion, and photochemical ozone formation.

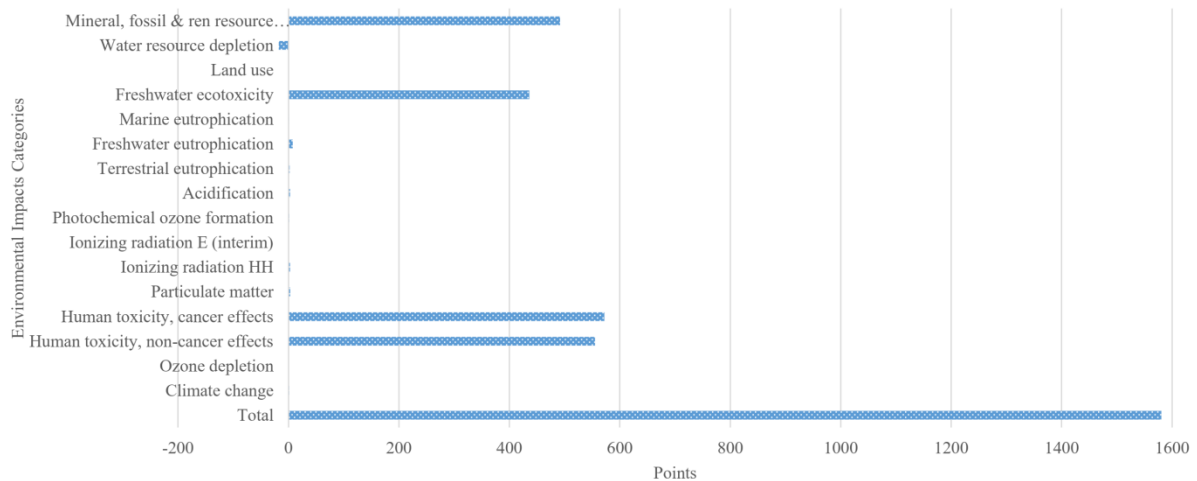

Fig.1. Normalized value for each environmental impact category for recycling a hatchback car in Taiwan.

Conclusions

The recycling of EoL vehicles exhibited that the climate change potential can be minimized with a reduced amount of ozone depletion and photochemical ozone formation. Albeit few studies reveal that recycling can be environmental impactful with higher emission of GHGs and photochemical ozone formation but recycling of EoL products can reduce these impact potential by minimizing the emissions to the environment.

Keywords: Lifecycle assessment (LCA), Recycling, Climate change, ozone depletion

Reference

- ISO 14040:2006. (2006). Environmental management—life cycle assessment—Principles and framework. *International Organization for Standardization*, 20.
- Maani, T., Celik, I., Heben, M. J., Ellingson, R. J., & Apul, D. (2020). Environmental impacts of recycling crystalline silicon (c-SI) and cadmium telluride (CDTE) solar panels. *Science of The Total Environment*, 735, 138827. <https://doi.org/10.1016/J.SCITOTENV.2020.138827>

AMELIORATION OF WATER STRESS BY POTASSIUM FERTILISER UNDER HIGH TEMPERATURES ON THE OIL PALM GROWTH, CARBON ASSIMILATION, AND BIOCHEMICAL CHANGES

TUAN SYARIPAH NAJIHAH, MOHD HAFIZ IBRAHIM, NURUL AMALINA MOHD ZAIN, ROSIMAH NULIT, PUTERI EDAROYATI MEGAT WAHAB
Universiti Sultan Zainal Abidin, Malaysia

Purpose

High temperature stress is a major environmental stress that limits plant growth and development. Even worse, crops routinely experience several different abiotic stress factors simultaneously. Thus, this research was designed to investigate the effect of elevated temperature on the physiology of *Elaeis guineensis* seedlings, to examine the combination of heat and water stress as well as to explore the potential of potassium (K) fertiliser in alleviating these stresses.

Methods

Three-month-old oil palm seedlings were arranged in randomised completely block design (RCBD) and treated with six regimes: A (well-watered + control amount of KCL + 30°C), B (well-watered + control amount of KCL + 32°C), C (moderate water stress + double rate of K₂SO₄ + 30°C), D (moderate water stress + double rate of K₂SO₄ + 32°C), E (severe water stress + double rate of KNO₃ + 30°C) and F (severe water stress + double rate of KNO₃ + 32°C).

Results

The results showed heat stress decreased vegetative plant growth, plant water status, and increased leaf temperature. The effect is exacerbated by the combination of water stress. However, there was no significant effect of high temperature on the plant leaf gas exchange, water use efficiency, f_v/f_m , chlorophyll content, and biochemical properties of the palms.

Conclusions

The present study suggests that only the growth of oil palms seedlings is sensitive to the 2°C rise, but not leaf gas exchange and biochemical attributes. Potassium fertiliser can play a protective role during moderate water stress under ambient temperature.

Key words: Oil palm, high temperature, water stress, potassium fertiliser, physiology

IMPORTANCE OF RICE BREEDING BIOFORTIFICATION FOR GRAIN ZN IMPROVEMENT AND FOOD SECURITY

CALLEY DEBRA YASING, LUM MOK SAM AND MD. AMIRUL ALAM
Faculty of Sustainable Agriculture, Universiti Malaysia Sabah (UMS), Sandakan Campus,
Sandakan, Sabah, Malaysia

Summary

Rice served as the primary source of calories and nutrition in Asian countries. However, it has low Zn content. It was reported that more than one billion individuals encountered health issues associated with zinc (Zn) deficiency, especially children and pregnant women. Moreover, Zn deficiency was more likely to happen in a population that depends greatly on calorie-rich diets and unaffordability to a diverse diet. Biofortification or also known as biological fortification has been reported to be a practical and economical way of enhancing the Zn content in rice. Hence, biofortification through rice breeding of local rice varieties with high-yielding Zn-enriched rice can be feasible means of delivering Zn-rich rice to people.

Review Background

Zinc is a crucial micronutrient in organisms as it has an important role as a catalyst, structural, and regulatory ion (Chasapis *et al.*, 2012). Zn is considered a highly versatile catalytic cofactor in protein as it has distinct chemical properties (Stanton *et al.*, 2022). Zn supplementation has a significant effect in treating COVID-19 patients which helps in improving cell-mediated and adaptive immunity against bacteria and virus infections (Rahman and Idid, 2021). Low intake of bioavailable Zn from foods is the primary cause of Zn deficiency (Lazarte *et al.*, 2016). Biofortification offers a practical way to reduce malnutrition problems, especially in rural areas having limited access to supplements and marketed biofortified food (Singh *et al.*, 2016). Even though it may not provide as high nutrition as supplements, biofortified food can help to address hidden hunger in the affected population (Bouis *et al.* 2011).

Conclusion

Rice breeding biofortification is a promising and sustainable way of conveying micronutrients to a rice-eating population with limited diet choices.

References

- Bouis, H. E., McClafferty, B., Meenakshi, J. V. and Pfeiffer, W. H. 2011. Biofortification: A New Tool to Reduce Micronutrient Malnutrition. *Food and Nutrition Bulletin* **32** (1): S31-S40.
- Chasapis, C. T., Loutsidou, A. C., Spiliopoulou, C. A. and Stefanidou, M. E. 2012. Zinc and Human Health: An Update. *Archives of toxicology* **86**: 521–534.
- Lazarte, C. E., Soto, A., Alvarez, L., Bergenstahl, B., Medrano, N. and Granfeldt, Y. 2016. Nutritional Status of Children with Intestinal Parasites from Tropical Area of Bolivia, Emphasis on Zinc and Iron Status. *Food Nutrition Science* **6**: 399-411
- Singh, U., Praharaj, C. S., Chaturvedi, S. K. and Bohra, A. 2016. Biofortification: Introduction, Approaches, Limitations, and Challenges. *Springer India*
- Stanton, C., Sanders, D., Kramer, U. and Podar, D. 2022. Zinc In Plants: Integrating Homeostasis and Biofortification. *Molecular plant* **15**: 65 – 68
- Rahman, M. T. and Idid, S. Z. 2021. Can Zn Be a Critical Element in COVID-19 Treatment. *Biological Trace Element Research* **199**: 550-558

TRICHODERMA: A MULTIFACETED FUNGUS FOR VERSATILE FUNCTIONALITIES

BIRESWAR SINHA*, KOTA CHAKRAPANI, Ph. SHOBITA DEVI, L.N.K. SINGH

Department of Plant Pathology, College of Agriculture, CAU, Imphal – 795004

ABSTRACT

The fungal genus that harbours *Trichoderma* is a large that holds numerous microbes which plays a significant role in environment. These microbes' possess diverse mechanisms to colonise various ecological niches. *Trichoderma* spp. are ubiquitous and are employed in multi-channel utilities in various fields that return undeniable results. *Trichoderma* are employed in Agriculture as biocontrol agent, additive that provides nutrition to plants, as a scavenger that clears agricultural waste by printing of various bio-chemicals that have a tremendous role. They are employed in industrial sector and environmental sector for production of various enzymes, antibiotics, metabolites that have outstanding functionalities and they are used for scavenging and degrading the soils that are polluted by heavy metals respectively. *Trichoderma* are used to control numerous insect pest that incur damage to both plant and humankind. Moreover, the genus *Trichoderma* comprises edible and medicinal mushrooms, but also the pathogens of humans. Currently, *Trichoderma* has entered the genomic era and parts of genome sequences are publicly available. This is why, *Trichoderma* fungi have the potential to be used for human needs to an even greater extent than before. Nevertheless, further studies are needed to increase the efficiency and safety of the application of these fungi.

Keywords: *Trichoderma*, Agriculture, Industry, Environment, Medicinal

CONVERT THIS HUGE BIOMASS OF BANANA CROP RESIDUE INTO DIFFERENT VALUE-ADDED PRODUCTS LIKE FIBRE, LIQUID FERTILIZER AND VERMI-COMPOST

SK SINGH* AND SHANKAR JHA**

“Development Project of Self-Reliant Banana Cultivation Module for Bihar” (Development of a self-reliant banana farming module for Bihar)”, Dr. Rajendra Prasad Central Agricultural University Pusa-848 125, Samastipur, Bihar

ABSTRACT

According to the data for the year 2017-18, banana cultivation in Bihar is done on 31.07 thousand hectares, and the average productivity of bananas is 44.94 metric tons/ha. Around 4 – 4.5 lakh people in Bihar are earning their livelihood from banana cultivation and allied activities. After harvesting of banana bunches, the pseudostem is thrown as such or burnt—the huge biomass generated after harvesting the crop damages the environment and pollutes the farm ecosystem. Besides, a huge amount of money gets invested in the disposal of such waste materials. It has been estimated that around 10 – 15 thousand rupees cost for disposal of such waste in the banana crop grown in a hectare of land. The scientific disposal of banana pseudostem may contribute to additional farm income apart from the bunch yield. Available data indicated that around 25 lakh tones of biomass are generated annually from bananas only in Bihar. The biggest challenge for the banana-growing community of Bihar is to convert this huge biomass of banana crop residue into different value-added products. Another challenge is to extract fibre, sap and other products from this biomass. Lastly, it is essential to persuade the banana growers to use the banana pseudostem sap as a growth promoter and the banana scraper as compost.

Keeping an eye on the above challenges, Dr Rajendra Prasad Central Agricultural University started working by forming a working group under a project funded by the University. The results of this project were very encouraging.

Now the findings are required to be disseminated among the farmers. Work has been started in this regard. Initially, it was a challenging task to change the mindset of the farmer, it was necessary to tell them through experiments that the banana pseudostem is none less than a gold mine. Banana pseudostem sap contains high valuable nutrients for the growth of various crops. The transportation of banana pseudostems is laborious as well as very expensive. The banana growers are made partner with this project. The growers can have a better profit and additional remuneration by forming clusters along with other farmers of that area for making fibre, sap and manure from the banana pseudostem. There will be a saving on the cost of disposal of pseudostem, organic liquid fertilizer and the use of vermi-manure/manure from the banana pseudostem can reduce the cost of chemical fertilizer. Employment can be generated at the village level through the cottage industry. Long-distance transport of banana pseudostem is not economically viable. It would be more economical to process the pseudostem of the banana and extract the fibre at the local village level.

PLANT GROWTH PROMOTING RHIZOBACTERIA: MULTITASKING MICROBES FOR PLANT GROWTH AND DISEASE MANAGEMENT UNDER CHANGING CLIMATIC AND PESTICIDE SCENARIO

GURURAJ SUNKAD

Dean (Post-Graduate Studies), Directorate of Post-Graduate Studies, University of Agricultural Sciences, Raichur, Karnataka

ABSTRACT

At least 10% of global food production is lost due to plant diseases, representing a threat to food security. The prevention of diseases mainly dependent on agro-chemicals especially from the past few decades. Despite the great effectiveness and ease of utilization of chemicals products, their use or misuse has led to hazardous effects to environment. In recent years, lot of research is going on for exploitation of plant growth promoting rhizobacteria (PGPR) for better plant growth as well as health for agricultural sustainability under changing climatic and indiscriminate pesticide usage scenario. Rhizosphere is the thin layer of soil surrounding the root zone of any plant and rich in nutrients, because of the photosynthetic exudates from the roots. The rhizosphere are said to be the areas of very high biological diversity teaming up with many different organisms, as the plant roots provide food, shelter and energy. This active microbial population can either exert beneficial or detrimental effects on the plant or they can be neutral. Some microorganisms are able to colonize the soil surrounding plant roots, the rhizosphere, making them come under the influence of plant roots.

PGPR generally refers to a group of soil and rhizosphere free-living bacteria colonizing roots in a competitive environment and exerting a beneficial effect on plant growth. Microbes play key role not only in transforming nutrients in the soil but also giving plant protection against pathogens. The beneficial effect of PGPR on plant growth involves the ability to act as phyto-stimulators or biofertilizers. PGPR could enhance crop yield through nutrient uptake and plant growth regulators. PGPR could also act as bio-control agents by the production of antibiotics and triggering induced local or systemic resistance. The exact mechanism by which PGPR stimulate plant growth is not clearly established, although several hypothesis such as production of phytohormones, suppression of deleterious organisms, HCN and siderophore production, activation of phosphate solubilization, volatile compound production and promotion of the mineral nutrient uptake and plant growth promotion are usually believed to be involved. PGPR includes both free living as well asymbiotic bacteria. Several PGPR have been studied and commercialized. They promote growth through suppression of plant diseases or improved nutrition acquisition or phytohormone production. Sustainable agriculture, based on environmentally-friendly methods, tends to use PGPR as tool that could as a by-product reduce the use of agro-chemicals. There is a great need for eco-friendly management of plant diseases through PGPR worldwide under changing climatic and indiscriminate pesticide usage scenario.

GENOME-WIDE ASSOCIATION STUDIES AND LINKAGE MAPPING FOR MAIZE IMPROVEMENT: A REVIEW

NGUYEN TRUNG DUC^{1*}, VU VAN LIET¹, PHAM QUANG TUAN¹, NGUYEN THI NGUYET ANH¹, NGUYEN QUOC TRUNG¹

¹ Vietnam National University of Agriculture, Hanoi 131000, Vietnam

ABSTRACT

Maize (*Zea mays* L.) is one of the most important crops throughout the world, have used for many purposes such as food, feed, fibers and biofuels. Therefore, improving maize productivity and qualities is always needed to feeding 10 billion people by 2050, achieve food security, and resilience to climate change. Genome-wide association studies (GWAS) is useful tool to identifying natural variation significantly associated with the target trait and exploring the underlying candidate genes. With the decreased of sequencing cost and increased resolution of genotyping, GWAS and linkage mapping have been utilized in many maize researches to investigate and dissect the plant architecture, grain composition and disease resistance. Unlike linkage mapping, present the limited recombination events and allelic diversity, GWAS harnesses historical recombination accumulated over generations in the natural populations. However, Strong linkage disequilibrium between the phenotype and non-causal common variant from population based may interfere with the detection of the causal rare variant have minor allele frequencies <0.05, leading to missing heritability and synthetic associations. Therefore, to complement the strengths and limitation of each approach, combined use of GWAS and linkage mapping has been successfully used to dissect the genetic basis and architecture of complex traits in corn. Furthermore, after pursuing GWAS and linkage mapping, the causal genes and associated markers should be focused on genetic relationship, regulation mechanism, and validated before transfer to breeding utilization.

Keywords: GWAS, linkage mapping, LD, natural variation, food security

SUSTAINABLE DEVELOPMENT AND ENVIRONMENT OF BIOMASS FROM AGRICULTURE RESIDUES

ABDEEN MUSTAFA OMER

Energy Research Institute (ERI), Nottingham NG7 4EU, United Kingdom

ABSTRACT

This communication discusses a comprehensive review of biomass energy sources, environment and sustainable development. This includes all the biomass energy technologies, energy efficiency systems, energy conservation scenarios, energy savings and other mitigation measures necessary to reduce emissions globally. This study highlights the energy problem and their possible saving that can be achieved through the use of biomass energy sources. Also, this study clarifies the background of the study, highlights the potential energy saving that could be achieved. The use of biomass energy source describes the objectives, approach and scope of the theme. However, to be truly competitive in an open market situation, higher value products are required. Results suggest that biomass technology must be encouraged, promoted, invested, implemented, and demonstrated as a whole while especially in remote rural areas.

Keywords: Biomass resources, wastes, woodfuel, biofuels, energy, environment

Introduction

There is strong scientific evidence that the average temperature of the earth's surface is rising every year. This was a result of the increased concentration of carbon dioxide (CO₂), and other

greenhouse gases (GHGs) in the atmosphere as released by burning fossil fuels [1-2]. This global warming will eventually lead to substantial changes in the world’s climate, which will, in turn, have a major impact on human life and the environment. Energy use can be achieved by minimising the energy demand, by rational energy use, by recovering heat and the use of more green energies. This will lead to fossil fuels emission reduction. This study was a step towards achieving this goal. The adoption of green or sustainable approaches to the way in which society is run is seen as an important strategy in finding a solution to the energy problem. The key factors of reducing and controlling CO₂, which is a major contributor to global warming, are the use of alternative approaches to energy generation and the exploration of how these alternatives are used today and may be used in the future as green energy sources. Even with modest assumptions about the availability of land, comprehensive fuel-wood farming programmes offer significant energy, economic and environmental benefits. These benefits would be dispersed in rural areas where they are greatly needed and can serve as linkages for further rural economic development. The nations as a whole would benefit from savings in foreign exchange, improved energy security, and socio-economic improvements. With a nine-fold increase in forest – plantation cover, the nation’s resource base would be greatly improved. The non-technical issues, which have recently gained attention, include:

Environmental and ecological factors, e.g., carbon sequestration, reforestation and revegetation.

Renewables as a CO₂ neutral replacement for fossil fuels.

Greater recognition of the importance of renewable energy, particularly modern biomass energy carriers, at the policy and planning levels.

Greater recognition of the difficulties of gathering good and reliable biomass energy data, and efforts to improve it.

Studies on the detrimental health effects of biomass energy particularly from traditional energy users.

There is a need for some further development to suit local conditions, to minimise spares holdings, to maximise interchangeability both of engine parts and of the engine application. Emphasis should be placed on full local manufacture [3]. Energy is an essential factor in development since it stimulates, and supports economic growth and development. Fossil fuels, especially oil and natural gas, are finite in extent, and should be regarded as depleting assets, and efforts are oriented to search for new sources of energy. The clamour all over the world for the need to conserve energy and the environment has intensified as traditional energy resources continue to dwindle whilst the environment becomes increasingly degraded. Alternatively energy sources can potentially help fulfill the acute energy demand and sustain economic growth in many regions of the world. Bioenergy is beginning to gain importance in the global fight to prevent climate change. The scope for exploiting organic waste as a source of energy is not limited to direct incineration or burning refuse-derived fuels. Biogas, biofuels and woody biomass are other forms of energy sources that can be derived from organic waste materials. These biomass energy sources have significant potential in the fight against climate change [4]. Conservation of energy and rationing in some form will however have to be practised by most countries, to reduce oil imports and redress balance of payments positions. Meanwhile development and application of nuclear power and some of the traditional solar, wind, biomass and water energy alternatives must be set in hand to supplement what remains of the fossil fuels. The encouragement of greater energy use is an essential component of development. In the short-term it requires mechanisms to enable the rapid increase in energy/capita, and in the long-term we should be working towards a way of life, which makes use of energy efficiency and without the impairment of the environment or of causing safety problems [5].

The objective of this article is to highlight problems related to biomass applications and suggest methods to overcome these problems. This will be achieved through a comprehensive literature review of biomass, their application and the related problems.

The current literature is reviewed regarding the ecological, social, cultural and economic impacts of biomass technology. This study gives an overview of present and future use of biomass as an industrial feedstock for production of fuels, chemicals and other materials

Materials and Methods

The aim of any modern biomass energy systems must be:

To maximise yields with minimum inputs.

Utilisation and selection of adequate plant materials and processes.

Optimum use of land, water, and fertiliser.

Create an adequate infrastructure and strong R and D base.

Different techniques and methods employed to maintain and provide specific environments in bioenergy will also be assessed. In order to evaluate the effectiveness of the suggested methods, a literature review is compiled and presented. Determine the suitability of biomass technology for heating, cooling and other applications. Verify and document the savings in energy use and demand that biomass may be expected to achieve.

2.1. Bioenergy Development

Bioenergy is energy from the sun stored in materials of biological origin. This includes plant matter and animal waste, known as biomass. Plants store solar energy through photosynthesis in cellulose and lignin, whereas animals store energy as fats. When burned, these sugars break down and release energy exothermically, releasing carbon dioxide (CO₂), heat and steam. The by-products of this reaction can be captured and manipulated to create power, commonly called bioenergy. Biomass is considered renewable because the carbon (C) is taken out of the atmosphere and replenished more quickly than the millions of years required for fossil fuels to form. The use of biofuels to replace fossil fuels contributes to a reduction in the overall release of carbon dioxide into the atmosphere and hence helps to tackle global warming [6].

Table 1. Sources of energy [7]

Energy source	Energy carrier	Energy end-use
Vegetation	Fuel-wood	Cooking Water heating Building materials Animal fodder preparation
Oil	Kerosene	Lighting Ignition fires
Dry cells	Dry cell batteries	Lighting Small appliances
Muscle power	Animal power	Transport Land preparation for farming Food preparation (threshing)
Muscle power	Human power	Transport Land preparation for farming Food preparation (threshing)

Table 2. Renewable applications [8]

Systems	Applications
Water supply	Rain collection, purification, storage and recycling
Wastes disposal	Anaerobic digestion (CH ₄)
Cooking	Methane

Food	Cultivate the 1 hectare plot and greenhouse for four people
Electrical demands	Wind generator
Space heating	Solar collectors
Water heating	Solar collectors and excess wind energy
Control system	Ultimately hardware
Building fabric	Integration of subsystems to cut costs

The biomass energy resources are particularly suited for the provision of rural power supplies and a major advantage is that equipment such as flat plate solar driers, wind machines, etc., can be constructed using local resources and without the high capital cost of more conventional equipment. Further advantage results from the feasibility of local maintenance and the general encouragement such local manufacture gives to the build up of small-scale rural based industry. Table 1 lists the energy sources available. Currently the ‘non-commercial’ fuels wood, crop residues and animal dung are used in large amounts in the rural areas of developing countries, principally for heating and cooking; the method of use is highly inefficient. Table 2, 3 and 4 presented some renewable applications, the most important of energy needs and methods of energy conversion respectively.

Considerations when selecting power plant include the following:

Power level- whether continuous or discontinuous.

Cost- initial cost, total running cost including fuel, maintenance and capital amortised over life.

Complexity of operation.

Maintenance and availability of spares.

Life and suitability for local manufacture.

Table 3. Energy needs in rural areas [8]

Transport, e.g., small vehicles and boats
Agricultural machinery, e.g., two-wheeled tractors
Crop processing, e.g., milling
Water pumping
Small industries, e.g., workshop equipment
Electricity generation, e.g., hospitals and schools
Domestic, e.g., cooking, heating, and lighting

Table 4. Methods of energy conversion [10]

Muscle power	Man, animals
Internal combustion engines	
Reciprocating	Petrol- spark ignition Diesel- compression ignition Humphrey water piston Gas turbines
Rotating	
Heat engines	
Vapour (Rankine)	
Reciprocating	Steam engine
Rotating	Steam turbine
Gas Stirling (Reciprocating)	Steam engine
Gas Brayton (Rotating)	Steam turbine
Electron gas	Thermionic, thermoelectric
Electromagnetic radiation	Photo devices
Hydraulic engines	Wheels, screws, buckets, turbines
Wind engines (wind machines)	Vertical axis, horizontal axis
Electrical/mechanical	Dynamo/alternator, motor

The internal combustion engine is a major contributor to rising CO₂ emissions worldwide and some pretty dramatic new thinking is needed if our planet is to counter the effects. With its use increasing in developing world economies, there is something to be said for the argument that the vehicles we use to help keep our inner-city environments free from waste, litter and grime should be at the forefront of developments in low-emissions technology. Materials handled by waste management companies are becoming increasingly valuable. Those responsible for the security of facilities that treat waste or manage scrap will testify to the precautions needed to fight an ongoing battle against unauthorised access by criminals and crucially, to prevent the damage they can cause through theft, vandalism or even arson. Of particular concern is the escalating level of metal theft, driven by various factors including the demand for metal in rapidly developing economies such as India and China [9].

There is a need for greater attention to be devoted to this field in the development of new designs, the dissemination of information and the encouragement of its use. International and government bodies and independent organisations all have a role to play in biomass energy technologies. Environment has no precise limits because it is in fact a part of everything. Indeed, environment is, as anyone probably already knows, not only flowers blossoming or birds singing in the spring, or a lake surrounded by beautiful mountains. It is also human settlements, the places where people live, work, rest, the quality of the food we eat, the noise or silence of the street they live in. Environment is not only the fact that our cars consume a good deal of energy and pollute the air, but also, that we often need them to go to work and for holidays. Obviously, man uses energy just as plants, bacteria, mushrooms, bees, fish and rats do (Figure 1). Man, largely uses solar energy- food, hydropower, wood- and thus participates harmoniously in the natural flow of energy through the environment. But man also uses oil, gas, coal and nuclear power. We always modify our environment with or without this source of energy [11]. Economic importance of environmental issue is increasing, and new technologies are expected to reduce pollution derived both from productive processes and products, with costs that are still unknown. This is due to market uncertainty, weak appropriability regime, lack of a dominant design, and difficulties in reconfiguring organisational routines. The degradation of the global environment is one of the most serious energy issues [12].

3. Energy Use and the Environment

The range of waste treatment technologies that are tailored to produce bioenergy is growing. There are a number of key areas of bioenergy from wastes including (but not limited to) biogas, biofuels and bioheat.

Table 5. Annual GHG emissions from different types of power plants [13]

Primary source of energy	Emissions (x 10 ³ metric tons CO ₂)		Waste (x 10 ³ metric tons CO ₂)	Area (km ²)
	Atmosphere	Water		
Coal	380	7-41	60-3000	120
Oil	70-160	3-6	Negligible	70-84
Gas	24	1	-	84
Nuclear	6	21	2600	77

Table 6. Energy consumption per person [13]

Region	Population (millions)	Energy per person (Watt/m ²)
Africa	820	0.54
Asia	3780	2.74
Central America	180	1.44
North America	335	0.34
South America	475	0.52

Western Europe	445	2.24
Eastern Europe	130	2.57
Oceania	35	0.08
Russia	330	0.29

When considering using bioenergy, it is important to take into account the overall emission of carbon in the process of electricity production. Energy use is one of several essential components for every country:

The overall situation and the implications of increased energy use in the future.

The problem of the provision of power in rural areas, including the consideration of energy resources and energy conversion. In addition to the drain on resources, such an increase in consumption consequences, together with the increased hazards of pollution and the safety problems associated with a large nuclear fission programmes. It would be equally unacceptable to suggest that the difference in energy between the developed and developing countries and prudent for the developed countries to move towards a way of life which, whilst maintaining or even increasing quality of life, reduce significantly the energy consumption per capita. Such savings can be achieved in a number of ways:

Improved efficiency of energy use, for example environmental cost of thermal insulation must be taken into account, energy recovery, and total energy.

Conservation of energy resources by design for long life and recycling rather than the short life throwaway product and systematic replanning of our way of life, for example in the field of transport.

Energy ratio (Er) is defined as the ratio of Energy content (Ec) of the food product / Energy input (Ei) to produce the food.

$$Er = Ec/Ei \quad (1)$$

Combined heat and power (CHP) installations are quite common in greenhouses, which grow high-energy, input crops (e.g., salad vegetables, pot plants, etc.). Scientific assumptions for a short-term energy strategy suggest that the most economically efficient way to replace the thermal plants is to modernise existing power plants to increase their energy efficiency and to improve their environmental performance (Pernille, 2004).

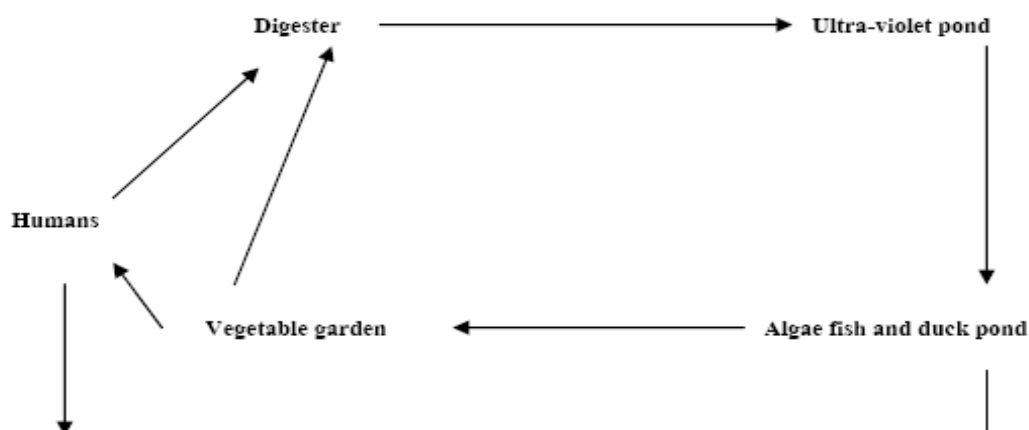

Figure 1. Biomass utilisation cycle concepts [14].

Table 7. Summary of material recycling practices in the construction sector [15]

Construction and demolition material	Recycling technology options	Recycling product
Asphalt	Cold recycling; heat generation; Minnesota process; parallel drum process; elongated drum; microwave asphalt recycling system; finfalt; surface regeneration	Recycling asphalt; asphalt aggregate
Brick	Burn to ash, crush into aggregate	Slime burn ash; filling material; hardcore
Concrete	Crush into aggregate	Recycling aggregate; cement replacement; protection of levee; backfilling; filter
Ferrous metal	Melt; reuse directly	Recycled steel scrap
Glass	Reuse directly; grind to powder; polishing; crush into aggregate; burn to ash	Recycled window unit; glass fibre; filling material; tile; paving block; asphalt; recycled aggregate; cement replacement; manmade soil
Masonry	Crush into aggregate; heat to 900oC to ash	Thermal insulating concrete; traditional clay
Non-ferrous metal	Melt	Recycled metal
Paper and cardboard	Purification	Recycled paper
Plastic	Convert to powder by cryogenic milling; clopping; crush into aggregate; burn to ash	Panel; recycled plastic; plastic lumber; recycled aggregate; landfill drainage; asphalt; manmade soil
Timber	Reuse directly; cut into aggregate; blast furnace deoxidisation; gasification or pyrolysis; chipping; moulding by pressurising timber chip under steam and water	Whole timber; furniture and kitchen utensils; lightweight recycled aggregate; source of energy; chemical production; wood-based panel; plastic lumber; geofibre; insulation board

Combined heat and power (CHP) installations are quite common in greenhouses, which grow high-energy, input crops (e.g., salad vegetables, potted plants, etc.). Scientific assumptions for a short-term energy strategy suggest that the most economically efficient way to replace the thermal plants is to modernise existing power plants to increase their energy efficiency and to improve their environmental performance [15]. However, utilisation of wind power and the conversion of gas-fired CHP plants to biomass would significantly reduce the dependence on imported fossil fuels. Although a lack of generating capacity is forecasted in the long-term, utilisation of the existing renewable energy potential and the huge possibilities for increasing energy efficiency are sufficient to meet future energy demands in the short-term [15]

A total shift towards a sustainable energy system is a complex and long process, but is one that can be achieved within a period of about 20 years. Implementation will require initial investment, long-term national strategies and action plans. However, the changes will have a

number of benefits including a more stable energy supply than at present and major improvement in the environmental performance of the energy sector, and certain social benefits (Figure 2). A vision that used methodologies and calculations based on computer modelling can utilised:

Data from existing governmental programmes.

Potential renewable energy sources and energy efficiency improvements.

Assumptions for future economy growth.

Information from studies and surveys on the recent situation in the energy sector.

The main advantages are related to energy, agriculture and environment problems, are foreseeable both at national and international level can be summarised as follows:

Reduction of dependence on import of energy and related products.

Reduction of environmental impact of energy production (greenhouse effect, air pollution, and waste degradation).

Substitution of food crops and reduction of food surpluses and of related economic burdens, and development of new know-how and production of technological innovation.

Utilisation of marginal lands and of set aside lands and reduction of related socio-economic and environmental problems (soil erosion, urbanisation, landscape deterioration, etc.).

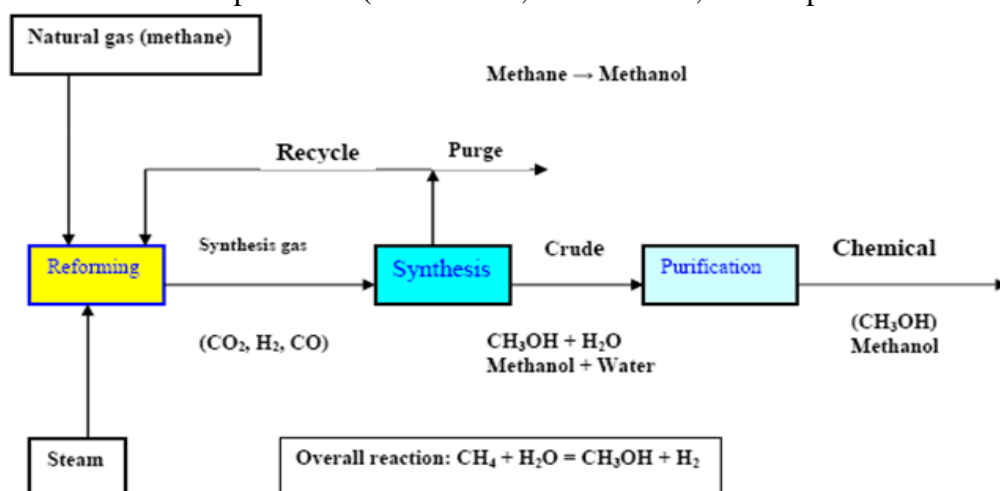

Figure 2. Schematic diagram shows methanol production [16].

In some countries, a wide range of economic incentives and other measures are already helping to protect the environment. These include:

Taxes and user charges that reflect the costs of using the environment, e.g., pollution taxes and waste disposal charges.

Subsidies, credits and grants that encourage environmental protection.

Deposit-refund systems that prevent pollution on resource misuse and promote product reuse or recycling.

Financial enforcement incentives, e.g., fines for non-compliance with environmental regulations.

Tradable permits for activities that harm the environment.

District Heating (DH), also known as community heating can be a key factor to achieve energy savings, reduce CO₂ emissions and at the same time provide consumers with a high quality heat supply at a competitive price. The DH should generally only be considered for areas where the heat density is sufficiently high to make DH economical. In countries like Denmark DH may today be economical even to new developments with lower density areas due to the high level of taxation on oil and gas fuels combined with the efficient production of the DH. To improve the opportunity for the DH local councils can adapt the following plan:

Analyse the options for heat supply during local planning stage.

In areas where DH is the least cost solution it should be made part of the infrastructure just like for instance water and sewage connecting all existing and new buildings.

Where possible all public buildings should be connected to the DH.

The government provides low interest loans or funding to minimise conversion costs for its citizens.

Use other powers, for instance national legislation to ensure the most economical development of the heat supply and enable an obligation to connect buildings to a DH scheme.

Denmark has broadly seen three scales of the CHP which were largely implemented in the following chronological order (Pernille, 2004):

Large-scale CHP in cities (>50 MWe).

Small (5 kWe – 5 MWe) and medium-scale (5-50 MWe).

Industrial and small-scale CHP.

Combined heat and power (CHP) installations are quite common in greenhouses, which grow high-energy, input crops (e.g., salad vegetables, pot plants, etc.). Most of the heat is produced by large CHP plants (gas-fired combined cycle plants using natural gas, biomass, waste or biogas). DH is energy efficient because of the way the heat is produced and the required temperature level is an important factor. Buildings can be heated to temperature of 21oC and domestic hot water (DHW) can be supplied with a temperature of 55oC using energy sources that are most efficient when producing low temperature levels (<95oC) for the DH water. Most of these heat sources are CO₂ neutral or emit low levels. Only a few of these sources are available to small individual systems at a reasonably cost, whereas DH schemes because of the plant’s size and location can have access to most of the heat sources and at a low cost. Low temperature DH, with return temperatures of around 30-40oC can utilise the following heat sources:

Efficient use of the CHP by extracting heat at low calorific value (CV).

Efficient use of biomass or gas boilers by condensing heat in economisers (Table 8).

Efficient utilisation of geothermal energy.

Direct utilisation of excess low temperature heat from industrial processes.

Efficient use of large-scale solar heating plants.

Heat tariffs may include a number of components such as a connection charge, a fixed charge and a variable energy charge. Also, consumers may be incentivised to lower the return temperature. Hence, it is difficult to generalise but the heat practice for any DH company no matter what the ownership structure can be highlighted as follows:

To develop and maintain a development plan for the connection of new consumers and to evaluate the options for least cost production of heat.

To implement the most competitive solutions by signing agreements with other companies or by implementing own investment projects.

To monitor all internal costs and with the help of benchmarking, and improve the efficiency of the company.

To maintain a good relationship with the consumer and deliver heat supply services at a sufficient quality.

Table 8. Final energy projections including biomass (Mtoe) [17]

Region 2011				
	Biomass	Conventional Energy	Total	Share of Biomass (%)
Africa	205	136	341	60
China	206	649	855	24
East Asia	106	316	422	25

Latin America	73	342	415	18
South Asia	235	188	423	56
Total developing countries	825	1632	2457	34
Other non-OECD * countries	24	1037	1061	2
Total non-OECD*	849	2669	3518	24
OECD countries	81	3044	3125	3
World	930	5713	6643	14
Region 2020				
Africa	371	266	637	59
China	224	1524	1748	13
East Asia	118	813	931	13

Table 8. (Continued)

Region 2011				
	Biomass	Conventional Energy	Total	Share of Biomass (%)
Latin America	81	706	787	10
South Asia	276	523	799	35
Total developing countries	1071	3825	4896	22
Other non-OECD * countries	26	1669	1695	2
Total non-OECD*	1097	5494	6591	17
OECD countries	96	3872	3968	2
World	1193	9365	10558	11

* Organisation for Economic Co-operation and Development

Installing DH should be pursued to meet the objectives for improving the environment through the improvement of energy efficiency in the heating sector. At the same time DH can serve the consumer with a reasonable quality of heat at the lowest possible cost. The variety of possible solutions combined with the collaboration between individual companies, the district heating association, the suppliers and consultants can, as it has been in Denmark, be the way forward for developing DH in the United Kingdom. Implementation will require initial investment, long-term national strategies and action plans. However, the changes will have a number of benefits including a more stable energy supply than at present and major improvement in the environmental performance of the energy sector, and certain social benefits (Pernille, 2004).

4. Biomass Utilisation and Development of Conversion Technologies: Sustainable energy is energy that, in its production or consumption, has minimal negative impacts on human health and the healthy functioning of vital ecological systems, including the global environment. It is an accepted fact that renewable energy is a sustainable form of energy, which has attracted more attention during recent years. A great amount of renewable energy potential, environmental interest, as well as economic consideration of fossil fuel consumption and high emphasis of sustainable development for the future will be needed. Explanations for the use of inefficient agricultural-environmental policies include: the high cost of information required to measure benefits on a site-specific basis, information asymmetries between government

agencies and farm decision makers that result in high implementation costs, distribution effects and political considerations [18]. Achieving the aim of agric-environment schemes through:
Sustain the beauty and diversity of the landscape.

Improve and extend wildlife habitats.

Conserve archaeological sites and historic features.

Improve opportunities for countryside enjoyment.

Restore neglected land or features, and

Create new habitats and landscapes.

The data required to perform the trade-off analysis simulation can be classified according to the divisions given in Table 9: the overall system or individual plants, and the existing situation or future development. The effective economic utilisations of these resources are shown in Table 10, but their use is hindered by many problems such as those related to harvesting, collection, and transportation, besides the sanitary control regulations. Biomass energy is experiencing a surge in an interest stemming from a combination of factors, e.g., greater recognition of its current role and future potential contribution as a modern fuel, global environmental benefits, its development and entrepreneurial opportunities, etc. Possible routes of biomass energy development are shown in Table 11.

The key to successful future appears to lie with successful marketing of the treatment by products. There is also potential for using solid residue in the construction industry as a filling agent for concrete. Research suggests that the composition of the residue locks metals within the material, thus preventing their escape and any subsequent negative effect on the environment [19]. The use of biomass through direct combustion has long been, and still is, the most common mode of biomass utilisation as shown in Tables (9-11). Examples for dry (thermo-chemical) conversion processes are charcoal making from wood (slow pyrolysis), gasification of forest and agricultural residues (fast pyrolysis – this is still in demonstration phase), and of course, direct combustion in stoves, furnaces, etc. Wet processes require substantial amount of water to be mixed with the biomass. Biomass technologies include:

Briquetting.

Improved stoves.

Biogas.

Improved charcoal.

Carbonisation.

Gasification.

Table 9. Classifications of data requirements [20]

Item	Plant data	System data
Existing data	Size Life Cost (fixed and var. O and M) Forced outage Maintenance Efficiency Fuel Emissions	Peak load Load shape Capital costs Fuel costs Depreciation Rate of return Taxes
Future data	All of above, plus Capital costs Construction trajectory Date in service	System lead growth Fuel price growth Fuel import limits Inflation

Table 10. Agricultural residues routes for development [20]

Source	Process	Product	End use
Agricultural residues	Direct	Combustion	Rural poor Urban household Industrial use
	Processing	Briquettes	Industrial use Limited household use
	Processing	Carbonisation (small-scale)	Rural household (self sufficiency)
	Carbonisation Fermentation	Briquettes Carbonised Biogas	Urban fuel Energy services Household Industry
Agricultural, and animal residues	Direct	Combustion	(Save or less efficiency as wood)
	Briquettes	Direct combustion	(Similar end use devices or improved)
	Carbonisation	Carbonised	Use
	Carbonisation Fermentation	Briquettes Biogas	Briquettes use Use

The increased demand for gas and petroleum, food crops, fish and large sources of vegetative matter mean that the global harvesting of carbon has in turn intensified. It could be said that mankind is mining nearly everything except its waste piles. It is simply a matter of time until the significant carbon stream present in municipal solid waste is fully captured. In the meantime, the waste industry needs to continue on the pathway to increased awareness and better-optimised biowaste resources. Optimisation of waste carbon may require widespread regulatory drivers (including strict limits on the landfilling of organic materials), public acceptance of the benefits of waste carbon products for soil improvements/crop enhancements and more investment in capital facilities [21]. In short, a significant effort will be required in order to capture a greater portion of the carbon stream and put it to beneficial use. From the standpoint of waste practitioners, further research and pilot programmes are necessary before the available carbon in the waste stream can be extracted in sufficient quality and quantities to create the desired end products. Other details need to be ironed out too, including measurement methods, diversion calculations, sequestration values and determination of acceptance contamination thresholds [22].

5.1. Briquette production

Charcoal stoves are very familiar to African society. As for the stove technology, the present charcoal stove can be used, and can be improved upon for better efficiency. This energy term will be of particular interest to both urban and rural households and all the income groups due to the simplicity, convenience, and lower air polluting characteristics. However, the market price of the fuel together with that of its end-use technology may not enhance its early high market penetration especially in the urban low income and rural households.

Table 11. Effective biomass resource utilisation [22]

Subject	Tools	Constraints
Utilisation and land clearance for agriculture expansion	Stumpage fees Control Extension Conversion Technology	Policy Fuel-wood planning Lack of extension Institutional

Utilisation of agricultural residues	Briquetting Carbonisation Carbonisation and briquetting Fermentation Gasification	Capital Pricing Policy and legislation Social acceptability
--------------------------------------	---	---

Briquetting is the formation of a charcoal (an energy-dense solid fuel source) from otherwise wasted agricultural and forestry residues. One of the disadvantages of wood fuel is that it is bulky with a low energy density and is therefore enquire to transport. Briquette formation allows for a more energy-dense fuel to be delivered, thus reducing the transportation cost and making the resource more competitive. It also adds some uniformity, which makes the fuel more compatible with systems that are sensitive to the specific fuel input [23].

5.2. Improved cook stoves

Traditional wood stoves can be classified into four types: three stone, metal cylindrical shaped, metal tripod and clay type [24]. Another area in which rural energy availability could be secured where woody fuels have become scarce, are the improvements of traditional cookers and ovens to raise the efficiency of fuel saving. Also, to provide a constant fuel supply by planting fast growing trees. The rural development is essential and economically important since it will eventually lead to better standards of living, people’s settlement, and self sufficient in the following:

Food and water supplies.

Better services in education and health care.

Good communication modes.

5.3. Biogas technology

Biogas technology cannot only provide fuel, but is also important for comprehensive utilisation of biomass forestry, animal husbandry, fishery, agricultural economy, protecting the environment, realising agricultural recycling, as well as improving the sanitary conditions, in rural areas. The introduction of biogas technology on wide scale has implications for macro planning such as the allocation of government investment and effects on the balance of payments. Factors that determine the rate of acceptance of biogas plants, such as credit facilities and technical backup services, are likely to have to be planned as part of general macro-policy, as do the allocation of research and development funds [25].

Biogas is a generic term for gases generated from the decomposition of organic material. As the material breaks down, methane (CH₄) is produced as shown in Figure 3. Sources that generate biogas are numerous and varied. These include landfill sites, wastewater treatment plants and anaerobic digesters. Landfills and wastewater treatment plants emit biogas from decaying waste. To date, the waste industry has focused on controlling these emissions to our environment and in some cases, tapping this potential source of fuel to power gas turbines, thus generating electricity. The primary components of landfill gas are methane (CH₄), carbon dioxide (CO₂), and nitrogen (N₂). The average concentration of methane is ~45%, CO₂ is ~36% and nitrogen is ~18%. Other components in the gas are oxygen (O₂), water vapour and trace amounts of a wide range of non-methane organic compounds (NMOCs).

For hot water and heating, renewables contributions come from biomass power and heat, geothermal direct heat, ground source heat pumps, and rooftop solar hot water and space heating systems. Solar assisted cooling makes a very small but growing contribution. When it comes to the installation of large amounts of the PV, the cities have several important factors in common. These factors include [25]:

A strong local political commitment to the environment and sustainability.

The presence of municipal departments or offices dedicated to the environment, and sustainability or renewable energy.

Information provision about the possibilities of renewables.

Obligations that some or all buildings include renewable energy.

5.4. Improved forest and tree management

Dry cell batteries are a practical but expensive form of mobile fuel that is used by rural people when moving around at night and for powering radios and other small appliances. The high cost of dry cell batteries is financially constraining for rural households, but their popularity gives a good indication of how valuable a versatile fuel like electricity is in rural area. Dry cell batteries can constitute an environmental hazard unless they are recycled in a proper fashion. Direct burning of fuel-wood and crop residues constitute the main usage of biomass, as is the case with many developing countries. However, the direct burning of biomass in an inefficient manner causes economic loss and adversely affects human health. In order to address the problem of inefficiency, research centres around the world have investigated the viability of converting the resource to a more useful form, namely solid briquettes and fuel gas (Figure 4). Biomass resources play a significant role in energy supply in all developing countries. Biomass resources should be divided into residues or dedicated resources, the latter including firewood and charcoal can also be produced from forest residues (Table 12).

Implementing measures for energy efficiency increase at the demand side and in the energy transformation sector is important. It is common practice to dispose of this waste wood in landfill where it slowly degraded and takes up valuable void space. This wood is a good source of energy and is an alternative to energy crops. Agricultural wastes are abundantly available globally and can be converted to energy and useful chemicals by a number of microorganisms. The success of promoting any technology depends on careful planning, management, implementation, training and monitoring. Main features of gasification project are:

Networking and institutional development/strengthening.

Promotion and extension.

Construction of demonstration projects.

Research and development, and training and monitoring.

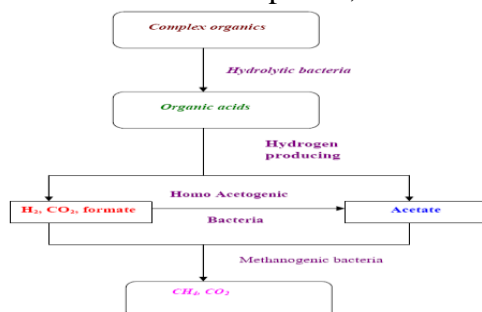

Figure 3. Biogas production process [26].

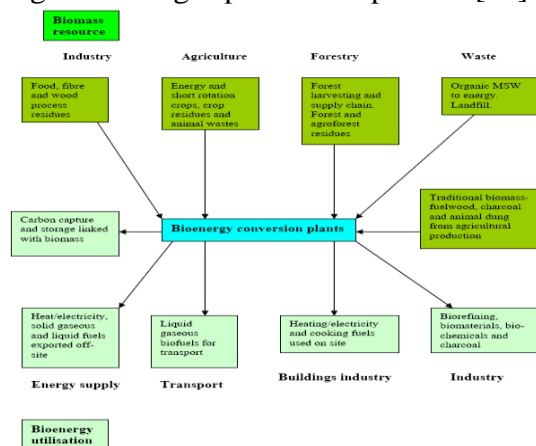

Figure 4. Biomass resources from several sources are converted into a range of products for use by transport, industry and building sectors [27].

5.5. Gasification processes

Gasification is based on the formation of a fuel gas (mostly CO and H₂) by partially oxidising raw solid fuel at high temperatures in the presence of steam or air. The technology can use wood chips, groundnut shells, sugar cane bagasse, and other similar fuels to generate capacities from 3 kW to 100 kW. Three types of gasifier designs have been developed to make use of the diversity of fuel inputs and to meet the requirements of the product gas output (degree of cleanliness, composition, heating value, etc.). The requirements of gas for various purposes, and a comparison between biogas and various commercial fuels in terms of calorific value, and thermal efficiency are presented in Table 13. Sewage sludge is rich in nutrients such as nitrogen and phosphorous. It also contains valuable organic matter, useful for remediation of depleted or eroded soils. This is why untreated sludge has been used for many years as a soil fertiliser and for enhancing the organic matter of soil. A key concern is that treatment of sludge tends to concentrate heavy metals, poorly biodegradable trace organic compounds and potentially pathogenic organisms (viruses, bacteria and the like) present in wastewaters. These materials can pose a serious threat to the environment. When deposited in soils, heavy metals are passed through the food chain, first entering crops, and then animals that feed on the crops and eventually human beings, to whom they appear to be highly toxic. In addition they also leach from soils, getting into groundwater and further spreading contamination in an uncontrolled manner [28].

Table 12. Biomass residues and current use [28]

Type of residue	Current use
Wood industry waste	Residues available
Vegetable crop residues	Animal feed
Food processing residue	Energy needs
Sorghum, millet, and wheat residues	Fodder, and building materials
Groundnut shells	Fodder, brick making, and direct fining oil mills
Cotton stalks	Domestic fuel considerable amounts available for short period
Sugar, bagasse, and molasses	Fodder, energy need, and ethanol production (surplus available)
Manure	Fertiliser, brick making, and plastering

European and American markets aiming to transform various organic wastes (animal farm wastes, industrial and municipal wastes) into two main by-products:

A solution of humic substances (a liquid oxidate).

A solid residue.

Agricultural wastes are abundantly available globally and can be converted to energy and useful chemicals by a number of microorganisms. The organic matter was biodegradable to produce biogas and the variation show a normal methanogene bacteria activity and good working biological process as shown in Figures 5-7. The success of promoting any technology depends on careful planning, management, implementation, training and monitoring. Main features of gasification project are:

Networking and institutional development/strengthening.

Promotion and extension.

Construction of demonstration projects.

Research and development, and training and monitoring.

Biomass is a raw material that has been utilised for a wide variety of tasks since the dawn of civilisation. Important as a supply of fuel in the third world, biomass was also the first raw material in the production of textiles. The gasification of the carbon char with steam can make a large difference to the surface area of the carbon. The corresponding steam gasification

reactions are endothermic and demonstrate how the steam reacts with the carbon charcoal (Bacaoui, 1998).

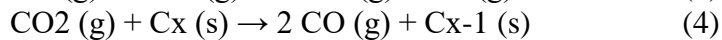
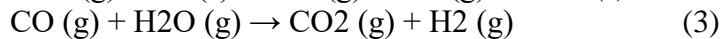

Table 13. Comparison of various fuels [28]

Fuel	Calorific value (kcal)	Burning mode	Thermal efficiency (%)
Electricity, kWh	880	Hot plate	70
Coal gas, kg	4004	Standard burner	60
Biogas, m ³	5373	Standard burner	60
Kerosene, l	9122	Pressure stove	50
Charcoal, kg	6930	Open stove	28
Soft coke, kg	6292	Open stove	28
Firewood, kg	3821	Open stove	17
Cow dung, kg	2092	Open stove	11

The sources to alleviate the energy situation in the world are sufficient to supply all foreseeable needs. Conservation of energy and rationing in some form will however have to be practised by most countries, to reduce oil imports and redress balance of payments positions. Meanwhile development and application of nuclear power and some of the traditional solar, wind and water energy alternatives must be set in hand to supplement what remains of the fossil fuels.

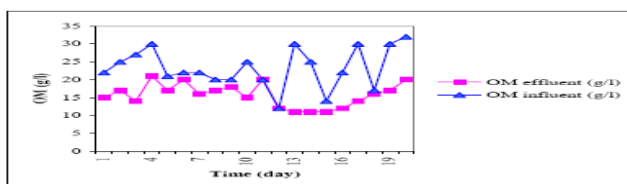

Figure 5. Organic matters before and after treatment in digester [29].

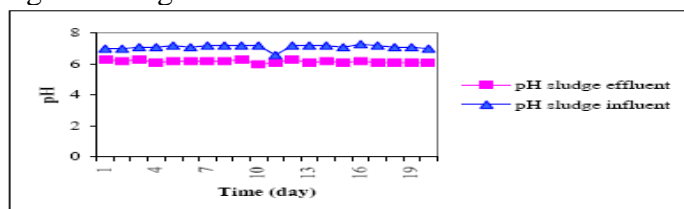

Figure 6. Potential of hydrogen (pH) sludge before and after treatment in the digester [29].

The encouragement of greater energy use is an essential component of development. In the short-term it requires mechanisms to enable the rapid increase in energy/capita, and in the long-term we should be working towards a way of life, which makes use of energy efficiency and without the impairment of the environment or of causing safety problems. Such a programme should as far as possible be based on renewable energy resources.

Table 14. Biomass conversions to energy [29]

Feedstock	Crops	Conversion process	End product
Wood-cellulosic biomass	Short rotation forest (poplar, willow), plant species (sorghum, miscanthus, etc.), fibre-crops (cynara, kenaf, etc.)	Direct combustion	Heat
		Gasification	Methane
		Pyrolysis	Hydrogen
Vegetable oils	Oleaginous crops (rapeseed, soybean, sunflower, etc.)	Direct combustion	Oil
		Esterification	Biodiesel

Sugar/starch	Cereals, root and tuber crops, grape, topinambour, etc.	Fermentation	Ethanol
--------------	---	--------------	---------

6. Bioheat

Bioenergy is a growing source of power that is playing an ever-increasing role in the provision of electricity. The potential contribution of the waste industry to bioenergy is huge and has the ability to account for a source of large amount of total bioenergy production. Woody biomass is usually converted into power through combustion or gasification. Biomass can be specially grown in the case of energy crops. Waste wood makes up a significant proportion of a variety of municipal, commercial and industrial waste streams. It is common practice to dispose of this waste wood in landfill where it slowly degraded and takes up valuable void space. This wood is a good source of energy and is an alternative to energy crops. The biomass directly produced by cultivation can be transformed by different processes into gaseous, liquid or solid fuels (Table 14). The whole process of production of methyl or ethyl esters (biodiesel) is summarised in Figures 8-9.

In Figure 7 Advanced biomass power with diesel engine at equilibrium, the rate at which vapour is formed (determined by Q_1) equals the rate at which it is removed. Therefore, both the heat transfer rate into the liquid (Q_2) and the vapour removal rate (suction pump capacity) determines the pressure cooling capacity, i.e., Q_3 ; Q_4 Capacity (thermal power) (Watt); External heat input i.e., W_1 ; W_2 Heat (thermal energy) (J),

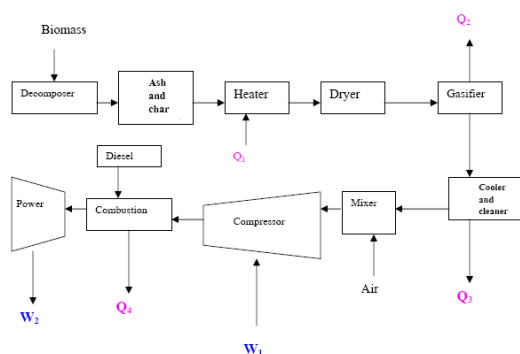

Figure 7. Advanced biomass power with diesel engine [30].

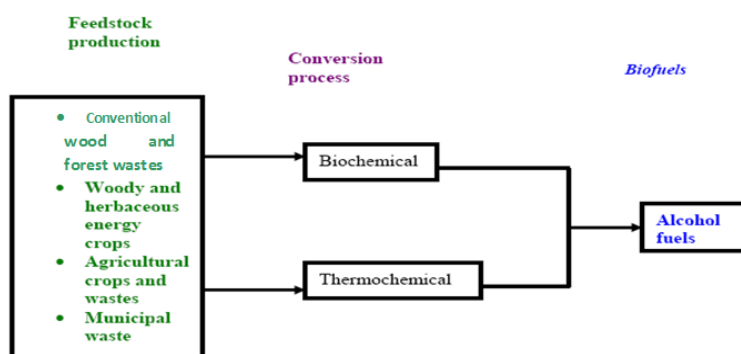

Figure 8. Biofuel pathways for renewable alcohol fuels [30].

6.1. Waste policy in context

In terms of solid waste management policy, many non-governmental organisations (NGOs) have changed drastically in the past ten years from a mass production and mass consumption society to ‘material-cycle society’. In addition to national legislation, municipalities are legally obliged to develop a plan for handling the municipal solid waste (MSW) generated in administrative areas. Such plans contain:

Estimates of future waste volume.

Measures to reduce waste.

Measures to encourage source separation.

A framework for solid waste disposal and the construction and management of solid waste management facilities.

Landfilling is in the least referred tier of the hierarchy of waste management options: waste minimisation, reuse and recycling, incineration with energy recovery, and optimised final disposal. The key elements are as follows: construction impacts, atmospheric emissions, noise, water quality, landscape, visual impacts, socio economics, ecological impacts, traffic, solid waste disposal and cultural heritage [31].

6.2. Energy from agricultural biomass

The main advantages are related to energy, agriculture and environment problems, are foreseeable both at regional level and at worldwide level and can be summarised as follows:

Reduction of dependence on import of energy and related products.

Reduction of environmental impact of energy production (greenhouse effect, air pollution, and waste degradation).

Substitution of food crops and reduction of food surpluses and of related economic burdens.

Utilisation of marginal lands and of set aside lands and reduction of related socio-economic and environmental problems (soil erosion, urbanisation, landscape deterioration, etc.).

Development of new know-how and production of technological innovation.

A study (Bacaoui, 1998) individuated on the basis of botanical, genetical, physiological, biochemical, agronomical and technological knowledge reported in literature some 150 species potentially exploitable divided as reported in Table 15.

7. Role of Chemical Engineering

Turning to chemical engineering and the experience of the chemical process industry represents a wakening up but does not lead to an immediate solution to the problems. The traditional techniques are not very kind to biological products, which are controlled by difficulty and unique physico-chemical properties such as low mechanical, thermal and chemical stabilities. There is the question of selectivity.

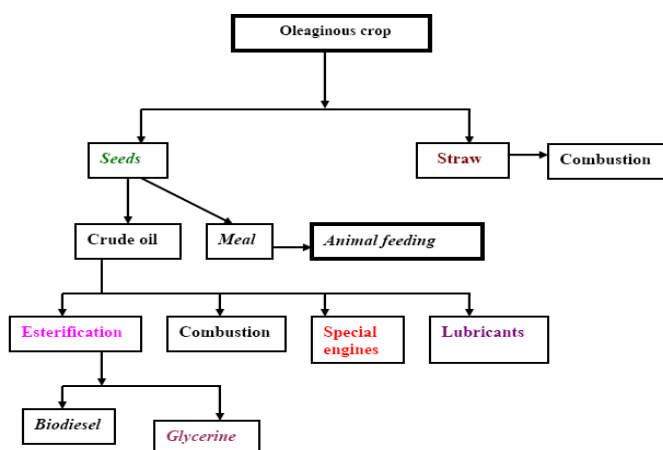

Figure 9. Flow chart of biodiesel production [32].

Table 15. Plant species potentially exploitable for production of agricultural biomass for energy or industrial utilisations [32]

Groups of plants	Number of species
Plants cultivated for food purposes that can be reconverted to new uses	9
Plants cultivated in the past, but not in culture any more	46
Plants cultivated in other world areas	46

Wild species, both indigenous and exotic	47
Total	148
Plant product	Number of species
Biomass	8
Sugars and polysaccharides	38
Cellulose	17
Hydrocarbons	3
Polymeric hydrocarbons	5
Gums and resins	12
Tannins and phenolic compounds	3
Waxes	7
Vegetable oils	38
Total	131

The fermentation broths resulting from microbial growth contain a bewildering mixture of many compounds closely related to the product of interests. By the standards of the process streams in chemical industry, fermenter is highly impure and extremely dilutes aqueous systems (Table 16).

Table 16. Typical product concentrations exiting fermenters [32]

Product	Concentration (kg/m ³)
Ethanol	70-120
Organic acids (e.g., citric)	40-100
Vitamin B12	0.02
Interferon	50-70
Single-cell protein	30-50
Antibiotics (e.g., Penicillin G)	10-30
Enzyme protein (e.g., protease)	2-5

The disadvantages of the fermentation media are as the following: mechanically fragile, temperature sensitive, rapidly deteriorating quality, harmful if escaping into the environment, corrosive (acids, chlorides, etc.), and troublesome (solids, theological, etc.), and expensive. Thus, pilot plants for scale-up work must be flexible. In general, they should contain suitably interconnected equipment for: fermentation, primary separation, cell disruption fractionalises and clarifications, purification by means of high-resolution techniques and concentration and dry. The effects of the chlorofluorocarbons (CFCs) molecule can last for over a century.

7.1. Fluidised bed drying

An important consideration for operators of wastewater treatment plants is how to handle the disposal of the residual sludge in a reliable, sustainable, legal and economical way. The benefits of drying sludge can be seen in two main treatment options:

Use of the dewatered sludge as a fertiliser or in fertiliser blends.

Incineration with energy recovery.

Use as a fertiliser takes advantage of the high organic content 40%-70% of the dewatered sludge and its high levels of phosphorous and other nutrients. However, there are a number of concerns about this route including:

The chemical composition of the sludge (e.g., heavy metals, hormones and other pharmaceutical residues).

Pathogen risk (e.g., SALMOELLA, ESCHERICHIA COLI, prionic proteins, etc.).

Potential accumulation of heavy metals and other chemicals in the soil.

Sludge can be applied as a fertiliser in three forms: liquid sludge, wet cake blended into compost, and dried granules.

The advantages of energy recovery sludge include:

The use of dewatered sludge is a ‘sink’ for pollutants such as heavy metals, toxic organic compounds and pharmaceutical residues. Thus, offering a potential disposal route for these substances provided the combustion plant has adequate flue gas cleaning.

The potential, under certain circumstances, to utilise the inorganic residue from sludge incineration (incinerator ash), such as in cement or gravel.

The high calorific value (similar to lignite) of dewatered sludge.

The use of dewatered sludge as a carbon dioxide neutral substitute for primary fuels such as oil, gas and coal.

7.2. Energy efficiency

Energy efficiency is the most cost-effective way of cutting carbon dioxide emissions and improvements to households and businesses. It can also have many other additional social, economic and health benefits, such as warmer and healthier homes, lower fuel bills and company running costs and, indirectly, jobs. Britain wastes 20 per cent of its fossil fuel and electricity use in transportation (Omer, 2006). This implies that it would be cost-effective to cut £10 billion a year off the collective fuel bill and reduce CO₂ emissions by some 120 million tonnes CO₂ [33]. Yet, due to lack of good information and advice on energy saving, along with the capital to finance energy efficiency improvements, this huge potential for reducing energy demand is not being realised. Traditionally, energy utilities have been essentially fuel providers and the industry has pursued profits from increased volume of sales. Institutional and market arrangements have favoured energy consumption rather than conservation. However, energy is at the centre of the sustainable development paradigm as few activities affect the environment as much as the continually increasing use of energy. Most of the used energy depends on finite resources, such as coal, oil, gas and uranium. In addition, more than three quarters of the world’s consumption of these fuels is used, often inefficiently, by only one quarter of the world’s population. Without even addressing these inequities or the precious, finite nature of these resources, the scale of environmental damage will force the reduction of the usage of these fuels long before they run out.

Throughout the energy generation process there are impacts on the environment on local, national and international levels, from opencast mining and oil exploration to emissions of the potent greenhouse gas carbon dioxide in ever increasing concentration. Recently, the world’s leading climate scientists reached an agreement that human activities, such as burning fossil fuels for energy and transport, are causing the world’s temperature to rise. The Intergovernmental Panel on Climate Change has concluded that “the balance of evidence suggests a discernible human influence on global climate”. It predicts a rate of warming greater than any one seen in the last 10,000 years, in other words, throughout human history. The exact impact of climate change is difficult to predict and will vary regionally. It could, however, include sea level rise, disrupted agriculture and food supplies and the possibility of more freak weather events such as hurricanes and droughts. Indeed, people already are waking up to the financial and social, as well as the environmental, risks of unsustainable energy generation methods that represent the costs of the impacts of climate change, acid rain and oil spills. The insurance industry, for example, concerned about the billion dollar costs of hurricanes and floods, has joined sides with environmentalists to lobby for greenhouse gas emissions reduction. Friends of the earth are campaigning for a more sustainable energy policy, guided by the principal of environmental protection and with the objectives of sound natural resource management and long-term energy security. The key priorities of such an energy policy must be to reduce fossil fuel use, move away from nuclear power, improve the efficiency with which energy is used and increase the amount of energy obtainable from sustainable and renewable sources. Efficient energy use has never been more crucial than it is today, particularly with the prospect of the imminent introduction of the climate change levy (CCL). Establishing an

energy use action plan is the essential foundation to the elimination of energy waste. A logical starting point is to carry out an energy audit that enables the assessment of the energy use and determine what actions to take. The actions are best categorised by splitting measures into the following three general groups:

(1) High priority/low cost:

These are normally measures, which require minimal investment and can be implemented quickly. The followings are some examples of such measures:

Good housekeeping, monitoring energy use and targeting waste-fuel practices.

Adjusting controls to match requirements.

Improved greenhouse space utilisation.

Small capital item time switches, thermostats, etc.

Carrying out minor maintenance and repairs.

Staff education and training.

Ensuring that energy is being purchased through the most suitable tariff or contract arrangements.

(2) Medium priority/medium cost:

Measures, which, although involve little or no design, involve greater expenditure and can take longer to implement. Examples of such measures are listed below:

New or replacement controls.

Greenhouse component alteration, e.g., insulation, sealing glass joints, etc.

Alternative equipment components, e.g., energy efficient lamps in light fittings, etc.

(3) Long term/high cost:

These measures require detailed study and design. They can be best represented by the followings:

Replacing or upgrading of plant and equipment.

Fundamental redesign of systems, e.g., CHP installations.

This process can often be a complex experience and therefore the most cost-effective approach is to employ an energy specialist to help.

7.3. Future recommended sustainable energy policy

Sustainability is regarded as a major consideration for both urban and rural development. People have been exploiting the natural resources with no consideration to the effects, both short-term (environmental) and long-term (resources crunch). It is also felt that knowledge and technology have not been used effectively in utilising energy resources. Energy is the vital input for economic and social development of any country. Its sustainability is an important factor to be considered. The urban areas depend, to a large extent, on commercial energy sources. The rural areas use non-commercial sources like firewood and agricultural wastes. With the present day trends for improving the quality of life and sustenance of mankind, environmental issues are considered highly important. In this context, the term energy loss has no significant technical meaning. Instead, the exergy loss has to be considered, as destruction of exergy is possible. Hence, exergy loss minimisation will help in sustainability. In the process of developing, there are two options to manage energy resources: (1) End use matching/demand side management, which focuses on the utilities. The mode of obtaining this is decided based on economic terms. It is, therefore, a quantitative approach. (2) Supply side management, which focuses on the renewable energy resource and methods of utilising it. This is decided based on thermodynamic consideration having the resource-user temperature or exergy destruction as the objective criteria. It is, therefore, a qualitative approach. The two options are explained schematically in Figure 10. The exergy-based energy, developed with supply side perspective is shown in Figure 11. The following policy measures had been identified:

Clear environmental and social objectives for energy market liberalisation, including a commitment to energy efficiency and renewables.

Economic, institutional and regulatory frameworks, which encourage the transition to total energy services.

Economic measures to encourage utility investment in energy efficiency (e.g., levies on fuel bills).

Incentives for demand side management, including grants for low-income households, expert advice and training, standards for appliances and buildings and tax incentives.

Research and development funding for renewable energy technologies not yet commercially viable.

Continued institutional support for new renewables (such as standard cost-reflective payments and obligation on utilities to buy).

Ecological tax reform to internalise external environmental and social costs within energy prices.

Planning for sensitive development and public acceptability for renewable energy.

Energy resources are needed for societal development. Their sustainable development requires a supply of energy resources that are sustainably available at a reasonable cost and can cause no negative societal impacts. Energy resources such as fossil fuels are finite and lack sustainability, while renewable energy sources are sustainable over a relatively longer term. Environmental concerns are also a major factor in sustainable development, as activities, which degrade the environment, are not sustainable. Hence, as much as environmental impact is associated with energy, sustainable development requires the use of energy resources, which cause as little environmental impact as possible. One way to reduce the resource depletion associated with cycling is to reduce the losses that accompany the transfer of exergy to consume resources by increasing the efficiency of exergy transfer between resources, i.e., increasing the fraction of exergy removed from one resource that is transferred to another [34].

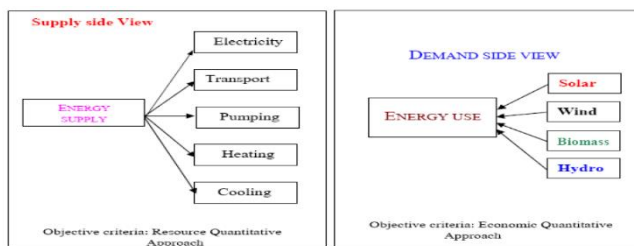

Figure 10. Supply side and demand side management approach for energy [34].

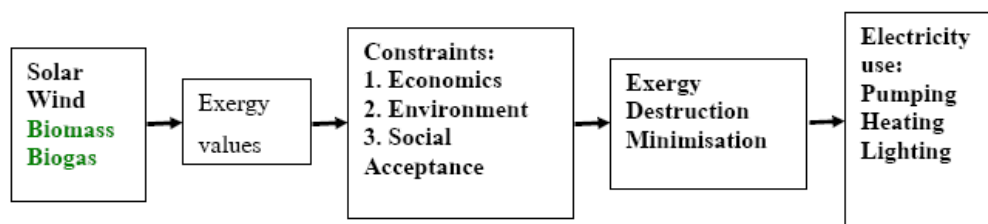

Figure 11. Exergy based optimal energy model [34].

As explained above, exergy efficiency may be thought of as a more accurate measure of energy efficiency that accounts for quantity and quality aspects of energy flows. Improved exergy efficiency leads to reduced exergy losses. Most efficiency improvements produce direct environmental benefits in two ways. First, operating energy input requirements are reduced per unit output, and pollutants generated are correspondingly reduced. Second, consideration of the entire life cycle for energy resources and technologies suggests that improved efficiency reduces environmental impact during most stages of the life cycle. Quite often, the main concept of sustainability, which often inspires local and national authorities to incorporate environmental consideration into setting up energy programmes have different meanings in

different contexts though it usually embodies a long-term perspective. Future energy systems will largely be shaped by broad and powerful trends that have their roots in basic human needs. Combined with increasing world population, the need will become more apparent for successful implementation of sustainable development [35].

Heat has a lower exergy, or quality of energy, compared with work. Therefore, heat cannot be converted into work by 100% efficiency. Some examples of the difference between energy and exergy are shown in Table 17.

$$\text{Carnot Quality Factor (CQF)} = (1 - T_o / T_s) \quad (5)$$

$$\text{Exergy} = \text{Energy (transferred)} \times \text{CQF} \quad (6)$$

Where T_o is the environment temperature (K) and T_s is the temperature of the stream (K).

Table 17. Qualities of various energy sources [35]

Source	Energy (J)	Exergy (J)	CQF
Water at 80oC	100	16	0.16
Steam at 120oC	100	24	0.24
Natural gas	100	99	0.99
Electricity/work	100	100	1.00

The terms used in Table 17 have the following meanings:

Various parameters are essential to achieving sustainable development in a society. Some of them are as follows:

Public awareness.

Information.

Environmental education and training.

Innovative energy strategies.

Renewable energy sources and cleaner technologies.

Financing.

Monitoring and evaluation tools.

Improving access for rural and urban low-income areas in developing countries must be through energy efficiency and renewable energies. Sustainable energy is a prerequisite for development. Energy-based living standards in developing countries, however, are clearly below standards in developed countries. Low levels of access to affordable and environmentally sound energy in both rural and urban low-income areas are therefore a predominant issue in developing countries. In recent years many programmes for development aid or technical assistance have been focusing on improving access to sustainable energy, many of them with impressive results [36].

Apart from success stories, however, experience also shows that positive appraisals of many projects evaporate after completion and vanishing of the implementation expert team. Altogether, the diffusion of sustainable technologies such as energy efficiency and renewable energies for cooking, heating, lighting, electrical appliances and building insulation in developing countries has been slow. Energy efficiency and renewable energy programmes could be more sustainable and pilot studies more effective and pulse releasing if the entire policy and implementation process was considered and redesigned from the outset. New financing and implementation processes are needed which allow reallocating financial resources and thus enabling countries themselves to achieve a sustainable energy infrastructure. The links between the energy policy framework, financing and implementation of renewable energy and energy efficiency projects have to be strengthened and capacity building efforts are required.

Results and Discussions

The presented study is general review on the potential and use of bioenergy. It highlights some assets and disadvantages of this type of energy source focusing on sustainability aspects [37-38]. Also, the following action areas for producers were recommended:

Management and measurement tools- adopting environmental management systems appropriate for the business.

Performance assessment tools- making use of benchmarking to identify scope for impact reduction and greater eco-efficiency in all aspects of the business.

Best practice tools- making use of free help and advice from government best practice programmes (energy efficiency, environmental technology, and resource savings).

Innovation and ecodesign- rethinking the delivery of ‘value added’ by the business, so that impact reduction and resource efficiency are firmly built in at the design stage.

Cleaner, leaner production processes- pursuing improvements and savings in waste minimisation, energy and water consumption, transport and distribution, as well as reduced emissions.

Supply chain management- specifying more demanding standards of sustainability from ‘upstream’ suppliers, while supporting smaller firms to meet those higher standards.

Product stewardship- taking the broadest view of ‘producer responsibility’ and working to reduce all the ‘downstream’ effects of products after they have been sold on to customers.

Openness and transparency- publicly reporting on environmental performance against meaningful targets; actively using clear labels and declarations so that customers are fully informed; building stakeholder confidence by communicating sustainability aims to the workforce, the shareholders and the local community (Figure 12).

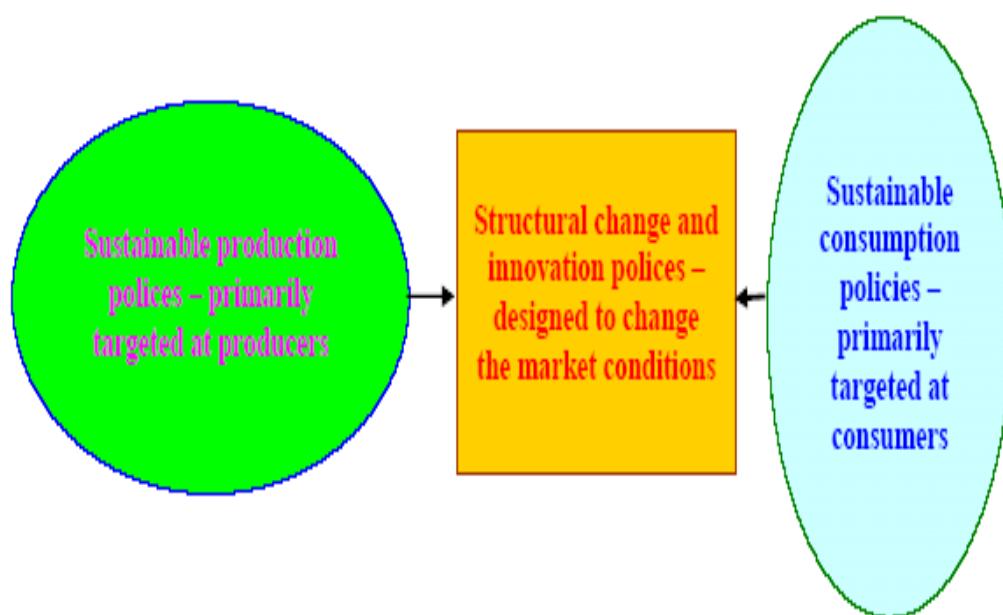

Figure 12. Link between resources and productivity [39].

Table 18. The basket of indicators for sustainable consumption and production [39]

<p>Economy-wide decoupling indicators</p> <ol style="list-style-type: none"> 1. Greenhouse gas emissions 2. Air pollution 3. Water pollution (river water quality) 4. Commercial and industrial waste arisings and household waste not cycled <p>Resource use indicators</p> <ol style="list-style-type: none"> 5. Material use 6. Water abstraction
--

7. Homes built on land not previously developed, and number of households

Decoupling indicators for specific sectors

8. Emissions from electricity generation

9. Motor vehicle kilometres and related emissions

10. Agricultural output, fertiliser use, methane emissions and farmland bird populations

11. Manufacturing output, energy consumption and related emissions

12. Household consumption, expenditure energy, water consumption and waste generated

Alternatively energy sources can potentially help fulfill the acute energy demand and sustain economic growth in many regions of the world. Bioenergy is beginning to gain importance in the global fight to prevent climate change. The scope for exploiting organic waste as a source of energy is not limited to direct incineration or burning refuse-derived fuels. Biogas, biofuels and woody biomass are other forms of energy sources that can be derived from organic waste materials. These biomass energy sources have significant potential in the fight against climate change. Recently, there are many studies on modern biomass energy technology systems published [40].

This is the step in a long journey to encourage a progressive economy, which continues to provide people with high living standards, but at the same time helps reduce pollution, waste mountains, other environmental degradation, and environmental rationale for future policy-making and intervention to improve market mechanisms. This vision will be accomplished by: ‘Decoupling’ economic growth and environmental degradation. The basket of indicators illustrated shows the progress being made (Table 18). Decoupling air and water pollution from growth, making good headway with CO₂ emissions from energy, and transport. The environmental impact of our own individual behaviour is more closely linked to consumption expenditure than the economy as a whole.

Focusing policy on the most important environmental impacts associated with the use of particular resources, rather than on the total level of all resource use.

Increasing the productivity of material and energy use that are economically efficient by encouraging patterns of supply and demand, which are more efficient in the use of natural resources. The aim is to promote innovation and competitiveness. Investment in areas like energy efficiency, water efficiency and waste minimisation.

Encouraging and enabling active and informed individual and corporate consumers.

Vegetation and in particular forests, can be managed to sequester carbon. Management options have been identified to conserve and sequester up to 90 Pg C in the forest sector in the next century, through global afforestation [41]. For efficient use of bioenergy resources, it is essential to take account of the intrinsic energy potential. Despite the availability of basic statistics, many differences have been observed between the previous assessments of bioenergy potential [41].

On some climate change issues (such as global warming), there is no disagreement among the scientists. The greenhouse effect is unquestionably real; it is essential for life on earth. Water vapour is the most important GHG; followed by carbon dioxide (CO₂). Without a natural greenhouse effect, scientists estimate that the earth’s average temperature would be –18oC instead of its present 14oC [41]. There is also no scientific debate over the fact that human activity has increased the concentration of the GHGs in the atmosphere (especially CO₂ from combustion of coal, oil and gas). The greenhouse effect is also being amplified by increased concentrations of other gases, such as methane, nitrous oxide, and CFCs as a result of human emissions. Most scientists predict that rising global temperatures will raise the sea level and increase the frequency of intense rain or snowstorms (Andrea, and Fernando, 2012).

Globally, buildings are responsible for approximately 40% of the total world annual energy consumption. Most of this energy is for the provision of lighting, heating, cooling, and air conditioning. Increasing awareness of the environmental impact of CO₂, NO_x and CFCs emissions triggered a renewed interest in environmentally friendly cooling, and heating technologies. Under the 1997 Montreal Protocol, governments agreed to phase out chemicals used as refrigerants that have the potential to destroy stratospheric ozone. It was therefore considered desirable to reduce energy consumption and decrease the rate of depletion of world energy reserves and pollution of the environment. One way of reducing building energy consumption is to design buildings, which are more economical in their use of energy for heating, lighting, cooling, ventilation and hot water supply. Passive measures, particularly natural or hybrid ventilation rather than air-conditioning, can dramatically reduce primary energy consumption. However, exploitation of renewable energy in buildings and agricultural greenhouses can, also, significantly contribute towards reducing dependency on fossil fuels. Therefore, promoting innovative renewable applications and reinforcing the renewable energy market will contribute to preservation of the ecosystem by reducing emissions at local and global levels [42].

The adoption of green or sustainable approaches to the way in which society is run is seen as an important strategy in finding a solution to the energy problem. The key factors to reducing and controlling CO₂, which is the major contributor to global warming, are the use of alternative approaches to energy generation and the exploration of how these alternatives are used today and may be used in the future as green energy sources. Even with modest assumptions about the availability of land, comprehensive fuel-wood farming programmes offer significant energy, economic and environmental benefits. These benefits would be dispersed in rural areas where they are greatly needed and can serve as linkages for further rural economic development. The nations as a whole would benefit from savings in foreign exchange, improved energy security, and socio-economic improvements. With a nine-fold increase in forest – plantation cover, a nation’s resource base would be greatly improved. The international community would benefit from pollution reduction, climate mitigation, and the increased trading opportunities that arise from new income sources.

Conclusion

Even with modest assumptions about the availability of land, comprehensive fuel-wood farming programmes offer significant energy, economic and environmental benefits. These benefits would be dispersed in rural areas where they are greatly needed and can serve as linkages for further rural economic development. The nations, as a whole would benefit from savings in foreign exchange, improved energy security, and socio-economic improvements. With a nine-fold increase in forest – plantation cover, the nation’s resource base would be greatly improved. The international community would benefit from pollution reduction, climate mitigation, and the increased trading opportunities that arise from new income sources. Furthermore, investigating the potential is needed to make use of more and more of its waste. Household waste, vegetable market waste, and waste from the cotton stalks, leather, and pulp; and paper industries can be used to produce useful energy either by direct incineration, gasification, digestion (biogas production), fermentation, or cogeneration. Therefore, effort has to be made to reduce fossil energy use and to promote green energies, particularly in the building sector. Energy use reductions can be achieved by minimising the energy demand, by rational energy use, by recovering heat and the use of more green energies. This study was a step towards achieving that goal.

Acknowledgments

The financial support for this research work from the Energy Research Institute is gratefully acknowledged. I am grateful to my wife Kawthar Abdelhai Ali for standing beside me.

References

- [1] Abdeen M. O. (2015). Utilisation of biomass for renewable bioenergy development, *International Journal of Comprehensive Research in Biological Science*, Vol.2, No.1, p. 1-28, India, January 2015.
- [2] Abdeen, M. O. (2008a). Renewable building energy systems and passive human comfort solutions. *Renewable and Sustainable Energy Reviews*, 12(6), 1562-1587.
- [2] Abdeen, M. O. (2008b). People, power and pollution. *Renewable and Sustainable Energy Reviews*, 12(7), 1864-1889.
- [4] Abdeen, M. O. (2008c). Energy, environment and sustainable development. *Renewable and Sustainable Energy Reviews*, 12(9), 2265-2300.
- [5] Abdeen, M. O. (2008d). Focus on low carbon technologies: The positive solution. *Renewable and Sustainable Energy Reviews*, 12(9), 2331-2357.
- [6] Abdeen, M. O. (2008e). Chapter 10: Development of integrated bioenergy for improvement of quality of life of poor people in developing countries. In F. L. Magnusson & O. W. Bengtsson (Eds.), *Energy in Europe: Economics, policy and strategy* (pp. 341-373). New York, NY: NOVA Science Publishers.
- [7] Abdeen, M. O. (2009a). Environmental and socio-economic aspect of possible development in renewable energy use. In *Proceedings of the 4th International Symposium on Environment*, Athens, Greece, 21-24 May 2009.
- [8] Abdeen, M. O. (2009b). Energy use, environment and sustainable development. In *Proceedings of the 3rd International Conference on Sustainable Energy and Environmental Protection (SEEP 2009)*, Paper No.1011, Dublin, Republic of Ireland, 12-15 August 2009.
- [9] Abdeen, M. O. (2009c). Energy use and environmental: Impacts: A general review. *Journal of Renewable and Sustainable Energy*, 1(5), 1-29.
- [10] Abdeen, M. O. (2009d). Chapter 3: Energy use, environment and sustainable development. In R. T. Mancuso (Ed.), *Environmental cost management*, (pp. 129-166). New York, NY: NOVA Science Publishers.
- [11] Aladjadjian, A., and Kakanakov, R. (2008). The role of RES in future power supply of Bulgaria. 7th Balkan Power Conference, Sibenik, Croatia, 10-12 September 2008, *Proceedings*, ISBN 987-243-091-7, Published by University of Ljubljana, Ed. Andrej Gubina.
- [12] Aladjadjian, A., Kakanakov, R. and Zahariev, A. (2010). Biomass energy resources in estimation and sustainable incorporation of biomass and other RES in municipal and national strategies for energy development, *Scopie*, 4.10.2010. *Proceedings*, pp 88-95.
- [13] Aleksandar Z., Dimo, P., Anna, A. (2014). Biogas from animal manure-perspectives and barriers in Bulgaria, *Annual Research and Review in Biology*, 4(5): 709-719.
- [14] Andrea, S., and Fernando, R. (2012). Identifying, developing, and moving sustainable communities through renewable energy, *World Journal of Science, Technology and Sustainable Development*, 9(4): 273-281.
- [15] Aroyeun, S. O. (2009). Reduction of aflatoxin B1 and Ochratoxin A in cocoa beans infected with *Aspergillus* via Ergosterol Value. *World Review of Science, Technology and Sustainable Development*, 6(1), 75-90.
- [16] Bacaoui, A., Yaacoubi, A., Dahbi, C., Bennouna, J., and Mazet, A. (1998). Activated carbon production from Moroccan olive wastes-influence of some factors. *Environmental Technology* 19: 1203-1212.
- [17] Barton A. L. (2007). *Focus on sustainable development research advances*, (pp. 189-205). New York, NY: NOVA Science Publishers, Inc.
- [18] Bessou, S. (2009). Biofuels, greenhouse gases and climate change. *Agronomy for Sustainable Development*, DOI: 10. 1051/agro/2009039.

- [19] Bhutto A, Bazmi A, Zahwidi G (2011) Greener energy: issues and challenges for Pakistan – Biomass energy prospective. *Renewable and Sustainable Energy Reviews*, 15 (6): 3207-3219.
- [20] Brain, G., & Mark, S. (2007). Garbage in, energy out: Landfill gas opportunities for CHP projects. *Cogeneration and On-Site Power*, 8(5), 37-45.
- [21] Cheng, R. (2010). Advanced biofuel technologies: status and barriers. World Bank Report, WPS5411.
- [22] Cihan G, Dursun B, Bora A, Erkan S (2009) Importance of biomass energy as alternative to other sources in Turkey. *Energy Policy*, 37 (2): 424-431.
- [23] D’Apote, S.L. (1998). IEA biomass energy analysis and projections. In: *Proceedings of Biomass Energy Conference: Data, analysis and Trends*, Paris: OECD; 23-24 March 1998.
- [24] Duku, B. (2009). Comprehensive review of biomass resources and biofuels potential in Ghana. *Renewable and Sustainable Energy Review*, 15: 404-415.
- [25] Erlich, P. (1991). Forward facing up to climate change, in *Global Climate Change and Life on Earth*. R.C. Wyman (Ed), Chapman and Hall, London.
- [26] Hall O. and Scrase J. (1998). Will biomass be the environmentally friendly fuel of the future? *Biomass and Bioenergy* 15: 357-67.
- [27] Jeremy, L. (2005). The energy crisis, global warming and the role of renewables. *Renewable Energy World*, 8(2).
- [28] Kothari, D. P., Singal, K. C., Rakesh, Ranjan (2011). *Renewable energy sources and emerging technologies*, 2nd Edition, Private Ltd, New Delhi, 2011.
- [29] Lattimore, B. (2009). Environmental factors in woodfuel production- opportunities, risks, and criteria and indicators for sustainable practices, *Biomass and Bioenergy*, 33: 1321-1342.
- [30] Levine, M., & Hirose, M. (2005). *Energy efficiency improvement utilising high technology: An assessment of energy use in industry and buildings. Report and Case Studies*. London, UK: World Energy Council.
- [31] Omer, A.M. (2006). Review: Organic waste treatment for power production and energy supply. *Cells and Animal Biology* 1 (2): 34-47.
- [32] Omer, A.M. (2007). Renewable energy resources for electricity generation in Sudan. *Renewable and Sustainable Energy Reviews* 11: 1481-1497.
- [33] Omer, A.M. (2008). Green energies and environment. *Renewable and Sustainable Energy Reviews* 12: 1789-1821.
- [34] Omer, A.M., Yemen, F. (2003). Biogas energy technology in Sudan. *Renewable Energy*, 28 (3): 499-507.
- [35] Pernille, M. (2004). Feature: Danish lessons on district heating. *Energy Resource Sustainable Management and Environmental March/April 2004*: 16-17.
- [36] Robinson, G. (2007). Changes in construction waste management. *Waste Management World*, pp. 43-49. May-June 2007.
- [37] Rossi, S., Arnone, S., Lai, A., Lapenta, E., and Sonnino, A. (1990). ENEA’s activities for developing new crops for energy and industry. In: *Biomass for Energy and Industry* (G. Grassi, G. Gosse, G. dos Santos Eds.). Vol.1, pp.107-113, Elsevier Applied Science, London and New York.
- [38] Rural Industries Research and Development Corporation (RIRDC). (2009). *Sustainability production of bioenergy: a review of global bioenergy sustainability frameworks and assessment systems*.
- [39] Sims, R.H. (2007). Not too late: IPCC identifies renewable energy as a key measure to limit climate change. *Renewable Energy World* 10 (4): 31-39.
- [40] Singh, A. (2008). Biomass conversion to energy in India: a critique. *Renewable and Sustainable Energy Review*, 14: 1367-1378.

DOUBLING THE FARMERS INCOME THROUGH INDO- ISRAEL CITRUS PRODUCTION TECHNOLOGY

D.M.PANCHBHAI*, R.P.GAJBHIYE, Y.R.KHOBRADE, V.U.RAUT

* Faculty of Horticulture, Dr. Panjabrao Deshmukh Krishi Vidyapeeth, Akola

ABSTRACT

Nagpur Mandarin is an important and major fruit crop grown in Central India and area under this crop is 1.47 lakh hectares. The average productivity of the Citrus in India is around 11.08 t ha⁻¹. The major component of limiting the productivity of citrus in India viz. quality planting materials, planting on raised bed, high density planting, use of pruning, use of drip irrigation and fertigation. For the standardization of high density planting four spacing viz, 6m x 6m, 6m x 4m, 6m x 3m, and 6m x 2 m spacing were tried and at the same time seven model demonstration farm were developed in high density planting system along with traditional planting system. Among the all spacing 6m x 3m spacing was found most suitable for Nagpur mandarin in Vidarbha region. Pruning of Nagpur mandarin crop is an essential for canopy management and for improving the quality production. Mechanical citrus pruning machine is used first time in Central India for pruning of Nagpur mandarin orchards. For standardization of pruning time and severity of pruning, tractor drawn pruning machine was used during December-January for *Ambia bahar* on five year old high density (6m X 3m spacing) Nagpur mandarin orchard. *Ambia bahar* fruits of Nagpur mandarin are harvested up to last week of November. December and January is a rest period and again *ambia bahar* flowering are emerge during February. For the standardization of time and severity of pruning, three pruning time (First week of December, third week of December and first week of January) and four pruning levels (8ft from ground level, 10 ft from ground level, 12 ft from ground level and no pruning) was tested during 2013-14. From the result it is revealed that flowering was observed in all treatments. Significantly higher fruit yield (28.91 t ha⁻¹) was recorded in treatment pruning performed at 10 ft height from ground level. Time of pruning also had significant result in case on fruit yield and fruit size. Pruning performed during third week of December resulted significantly maximum yield per ha (25.33t ha⁻¹). As regards the fruit size, significantly maximum fruit weight was recorded when pruning was performed during third week of December, However, significantly maximum fruit diameter was recorded in first week of December. Two to three fold increase in fruit yield and two to two and half fold increase in income to the citrus growers. In addition to the fruit yield and quality, number of branches and leaves were increased in pruned plants as compared to the un-pruned plants. Staking with bamboo is required in un-pruned plants whereas no staking is required in pruned plants. Fruit development was observed inside the canopy and hence it was uniform and bigger size and fruits are protected from sun burn in pruned plants as compared to the un-pruned plants.

Introduction

Nagpur Mandarin is an important and major fruit crop grown in Central India and area under this crop is 1.47 lakh hectares in Vidarbha. The average productivity of the Citrus in India is around 11.08 t ha⁻¹ and 9.16 t ha⁻¹ in Maharashtra state. The major component of limiting the productivity of citrus in India and in Vidarbha region viz. quality planting materials, infestation of phytophthora, planting on raised bed, high density planting, use of pruning, use of drip irrigation and fertigation. Use of good horticultural practices like use of quality planting materials, high density planting, planting on raised bed, provision of drainage around orchards, canopy management, drip irrigation and fertigation are most essential for increasing the productivity of citrus and arrest the infestation of phytophthora. Area under high density planting of Nagpur mandarin is increasing day by day. At present Nagpur mandarin is

commercially cultivated on flat bed with 6 X 6m spacing. However, productivity is low with this spacing and incidence of Phytophthora disease is predominant in the region. Planting of Nagpur mandarin on ridges may be helpful for better drainage and minimizing incidence of Phytophthora disease. Most of the planting materials are prepared by traditional system on ground on same land and hence planting material is infected with phytophthora from nursery stage itself and it spread in main field due to which declining is observed from initial stage of plant growth. This is very limiting factor for lowering the productivity of Nagpur mandarin in India in general and Vidarbha in particular. Quality and disease free planting material of citrus crop play an important role for developing healthy orchard and hence containerised nursery are required for production of quality and disease free planting material.

Citrus is a major fruit crop grown in Vidarbha region on 1.47 lakh hectare area with 9.16 metric tonne productivity. This productivity of citrus is very low and hence to increase the productivity of citrus crop, Government of India decided to have collaborative project with Israel government as a co-operation for increasing the productivity of citrus by using different technology.

As a result of interaction with Israeli experts during their visit to India as well as discussion with various experts in Israel, the following are the technologies/ activities identified to be taken up to improve the quality and productivity of Citrus in Maharashtra state.

Objectives

- Production of disease free planting material of Nagpur mandarin
- To develop good agricultural practices (Planting on raised bed, high density planting, pruning) for increasing the productivity of Nagpur mandarin.
- To conduct trainings for farmers regarding adoption of good agriculture practices (GAP) for improving the yield and quality.

Component:

- Establishment of Model Nursery for Quality Planting Material.
- High Density Planting
- Mechanical Pruning
- Planting on Ridges
- Micro irrigation & Fertigation management

Establishment of model nursery for citrus

- Infrastructures required for nursery are developed and initiated the citrus nursery.
- Net houses for primary nursery (1000sq.m.) and secondary nursery (5000 sq.m.) are established.
- Developed the mother block for scion and rootstock.
- Established the Solarization unit for nursery.
- Initiated the nursery activity for citrus.
- Standardized the protocol for production of quality planting materials of Nagpur mandarin
- Producing 40-50 thousand quality planting materials of Nagpur mandarin.

Model Nursery for production of quality planting materials.

<ul style="list-style-type: none">• Net houses and cage house are installed.	
<ul style="list-style-type: none">• Primary nursery is initiated.	
<ul style="list-style-type: none">• Secondary nursery.	

Varietal mother block

- Varietal block of Nagpur mandarin (Nagpur mandarin and Nagpur seedless) and Sweet orange (Nuecellar and Katol gold) is established.

Establishment of Citrus Rootstock block

- Rootstock blocks of Rangpur lime and rough lemon is established

Demonstration block

- Raised bed as per required are prepared with help of JCB and tractor. Size of raised bed is 3 m width at bottom, 2m width at top and 50cm height.
- Direction of the bed should be North –South.
- Established the demonstration block on raised bed and flat bed with different spacing (6X6m, 6X4m, 6X3m, 6X2m).
- Vegetative growth on raised bed is comparatively more as compared to flat bed.
- No any symptom of phytophthora is seen in both the system of planting.
- Nagpur mandarin on Rangpur lime and rough lemon rootstock are planted on both the planting system i.e. raised bed and flat bed along with different spacing.
- Use of Drip irrigation and fertigation
- Growth of the plant was found significantly superior on raised bed as compared with the flat bed system.

Model demonstration farm at following farmer’s field

Sr. No.	Name	Address	Dist.	Area
1	Ku. Kranti. A. Gharad,	Nimaji, Kalmeshwar	Nagpur	1.00 ha
2	Sh. Niraj Junghare	Hatala, Katol	Nagpur	1.00 ha
3	Sh. Ashok Ridhorkar,	Ladgaon, Katol	Nagpur	1.00 ha
4	Sh. Manoj Jawanjal	Katol	Nagpur	1.00 ha
5	Sh Anil Lekurwade,	S, ghat, Warud	Amravati	1.00 ha
6	Sh. Ramesh Jichkar,	Nagziri., Warud	Amravati	1.00 ha
7	Sh. Manoj Pelagade,	Jamgaon, Warud	Amravati	1.00 ha
		Total area		7.00ha

- In addition to the above farmers, more than 500 farmers adopted the same technology as a impact of training and demonstration of planting on raised bed with 6 X 3m spacing.

<ul style="list-style-type: none"> • Model plot of Nagpur mandarin at 6mX3m on raised bed. 	
---	--

Use of Drip and fertigation

Since the first year of plantation double 16mm in line lateral of 4lph having 50 cm distance between the two drippers were used. Uniform and timely irrigation through drip have given in both the planting system. It is clearly seen that 30 % more vegetative growth of the plants was noticed on raised bed as compared to traditional system of planting. Following fertigation protocol was developed for Nagpur mandarin.

Nitrogen application for New / young plants (Spacing 6X3m)

Age in year	Urea in gram per ha at every four day(g)	Interval of fertigation	Time of fertigation	Total quantity of Urea required(Kg)
1	1932	4 day	Jan-May, Sept-Dec	130
2	3865	4 day	Jan-May, Sept-Dec	260
3	5798	4 day	Jan-May, Sept-Dec	392
4	7730	4 day	Jan-May, Sept-Dec	522

Phosphorus application for new / young plants (Spacing 6X3m)

Age	SSP per ha at every 45 days (Kg)	Interval of fertigation	Time of fertigation	Total quantity of SSP required(Kg)
1	31.25	45 day	Jan-May, Sept-Dec	187.6
2	62.50	45day	Jan-May, Sept-Dec	375.2
3	93.75	45day	Jan-May, Sept-Dec	562.8
4	125.00	45 day	Jan-May, Sept-Dec	750.4

Potash application for new / young plants (Spacing 6X3m)

Age	MOP per ha at every 45 days (Kg)	Interval of fertigation	Time of fertigation	Total quantity of MOP required(Kg)
1	16.66	45 day	Jan-May, Sept-Dec	100
2	33.33	45day	Jan-May, Sept-Dec	200
3	49.98	45day	Jan-May, Sept-Dec	300
4	66.64	45 day	Jan-May, Sept-Dec	400

Note: SSP:- First year: 56 g per plant at 45 days interval through soil application
MOP: First year: 30 g per plant at 45 days interval through soil application
(During Jan-June & Sept-Dec.)

Fertilizer application for bearing plants (Spacing 6X3m)

Age	Quarter for fertigation	Days of quarter	Fertigation interval (days)	Quantity of urea required per fertigation(Kg/ha)	Total qt of Urea/ha/quarter (Kg/ha)
	1	40	12	40.8	135.9
	2	20	12	81.5	135.9
	3	50	12	45.7	190.2
	4	20	12	48.9	81.5

Total dose of NPK in Kg per year per ha. : 250, 125, 250

Sr. No.	Quarter	Stage	Duration	Urea(kg/ha)	SSP(kg/ha)	MOP(kg/ha)
1	1 st quarter	Blossom	40	135.9	234.4	104.2
2	2 nd quarter	Fruit set	20	135.9	234.4	104.2
3	3 rd quarter	Fruit growth stage -1	50	190.2	156.3	145.8
4	4 th quarter	Fruit growth stage -2	20	81.5	156.3	62.5
		Total	130	543.5	781.3	416.7
		No. of bag		10.9	15.6	8.3

Note: Urea may give through drip and SSP and MOP through soil application manually as per quarter.

Pruning component

- For the pruning of citrus, tractor drawn pruning machine is procured from Italy during March, 2013.
- Demonstration regarding mechanical pruning to the citrus growers of Nagpur and Amravati districts was undertaken.
- Pruning intensity was decided as per the condition of orchard condition. However, 1.00m to 1.5m branches cutted from the top in old orchard and pruning was done at 3m (10 feet) from ground layer was done in regular orchards.

Pruning for *Ambia bahar*

Sr. No.	Time of pruning	District	No. of plants pruned
1	Dec- 2013 – Jan-2014	Nagpur and Amravati	8953
2	Dec- 2014 – Jan-2015	Nagpur and Amravati	8200
3	Dec- 2015 – Jan-2016	Nagpur and Amravati	10560

Pruning for *Mrig bahar*

Sr. No.	Time of pruning	District	No. of plants pruned
1	June, 2013	Amravati	6345
3	June, 2014	Nagpur and Amravati	5600
4	June, 2015	Nagpur and Amravati	8230

Fruit yield of Nagpur mandarin as influenced by time and severity of pruning under high density planting at early stage of fruiting. (Pooled mean of three years)

Severity of pruning(P)	Time of pruning(T)			Mean
	T1-First week of Dec.	T2-Third week of Dec	T3 First week of Jan.	
P1- No pruning	20.23	19.50	18.27	19.33
P2- pruning at 8 ft height	26.97	27.55	26.66	26.93
P3-pruning at 10 ft height	28.48	31.07	27.19	28.91
P4-pruning at 12 ft height	23.31	23.21	22.53	23.02
Mean	24.74	25.33	23.66	
	Factor A Severity of pruning	Factor B Time of pruning	A x B	
F test	Sig	Sig.	Sig	
SE m+	0.21	0.18	0.44	
CD at 5%	0.61	0.53	1.30	

Effect of Severity of pruning (Pooled yield ha⁻¹)

Data in respect of yield ha⁻¹ is revealed that, the yield ha⁻¹ was significantly influenced by severity of pruning. Significantly maximum yield ha⁻¹ (28.91 t) was recorded in pruning at 10 ft height (P₃). However, minimum yield ha⁻¹ (19.33 t) was recorded in No pruning treatment.

Effect of Time of pruning

Data in respect of yield of fruits ha⁻¹ is revealed that, the yield ha⁻¹ was significantly influenced by time of pruning. Significantly maximum yield ha⁻¹ (25.33 t) was recorded when pruning was performed in third week of December (T₂). However, minimum yield ha⁻¹ (23.66 t) was recorded when pruning was performed in first week of January (T₃).

Interaction effect of severity and time of pruning









Interaction effect of severity and time of pruning was found significant. Significantly maximum yield ha⁻¹ (31.07 t) was recorded in interaction effect P₃T₂ (pruning at 10 ft height and third week of December). However, minimum yield ha⁻¹ (18.27 t) was recorded in interaction effect P₁T₃ (No pruning).

Benefits of pruning

- Pruning is most useful for Nagpur mandarin during December- January for *ambia bahar* fruits and June for *mrig bahar*.
- Pruning intensity may be decided as per the orchard conditions.
- Medium type of pruning (removing 90-100cm branches from top) found most suitable for Nagpur mandarin.
- Pruning helps to rejuvenate the orchard and increase the productive life of mandarin orchards.
- Fruit size is increase due to pruning as fruit bears in plant canopy.
- No. of branches and foliage is increase due to pruning and hence improve the quality of fruits and prevent from sun burning.
- Increased grade-A fruits upto 80 % and hence fetches more price in market.
- Pruning helps in increasing the fruit yield ranging from 20.77 to 44.32 t ha⁻¹.
- Staking is not required after pruning.
- Fruit drop are also minimize due to pruning.

- Mechanical tree pruner is useful for commercial and timely pruning in citrus.

Pruning technology for citrus

 <p>Pruning with pruning machine</p>	 <p>After pruning</p>
 <p>After pruning</p>	 <p>Fruiting after pruning</p>
 <p>View of orchard after pruning</p>	 <p>Fruiting after pruning</p>
 <p>Staking is required without pruning</p>	 <p>No staking required after pruning</p>

During, 2016 two recommendations are given to the state government.

1. Indo-Israel citrus production technology, Recommendation

High density planting at 6mX3m on raised bed (Indo-Israel Citrus Production Technology) is recommended for obtaining better growth, yield and quality fruits of Nagpur Mandarin.

Indo-Israel Citrus production Technology

- Provision of Drainage at field (Drainage line of one meter width and one meter depth)

- Planting on raised bed(Bed size: Three meter width and 50cm height, bed direction : North- South)
- Hi-density planting on 6mX3m.
- Provision of drip irrigation system(double lateral)
- Fertilizer application through drip.
- Use of pruning technology for canopy management.
- Timely control of pest and diseases.

2. Pruning technology for citrus.

Recommendation:

Pruning during third week of December at 10ft height is recommended for obtaining higher and better quality yield of *Ambia bahar* in Nagpur mandarin under high density planting at 6m x 3m.

Training Component

- State level workshop was organized.
- On farm trainings to the state Agricultural Officers and citrus growers were organized in Nagpur and Amravati division regarding bed preparation, planting, irrigation management, fertigation, pruning, plant protection etc along with Israeli citrus Expert.
- Delivered the lecturers on high density planting and citrus technology in workshop, Kisan melas, and Sheti shala through which 27436 officials and farmers are benefited.
- National level seminar organized for all Centre of Excellence for Citrus established under Indo-Israel project at CEF, Mangiana, Haryana, CEF, Hoshiyarpur(Punjab) and CEC, Kota(Rajasthan).
- International seminar on Citrus production technology was organized during December 2014.

Future prospects

- Indo-Israel Citrus Production technology is included in state government fruit plantation scheme.
- MNREGA also initiated this activity in their programme for new plantation of citrus.
- Citrus growers are more interested procurement of quality planting materials, high density planting and canopy management through mechanical pruning as the results of pruning have very good impact.
- Manual pruning require trained man power and it should be completed within one month and it is very difficult to complete within stipulated period due to trained labour constrains.
- Hence, mechanical pruner will be helpful for citrus grower.

Acknowledgement:

Thanks to Mission for Integrated Development of Horticulture for providing financial support, Embassy of Israel for providing technical support and Dr. Panjabrao Deshmukh Krishi Vidyapeeth, Akola for providing support for effective implementation of the project.

Literature cited

1. Wheaton T. Adher, Castle W.A., Tucker D.P.H., Whitney J.D. (1978): Higher density planting in Florida citrus- concepts. *Proc. Flo. State Hort. Soc.*91:27-33.
2. Tucker D.P.H. and Wheaton T. Adher, (1978): Trends in Higher citrus planding densities. *Proc. Flo. State Hort. Soc.*91:36-40.
3. Aubert B. (1990): High density planting (HDP) of Jiaogan mandarin in the lowland area of Shantaou (Guangdong China) and implications for greening control. *Proceeding of the 4th International Asia Pacific Conference on Citrus rehabilitation. Chiang Mai, Thailand, 4-10th Feb, 1990.*

4. Wheaton T.A., Whitney J.D., Castle W.S., Muraro R.P., Browning H.W. and Tucker D.P.H. (1995): Citrus scion and rootstock, topping height and tree spacing affect tree size, yield, fruit quality and economic return. *J. Amer. Soc. Hort. Sci.* 120(5).
5. Muhammad Azher Nawaz, Waqar Ahmed, Jahid Iqbal and Muhammad Mumtaz Khan (2007): Evaluation of high-density plantation on vigor and yield in Kinnow mandarin (*Citrus reticulata* Blanco). *Proc. Int. Sym. on Prospects of Hort. Industry in Pakistan.* 28-30 March, 2007.
6. Waqas Ahmed Dogar, Arshad Ali Khan, Saeed Ahmed, Sudheer Tariq, Mukhtar Ahmad, Muhammad Imran, Muhammad Noman, and Naddem Khan (2017): Study to determine the effect of high-density plantation on growth, and yield of citrus. *Sarhad j. Agriculture*, 33(2): 315-319.

EXPLORING THE DYNAMIC INTERACTION OF INSECT VECTOR AND PLANT VIRUSES ON MOLECULAR PRINCIPLES

RABIYA BASRI^{1*}, MOHAMMAD AKRAM², ANKUR TRIPATHI³ AND WAJID HASAN⁴

¹School of Agriculture, ITM University, Gwalior

²Department of Plant Protection, Faculty of Agriculture Science, Aligarh Muslim University

³Department of Basic Sciences, Agriculture University, Jodhpur, Rajasthan

⁴Krishi Vigyan Kendra, Jahanabad, Bihar Agricultural University, Bihar

ABSTRACT

Insect mediated plant viruses and phytoplasma diseases are emerging as a serious threat in relation productivity of horticultural crops. Various environmental factors including climate change, migration and agronomic practices are considered to play an important role in the emergence of viral diseases of plants. The insect vector interactions with plant viruses vary in duration and specificity but some plant viruses encode structural proteins on the surface of the virion that are essential for transmission, and also additional non-structural helper proteins that act to bridge the virion to the vector binding site. Moreover, viruses can also bind to specific sites in or on the insect vectors and are remain there until they are transmitted to their plant host. Plant viruses tend to rely on their vectors for rupturing the plant cell wall to be delivered directly into the cytoplasm. Mostly, viral capsid or membrane glycoproteins are the specific proteins that are required for virus transmission and determining the specificity of vector. Specific molecules responsible for virus transmission in vectors also interact with the virus. There are several identified and non-identified receptors for viral molecules recognition which needs to be explore in insect vector and virus interaction phenomenon. Specificity of virus transmission by particular vectors, is a defined step that represent targets for interdiction strategies to disrupt the disease cycle through transmission. New technologies aimed to disrupt the virus–vector interaction can be investigated to understand the importance of integration of these technologies with advance methods for viral disease management in plants. Scientific evidences shows that plant viruses can influence physiology and behaviour of insect vector to increase the probability of transmission, either directly or through modification in metabolism of host plant. In contrast, less literature is found on the study of possible reciprocal interaction of insect vector and their significant impact on the behavior and/or phenotype of plant viruses within the infected plants, on its population genetics and its evolution. On the basis of previous studies, viruses can induce changes in insect vector behavior, physiology and population dynamics. The feeding habits of insect vectors can impact the evolution of plant viruses. Further study on all these aspects can strengthen the evidence related to possibility that stress imposed due to insect vector could induce major switches in the ‘behavior’ of viruses in plants.

EFFECT OF DIFFERENT BLENDS OF AROMATIC POWDERS ON QUALITY OF DRUMSTICK LEAF GREEN TEA POWDER

BHUVANESHWARI G^{*}, MADHUKARA², VASANT M. GANIGER³ AND RUDRESH D. L.⁴

^{*} Dept. of Postharvest Management, College of Horticulture, Bagalkot, Karnataka and University of Horticultural Sciences, Bagalkot-587104, Karnataka, India

ABSTRACT

Drumstick (*Moringa oleifera* Lam.) is an under exploited perennial vegetable species of Moringaceae family, native to the Sub-Himalayan tracts of India, Pakistan, Bangladesh and Afghanistan. This rapidly growing tree is also known as the *horseradish tree*, *drumstick tree*, *benzolive tree*, *kelor*, *marango*, *mlonge*, *moonga*, *mulangay*, *nebeday*, *saijhan*, *sajna* or *ben oil tree*. Drumstick leaf is the most potent part of the plant. India's ancient tradition of Ayurveda medicine sites 300 diseases that are treated with the powdered leaf of the moringa tree. Pure powdered capsules are organic and absolutely safe. It is one of the most secret performance enhancing products taken by athletes. Drumstick leaves have been reported to be rich sources of several antioxidants such as polyphenols and carotenoids which may be beneficial for the prevention of several chronic degenerative disorders (CDDs). The leaf powder can provide 14 per cent of the protein, 40 per cent of the calcium, 23 per cent of the iron and most of the vitamin A needs of one to three year old children. Six tablespoons of leaf powder is reported to provide nearly all of the woman's daily iron and calcium needs during pregnancy and breastfeeding (Martin, 1985). Moringa is especially promising as a food source in the tropics because the tree is in full leaf at the end of the dry season when the other foods are typically scarce. Drumstick leaves are found to be a potential source of natural antioxidants due to their marked antioxidant activity. Antioxidants neutralize free radicals in the body, maintain healthy vision and may reduce risk of cancer (colon, prostate, skin), cognitive impairment, immune dysfunction and cardiovascular diseases.

Green tea has been described as a revelation for people looking for a healthy yet great-tasting drink. It is a natural source of antioxidants that may help to protect the body from damage caused by free radicals and is naturally low in calories when served without milk or sugar. These characteristics make green tea an ideal accompaniment for people wanting a healthy lifestyle today. Thus, an attempt was made to know the effect of different blends of aromatic powders on quality of drumstick leaf tea powder to extend post harvest useful life span and to optimize conditions in the production of drumstick leaves tea powder.

Methodology

Bagalkot is situated in the northern dry zone (Zone-3) of Karnataka. The centre is located at 75° 42' East longitude and 16° 10' North latitude with an altitude of 542.00 m above Mean Sea Level (MSL). The leaves of KDM-01 (Bhagya) a newly released variety of University of Horticultural Sciences was used for the study. This variety grows best in tropical and subtropical regions. It grows up to 2.5 to 3.0 m height, having average pod length of 65 to 70 cm and leaves are rich source of β - carotene, vitamin C and iron. Drumstick leaves dried in electric tray drier at 60°C for 17 hrs was scored highest and it was used for powder preparation by hand crushing and passing leaves through 0.5 mm mesh sieve. The prepared drumstick leaves tea powder was blended with *Tulsi* powder (var. Krishna), Ginger powder and lemongrass powder at different percentage as mention in treatment details. The experiment was laid out in a completely randomized design with 10 treatments and three replications.

Treatment details:

Treatments	Proportion of different blends of drumstick tea powder
T ₁	: Drumstick leaf powder (98%) + Tulsi leaf powder (2%)
T ₂	: Drumstick leaf powder (96%) + Tulsi leaf powder (4%)
T ₃	: Drumstick leaf powder (94%) + Tulsi leaf powder (6%)
T ₄	: Drumstick leaf powder (98%) + Ginger powder (2%)
T ₅	: Drumstick leaf powder (96%) + Ginger powder (4%)
T ₆	: Drumstick leaf powder (94%) + Ginger powder (6%)
T ₇	: Drumstick leaf powder (98%) + Lemongrass powder (2%)
T ₈	: Drumstick leaf powder (96%) + Lemongrass powder (4%)
T ₉	: Drumstick leaf powder (94%) + Lemongrass powder (6%)
T ₁₀	: Drumstick leaf powder (Control)

A known weight of fresh drumstick leaves was dried in hot air oven at 55°C temperature till a constant weight to obtain moisture content. Total ash content was determined by burning the drumstick leaf powder in pre-weighed crucible in a muffle furnace at 550°C for 6 hours (Rao and Bingren, 2009). Total phenol content in the sample was estimated as per the Folin Ciocalteu Reagent (FCR) method (Sadasivam and Manickam, 2005). Samples of the drumstick leaf were analysed for their ascorbic acid content using 2, 6-dichlorophenol Indophenol method (Anon., 1975). Chlorophyll *a*, chlorophyll *b* and total chlorophyll contents were determined by following the dimethyl sulfoxide (DMSO) method described by Nanja *et al.* (1990). Water extractives of the drumstick leaf powder was determined as per the method of Kirk and Sawyer (1997). The percentage of 2,2-diphenyl-1-picrylhydrazyl (DPPH) radical scavenging activity of the samples was determined by a method described by Eghdami and Sadeghi (2010). Sensory evaluation of drumstick leaves tea was carried out by a panel of semi-trained judges consisting of Teachers and Post-Graduate students of College of Horticulture, Bagalkot. The sensory characters like colour and appearance, taste and flavour, mouth feel (texture) and overall acceptability were evaluated on a 9 point Hedonic scale using the score card.

Results

The moisture content of drumstick leaf tea powder is usually used as an indicator of quality. It is important to measure the moisture content because of its potential impact on the sensory, physical and microbial properties of the drumstick leaf tea powder. In the present study among the treatments, the moisture content was reported to be non significant. However, minimum moisture content (7.69 %) was recorded in T₉ (Drumstick leaf powder + 6 % lemongrass powder) and T₈ (Drumstick leaf powder + 4 % lemongrass powder) and the highest moisture content (7.90%) was recorded in T₁₀ (Control).

The dry matter and ash content in drumstick leaves tea powder was found to be higher in T₉ (Drumstick leaves powder + 6 % lemongrass powder) and T₈ (Drumstick leaves powder + 4 % lemongrass powder). Other aromatic plants like tulasi and ginger have showed less dry matter and ash content than lemongrass. Total chlorophyll consists of chlorophyll *a* and chlorophyll *b*. Total chlorophyll content of drumstick leaves powder blended with different concentration of aromatic powder has shown a significant differences among treatments. In the present study the drumstick tea powder blended with lemongrass powder was recorded highest chlorophyll content (31.93 mg/g) followed by drumstick tea powder blended with tulasi (29.80 mg/g) and ginger (26.04 mg/g).

Ascorbic acid is one of the important components of the product from nutritional point of view and phenols are the group of chemicals responsible for astringent taste of teas. The total

ascorbic acid and total phenol content of drumstick leaf tea powder was found significantly different among the treatments due to the use of different concentration of aromatic powders. The maximum level of both ascorbic acid and phenolic content was recorded in T₉ (Drumstick leaves powder + 6 % lemongrass powder) and T₈ (Drumstick leaves powder + 4 % lemongrass powder). The highest concentration of ascorbic acid and phenolic content was recorded in T₉. The minimum concentration of ascorbic acid and phenolic compounds was observed in T₁₀ (control) because this treatment includes drumstick leaves alone.

Water soluble extractives (WSE) indicate percentage of extractive that can be dissolved during the brewing of the tea. In the present study, the WSE was reported maximum in T₉ (6.93%). The higher concentration of lemongrass powder, higher the WSE was observed in the treatment. Herbal plants are known to contain a variety of antioxidants. Numerous substances have been suggested to serve as antioxidants. In the present investigation, the lemongrass blended with drumstick leaves powder has recorded highest antioxidant activity. Evaluation of sensory qualities of a food product is an important tool in deciding the consumer's acceptability besides its nutritional qualities. The aromatic powder blended drumstick leaves tea powder developed by incorporating different concentration of lemongrass, tulasi and ginger had significant variations with respect to all the aspects of sensory quality. The maximum score (8.70) for appearance in terms of colour was recorded in T₉ (Drumstick leaf powder blended with 6 % lemongrass powder). More quantity of lemongrass powder in treatment T₉ imparted more natural green colour to the drumstick tea powder which attracted the sensory panel resulting in maximum score.

Maximum score (7.90) for taste and flavour was in T₉. This may be attributed to the individual perception by the panel as optimum with respect to the proportion of various aromatic powder used in this treatment. The minimum score for taste and flavour was recorded in T₁₀ (6.55). The higher concentration of lemongrass powder in T₉ might have contributed to appreciable mouth feel (7.63) followed by T₈ (7.44). In total, significantly maximum score for overall acceptability (Fig. 7) was recorded in T₉ (7.82) and minimum score was recorded in T₁₀ (6.23) clearly indicates judges ability in differentiating sensorial quality of the product.

Conclusion

Among the three aromatic blends *viz.*, tulsi, ginger and lemon grass in the preparation of drumstick leaves green tea powder, the blending composed of higher concentration of lemon grass treatment T₉ (Drumstick leaf powder + 6 % lemongrass powder) was found optimum by scoring maximum for organoleptic properties and was also found nutritionally superior.

REFERENCES

- Anonymous, 1975, *Official Method of Analysis*, Association of Official Analytical Chemists (A O A C), 12th Edn. Washington, DC., pp. 554-829.
- Eghdami, A. and Sadeghi, F., 2010, Determination of total phenolic and flavonoids contents in methanolic and aqueous extract of *Achillea millefolium*. *Org. Chem. J.*, **2**: 81-84.
- Kirk, R. S. and Sawyer, R., 1997, *Pearson's Composition and Analysis of Foods*. 9th Ed. Longman Singapore publishers; Singapore, pp. 356-361.
- Nanja, R. Y. A., Shaanker, U. T. G., Prasad, M. and Kumar, U., 1990, Physiological approaches to improving harvest index and productivity in sunflower. *HELIA*, **26**: 81-90.
- Rao, Y. and Bingren, X., 2009, Determination of total ash and acid insoluble ash by NIS. *The Pharm. Soc. Japan*, **129**: 881-886.
- Sadasivam, M. S. and Manickam, A., 2005, *Biochemical Methods*. New Age International Publishers, Second edition. pp.193-194.

VARIETAL EVALUATION OF STRAWBERRY IN INDO GANGETIC PLANE OF BIHAR

RUBY RANI*, HIDAYTULLAH MIR, FEZA AHMAD, SANJAY SAHAY, KUMARI KARUNA AND PAWAN KUMAR

Department of Horticulture (Fruit & Fruit Tech.), BAU, Sabour

Strawberry is considered as temperate fruit and considered as short-day plant. It is very nutritive fruit with high antioxidant property. Thus, demand of fruits are increasing day by day. With advent of new day neutral varieties and technologies strawberry can be grown in subtropical climate also. In view of the increasing demand of strawberry fruits its cultivation is now increasing in agroclimatic condition of Bihar, India. But selection of good variety is essential to fetch higher income with better yield and quality. Thus, in order to test the feasibility of different varieties in the state an experiment was conducted to evaluate the performance of nineteen strawberry varieties in Bihar condition.

Methodology:

The experiment was conducted in experimental plot of BAU Sabour for two consecutive years during 2017-18 with nineteen strawberry varieties laid out in RBD with three replications. Plants were planted in first fortnight of October in both the years on raised bed at a planting distance of 25 cm. Observations were taken on plant growth yield and quality parameters. Standard methods were adopted for quality analysis of fruits.

Results:

The significant difference among varieties was noted for plant growth, flowering, fruit set, yield parameters and fruit quality of strawberry during both the years. Significant effect of years was also noted due to variation in weather parameters in both the years. The maximum plant growth in terms of plant height, spread and leaf number per plant was observed in variety Nabila, Sabrina, Festival and Crystal. Similarly, number of flowers were maximum in var. Fortuna (29.05 flowers /plant) which was at par with Sweet Charlie, Douglas, Nabila and Chandler followed by Winter Dawn and Elyana. The minimum number of flowers was noted in Missionary (14.28 flowers/plant). The maximum number of fruits per plant was recorded in variety Nabila (18.98 fruits/plant) which was at par with Festival, Sweet Charlie, Cama Rosa Hadar, Douglas and winter Dawn and the minimum flowers number of 11.48 per plant in Sweet Catrin. Significantly highest fruit weight (15.47g) was also recorded in variety Nabila and it was followed by variety Crystal, Fortuna, Festival. Similarly the highest yield per plant was recorded in variety Nabila (291.71 g/plant) followed by Festival, Cama Rosa, Sweet Charlie and minimum yield of 72.15g per plant was noted in variety Sweet Catrin. The varietal difference in plant growth and yield in strawberry has also been reported by Muzaffar et al (2021) and Ikegaya et al (2021) in different agroclimatic conditions. The fruit quality in terms of maximum TSS (11.97-degree B) was measured in Nabila and it was at par with Festival, Sweet Charlie and Fortuna. Significant difference among varieties was noted with respect to acidity content also.

Conclusion:

On the basis of above findings, it can be concluded that variety Nabila, Festival, Sweet Charlie, Cama Rosa and Fortuna were the suitable for growing in Bihar condition.

References:

Ikegaya, Atsushi, Seiji Ohba, Tomoyasu Toyozumi & Eiko Arai (2021) Quality Evaluation of Strawberries Grown in Various Regions by Singaporeans and Japanese, International Journal of Fruit Science, 21:1, 883-895

Muzaffar, Mir, Jamwal Sudhir, Gupta Ajay, Hassan G.I., Sharma Rakesh, Guroo Mushtaq, Slat hia Siloni (2021) Ind Jr Horticulture Volume : 16, Issue : 2 page 463- 466

Table: Growth and yield parameters of different strawberry varieties

	Plant Height (cm)	Plant Spread (cm)	Leaf no./plant	No. of flowers /plant	No of fruits/ plant	Fruit weight (g)	Yield/ plant(g)	TSS(degrees brix)	Acidity (%)
Came Rosa	23.68	34.56	34.30	24.52	17.50	13.20	231.82	9.90	0.453
Chandler	31.14	37.20	32.13	27.62	16.46	11.65	191.77	10.02	0.368
Crystal	34.66	36.90	34.33	23.18	13.72	14.08	193.85	11.10	0.487
Douglas	23.80	30.40	35.20	28.10	16.80	9.36	157.30	8.85	0.625
Elyana	29.20	26.50	31.60	27.05	16.89	10.16	171.60	8.92	0.584
Festival	34.56	37.61	36.49	25.27	18.30	13.80	248.90	11.82	0.447
Fortuna	31.15	31.41	37.10	29.05	15.49	14.02	217.10	11.22	0.510
Missionary	19.10	27.35	26.15	14.28	11.48	8.90	102.15	7.13	0.652
Ofra	32.60	36.50	37.20	18.10	11.92	13.59	161.93	9.71	0.421
Sabrina	37.90	43.56	37.90	18.63	13.76	13.52	180.61	11.20	0.369
Safari	19.71	22.75	21.10	22.70	12.71	7.11	90.36	9.32	0.625
Sengasengana	23.89	32.40	22.70	23.68	14.06	9.52	133.86	8.22	0.425
Sweet catrin	20.01	25.37	18.15	19.15	12.21	7.07	72.15	7.41	0.654
Sweet Charlie	30.10	37.80	27.25	28.92	17.88	12.38	221.40	11.68	0.560
Winter Dawn	27.80	33.68	35.50	27.32	16.72	12.47	208.50	10.82	0.425
Barak	33.22	36.80	37.10	25.70	15.72	11.50	174.56	9.93	0.502
Gili	26.50	33.90	34.56	25.85	15.86	12.01	190.50	10.20	0.513
Hadar	29.36	36.85	34.20	26.70	17.31	12.16	210.56	8.91	0.541
Nabila	37.72	36.20	38.90	28.10	18.98	15.37	291.71	11.97	0.471
C.D(P=0.05)	0.58	0.73	1.89	1.46	0.85	0.48	12.58	0.25	0.054

**NEW RECORD OF *Metanastria hyrtaca* (Cramer, 1779) (Lepidoptera: Lasiocampidae),
A DEFOLIATOR PEST, FROM TIUNI, DEHRA DUN, UTTARAKHAND (INDIA)
WITH HOST PLANTS AND CONTROL MEASURES**

¹AKHLAQ HUSAIN, ²WAJID HASAN AND RAJESH PANWAR³

¹Zoological Survey of India (former Scientist-E)

41, Hari Vihar, Vijay Park, Chakrata Road, Dehra Dun - 248001, Uttarakhand, India

²Krishi Vigyan Kendra, Jahanabad - 804432, Bihar, India

³Govt. Higher Secondary School, Maindrath, Tiuni- 248199, Dehra Dun, Uttarakhand, India

ABSTRACT

Metanastria hyrtaca (Cramer, 1779), being a sporadic lepidopteran pest, its caterpillars congregate on the trunks of isolated host plants and feed voraciously on their tender foliage and other leaves, defoliating them badly so also called ‘defoliating caterpillars’. Recently a group of its larvae were sighted in a school campus at village Maindrath near Tiuni, Dehra Dun district, Uttarakhand (India) and recorded here as new to the area with its systematic account, larval host plants and control measures.

Keywords: new record, *Metanastria hyrtaca*, Tiuni, Dehra Dun.

**MINING AND LAND DEGRADATION IN COAL MINED LANDSCAPE:
RESTORATION PATHWAYS FOR DEVELOPMENT OF RESILIENT
ECOSYSTEMS IN CENTRAL INDIA**

SL SWAMY¹;

¹Indira Gandhi Agricultural University, Raipur (CG) India

Land degradation has become a serious problem creating multifaceted environmental, economic and social challenges before planners, policy makers and scientific communities to leverage technologies leading to land degradation neutrality (LDN). About 23% of the land resources of the world are by and large affected by degradation and further expanding at the rate of 5 to 10 million ha per annum (Stavi and Lal, 2014), while 44% of the India’s landmass is degraded owing to deforestation, inappropriate land use, soil erosion, water logging, industrial expansion, infrastructure, excessive mining etc. Coal mining is the major industrial activity in Central India is key for the thermal power production. It is estimated more than 150 million tonnes of coal produced from Chhattisgarh alone leaving Madhya Pradesh and Maharashtra. Nevertheless, coal mining, especially the open cast mining is most disastrous often associated with undesirable land use changes, environmental degradation, biodiversity losses, health hazards, disruption of livelihoods culminating with long-term socio-economic and ecological consequences. Understanding how the coal mining activities increase the risk and vulnerability of land degradation in different land uses is therefore essential to devise site-specific restoration plans for complementing the national targets of land degradation neutrality (LDN). The present study has been conducted in three coal mining areas in Central India using geospatial techniques. Landsat TM and OLI Satellite data corresponding to the last three decades were digitally analysed using supervised classification employing maximum likelihood algorithm in ERDAS Imagine and Arc-GIS platforms. Spatial and temporal analysis of satellite data revealed that the study area has undergone a remarkable change in land use and land cover changes due to coal mining and associated activities at three sites. The forest and agriculture lands were mostly destructed in all three sites, while the area mining was unevenly expanded. Mining has also resulted in increase of the built up area and also network of roads for disposal of coal. The area under waterbodies lost for these anthropogenic disturbances.

Diversification of productive lands due to mining resulted in severe land degradation, further selective logging, intensive agriculture and overgrazing exacerbated degradation. The mining disturbances degenerated the soil health, where pH, organic carbon (SOC) and available N drastically reduced the soil quality under mined and degraded lands. Land degradation vulnerability index (LDVI) were developed by integrating the biophysical, soil and meteorological factors under ArcGIS. The LDVI map shows that mined areas were highly vulnerable followed by barren wasteland, agriculture and forest, while destructive mining and other associated activities in the past 20 years converted the 50% of the landscape became vulnerable to degradation. The strategic interventions for eco restoration of the degraded landscapes in mined environs were evolved to repair the vulnerable ecosystems. The extreme to high vulnerability zones could be placed on top priority for treatment followed by moderately vulnerable zones for counteracting the process of degradation. While, these zones in proximity to mined areas and its surroundings need rather special attention, conserving gentle slopes near the human settlements with discouraging over grazing and logging. The top soil of dumps need to be stabilized and reconstructed for fostering biological reclamation, while the preference will be given rejuvenating indigenous grasses, shrubs and hardy over exotics because they are likely to yield positive results. Similarly, in agricultural landscapes, it is suggested to adopt sustainable land management (SLM) practices like agroforestry, crop rotation, organic farming, cover crops, residue mulching, biochar application, vegetative strips, conservation tillage, contour, strip farming along with suitable mechanical soil and water conservation measures for bringing resilience in degraded agroecosystem. Overgrazing practices systems prevalent in the region could be replaced with rotational grazing to halt degradation of rangelands and planting of nutritive and high productive forage grasses, legumes and fodder trees could be encouraged to ensure the fodder available in different seasons. Unlike agriculture, degradation of forested landscape was quite enormous which has been increased with continuous deforestation due to mining, it has been advocated to protect and conserve the remnant forests especially on vulnerable sites to reduce and reverse the land degradation process which could improve regeneration and development of forest. Afforestation and reforestation with native species along with soil conservation measures in moderately degraded forests, while the temporary closures and erosion control measures in highly degraded forest lands and plantations could nurture forest landscape restoration. The comprehensive site specific biological restoration plans in accordance with land use patterns were suggested to reclaim the degraded ecosystems in a mined environment to supplement the national goal of achieving net zero land degradation by 2030 under the ambitious programmes of UNCCD.

Keywords: AHP; Energy crisis; Geospatial techniques; Multi Criteria Decisions; LDVI; LDN; ZNLD

STRATEGIES TO COMBAT CLIMATE CHANGE FOR PULSE PRODUCTION

ANITA BABBAR, PRINCIPAL SCIENTIST (PULSE BREEDING)
Department of Plant Breeding and Genetics, JNKVV, Jabalpur, M.P.

Agriculture globally must meet the challenge of feeding a growing population while minimizing its environmental impacts. Global food production needs to be doubled by 50% by the middle of 21st century to ensure the food and nutritional security for 9 billion people explicitly in the challenging scenarios such as land degradation, water scarcity and environmental pollution. The population of India will peak at 1.6 billion in 2048. For India, there is an additional challenge of making farming profitable for small landholders. Low-input both in terms of natural resources and monetary inputs should be taken into account for profitable agriculture. Input, output analysis shows that bringing about low-input, high-output agriculture which would require curbing the over-exploitation of groundwater resources, soil analysis-based use of fertilizers, conservation agriculture, crop diversification, and doubling of the crop and livestock productivity. Crops need to be protected from pests and pathogens, and abiotic stresses.

World witnessed a rise in global average temperature and atmospheric CO₂ concentration by 0.2 °C and 20% over the last five years (2015–19), respectively as compared to 2011–15 (WMO, 2019). Increasing concentration of greenhouse gases (GHGs) [carbon dioxide (CO₂), methane (CH₄) and nitrous oxide (N₂O)] act as catalyst on enhancing global temperature which in turn affecting heat-sensitive pulse crops.

Food production, food security and climate change are intrinsically linked. Climate change impacts several aspects of agricultural production systems including alteration in flowering phenology, water availability, soil fertility and erosion, increase in pathogen spread and host susceptibility (Rosenzweig and Hillel, 1995). Climate change is likely to exacerbate regional and global water scarcity to a great extent. These climate change induced vulnerabilities possess a serious threat to the global food and nutritional security. There is an urgent need to identify crops that can mitigate the threats of climate change. Grain legumes can emerge as one such suitable group of crops having prospects for future.

Pulses provide protein of high biological value in vegetarian diets overcoming malnutrition in masses. In rotation with cereal crops, pulses not only serve in nitrogen economy but also enrich soil health as major portion of leaves fall in the field adding organic carbon and most of micronutrients. Inclusion of pulses in daily diet prevents numerous health problems like cardiovascular diseases, type 2 diabetes and some forms of cancer. Grain legumes also help to reduce the risk of obesity (Burstin et al., 2011). They play a vital role in maintaining soil fertility by fixing atmospheric nitrogen. India, the largest producer of pulses over the world with 25% share in global pulse production is largely dependent on pulses that grow in rainfed areas. As a result, climate change is predicted to be more pronounced in these crops.

Climatic Constraints of Pulse Production

Shift in monsoon and erratic rainfall causes delayed sowing/transplanting of *Kharif* crops (e.g. late transplanting in *Kharif* Rice), for which the sowing of *Rabi* crops, such as pulses, also get delayed. Delayed sown crops face terminal heat and drought stress during its phenological growth period which reduces its potential yield, cause forced maturity without even completing the vegetative growth properly that ultimately hampers crop yield. Heat and drought are undoubtedly the two most important stresses having huge impact on growth and productivity of the crops. Increasing post-monsoon rainfall during the month of January and February act as detrimental factor for *Rabi* pulses particularly, during its reproductive period. Major pulses such as chickpea, pigeon pea, lentil grown under rainfed conditions are subjected to multiple stresses viz., drought, high and low temperatures, high solar radiation, salinity and

waterlogging. In order to cope up with these adverse abiotic factors, pulses have wide adaptive mechanisms such as very deep rooting system in pigeon pea and chickpea, high degree of dehydration tolerance, phenotypic plasticity, wide ranging sensitivity towards photo thermo periods and higher moisture retention capacity.

Pulses Diseases

The major pulse diseases are anthracnose (*Collectrotrichum lindemuthianum*), dry root rot (*Rhizoctonia bataticola*), Alternaria leaf spot (*Alternaria alternata*), Wilts (*Fusarium* spp.), phytophthora blight (*Phytophthora cajani*), MYMV and leaf crinkle. Stem rot (*Sclerotium rolfsii*) resistance in groundnut is temperature-dependent. Dry root rot (*Rhizoctonia bataticola*) in chickpea and charcoal rot (*Macrophomina phaseolina*) increased many folds due to high temperature and prolonged moisture stress. Prolonged moisture may create a new scenario of potential diseases in such as anthracnose, collar rot, wet root rot and stunt diseases in chickpea; Phytophthora blight and Alternaria blight in pigeonpea, leaf spots and rusts in groundnut indicated that outbreak of Phytophthora blight of pigeonpea (*Phytophthora drechsleri* f. sp. *cajani*) in last 5 years may be attributed to high intermittent rain (>350 mm in 6–7 days) in July–August. The high temperature tolerant fungal and MYMV disease will be increased because favorable condition for increased the vectors will be occurred in future.

Pulses Pest

Global warming and climate change will influence activity, diversity, distribution and population dynamics of insect pests including the grain legumes. Several insect pests damage grain legume crops, of which the pod borer, *Helicoverpa armigera*; spotted pod borer, *Maruca vitrata*; spiny pod borer, *Etiella zinckenella*; pod fly, *Melanagromyza obtusa*; aphid, *Aphis craccivora*; defoliators, *Spodoptera litura* and *S. exigua*; thrips, *Megaleurothrips usitatus* and *Caliothrips indicus* and the bruchid, *Callasobruchus chinensis* cause extensive losses in grain legumes. The incidence and extent of losses due to these pests varies across seasons, locations, and cropping systems. The pest spectrum on grain legumes will change considerably due to impending global warming and climate change. The geographical distribution of some of the pests might extend to temperate regions in Europe and America, while the outbreaks of some other pests will become more frequent.

Several outbreaks of pod borer, *H. armigera* and spotted pod borer, *M. vitrata* have been recorded on grain legumes in India, which at times have resulted in complete crop loss. The scale insect, *Ceroplastodes cajani* in pigeonpea and beet armyworm, *Spodoptera exigua*, mealy bug, *Ferrisia virgata*, and white fly, *Bemisia tabaci* in chickpea have emerged as new pests; while leaf miner, *Porphyrosela neodoxa*, mealy bugs, *Drepanococcus cajani*, and *Coccidohystrix insolita* are some of the emerging pest problems in pigeonpea in India. In addition, there will be greater genotype x environment interactions for expression of resistance to insect pests, and this warrants a greater effort for identification of diverse sources of resistance and need for integrated pest management packages that will be effective under global warming and climate change.

Effect of Abiotic Stress for low productivity

Soil: Change in climate will affect the groundwater recharge, soil moisture, and frequency of drought or flood, and groundwater level in different areas. Increased soil temperature may also lead to an increase in autotrophic CO₂ losses from the soil caused by root respiration, root exudates, and fine-root turnover

Temperatures: High temperature and water deficit decrease net photosynthesis during the period of the constraint, resulting in a reduction of plant growth rate. The reproductive parts and grain-filling process are extremely sensitive to chilling and high temperature. The combined effect of heat and drought is more detrimental than effect of drought and heat alone, as a result productivity further decreases. Increasing temperature above 23°C results in a decrease in the rate of nitrogen remobilization from vegetative parts to growing seeds

(Pellissier et al. 2007; Ito et al. 2009). Lowering temperature from 23°C to 13°C with maintained radiation results in an increase in carbon assimilate availability allowing new vegetative sinks to grow. Day-time maximum air temperature beyond 40°C during reproductive phase in winter pulses results in complete failure of anthesis, pod setting and induces hardening of seeds. High temperature caused a reduction of 16% for grain set compared with the ambient control, whereas individual grain weight increased by 5% under high temperature. High temperature also caused a decrease in harvest index of 10%.

Water: There is now a great worry about a decline in soil fertility, raising salinity, change in the water table, degradation of irrigation water quality and resistance to many pesticides in north-western India.

Impact of climate change on nodulation : Below ground parameters (root growth, nodulation and plant-microbes interaction) responded variably with elevated CO₂ and elevated temperature. Elevated CO₂ increases carbon assimilation that had considerable effect on root morphology and architecture, symbiotic relationship with mycorrhizal fungi, modification in pH and redox potential in rhizosphere. Different experimental evidences reported 2–2.5 times more proteoid root and 3–3.5 cm more increase in lateral root in growth chamber under higher elevated CO₂ with sub-optimal dose of phosphorus. The OTC experiment by Srinivasarao *et al.* (2016) reported that, root biomass was higher by 27, 15, and 22% under 500 ppm and 56, 43 and 112% under 700 ppm of CO₂ than ambient condition in groundnut, blackgram and pigeonpea, respectively. Nodule number and biomass of several leguminous plant species, such as soybean, bean, field pea, alfa-alfa and lentil remarkably increased at elevated CO₂ exposure. Elevated CO₂ have favorable impact on root exudates secretion that significantly aided rhizobium to infect and colonise and form nodule.

Mitigation strategies

Agricultural practices that are more efficient can considerably reduce greenhouse gas emissions, which in turn will reduce the need for fertilizers, and pulses play an important role in this context. Along with the better management of fertilizers, including integrated nutrient management, better timing of fertilization and precision farming; pulses have a very important role to play in climate change mitigation. The inclusion of pulses in crop rotations utilizes symbiotic bacteria to fix nitrogen, which is partly transferred to subsequent crops, increasing their yields. An adaptation to the changing climate impacts the cultivation of pulses globally has been growing and mostly the grown pulses include dry pea, lentil and chickpea which are largely and globally grown in semi-arid areas. These pulse crops have been much preferred due to their suitability in responding differently in the growing season’s rainfall and temperature patterns as well pulses tend to increase cereal production when grown in rotation. In several regions pulses have been grown in rotation with maize, wheat and rice.

Pulses have been assuring global food security and enhancing the affordable attainment of protein among poor rural societies in which the level of protein contained in chickpea is estimated to be the same as the protein offered by meat. It is globally within the context of climate change; pulses have shown a promising role in meeting world protein demand and food security. Also, when intercropped or rotated, pulses have ensured the attainment of food varieties and increased soil productivity through nitrogen fixation. Chickpea are mostly preferred recently due to their ability of the root trait variability in stress tolerance. Under climate change impacts, pulses particularly chickpea and lentils respond positively as an outcome of fertilization effects due to elevated CO₂ related to the lowering of leaf stomata conductance and a decreasing rate of transpiration leading to enhanced water use efficiency. To respond to the impacts of climate change, the adaptation strategies have been developed in different areas including rainfed areas of central zone where one among them is the cultivation of chickpea which is heat tolerant with short maturity period.

A REVIEW OF THE EFFECT OF CLIMATE CHANGE AND VARIABILITY ON AGRICULTURE IN BANGLADESH

A K M KANAK PERVEZ*, MD. MOHIUDDIN SHEIKH, M. ARMANUL HAQUE, MD. ABU SAYEM AND UTTAM KUMAR KABIRAJ

Department of Agronomy and Agricultural Extension, University of Rajshahi, Rajshahi-6205, Bangladesh.

²Regional Agricultural Research Station, Bangladesh Agricultural Research Institute (BARI), Burirhat, Rangpur, Bangladesh

Department of Information Science and Library Management, University of Rajshahi, Rajshahi-6205, Bangladesh.

Additional Deputy Director (LR), Department of Agricultural Extension (DAE) & PhD Scholar (NATP), HSTU, Dinajpur, Bangladesh

Department of Agricultural Extension (DAE), Rajshahi, Bangladesh

Introduction

Intergovernmental Panel on Climate Change (IPCC) concluded that the climate system warming is unequivocal and observed the increase global average ocean temperature and average air, melting of the ice and snow, and rising sea level. Day by day, the impact of climate change is increasingly affecting agriculture worldwide as agriculture is susceptible to climate change and variability, particularly in respect of temperature, daylight, rainfall, and other extreme events in the weather. Crop yield reduction due to climate change is assessed under different climate models. For example, an increase of 1°C temperature can decrease the yield of 5-10 per cent of cereals (Lobell and Field, 2007; Hatfield et al., 2009). The higher temperature above 30°C damage the physical portions of the plant; when it is more than 37°C can destroy the storage quality of seeds (Wahid, 2007).

Climate change and variability in Bangladesh

Climate change also increases the intensity and probability of diseases, insects and weeds (Faurès et al. 2013). Climate change has been decreasing all significant crop yields in Bangladesh. An increase of 5.32°C temperature in 2100 in Bangladesh will reduce the yield of potato, rice, and wheat by nearly 38.6, 67.8, and 47.6 per cent, respectively (Rahman et al. 2018). In addition, the coastal area of Bangladesh is seriously affected by salinity intrusion. If the climate change impact on agriculture continues, soon Bangladesh will be unable to produce food for itself.

Bangladesh is often regarded as one of the most vulnerable countries to the effects of global warming and climate change. This is owing to its unusual geographical location, floodplain domination, low elevation above sea level, high human density, and excessive reliance on nature. It was rated eighth in the list of countries most affected by climate disasters from 1999 to 2018 in Germanwatch's Climate Risk Index for 2020. Crop cultivation in Bangladesh plays the most important role; on the other hand, it faces various obstacles each year. Between 1983 and 1996, Bangladesh lost roughly 1 million hectares of arable land.

A 4°C rise in temperature as a result of climate change will have a significant impact on food production in Bangladesh. Poor credit support to farmers, Unfair prices of produce, and insufficient research investment are among the significant challenges. The climate of Bangladesh has been divided into seven climatic sub-regions. Summers are becoming hotter, monsoons are becoming more irregular, and erratic rainfall in the dry season, resulting in water logging and landslides. Climate anomalies and their repercussions on Bangladesh were documented with high confidence in the IPCC's AR4 report.

Bangladesh's average annual temperatures are anticipated to climb from 1.0°C to 1.5°C by 2050 if no action is taken. The World Bank was one of the first development partners to assist Bangladesh after its independence. To combat climate change, the country must concentrate

on developing jobs outside of agriculture and strengthening its governance structures. Rainfall in Bangladesh ranges from 1527 mm in the west to 4197mm in the east, with a mean of 2488 mm. The rainfall gradient is roughly 7 mm /km from west to east.

Average yearly humidity fluctuated during the previous 57 years (1960-2017) when we examined the average humidity data. The average annual relative humidity varies from 78.5% to 80% from June to September. January through March are the least humid months in the eastern states, while April and May are the most humid. During the winter season, a centre of high cold pressure is created over the northern section of India. A chilly air stream rushes eastward from this high pressure, entering the country's northeast corner.

This is the part of South Asian subcontinent's winter monsoon circulation. During the summer season, an area of low pressure develops over the west-central part of India and warm, moist air from the Bay of Bengal flows through Bangladesh. As a result, during the summer, the prevailing wind direction in Bangladesh is generally southerly (south, southwest or southeast).

Impacts of Climate Change on Agriculture in Bangladesh

The impact of climate change is a significant concern for Bangladesh, where lives and livelihoods depend mainly on agriculture. Incidences of floods, droughts, high temperatures, flash floods and floods, etc., are predicted to be more frequent and intense. Agricultural productivity depends on climatic factors like temperature, rainfall, light intensity, radiation, and sunshine duration, which are very erratic. Temperature and rainfall fluctuations have affected crop production in many parts of Bangladesh. A 4°C increase will occur due to climate change, resulting in a severe impact on food production in Bangladesh.

Climate change generates irregular and heavy rainfall and flood and flash flood severity and frequency in Bangladesh. Salinity levels are rising, resulting in a significant lack of irrigation water for rice production. Sea level rise cause inundation of more area, which scientist have already reported. Damage to crops will be more in future (MoEF, 2020).

Adaptation/Mitigation Strategies

The government established the Climate Change Unit (CCU) in June 2010 as a node inside the Ministry of Environment and Forests (MoEF), administering the MoEF's budget for climate-related initiatives and providing technical and subject-matter support. The CCU is also incharge of administering finances connected to climate change, creating connections amongst sectoral organizations, and generating an information base for NGO activities on climate change-related topics. The GoB has also established the following funds to carry out the aims and initiatives outlined in NAPA (The National Adaptation Programme of Action 2005) and BCCSAP (Bangladesh Climate Change Strategy and Action Plan 2009): Adaptive crop agriculture includes innovative farming practices in the Haor Basin and Coastal Zones, crop Insurance as a risk management strategy, climate change, gender and vulnerable groups. According to a study, Bangladeshi farmers gradually shift from climate-sensitive crops to climate-insensitive ones. Farmers are also practicing integrated farming systems where they raise animals, fish, and many types of crops on the same piece of land.

Conclusion

Climate change adaptation through crop switching can play an essential role in ensuring food security in the country. IPCC estimates that by 2050, rice production in Bangladesh could decline by 8% and wheat by 32%. Therefore, crops and varieties adapting to climate change should be emphasized. Public awareness is also important in respect of impacts climate change and adaptation mechanisms. However, planning, policy formulation, and implement adaptation strategies for climate change are still developing in Bangladesh.

References

Faurès, J. M., Bartley, D., Bazza, M., Burke, J., Hoogeveen, J., Soto, D., & Steduto, P. (2013). Climate smart agriculture sourcebook. FAO, Rome, 557.

Ministry of Environment and Forest (MoEF, 2020). Bangladesh Climate change Strategy Action

Rahman, A., Mojid, M. A., & Banu, S. (2018). Climate change impact assessment on three major crops in the north-central region of Bangladesh using DSSAT. International Journal of Agricultural and Biological Engineering, 11(4), 135-143.

Wahid, A., Gelani, S., Ashraf, M. & Foolad, M. 2007. Heat tolerance in plants: an overview. Environmental and Experimental body. Vol. 61. Issue 3. pp 199-223.

INFORMATION COMMUNICATION TECHNOLOGY FOR TRANSFER OF TECHNOLOGY IN AGRICULTURE – A WAY FORWARD

RAJESHWARI N*, PRAVEEN R SHINDHE, SUREKHA SANKANAGOUDAR, RAGINI MODI AND SPOORTHI K N

Department of Extension and Communication Management, College of Community Science, UAS, Dharwad. -580005.

ABSTRACT

Agriculture continues to be the most important sector of Indian Economy. Research, extension and farmers efforts have all contributed significantly to increase in food production. Agricultural extension in India has evolved through different phases from Community Development Programme in 1952 through Training and Visit system in 1970's & the recent Agricultural Technology Management Agency (ATMA) which emphasizes on involvement of all stakeholders in the production process. But seeing into the constraints of Human resource changing technologies & reforms in IT sector. IT enabled extension services is slowly gaining importance in wake of the Telecom revolution in order to speed up the delivery of the agricultural advisory services. The initiatives have come from the Central Government, State Government, Corporate sector, NGO's & Private Agencies. According of Telephone Regulatory Authority of India (2017), there are 431.21million internet users in India & slowly the rural sector is catching up from 48 million users in 2012 to 371 million mobile internet users at present. e-Sagu' which was implemented in 2004-05 aimed to develop a model for providing personalized agricultural advice to farmers for major crops such as paddy, cotton, maize, chilli, castor, red gram, ground-nut. An Information and Communication Technology (ICT) based extension model called 'e-Velanmai' (means e-agriculture) for dissemination of farm specific agricultural technologies from the agricultural scientists to the needed farmers was initiated in the selected command areas of Tamil Nadu state. e- Sap has been successfully built & tested and deployed by UAS, Raichur in association with Tene agriculture solution pvt.ltd, Bangalore. e- SAP is novel ICT platform and dedicated field device capable of making two way exchange of information in real time. ICT system dedicated for crop health management. Insect pests, microbial diseases, nutritional deficiencies and weed problems. It enumerates different species of natural enemies, which has gained importance during recent times. There is provision to capture the history of plant protection measures that have previously been adopted by the farmer while raising the current crop.

Key Words – e- Sagu, e- Velanmai and e- SAP

DIVERSIFICATION OF AGRICULTURE ON FOOD, NUTRITION AND HEALTH SECURITY

VIJAYAKHADER,

Faculty of Home Science, Former Dean, Acharya N.G. Ranga Agricultural University, Rajendranagar, Hyderabad-500030, India

Intervention of various viable technologies to improve the food & nutritional status of the population proved the following facts: Promotion of malt based small scale food provides opportunity for rural women to develop entrepreneurship and employment. It also provides food and nutritional security through additional income. Several technologies like value addition to fish & prawn products, artificial pearl culture, processing of salted fish were developed under National Agricultural Technological Project which helped the self-help group women of Andhra Pradesh, Karnataka, Kerala and Tamil Nadu to improve their economic status. Received two patents for fabricating *I) Low Cost Ice Cream Freezer* (to prepare ice cream with small quantity of milk in rural area) *and II) Fresh Fish Vending and Display Table* (which helped the fisher women to reduce their drudgery and also preserve the fresh fish for a longer time without getting spoiled) The technology was licensed twice. Food Product development can be taken as an income generating activity in the rural areas by the illiterate women which can be included in supplementary feeding programs mainly to improve the nutritional status of the children .The horse gram which is commonly used for cattle feed can be diversified for human consumption with less investment. Mothers as well as Anganwadi workers preferred amylase rich supplementary foods preferred as these supplementary foods better as compared to earlier supplied food i.e. *ready to eat food*. Introducing red palm oil is beneficial to overcome vitamin A deficiency. The supplementary income of women has a positive impact on the nutritional status of the family.

Keywords: Technology Intervention, Nutrition Security, Health Security and Economic Empowerment.

Introduction: Food processing has huge potential to improve rural livelihoods by raising farm income through value addition in agricultural produce. Rural employment opportunities should be increased by promoting post-harvest opportunities and value addition, entrepreneurship at the village level and this will increase the net income of the farmers. The promotion of agriculture, small scale rural industry, the rural economy gets a big boost and also corrects the rural- urban imbalance and prevents migration.

Methodology: Surveys, Chemical analysis, Biochemical estimations, Product development, value addition, bio-availability studies on rats as well as human subjects; clinical observations were used as per the study design.

Results:

Research carried by Vijaya khader on impact of diversification of agriculture on food, nutrition and health security is discussed under *Diversification of Agriculture; Horticulture; Mushrooms; Fisheries; Value addition and Economic Empowerment of Women*

A) Crop diversification / cropping systems:

Intercropping of ragi and red gram in 8:2 ratio gave additional income of Rs.5, 500/- ha compared to single crop of ragi. Ground nut intercropped with either red gram or castor in 7:1 ration recorded maximum. Red gram based cropping systems with cluster bean in 1:7 ratio gave highest. Among different alternate crops tried to groundnut during late rabi, black gram recorded maximum net returns (Rs.26801 /ha) and followed by sesasum (Rs.20697 /ha). Cluster bean and field bean are excellent alternative crops for rain fed crops.

B) Horticulture intervention:

This focused on increasing the supply of micronutrient rich crops through the promotion of home gardening or Nutrition Garden. Horticulture intervention will involve the Ministry of Agriculture for the supply of *seeds, extension services, and storage support*. Vitamin A and Iron Nutritional status of nutritionally vulnerable segments of population subsisting on Horticulture crops and dairy farming in East Godavari district of A.P.(Aruna,1997) showed very significant improvement in their nutritional status. Significant impact of Nutrition Garden / Home garden reflected on Iron & Vitamin status of the families under study.

Operational feasibility of Red Palm Oil (RPO): Vitamin A deficiency causes many health problems especially among children. A study was undertaken to screen the effect of supplementation of RPO obtained from the fruits of tree *Leis guineensis Jac*.The oil is rich in B-carotene, a precursor of Vitamin A .Supplementation of crude RPO to Anganwadi Children increased the attendance of children, increase in heights and weights of children was observed. Decrease in Grade 1V and Grade 111 malnutrition was also observed in boys as well as girls (Vijayakhader and Aruna, 2008) .

C) Mushroom cultivation:

Every woman is an entrepreneur as she manages, organizes and assures responsibility for running her house. It has been increasingly realized that women possess entrepreneurial talent which can be harnessed to create employment opportunities. In the rural areas a woman can easily manage 4-10 beds depending on the space available, helping them to earn Rs.180 to Rs.450 per month. The results revealed that *spawn multiplication can be done by women as a co-operative venture and mushroom cultivation can be undertaken at household level as an income-generating activity*(Vijaya Khader, 1994) .

D) Studies on Intervention of Fisheries:

To elicit the information on the food consumption of preschool children population of 2203 (1072♂:1131♀) were selected in the 28 coastal villages of 13 districts spread over 4 states viz. Andhra Pradesh, Karnataka, Kerala and Tamil Nadu with a total of 5744 Households. A detail information on the food consumed, frequency and amount purchased were noted and the total amounts of each food consumed for a period of one month was noted. This was divided by per Consumption unit (C.U.) to get the food consumption / C.U. / day.24 hour recall method combined with one day weighment was employed to assess the nutritional status of preschool children (1-5years). The purpose of diet survey was explained thoroughly. i.e., food items served in plate before eating. The cooked ingredients were measured through cups and were then converted to raw ingredients.

Fisher women in Coastal Eco-System of Andhra Pradesh, Karnataka, Kerala and Tamil Nadu. (Vijaya Khader, R.Sathiadas and H.Mohamad Kasim , 2005) reveal fish eaters in the study area comprise 47 per cent of the total population ranging from 23.7 per cent in Tamil Nadu to 85 per cent in Kerala. Though the position of Tamil Nadu is high in terms of number of coastal districts and possession of coast line including the number of landing centers, the number of fish eaters in the state is minimal. *Andhra Pradesh employs 32 per cent of its fisherwomen in fish curing/drying/net making and 27 per cent in processing plant works.*

Two Equipments namely *I) Low-Cost Ice Cream Freezer, II) Fresh Fish Vending and Display Table* have been fabricated and received Patents and the technology was licensed to a woman entrepreneur for manufacturing these two equipments for a period of two years (Vijaya Khader, et.al. 2004) . After expiry of two years the technology on low cost ice cream freezer was licensed second time to other women for a period of 6

years. *These equipments were fabricated mainly to improve the Health & Nutrition Security.*

Nutritional status of preschool children in coastal fishing villages of South India Andhra Pradesh, Karnataka, Kerala and Tamil Nadu: The consumption of vegetables, fruits was found to be low, milk consumption was fairly low among the preschool children & fish consumption was found to be 34 gm/ CU. The intake of nutrients in case of preschool children was found to be less than the RDA. It was observed that macro nutrient intake was fairly better when compared to the micro nutrient intake .31 % of preschool children were anemic. The other clinical symptoms like angular stomatitis, chelosis & dryness of skin were 35 % on an average .The reason for high anemic might be due to low consumption of iron rich foods, poor health ,hygiene & sanitation and also might be due to lack of nutritional awareness (Vijayakhader, et.al, 2005)

Success Stories:

The National Agricultural Technology Project entitled **Studies on Fisherwomen in coastal ecosystem of Andhra Pradesh, Karnataka, Tamilnadu and Kerala** explored the socio-economic status of fisherwomen and found the families wherein women are actively involved in one or other occupation has flourished and achieved all round development. *Seven Fisherwomen (3 from Kerala ;2 from Karnataka and 2 from A.P) have attained the Training and Awareness from National Agricultural Technology Project, implemented in their places and enhanced their socio-economic status through various skill oriented training programmes and continuous day-to-day discussions with the Scientists.*

E) Value addition:

- 1) **Low-cost energy protein rich preparations using Horse gram:** The horse gram which is commonly used for cattle feed can be diversified for human consumption with less investment. Processed horse gram flour was prepared using Puffing and Roasting, Processed Soya bean flour was prepared by Dehulling and Roasting. The low cost energy protein rich products namely RAGINA and EPRF were prepared using the simple home scale processing methods like germination, roasting and puffing, to improve the nutritional status. Horse gram has been identified as potential food resource for the tropics and also occupies an important place among pulses because of its ability to resist severe drought conditions. Soya bean (*Glycine max*) is one of the best vegetable proteins and has tremendous potential to meet the protein deficiency in the cereal based Indian Diets at a low cost. Product development can be taken as income generating activity in the rural areas by the illiterate women. Products can be included in supplementary feeding programs in order to improve the nutritional status of the vulnerable groups of the population (Vijayakhader & P. Ashlesh, 1998)
- 2) **Effect of feeding malted food on the nutritional status of vulnerable groups (Vijayakhader & Umamaheswari, 2012)** Amylase Rich Malted Mixes (ARMM) two types were formulated using Ragi / Wheat and suitable products namely *Laddu, Roti, Kheer, and Porridge* were prepared using formulated malted mix. The ARMM's found to be nutritional dense. For the supplementation of malted mixes 8 villages of Lepakshi Mandal, Ananthapur District was selected. Preschool children (400), pregnant women (100) and Lactating women (100) were selected and fed with two types of malted mixes (Ragi / Wheat) for a period of 3 months. Anthropometric data, Food intake showed a significant increase in the preschoolers, pregnant women and Lactating mothers. Clinical assessment showed considerable

reduction i.e. (50%) in nutritional deficiency symptoms and morbidity rate of all the subjects. Training programmes were conducted to 40 members by lecture and method demonstrations using developed education material such as Posters, Flip book, Manual and CD-Rom. After the training 60-70% improvement was observed in Knowledge, Attitude and Practices scores of the trainees, project profile for bulk production was also developed. Supplementation of ARMM’s helped to improve the nutritional status of the vulnerable groups of population in rural areas especially with regard to *protein, energy, iron, and calcium and B-complex vitamins*. Promotion of malt based small scale food industry not only provides opportunity for rural women to *develop entrepreneurship and employment but also provided Food and Nutritional Security through income generation*.

- 3) **Therapeutic food supplementation in ICDS projects of Andhra Pradesh (Yasoda Devi & Vijayakhader, 2004)** Total 2267 children of age range of 1-3 years were selected (892 children from rural ICDS project, Saravakota; 507 children from new ICDS project, Kottam; and 778 children from tribal ICDS project, Seethapeta) for a period of 1 year. The three types of supplements were prepared and distributed by A.P. Foods, Hyderabad. The supplements were distributed either in the form of Laddu or as in the form of powder. Nutritive value of 100g of supplements provides 400 to 480 Kcal 12.5 to 13.8 g proteins. It was very encouraging to note that **92% of grade III children showed improvement in their weight and height; 80% of moderately malnourished; 42% of mildly malnourished and 44% with normal grade showed improvement**. It was also observed that there was positive correlation between the calorie and protein intake and also improvement in weight and height. All 100% of mothers as well as Anganwadi workers preferred these supplementary foods better as compared to earlier supplied food i.e. ready to eat food.

F) Economic Empowerment Of women:

Family income and nutritional status of pre-scholars’ in rural areas of Tenali division (Vijayakhader & Kavitha, 1993) The increase in the annual per capita income of the family increased slightly the nutritional status of pre-scholars. The results also reveal that no significant difference was observed between the body weight of children and income of the parents in all the age group. In spite of having high purchasing power, **lower educational status of the mothers** and also low nutritional awareness, majority of the children are in Grade 1 degree malnutrition.

Impact of women’s supplementary income on families’ nutritional status (Vijaya Khader, 1999)

The study was carried in 4 villages of Rajendarnagar Mandal & Ranga Reddy District on vegetable venders, Shop Keepers, Washers, Fruit venders, Tea & Snack Venders. The results reveal that the supplementary income of women has a positive impact on food & nutrient intake of the family.

Conclusion: The impact of intervention of various viable *technologies improved the food & Nutrient intake of the family contributing towards Food & Nutrition security*.

Acknowledgments: Sincere thanks to World Bank, ICAR, NATP, ICMR, DBT and ANGRAU for their financial support.

References:

- Aruna, A. 1997. Significant Impact of Nutrition Garden /Home Garden reflected on Iron & Vitamin status of the rural families. PhD Thesis)
- Vijaya Khader, R. Sathiadhas and H. Mohammad Kasim. 2005. Role of Women in Fisheries in Coastal Eco-System of Andhra Pradesh, Karnataka, Kerala and Tamil Nadu; J. Res. ANGRAU 33 (1) pp. 53-59
- Vijaya Khader, R.N. Kumar, J.Lakshmi, K.DhanapaH.M.Kasim,R.Sathiadas and N. S. Sudhaka.2004 .Studies on Fisher Women in the Coastal Eco System of Andhra Pradesh, Karnataka, Kerala and Tamil Nadu ,World Fish centre, Global Symposium on Gender and Fisheries Seventh Asian Fisheries forum,P.No.69-79, Penang, Malaysia
- Vijayakhader & P. Ashlesh.1998. Home-based low-cost energy protein rich preparations using Horse gram (*Dolichos Biflorus*) for vulnerable groups. Indian Oil Palm Journal, Vol.VIII, No.46, pp.13-17
- Vijayakhader & K.Umamaheswari .2012. to study the effect of feeding malted food on the nutritional status of vulnerable groups: accepted for publication in the International Journal for Biotechnology and Molecular Biology Research.Vol.4(4) pp.35-36
- Vijaya Khader .1994. Rural Women as Entrepreneurs in Mushroom Cultivation, Indian Farming, March,pp. 18-21
- Vijayakhader and Kavitha 1993. Anthropometric measurements of pre-school children in the rural areas of Tenali division. Asian Journal of Psychology and Education. Vol.26 No.1-2, PP.35-40.
- Vijaya Khader 1999. Impact of Women’s supplementary incomes as families’ Nutritional status. The Indian Journal Social Work, vol. 60 (3) pp.368-378.
- Vijayakhader and K. Aruna 2008. Operational feasibility of RPO supplementation to pre-school children in Anganwadi centers of ICDS Project, Natural Product Radiance, and Vol.7 (4) pp 310-313.
- Yasoda Devi P. & Vijayakhader 2004. Therapeutic food supplementation in ICDS projects of Andhra Pradesh, Every man’s science Vol.39 (3) pp.160-167

SPATIO-TEMPORAL DISTRIBUTION OF DENGUE VECTOR AND ITS VULNERABILITY USING GIS: A CASE STUDY OF JAIPUR CITY, INDIA

#PRAVEEN KUMAR RAI¹, PRIYANKA ROY², SURAJ KUMAR SINGH², SHRUTI SINGH²

¹Department of Geography, KMC Language University, Lucknow, U.P., India

²Centre for Climate Change and Water Research, Suresh Gyan Vihar University, Jaipur, Rajasthan, India

ABSTRACT

Vector-borne diseases (VBD) like Malaria, Dengue, Japanese encephalitis (JE), Kala-azar, Lymphatic Filariasis, and Chikungunya are common in India. There are many different kinds of vectors, such as mosquitoes, aquatic snails, blackflies, fleas, lice, sandflies, ticks, etc. most of these vectors are common in India. India is a tropical country, which makes it a good place for pathogens and parasites to grow and spread and for vectors to live. One of the characteristics that aid in vertical disease transmission is population distribution and makeup. Individuals and governments alike pay a high price for vector-borne illnesses. Individuals and their families may incur costs such as the purchase of treatments and preventive measures, missed work days, and funeral costs in the event of death. The supply and staffing of health facilities, public health initiatives, and missed possibilities for economic growth and tourism are all costs to governments. The city of Jaipur is a major tourist destination, with a constant growth rate of 3% and a population density of 6,500 people per square kilometre, as per latest surveys (Indian

Census web site). Henceforth, this study was to assess the vulnerability of the urban Jaipur population to dengue virus infection. The proximity and exposure, to vector habitat and climatic parameters such as temperature and precipitation were evaluated and assimilation of aspects of vulnerability the (total population, ward wise population density, Literacy rate, social and cultural practises, waste management) as significant factors ambulating weightage for vulnerability indicators. The total population of the urban Jaipur depicts span of people that might fall prey to dengue infection, the density of population portrays the rate of vertical transmission of the virus among the populace, literacy rate displays that the high education relates to the awareness for precaution and technique to control vector breeding and transmission, working class population depicts the exposure to viral transmission. Along with these paradigm vector prevalence and habitat directly relates to the Dengue Virus Transmission consequently exposing large share of vulnerable urban population.

Based on assimilation of all the determining factors the outcome of the study depicts that the dense populace areas. The male population contributes to 67% of the total dengue cases where as only 33 % of female population, of which the 15 to 24 age group manifest the dengue virus infection in both male and female population. This dengue cases reports are cyclic in nature with the precipitation and temperature ranging between 25 to 30degree. The entire north and north-western area of the urban Jaipur is Vulnerable to dengue during monsoon and post monsoon season.

Key words: GIS, Vector Born Disease, Dengue, Remote Sensing, Jaipur.

DESIGNING OF INTEGRATED FARMING SYSTEMS USING MULTI-CRITERIA DECISION MAKING AND OPTIMIZATION METHODOLOGY FOR SUSTAINABLE DEVELOPMENT OF SMALL AND MARGINAL FARMERS OF ASIA

U.K. BEHERA¹, PRATISHRUTI BEHERA² AND BUSSA BHARGAVI³,
College of Agriculture, Central Agricultural University, Kyrdemkulai, Meghalaya-793105
² Department of Agronomy, Assam Agriculture University, Jorhat-785013, Assam
³ Scientist, Division of Agronomy, Indian Council of Agricultural Research (ICAR)- Central Institute for Cotton Research, Nagpur 440010, India

In order to meet the multiple objectives of poverty reduction, food security, competitiveness and sustainability several researchers have recommended to adopt integrated farming systems (IFS). Integrated farming system is an approach in which different land-based enterprises viz. crop, live stock, mushroom, apiary, fishery etc. are integrated within the bio-physical and socio-economic situations taking farmers preference and goal in to consideration. Farming system research/IFS is considered as a powerful tool for management of vast natural and human resources in developing countries. This is a multi-disciplinary approach and very effective for solving the problems of small and marginal farmers (Gangwar, 1993). Under the gradual shrinking of land holding in India and other developing countries, it is necessary to go for IFS to make farming more profitable and sustainable.

In agricultural research and development activities in India and other developing countries, the major emphasis is given to component and commodity based research projects involving developing animal breed, farm implement, crop variety and farm machinery, mostly conducted in isolation and at the institute. This component, commodity and discipline-based research have proved largely inadequate in addressing the multifarious problems of small farmers (Jha, 2003). Due to this, there has been a demand for holistic approach for technology generation and dissemination instead of

traditional component approach in piecemeal and isolation. However, mechanisms are lacking to provide the whole farm picture or model of outcome of the farm activities before the farmers taking into consideration of various farm resources, viz. land, labour, capital, management; constraints, viz. physical, bio-physical, ecological, socio-economic etc.; and enterprise combinations in IFS perspectives, viz. crop, dairy, fishery, poultry, apiary, mushroom etc.

Providing such a picture in the context of a farm or village or a region is a tedious process and difficult to calculate by human mind since number of factors are involved. Such problems can be overcome by the bio-economic modelling approaches.

The research in integrated farming systems (IFS) for the last few decades reveals that the enterprise planning and implementation are usually in component approach and in isolation, needs scientific and systematic approach. In this situation, optimization techniques are useful for resource allocation and designing of IFS in a scientific basis (Mahapatra and Behera, 2004). Farming system studies involving a number of enterprises and taking the physical, socio-economic and bio-physical environments into consideration are complicated, expensive and time-consuming (Mahapatra and Behera, 2004). There exists a chain of interactions among the components within the farming systems, and it becomes difficult to deal with such inter-linking complex systems manually. This is one of the reasons for slow progress in the field of farming systems research in India and elsewhere (Jha, 2003). This problem could be overcome by construction and application of suitable whole farm models (Dent, 1990). On the other hand, optimization techniques such as linear programming, goal programming and compromise programming proved useful for efficient resource allocation under various constraints (Taha, 2005). Optimization models optimize the use of farm resources, and can analyse farm response to policy change in an effective way (Loucks *et al.*, 1981). Among available, linear programming (LP) is one of the most applied solution methodology in agricultural planning to determine the optimal policy (Loucks *et al.*, 1981) in single and multiple objective framework. In this paper different bio-economic modelling techniques, which can help for optimal combination of the enterprises within the farming systems by taking farmers single and multi-objectives into consideration as well as an advanced modelling tool “MODAM” which has potentiality to integrate the environment and ecological goal with economic goal in the context of a farm/society or region are discussed briefly.

Integrated farming systems in single objective frame work

Decision making is the most important aspect of any business and industry. Farming is a business and agriculture is also an industry. Hence, decision making plays an important role with regard to the problems concerning production of commodities. The main questions before the producer or the production manager/farmer are: (i) What to produce, (ii) How to produce, and (iii) How much to produce. In an integrated farming system, farmers face the similar problems with respect to production of different commodities/enterprises at the farm level.

Linear programming is a modelling tool that can assist in the solution of many problems in agriculture. In particular linear programming is useful in selecting the best alternative from a number of available courses of action. LP model are designed to “optimize” a specific objective criterion subject to a set of constraints, the quality of the resulting solution depends on the completeness of the model in representing the real system.

Integrated farming systems in multi-objectives frame work

In real world IFS situations farmers face the difficulty of considering several objectives simultaneously, which are conflicting in nature such as farm return, capital requirement and labour employment. In addition farmers like to produce enough food for the farm family by utilizing his resources effectively including land. For this, compromise programming method

can be effectively employed for achieving a practical and compromise solution in such situation (Behera *et al.*, 2008).

In the traditional mathematical programming approach to modeling agricultural decision making, the decision maker seeks to optimize a well-defined single objective. In reality, this is not always the case as the decision maker is often seeking an optimal compromise among several objectives, many of which can be in conflict, or trying to achieve satisfying levels of his goals (Romeo & Rehman 1989). Two multi-criteria programming techniques, goal programming and compromise programming (both variants of linear programming), were used in a study of small-scale dairy farms in central Mexico by Val-Arreola *et al.* (2006). Compromise Programming (CP) is used to provide more insight into the problem which caters multiobjective needs of the farmers. Linear and nonlinear programming methodologies can be employed in CP environment to draw different scenarios’ for comparison. This enables in developing holistic model. Compromise Programming methodology has been demonstrated for designing integrated farming system (Behera *et al.*, 2008).

Multi-objective decision support tool for agro-ecosystem management (MODAM)

There is a need for a modelling tool to analyse agricultural sustainability as a combination of economic and ecological objectives. This model should be able to: (i) simulate effects of political and economic conditions on decisions about agricultural land use at farm level; (ii) screen current and new production technologies in a standardised form and show their effects on defined indicators of sustainability; and (iii) allow economic and ecological evaluation of production techniques at regional scale, including trade-offs among ecological and economic goals with respect to one farm or to a group of several farm types (regional approach).

Keeping above aspects in to considerations, a powerful bio-economic modelling tool was developed at ZALF, Germany (Zander and Kachele, 1999) which has the potentiality to simulate/combine/integrate various aspects of farming systems for agricultural decisions of economic and environment consequences due to certain level of management. In the bio-economic model MODAM, several farms are aggregated to regional model to evaluate the effects of different protection strategies and the methodology of developing region-farms. The model makes highly detailed studies and is used for verification of the economic aspects of the farm which is linked to the regional level. Model allows to draw different scenarios of agronomic and ecological and political decision making.

In summary, MODAM is an interactive modelling system, generating trade-off functions between ecological and economic objectives and helpful from the points of view: (i) interactive experimentation with the model increases knowledge and understanding of the behaviour of the real system, but also the understanding of conflicting positions of interest groups in land use ; (ii) it allows analysis of the maximum goal achievement possible under given conditions and, hence, defines the boundaries of the multidimensional solution space ; (iii) trade-off functions will show areas where a small decreases in achievement of the goal leads to much large realisation for another goal; this will allow simplification of the bargaining procedure by showing the consequences changing preferences: movement of indifference curve and new transaction ; (iv) sensitivity analysis of the model will show where further research is necessary ; and (v) scenarios of different conditions will help political decision makers to identify the most efficient instruments to realise the desired goal achievement in practise. The model, therefore is useful tool in an interactive procedure for the definition of sustainability criteria.

Description of the model

The Model show hierarchical linkage between the economic and ecological parts of the model. Where maps in the geographical information system (GIS) are available, the result of the model

in the form of crop rotations and their technical, economic, and ecological coefficients can be transferred to the GIS for the graphical presentations.

The structure of the model

The complexity of the selected system leads to a hierarchical structure of the economic and ecological modules that can also be applied to derive optimal solutions, if all possibilities are taken into accounts (Wossink *et al.*, 1992). The model is based on the multiple goal linear programming approach. It consists of five levels of the hierarchically linked modules. The first level of the modules generates the technical coefficients. The second level calculates the economic coefficients of site-specific production techniques. The third evaluates the ecological effects of these production techniques, and the fourth generates the linear programming model. The fifth level of models starts the subprogram which solves the equation system, analyses the results and prepares the transfer of data to the Geographical Information System (Fig. 1).

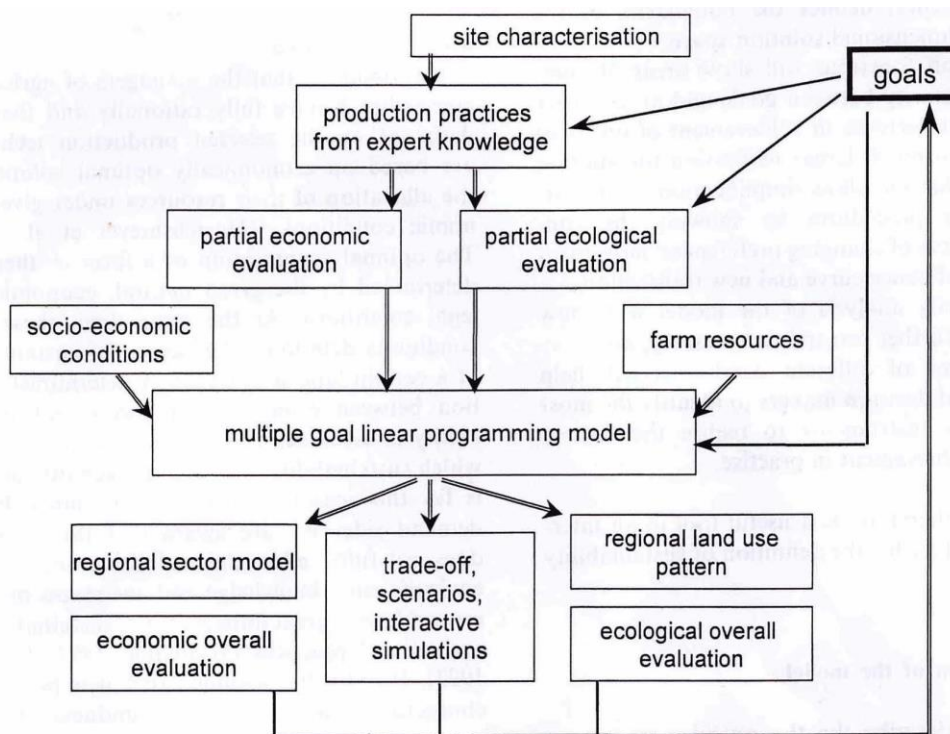

Fig.1. Iterative definition of goals in the modules of MODAM

Conclusion

In extension and developmental programmes in most of the developing countries, the respective agencies generally go to farmers and give a variety of advice in an ad hoc manner. A few appears to put a clear-cut whole farm scenario forward for consideration. In the context of present challenges to make small farms profitable not only in India, but also in most of the Asian and other developing countries, it is necessary to place an overall scenario for farm income and employment generation and other associated benefits before the farmers in village, regional and country level in order to motivate them towards farming. Placing such pictures before farmers will aid their confidence to adopt new technologies in an integrated manner for enhancing farm income and sustainability, thereby helping to improve the livelihoods of the farmers. Research programme must acknowledge current concerns on poverty elimination, food security, environment, equity gender and sustainability. Bio-economic modelling

methodology can prove as a potential approach for providing the whole farm picture by considering economic and ecological consequences. The modelling system, MODAM, is suitable for interactive research on multi-objective land use issues. MODAM is an instrument that can serve to mediate in conflicts among competing groups of land uses, by generating information about economic and ecological effects of the particular decisions. The modular structure permits linkage of additional economic and ecological modules and facilitates inclusion of the new scientific knowledge. This will be useful for interdisciplinary research.

References

- Behera, U.K., Yates, C.M., Kebreab, E. and France, J. 2008. Farming systems methodology for efficient resource management at the farm level: an Indian perspective. *Journal of Agricultural Sciences, Cambridge* 146:493-505
- Dent, J. B. 1990. *Systems Theory Applied to Agriculture and the Food Chain*. Amsterdam: Elsevier.
- Gangwar, B. (1993). Farming systems research for accelerating agricultural development in less developed countries – A Review. *Agricultural Reviews*. **14**(3):149-159.
- Jha, D. 2003. An overview of farming systems research in India. *Ann. Agric. Res.* 24, 695-706.
- Loucks, D. P., Stedinger, J. R., and Haith, D. A. 1981. *Water Resources Systems Planning and Analysis*, Prentice-Hall, Englewood Cliffs, New Jersey.
- Mahapatra, I.C. and Behera, U.K. 2004. Methodologies of farming systems research. (Panda, D., Sasmal, S., Nayak, S.K., Singh, D.P. and Saha, S., editors 2004. “Recent advances in Rice-based Farming systems”, 17-19 November, 2004, Cuttack, Orissa, Central Rice Research Institute. pp79-113.
- Romero, C. and Rehman, T. 1989. *Multiple Criteria Analysis for Agricultural Decisions*. Amsterdam: Elsevier.
- Taha, H.A. 2005. *Operations Research: An Introduction*, Prentice- Hall of India Private Limited, New Delhi.
- Val-Arreola, D., Kebreab, E. and France, J. 2006. Modeling small-scale dairy farms in central Mexico using multi-criteria programming. *Journal of Dairy Science* 89:1662-1672.
- Wossink, G.A.A., de Koeijer, T.J. and. Renkema, J.A. 1992. Environmental-economic assessment: a farm economic approach. *Agricultural Systems* 39: 421-438.
- Zander, P. and Kachele, H. 1999. Modelling multiple objectives of land use for sustainable development. *Agriculture Systems* **59**: 311-325.

NANOTECHNOLOGY IN WASTEWATER MANAGEMENT: A NEW PARADIGM FOR WASTEWATER TREATMENT

SHANKRAMMA K

School of Life Science’s, JSS AHER (Deemed to be University), Mysore-570015, India

ABSTRACT

Clean and safe water is a basic human requirement for the multifaceted development of society and a thriving economy. Rapid population growth, expanding industrialization, urbanisation, and extensive agricultural practises have resulted in the generation of wastewater, which has rendered the water not only dirty or polluted, but also lethal. Every year, millions of people die as a result of diseases transmitted through the consumption of contaminated water. Although various methods for wastewater treatment have been investigated in recent decades, their use is limited by a number of constraints, including the use of chemicals, the formation of disinfection by-products, time consumption, and cost. Nanotechnology, defined as the manipulation of matter at the molecular or atomic level in order to create new structures, devices, and systems with superior electronic, optical, magnetic, conductive, and mechanical properties, is emerging as a promising technology that has demonstrated remarkable feats in a variety of fields, including wastewater treatment. Nanomaterials have a high surface-to-volume ratio, high sensitivity and reactivity, high adsorption capacity, and ease of functionalization, making them ideal for wastewater treatment. We reviewed the techniques being developed for wastewater treatment using nanotechnology, including adsorption and biosorption, nanofiltration, photocatalysis, disinfection, and sensing technology. This extend talk, we will discuss the fate of nanomaterials in wastewater treatment, as well as the risks associated with their use.

UNDERSTANDING STRATEGIC WEED MANAGEMENT IN DIRECT SEEDED RICE - A REVIEW

R R UPASANI* AND SHEELA BARLA**

Department of Agronomy, Birsa Agricultural University, Ranchi- 834006

Rice (*Oryza sativa* L.) is one of the world’s most important staple food crops. It is the primary source of income and employment for the majority of the population in Asia in general and India in particular. Rice has wider climatic adaptability, under both the lower and upper limits of climatic variables with average growing temperature (17–33 °C), annual rainfall (100–5100 mm), and solar radiation (25–95% of potential) during the main rice season (Zhao, 2006) grows well all over the world ranging from the flood plains of Bangladesh to the Himalayan foothills of Nepal, and from the rain forests of Indonesia to the desert plains of Australia (IRRI, 1995; Maclean et al., 2002; Kumar and Ladha, 2011) covering nearly 161 million hectares (m ha) in 114 countries. Asia alone contributes more than 90% of global production (143 m ha area; 612 m tons production) and consumption (FAO,2009) as it is the principal cereal food of the main diet of 3.5 billion people, and due to burgeoning population, there is still need of about 70% additional rice by 2025 (Kim and Krishnan, 2002).

Pros and cons of transplanted rice:

Transplanting in puddled soils (intensive tillage in ponded conditions) with continuous flooding is the most common method of rice crop establishment in Asia (Singh et al., 2006; Kumar and Ladha, 2011). However, the most important problem associated with transplanted rice is that change in soil aggregates and development of hardpan below the soil surface caused due to flooding and puddling, which is not desirable for following wheat crop. Although, this

is advantageous for effective weed control in the transplanted rice field (Bhagat et al., 1999; Kumar et al., 2008). The technique of flooding the field with water is not only very laborious, tidy, and cumbersome but also very expensive, and time-consuming (Timsina and Connor, 2001; Rajkumara et al., 2003; Soomro, 2004; Sahrawat et al., 2010). Manual transplanting of the seedling is often delayed because all fields are not transplanted simultaneously, thus the seedling age surpasses that of optimum age of 21 to 25 days thus fewer tillers develop reducing the crop yield. (Khaliq and Matloob, 2011) Many times it has been observed that hired laborers are not committed to fair and good transplanting of seedlings, this way the average number of plants population (<250,000 plants ha⁻¹) per unit area is reduced (Baloch et al., 2000). Nursery raising for transplanted rice cultivation is not only a risky matter but it also involves energy, is time-consuming, and is also expensive. The risky in sense, that many times after raising nursery, the main field doesn't get prepared due to delayed monsoon rain thus seedlings get overage. Decreasing rice yield due to reduced tillering (Ghosh and Singh, 1994).

Transplanted rice is a mammoth water user (Barker et al., 1998; Kumar and Ladha, 2011), as it utilizes almost three times more water consumption than usually that of other upland crops and also it usually requires a huge quantity of water when the reservoirs and ponds are still filled low in the water. Unless and until these reservoirs are filled with sufficient water for puddling, the farmers are not able to prepare the field which subsequently delays rice transplanting. Therefore, it is imperative to switch over from traditional transplanting for economic gain.

WHY Direct Seeded Rice (DSR):

The direct seeding of rice seems to be the only viable alternative to liberate farmers (Farooq et al., 2011; Kumar and Ladha, 2011; Nie et al., 2012). Dawe, (2005) emphasized that 5 persons –day per ha are required under DSR while it counts about 25-30 person-day per ha under conventional method of transplanting.

However, weeds are the main biological constraint in DSR. A worldwide survey in several rice producing countries revealed that weed infestation was the serious biological constraint limiting the productivity of rice fields (Johnson, 1996). According to Tomita et al., 2003a,b; Rao et al., 2007, the diverse weed flora are found under DSR which has been identified in severe reduction in rice yield under DSR. While the rice seedlings under transplant condition suppress early emerging weeds due to anaerobic condition developed by water logged condition which is absent under DSR. Hence weed control in DSR is a cumbersome practice as they compete with rice seedlings right from beginning as emerging simultaneously with rice seedlings.

Weed Dynamics in DSR: As mentioned earlier, weeds are dynamic in nature, and the composition of weed communities in rice fields is influenced by cultural, mechanical, chemical, and environmental factors. As the weeds in DSR, emerge simultaneously with germination of rice seedlings, invite tough competition, starting from very early in the life of the crop and hence require early weed control. Thus it can be inferred that there is enough room left for developing strategies for effective weed management to harness good rice yield.

. How to develop strategies for weed management in DSR:

1. Prevention:

- Prevention of weed introduction and spread is the most important strategy in managing weeds regardless of crop, establishment method, and ecosystem.

2. Land Preparation:

- It has been reported that in DSR, density, and persistence of weeds in soil are influenced by the method of cultivation, its depth, and frequency of tillage ((Mohler, 1993, Mohler and Galford, 1997). The composition of weed communities is more pronounced on the topsoil surface layer (0-15 cm) as under no-till condition seasonal weeds seeds lie

undisturbed on soil surface than under conventional tillage (Barberi and Lo Cascio, 2001).

- Stale bed methods in which weeds are allowed to emerge before preparation of final seedbed, and are destroyed chemically or mechanically, the suppression of weeds was found to be the extent of 56% (Singh et al., 2009). Effective weed suppression under DSR was also demonstrated by Renu et al., (2000) by combining stale bed method and application of nonselective herbicides than mechanical weeding.

3. Effect of sowing time on weed dynamics:

- It has also been reported that more yield losses occur when weeds emerge earlier or at the same time when crop seeds germinate (Aldrich, 1987). While the reduction in weed pressure was observed more by late planting than early in crops (Buhler and Gunsolus, 1996) for crops such as barley and oat (Légère, 1997), faba bean (Grenz et al., 2005), corn (Williams, 2006), soybean (Buhler and Gunsolus, 1996), and wheat (Zafar, 2012).

4. Impact of planting density on weed dynamics:

- Report of the dominance of *Cyperus rotundus* under dry season tillage and dominance of grasses such as *Digitaria sanguinalis* and *Echinochloa colona* after tillage at the start of the rainy season was suggested by (Castin and Moody, 1980). Tillage in the dry season resulted in increased dominance of *Cyperus rotundus*, whereas grasses such as *Digitaria* spp. and *E. indica* dominated after tillage at the beginning of the rainy season
- Delayed planting reduced the yield loss associated with weeds in soybean (Buhler and Gunsolus, 1996) and corn (Gower et al., 2002) due to increased weed seedling mortality.

5. Impact of row Spacing: The appropriate manipulation of in-row spacing and its orientation will reduce light interception by weeds. For direct-seeded rice, a narrow spacing is desirable for having a competitive edge by a crop over weeds. Chauhan and Johnson, 2010 observed reduced weed biomass and density of *E. colona* and *E. crusgalli* when rice was sown at narrow spacing than a wider one.

6. Mechanical Weed Control: Usually mechanical weeding in DSR is not desirable owing continuous rain makes the soil not fit for mechanical weeding by wheel hoe, grubber, and hand hoe due to wet soil condition and also it hampers the satisfactory result of herbicide application due to soil disturbance by exposing weeds to conducive germinating environment seeds located under deeper layer of soil surface.

7. Nutrient Management: There is a direct relationship of weed dynamics with the nutrient status of the soil. Weeds being nutritive, utilize nutrients more compared to crop plants, thus posing a competitive edge over crop plants in absence of good weed control measures (Mahajan and Timsina, 2011).

8. Water Management: Already discussed that in transplanted rice weed density and biomass is reduced owing to continuous submergence with water compared to DSR. However, flooding in DSR is done immediately after the emergence of rice seeds as rice seeds do not germinate under flooded conditions.

9. Chemical Weed Control: The hand pulling of weeds like *E. colona*, and *E. crusgalli* is very difficult to be uprooted by hand due to smaller in size as well as they mimic with rice seedlings to be separated for identification. The use of chemical herbicides in DSR is going on increasing due to escalating labour wages accompanied with non availability of labour for hand as well as for mechanical weeding.

Under DSR a gap of nearly 4 to 6 weeks to make field permanently flooded, give rise ample opportunity to weeds to emerge and infest the field. Thus to have a good rice yield, pre and post application of appropriate herbicides should be applied. For control of grassy and broad-leaved weeds pendimethalin, benthocarb, and quinclorac can be having residual

activity in soil can be applied at 0-3 DAS before rice and weed emergence and also field has sufficient moisture in field.

10. Integrated weed management: For satisfactory and effective weed control in DSR, single method of weed control is not sufficient unless and until it is combined with other methods. As suggested along with application of herbicides some preventive measures and cultural methods as mentioned above should be integrated for long term suppression of weeds.

Conclusion: Based on above facts it can be concluded that DSR is becoming popular among farmers, however the weed management is a big issue which rests primarily upon herbicide application but associated problems of prolonged use of single herbicide on same land will call other problem of development of herbicide resistance in weeds. Hence, integrated approach is best option to follow in addition to adopt all preventive and appropriate cultural methods like maintain time of sowing, seed rate, stale bed methods, crop residue management, minimum or zero tillage in order to put weed population at minimum level.

RESILIENT PRACTICES FOR USE OF RENEWAL ENERGY TO NATURAL RESOURCE MANAGING AS BIOGAS PLANT TO SELF-RELIANT INDIA

**R.K. PRAJAPATI, B.S. KIRAR, U.S. DHAKAD, I.D. SINGH AND JAIPAL CHHIGARHA
J.N.K.V.V., Krishi Vigyan Kendra, Tikamgarh (M.P.) 472001**

Globalization and global warming argue it creates global competition, resulting in a boost in economic activities that deplete the environment and its natural resources. The increased economic activity leads to greater emissions of industrial pollutants and more environmental degradation. As we can look the world now facing Covid-19 pandemic and population is threatening to setting on edge of death. As per the FAO estimation the global population will be nearly 10 billion people, 34 percent higher than today. This population increase will occur in developing countries on Earth by 2050 about 3 billion more mouths to feed. As incomes rise, people will increasingly consume more resource-intensive, animal-based foods. At the same time, we urgently need to cut greenhouse gas (GHG) emissions from agricultural production and stop conversion of remaining forests to agricultural land. India is ranked first in animal population with 987.5 million of livestock which is 30.7% of the world live stock. The china was initiated biogas programme in 1920 and production now biogas 30 megawatt 44 billion cubic meter biogas while even having a large number of live stocks in India produced biogas only 500 million tones. Andhra Pradesh first in rank with set up 5.5. lacs biogas plants while in Madhya Pradesh 3.7 lacs biogas plants were set up 2019-20. National Innovations on Climate Resilient Agriculture (NICRA) was a network project of the Indian Council of Agricultural Research (ICAR) New Delhi, Govt. of India which was launched in February, 2011. The project aims to enhance resilience of Indian agriculture to climate change and climate vulnerability through strategic research and technology demonstration. The KVK Tikamgarh (M.P.) was implemented the NICRA project in 2011-12 through adaptive NICRA village as Kanti of district- Tikamgarh which situated under Bundelkhand Agro-climatic zone of Madhya Pradesh In Kanti-village there was using FYM as for cooking purpose. In this connection biogas plant were established since 2011 to 2021 in adopted village as per the availability of FYM due to large number of live stock population. The total 188-biogas plants were established in Kanti with convergence and the subsidy of Rs. 13500/- from the Central Government, State Government department and IFFCO unit. The motivation and technological back-stopping were carried out through KVK scientists. Alternate sources of energy- Bio-gas, Hydro-carbons and can produce heat and energy when burnt. Chemically the gas is termed as methane gas. Bio-gas is produced through a bio-chemical process. Bacteria convert the

biological wastes into useful methane through chemical interaction. Such methane gas is renewable through continuous feeding of biological wastes and which are available the main constituent. Biogas slurry contains-N (0.5-1.6), P (0.23-1.4), K (0.8-1.2) while (FYM NPK,0.5:0.2:0.5), Compost (NPK,1.5,1.0,1.5). 1 kg of dry (95%) cattle dung will produced 2.5 kWh (energy). Slurry contains 10% dry matter; thus 1 litre can generate 0.263 kWh. 62% efficiency and the other 38% energy remains in the slurry. Microorganisms need N (nitrogen) and C (carbon) for their metabolism. Now 165-biogas plants are smoothly working after 10-years. The 165-farmer families each families size about 5-person who were cooking their food and saving Rs 887/ per month which was cost of one LPG gas cylinder and total money saving in village about Rs. 146355 while in district this biogas plant was promoted in these since 2011 to 2021 and established about 800 biogas plant through convergence with allied department and NGOs were generated revenue up to Rs. 709600/month, from the health point of view reduced in diseases were recorded in farm women as in cough 27.78%, headache 23.08%, respiratory 18.18% and eye infection 28.57%. Each family earlier were used 5-kg dry wood/day for cooking which were collected from near forest, therefore the total 825 kg dry wood save each day which valued of Rs. 16500/day @ Rs.20/kg dry wood. By burning of one kg dry wood 200 gm Co₂ and 70 g methane produced which are harmful for degrading ozone layer. Through establishment of biogas plant the total 165000 gm Co₂ and 57750 gm methane/day were checked to originate in village. Secondly conservation of green forest also increased because reduction in use of wood for cooking. Bio-gas slurry obtained 25 kg/biogas plant/day and total 4125 kg from 165-biogas plant were increased nutrient and carbon ration in village soil and increase vegetables production saving Rs. 4000/crop/season as reduction of use of chemical fertilizer and boosting the production of vegetable 20% proving extra return Rs. 6000/crop/season/biogas plant. Before installation of biogas plants all households used animal dung for domestic purpose as cakes whereas 36.67% of the household sold animal's dung as waste/fuel/manure, only 16.67% of villagers have adequate knowledge of biogas technology before installation of biogas plants at their household. The biogas plants have been providing per day 3 cubic meter biogas/plant. The life expectancy saving 8.8-month/house wife from used of biogas which was deteriorated due to smoke of cooking. The coming time in future for our Indian to be self-reliant the biogas plant could be better option as natural resource managing by using of renewal energy source

Keywords: Resilient practice, Biogas, Renewal energy, Natural Resource Management

EXPLORING SOCIAL ENGINEERING FOR INNOVATIVE PEST MANAGEMENT

BADAL BHATTACHARYYA

Assam Agricultural University, Jorhat-785013, Assam, India

Social engineering is a data-based scientific system used to develop a sustainable design so as to achieve the intelligent management of resources and capital with the highest levels of freedom, prosperity and happiness within a population. A participatory approach, tends to focus initially on small numbers of clients participatory and is location specific in nature. Rather than “passive participation,” it is aimed to inspire “self-mobilization”, where communities organize and take initiatives independently to solve their problems/issues. Community mobilization is the process of engaging communities to identify community priorities, resources, needs and solutions in such a way as to promote representative participation, good governance, accountability, peaceful change and achieving the objectives. Being a group approach, this concept profoundly relies on all the members coming together to achieve a common goal, finding technical solutions and building capacities in the extension system and bridge the gaps

in knowledge and technology dissemination. An underlying purpose of participatory approaches is the 'empowerment' of disadvantaged groups (Farrington and Martin, 1988; Tavernier, 2006) where large community mobilization can effectively and intelligently be explored in solving some crucial constraints related to agriculture and allied sciences. Such type of approaches not only improves crop productivity and livelihood but also tremendously improves overall knowledge contents and capacity building of the farming community (Deka et al., 2018). Most of such approaches are ecofriendly, economical and sustainable. One major benefit of working through farmers' group is that farmers support each other to learn and adapt (Akinagbe and Ajayi, 2010) and it also reduces the cost of public extension services (Conroy, 2003). The visibilities of extension programmes as well as accountability are also become more vibrant. Under the aegis of All India Network Project on Soil Arthropod Pests, a group based research and extension programme was embraced to tackle a highly endemic and severe key pest species of white grub (*Lepidiota mansueta*) in Majuli river island of Assam, India. The island is a “Bio-diversity hotspot” and has rich ecology with rare breeds of flora and fauna and is a part of a major path for many species of migratory birds. Of late, this island is trying to get the tag “World Heritage Site” from UNESCO because of its unique historic importance, rich biodiversity and co-existence of various cultures.

The white grub, *L. mansueta* was first detected in October 2005 in the farmers' field of Majuli. Field surveys conducted during 2005-2009 revealed that *L. mansueta* had appeared as an extremely severe key pest and the most severely affected crops were potato, sugarcane, Colocasia and green gram and the extent of damage varied from 42-48, 15-20, 35-40 and 30-35%, respectively (Bhattacharyya et al., 2013). Realizing the seriousness of the problem, the seasonal life cycle and biology of *L. mansueta* were studied in crop fields of Majuli and in the laboratory of AINP on Soil Arthropod Pests, AAU, Jorhat during 2005-2009. *L. mansueta* has a biennial life cycle, which is the first of its kind from North East India. It is a unique biennial species, spending its entire life cycle under the ground except for a very short period during which adults come out of the ground for mating. Grubs are voracious feeders. However, there is no evidence showing that the adults fed on any plants either in the field or laboratory and hence this species has the unique distinction as the first Indian phytophagous white grub species with nonfeeding adults (Bhattacharyya et al., 2015). The probable reasons of endemism/outbreak due to the high organic carbon content of the soil (0.75-1.00%) and presence of abundant thatch zone (dead grass, stems and other organic debris) in the endemic pockets. Other reasons may be nonarrival for last several years of the migratory bird Siberian crane (*Grus leucogeranus*), a seasonal predator of the grubs in Majuli probably because of the changing climate with erratic rainfall and early onset of summer in the riverine island. Moreover, conversion of virgin low grass lands (sand bars) by the flood and erosion affected people without taking any grub management measures is also responsible for the outbreak of the species in massive proportions.

After unravelling the seasonal cycle and biology, few vital tipoffs worthy of managing the beetles were learned as mentioned below:

- Rush of adult emergence took place for a short period of time in the evening during April-May, except for this short aerial life for nuptial activity, the species lives a subterranean life.
- Both sexes of the beetles were positively phototactic.
- Beetles emerged from the soil for mating during evening hours and spend almost one hour (6.15-7.15pm) for pre-mating flight. Beetles could be collected in huge numbers by operating light traps in endemic pockets during 6.30-7.00pm.
- Scouting for hand collection is also effective since the mated pairs are found abundantly on selected sheltering plants in field during 7.00-8.30 pm.
- Beetles can also be used as animal feed for poultry, pigs, dogs, cats etc.

- Some indigenous tribes also consume the beetles as their food.
- Concept of Social Engineering/Farmers’ participatory approach could be encouraged for the mass collection and destruction of beetles during the period after premonsoon showers in the endemic areas.

A parallel planning was done to carry out both basic research as well as community action programmes/social engineering/farmers participatory approaches aimed at collecting adult beetles during evening hours (6.00-9.00pm during April-May) as a practical and cost-effective method of management. These extension activities were initiated from 2010 onwards in collaboration with different stakeholders under the theme “Mass campaigning against *L. mansueta* in Majuli river island through social engineering”. Group based approach for the mass collection and destruction of beetles was given the top most priority. Each village was selected based on the population and extent of damages caused by the grubs, presence of functional farm management committee/self-help groups/gram panchayats and a “Lepidiota Management Group” was formed in each endemic village (total 40 villages) consisting of 10 active farmers. Besides involving farmers, collaboration in this regard was sought from farm management committee, self-help groups, KVK, state extension staff, gram panchayat, NGOs and district administration, Majuli. To sensitize farmers the various tools of social engineering viz., smart SMSing to farmers through www.way2sms.com, video-conferencing, use of social networking site, use of print and electronic media, extension trainings, farmer-scientist interaction, field day, exhibition, awareness meeting, documentary shows, posters and banners, distribution of photographs/leaflets, exposure visit, documentary show, use of public address system, conducting field experiments in endemic areas, telephonic discussion, demonstration on collection of beetles using Solar LED light traps, demonstration on using *Lepidiota* beetles as human food/animal feed were used. This mass campaigning programme received overwhelming response and was exceedingly successful leading to massive collection and killing of about 12.35 Lakhs *L. mansueta* beetles in Majuli during 2010-2021. The project team also demonstrated the power of “Social Engineering” by entering into “India Book of Records” by setting a national record of “most beetles collected in three hours” by collecting 73,700 white grub beetles at Majuli river island in 2018. The major advantages of such approach are- (i) the gravid females are killed before egg laying (ii) capacity building amongst the farmers in white grub endemic areas and the management approach is ecofriendly and cost effective. It is worth mentioning that some of the local tribal people relished the cooked/fried adults of *L. mansueta* as protein rich food which opens up an avenue of further research on its nutritive/nutraceutical value (Bhattacharyya et al., 2018). The other impacts of the approach are mentioned below:

- a) There were less emergence of beetles from soil and low population of grubs in both cultivated and non-cultivated fields in areas where the mass collection and destruction of adults by light traps and scouting were undertaken in the previous years.
- b) The crop productivity had also increased in different crops after formation of groups and group based activities.
- c) Farmers re-adopted the crops that were discontinued due to white grub infestation.
- d) Farmers who had the capacity to increase their area under cultivation had started to expand the crops due to reduction of white grub infestation.
- e) Farm income was increased after involving in group activity.
- f) The readoption of Colocasia cultivation by the farmers has restored the nutritional security of farmers.
- g) Some tribes relished the cooked/fried adults of *L. mansueta* as protein rich food which opens up an avenue of further research on its nutritive/nutraceutical value. Since, the traditional method of preparation of the beetles was somewhat crude, attempts were made to float up a concept of “Beetle Fry” and “Roasted Beetles” dish. Beetles were also used

in bulk quantities as feed for pig, dog and poultry. Besides, the farmers were also encouraged to explore the grubs of *L. mansueta* as bait for fishing purpose.

- h) Even, the famers who were not included in groups showed their eagerness to form groups for the task due to spreading effect of group approach in a passive way.
- i) The mass collection and destruction of beetles were carried out during the evening hours (6-9 pm) during the months of heavy emergence of beetles i.e. April-May. Therefore, the farmers virtually did not lose any effective working hours/man-days.
- j) Majuli river island is organic by default. Therefore, the farmers have shown preference as well as adopted the technology because without applying insecticides this dreaded pest could be managed. Farmers were convinced and specially delighted when they could kill the gravid females before egg laying in their field.
- k) Others stakeholders associated with this mass campaigning have also endorsed this technology because a non-chemical approach of management strategy which was primarily based on the concept of the beetle population regulation was successfully implemented.

References

- Akinngbe O M, Ajayi A R. 2010. Challenges of farmer-led extension approaches in Nigeria. *World Journal of Agricultural Agricultural Sciences* 6(4): 353-359.
- Bhattacharyya B, Choudhury B, Das P, Dutta S K, Bhagawati S, Pathak K. 2018. Nutritional composition of certain soil dwelling scarabs of Assam, India. *The Coleopterist Bulletin* 72(2): 339-346.
- Bhattacharyya B, Pujari D, Handique G, Dutta S K. 2013. Monograph on *Lepidiota mansueta* Burmeister (Coleoptera: Scarabaeidae). Directorate of Research (Agri.), Assam Agricultural University, Jorhat.
- Bhattacharyya B, Pujari D, Bhuyan U, Handique G, Baruah A A L H, Dutta S K, Tanaka S. 2015. Seasonal life cycle and biology of *Lepidiota mansueta* (Coleoptera: Scarabaeidae): a serious root-feeding pest in India. *Applied Entomology and Zoology* 50(4): 435-442.
- Conroy C. 2003. New directions for Nigeria’s basic agricultural services. A discussion paper for Basic Agricultural Service (BAS). Natural Resources Institute, University of Greenwich, United Kingdom 1: 61.
- Farrington J, Martin A. 1988. Farmer participation in agricultural research: A review of concepts and practices. Overseas Development Institute, Regent's College, Inner Circle, Regent's Park, London NW1 4NS.
- Deka N, Barman U, Bhattacharyya B. 2018. Farmers’ Attitudes towards Group Approach on Management of White Grub (*Lepidiota mansueta*). *International Journal of Current Microbiology and Applied Sciences* 7(03): 465-471.
- Tavernier E M. 2006. Agricultural policy as a social engineering tool: A New Jersey case study. *Review of Urban & Regional Development Studies* 8(3): 252-263.

IMPACT ON CLIMATIC STRESS MANAGEMENT OF RESILIENT PRACTICES FOR IN-SITU MOISTURE CONSERVATION UNDER BUNDELKHAND AGRO-CLIMATIC ZONE

**B.S. KIRAR, R.K. PRAJAPATI, JAIPAL CHHIGARHA AND I.D. SINGH
J.N.K.V.V., Krishi Vigyan Kendra, Tikamgarh (M.P.) 472001**

The climate change has become an important area of concern for India to ensure food and nutritional security for growing population. The impacts of climate change are global, but country like India is more vulnerable in view of the high population depending on agriculture. In India, significant negative impacts have been implied with medium-term (2010-2039) climate change, predicted to reduce yields by 4.5 to 9%, depending on the magnitude and distribution of warming. Since agriculture makes up roughly 16% of India's GDP, a 4.5 to 9% negative impact on production implies a cost of climate change to be roughly up to 1.5% of GDP/year. National Innovations on Climate Resilient Agriculture (NICRA) was a network project of the Indian Council of Agricultural Research (ICAR) New Delhi, Govt. of India which was launched in February, 2011. The project aims to enhance resilience of Indian agriculture to climate change and vulnerability through strategic research and technology demonstration. The KVK Tikamgarh (M.P.) implemented the NICRA project in 2011-12 through adaptive NICRA village as Kanti of district- Tikamgarh which situated under Bundelkhand Agro-climatic zone of Madhya Pradesh. The climate vulnerability of this zone is extremely rainfall events, prolonged dry spells, early with drawl monsoon or late commencement of monsoon, uneven rain fall distribution and water logging at different crop growth stages. The impact of climate change is evidently visible in Bundelkhand region of Madhya Pradesh. Climate change has hit the agriculture based livelihoods and food grain production in the Bundelkhand districts has decreased by 58%, it is very serious for the agriculture based society and economy. The farmers were sown soybean with local country plough or flatbed method (Broad casting) which was time and labour intensive, during extreme rainfall events, the crop gets affected either due to dry spells or water logging due to lack of proper drainage. There was a need for resilient practice *i.e. in-situ* soil moisture, water conservation and proper drainage. The resilient technology BBF (Board Bed Furrow) sowing method were conducted as farmer field demonstrations in light to medium and deep black soils among the 200-farmers of village during the rainy (*Kharif*) seasons since 2011 to 2020, to evaluate the effect of mechanization practices coupled with different *in-situ* rain water-conservation resilient practices on soybean (*Glycine max* (L.)). BBF system involves preparation of a broad bed of 90 cm, furrow of 45 cm and sowing of crop at a row spacing of 30 cm above on bed. The treatments comprising complete mechanization, partial mechanization and traditional methods of cultivation (flat bed) were evaluated for variety JS - 9560 (short duration drought tolerant) soybean along with sub-plot treatments of broad bed and furrow (BBF), ridges and furrow and flat bed. The BBF technology has many advantages including *in-situ* conservation of rain water in furrows, better drainage of excess water and proper aeration in the seed bed and root zone. More than 200-farmers in village adopted the technology. Similarly, BBF planting was promoted for cultivation of different crops in Tikamgarh district through convergence with allied department the horizontal spread of technology in 426- villages with 29820- hectares among 74550 farmers were recorded in soybean variety JS 9560. Complete mechanization in soybean resulted in higher seed yield 15.3 q/ha in demonstration as compared to farmer practice 11.8 q/ha, maximum gross monetary returns, net monetary returns, benefit cost ratio, water use efficiency, crop productivity were recorded increased as compared to control plots , BBF helped only on early stage moisture stress or dry spell, reduced lifesaving irrigation water up to (65-70%.) Crop was tolerant to dry

spell up to 10-15 days during mid-season, required lower seed rate, better, reduced the incidence of weed (15%) , disease (28%) and insect-pest (30%), crop lodging as compared to traditional method of cultivation were found lowest. BBF method of sowing in soybean proved be significantly superior to all treatment combinations. The highest energy output-input ratio was observed in with BBF method of sowing. BBF used for sowing but after two rains reduced raised bed up to 75-90% depending on rain intensive in light and medium soil. Even on heavy rain fall about 222 mm during maturity and harvesting stage yield saving also recorded on BFF method sown crops as soybean (70%), black gram (30%) and sesame (25%). The seed viability of these saved yield of heavy rain affected crops were recorded up to 55% while totally loosed seed viability found in farmers practiced

Keywords: Resilient practice, Climate change, Broad bed and furrow, dry spell, Infiltration

ROLE OF PKV MINI DAL MILL IN RURAL ENTREPRENEURSHIP DEVELOPMENT

N.V. SHENDE, R. D. VAIDKAR, V. K. KHOBARKAR AND D. K. NEMADE

Department of Agricultural Economics and Statistic, PGI, Dr PDKV, Akola, Maharashtra, India

ABSTRACT

Post-harvest processing is one of the necessary steps in conversion, value addition and prevention of loss of agricultural produce. It is essential operation being carried out prior to consumption of agro produce. Most of the post-harvest processing operations are performed at urban side resulting into increased cost of transportation and storage requirement besides loss of some important byproducts and post-harvest losses. Primary or secondary processing of agricultural produce at village level will help to reduce the cost of processed material, giving additional income source to producer, employment generation among the rural youths and in situ value addition. As a result, processed product will be available at lower cost for the rural population also. In view of this the study on economic evaluation and impact assessment of PKV mini da mill was conducted at three district of Vidarbha region viz; Amravati, Akola and Buldhana. The primary as well as secondary data were collected for economic analysis. The cost and returns were estimated on the basis of primary data collected from 30 farmers. The breakeven point and economic impact were estimated. The study revealed that income of the farmers was increased and migration ceased. It can be installed at a low capital investment of about Rs146461/- only. The variable expenses for running PKV mini dal mill was worked out about Rs 25736.80/- per annum. On an average the quantity of raw material processed accounted to 417 quintals within 150 days, as per raw material available. The processing cost per quintal of PKV mini dal mill were Rs. 450/-.The cost benefit ratio from PKV mini dal mill worked out to 2.81. It revealed that farmer received more than doubled income form PKV mini dal mill after one year of establishment. The breakeven point is 497.81 qtl. As the dal processed in the PKV Mini Dal mill is good in quality, hence 26 per cent farmers state that family member utilized as labour. The inadequate supply of electricity was the major problem faced by the farmers. However, 36 per cent dal mill owner facing the problem of technical knowledge about operating of machinery.It helps to engage the farmers to start subsidiaery enterprise to doubling their income.

EFFECT OF ORGANIC MANURES AND BIOFERTILIZERS ON GROWTH AND YIELD OF WATERMELON (*Citrullus lanatus* Thunb.)

ARVIND M. SONKAMBLE*, ADITYA MAPARI, SURENDRA R. PATIL AND VISHAL D. TAYADE

**Department of Vegetable Science, Dr. Panjabrao Deshmukh Krishi Vidyapeeth, Akola (M.S.)
India**

ABSTRACT

A field experiment entitled "Effect of organic manures and biofertilizers on growth and yield of watermelon (*Citrullus lanatus* Thunb.)" was conducted at Instructional Farm, Department of Vegetable Science, Dr. Panjabrao Deshmukh Krishi Vidyapeeth, Akola during summer season of 2019 - 2020. The experiment was laid out in Randomized Block Design (RBD) with three replications and nine treatments viz. T1 (Farm Yard Manure @ 40 t ha⁻¹), T2 (Compost (NADEP) @ 18 t ha⁻¹), T3 (Vermicompost @ 13.5 t ha⁻¹), T4 (Poultry manure @ 6.6 t ha⁻¹) and T5 (Farm Yard Manure @ 40 t ha⁻¹ + Soil application of *Azotobacter*+ PSB @ 5 kg ha⁻¹ each), T6 (Compost (NADEP) @ 18 t ha⁻¹ + Soil application of *Azotobacter*+ PSB @ 5 kg ha⁻¹ each), T7 (Vermicompost @ 13.5 t ha⁻¹ + Soil application of *Azotobacter*+ PSB @ 5 kg ha⁻¹ each), T8 (Poultry manure @ 6.6 t ha⁻¹ + Soil application of *Azotobacter*+ PSB @ 5 kg ha⁻¹ each), T9 Control (RDF- 200:100:100 NPK Kg/ha). Observations in respect of vine growth and yield of watermelon were recorded periodically. From the findings, it was observed that the growth parameters in respect length of main vine, number of leaves, number of primary branches, chlorophyll index, days for first female flower appearance, internodal distance and male female ratio were found better with Vermicompost @ 13.5 t ha⁻¹+ soil application of *Azotobacter* +PSB @ 5kg ha⁻¹ each. Yield parameters i.e., days required for edible maturity, number of fruits per vine, average fruit weight, fruit yield per vine and fruit yield per ha⁻¹ were found to be maximum with Vermicompost @ 13.5 t ha⁻¹+ soil application of *Azotobacter* +PSB @ 5kg ha⁻¹ each.

Keywords: Watermelon, organic manures, biofertilizers, growth and yield

DOMESTICATION OF NATIVE WILD FRUITS FOR DIVERSIFICATION IN MAHARASHTRA REGION OF INDIA

SURENDRA R. PATIL¹, ARVIND M. SONKAMBLE² AND ABHAY P. GEDAM³

Department of Fruit Science, Dr. Panjabrao Deshmukh Krishi Vidyapeeth, Akola (MS) India

ABSTRACT

Wild edible plants (WEPs) are the species those are neither cultivated nor domesticated but growing wild and are however edible (Beluhan and Ranogajec, 2010). Different wild edible plants have played a significant role in all geographical regions of world throughout human history (Sekeroglu et al., 2006). Poor communities through the world are dependent on these wild plants for their food, nutrition, subsistence needs and improving rural livelihoods as well (Sundriyal et al., 2003). Even nutritional superiority of some of the wild edibles was also reported over the cultivated ones (Burlingame, 2000). The traditional consumption of WEP is still supplemented today with staple crop plants by most agrarian societies throughout the world (Lulekal et al., 2011). The role of WEPs in ensuring food and nutritional security to the rural or indigenous communities is now widely recognized. Unfortunately data available on their identification, composition or nutritional properties, use and management or user's preferences is scanty or less documented (Frison et al., 2006; Vincetti et al., 2008).

Maharashtra is one of the rich states in terms of floristic and ethnic diversity in India. Vartak and Gadgil (1980) reported 120 wild food plants from Maharashtra and Goa out of which the six wild edible plants from Maharashtra i.e. *Diospyros peregrina*, *Grewia latifolia*, *Optunia elatior*, *Capparis zeylanica*, *Flacourtia indica*, *Elaeagnus conferta* found potential for commercial exploitation. These wild edible plants are rich in nutrients, vitamins and fibers. These plants may become the supplementary source of food for common peoples if brought under cultivation. Such edible plants and wild relatives of the established crop plants are reservoirs of important desirable genes for resistance against fungal, bacterial and especially viral pathogens. They also harbor resistant genes for adverse climatic conditions such as drought, frost, water lodging, etc. Such resources could be used to broaden the gene pool of crop plants.

Domestication of wild relative plants can broaden genetic diversity which will help to fight against the pest, diseases and also the climate change. Wild edible plants can be grown in the areas where traditional crops are failed. Wild edible plants are hardy and can grow in adverse conditions with minimum inputs. Need to aware farmers consumers about the importance and potentiality of wild edible plants. Converting the wild edible plant into crop plant is not always easy as domestication of wild edible fruit plant the time-consuming process.

CITRUS DECLINE IN HILL AND MOUNTAINOUS ECOSYSTEM OF WEST BENGAL

SAJEED ALLI, B. R. SHARMA, T.S. GHIMIRAY, S. GURUNG, H. K. TARAFDER, S. BASKEY, BISWAJIT PATRA, BANDAN THAPA AND ANWESH RAI

Regional Research Station (Hill Zone), Uttar Banga Krishi Viswavidyalaya, Kalimpong, West Bengal.

Hill and mountainous eco-system of West Bengal is situated between 27°13' and 26°31' North and 88°53' and 87°59' East, and receives 2500mm to 3000mm of rainfall annually. These weather conditions are ideal for growing citrus species, particularly Mandarin oranges (*Citrus reticulata* Blanco.). It has been grown in this region for many years and is one of the most significant fruit crops with a strong demand in both domestic and foreign trade. However, the production of Mandarin is currently suffering on both a quantitative and qualitative level, this bottleneck in citrus industry is known as citrus decline. There are many factors associated with this malady, in this summery, an attempt has been made to describe these factors.

Diseases and insect-pest

Among the fungal diseases, Foot rot and gummosis caused by *Phytophthora* species is most destructive, the disease is characterised by rotting of the bark at the stem and collar, followed by yellowing and blighting. Later, the gum clusters in the bark break apart and expose the wood to secondary infection. Then trunk shows girdling character but prior to death, the infected tree blossoms heavily and die before fruits mature. Other fungal disease like, Powdery mildew, felt, *Ganoderma* Root Rot, *Diplodia* gummosis, twig blight also plays important role in Citrus Decline.

Similarly, the Greening is one of the most devastating bacterial diseases affecting mandarin. Ahlawat observed localised Citrus greening disease infection in Darjeeling in 1997, and Das claimed that it infected 10–20 percent of Darjeeling mandarin in 2008. The disease is caused by fastidious, phloem-limited bacterium *Candidatus Liberibacter asiaticus* transmitted by Asian citrus psyllid, *Diaphorina citri*. The main characteristic symptoms are leaf chlorosis, premature defoliation, emergence profuse small leaves, die-back of twigs, the fruits are irregularly shaped, pale, thick jacketed and aborted.

Besides, fungus and bacteria, Mandarin is also host of several viruses which directly contributes to its decline. Among the virus diseases, Citrus Tristeza Virus (CTV) is most widespread in Darjeeling hills (Biswas, 2008; Biswas, *et al.* 2014; Ghosh 2014 *et al.* 2014; Palchoudary *et al.*, 2017). The development of deficiency-like symptoms in leaves, dieback of twigs and stem pitting, reduced yield are the main symptoms of CTV. It is transmitted by Citrus aphid *Toxoptera citricidus*.

Among the Insect-pest, Trunk borer (*Anoplophora versteegi*) and Fruit flies (*Bactrocera minax* and *B. dorsalis*) are most destructive. Hundred percent infestations of Trunk borer have been observed in some orchards. The feeding by larvae of Trunk borer disrupts the translocation of water and food materials resulting dying of trees. On the other hand, maggots of fruit flies feeds on the fruit pulp, the affected fruits rot and fall down along with maggots.

Besides trunk borer and fruit flies, other insect-pests like leaf miner (*Phyllocnistis citrella*), aphids (*Toxoptera* sp., *Aphis pomi* and *Myzus persicae*), scale pests (*Mytilococcus* sp.) red mites (*Panonychus citri*), mealy bug (*Planococcus citri*), lemon butterfly (*Papilio demoleus*), top shoot borer, bark eating caterpillar, blackfly (*Aleurocanthus woglumi*), Fruit sucking moth (*Othoris* spp.) and nematode (*Tylenchulus Semipenetrans*) also contributes to the Citrus decline.

Poly-embryony

In mandarin, there are production of two types of seedlings *i.e* Nucellar and Zygotic. Zygotic seedling bears the characters of both parents. But the nucellar seedlings produce true to the type progeny. Planting of nucellar seedling is essential for uniformity and yield consistency. Initially the zygotic seedlings are good in vigour and health compared to nucellar, thus the growers opt for the zygotic seedlings instead of nucellar, resulting high degree of genetic diversity among the population

Inter-cropping or Mixed-cropping

Mandarin growers of Darjeeling and Kalimpong hills intercrop mandarin with crops like ginger, maize, potato, cucurbits etc. for additional revenue. This exercise of intercropping mandarin with nutrient exhaustive crops and creeping type vegetables aggravates the problem further.

Poor nutrient status of soil:

It is a well-known fact that the soils Darjeeling and Kalimpong hills are sandy loam in texture with acidic reaction with very low in micro and macro-nutrient contents. This poor nutrient status of soil coupled with very low rate of nutrient application by the farmer makes the soil unsuitable for good harvest of mandarin.

Socio-economic factors

The technology driven youth of this generation do not prefer farming but jobs in government or corporate sectors resulting rural migration. In Darjeeling and Kalimpong hills, a significant number of people migrated to big cities for better employment opportunities and livelihood. This migration has caused a serious threat to agriculture in general.

Conclusion:

There are several of factors associated with citrus. Among them, Diseases, insect-pest, highly acidic soil, low organic matter content in soil, faulty practices and socio-economic factors are vital. However, the technologies to combat this malady have been generated by research institute and extension agencies to foster the lost glory of Darjeeling Mandarin.

References

- Ahlawat, Y.S. (1997) Viruses, greening, bacterium and viroids associated with citrus (*Citrus* sp.) decline in India. *Indian J. Agril. Sci.* 67:51-57.
- Biswas Kajal K. Godara Shruti, Nayak Dipak (2014) Distribution of Citrus tristeza virus in the Darjeeling hills and their biological symptoms in mandarin orchards. *Indian Journal of Horticulture* Volume: 71 (3) 408-411

Biswas, K. K. (2008) Molecular diagnosis of *Citrus tristeza virus* in mandarin (*Citrus reticulata*) orchards of Darjeeling hills of West Bengal. Indian Journal of Virology Vol. 19 No. 1 pp. 26-31

Das, A. K. (2008) Citrus Greening (Huanglongbing) disease in India: Present status and diagnostic efforts. IRCHLB Proceedings, Dec, 2008

Ghosh, Amalendu Das Amrita, Meena Ramu V. K. Baranwal (2014) Evidence for resistance to *Citrus tristeza virus* in pomelo (*Citrus maxima* Merr.) grown in Darjeeling and Sikkim hills of India, Phytoparasitica 42(4) 503–508

Palchoudhury, S, Ghimiray, S. P., Biswas, M. K and Biswas, K. K.(2017) Citrus tristeza Virus Variants and their Distribution in Mandarin Orchards in Northeastern Himalayan Hill Region of India, Int.J.Curr.Microbiol.App.Sci 6 (6): 1680-1690.

WEED CROPS TO FOOD CROPS; A TIMELY NEED APPROACH TO ACHIEVE FUTURE FOOD SECURITY AND SUSTAINABILITY

MD. AMIRUL ALAM, NADIRAH T. A. AND SALLEH, M.

Faculty of Sustainable Agriculture (FPL), Universiti Malaysia Sabah (UMS), Sandakan Campus, Sandakan, Sabah

Purpose

Weeds are the costliest category of agricultural pests. Worldwide, weeds cause more yield loss and add more to farmers’ production costs than insect pests, crop pathogens, root-feeding nematodes, or warm-blooded pests (Schonbeck, 2013). The plants we call weeds do a vital job in ecosystems: they quickly establish in, protect, and restore soil that has been left exposed by natural and human-caused disturbances (Schonbeck, 2013). On the contrary weeds are also more tolerant to biotic and abiotic stresses over cultivated crop species. So, consumption of edible weeds community will be the best economic weed management practices adding new members with the crop lists with additional advantages of using uncultivable/fallow lands. In this universe one plant in every ten plants is a weed meaning is that there are approximately 30000 weed species globally, among which 89% are edible and many of these weed species have a high nutritional value with medicinal properties (Duke, 1992; Rapoport et al., 1995). Yet, humankind has, over time, used more than 7,000 edible species. Of particular concern, wild and feral crop relatives are the original source of raw genetic material from which all modern crop varieties were first developed, but these reservoirs of natural variation have not been well studied. Undoubtedly this will greatly contribute to the global food security.

Methods

In this experiment several weeds were evaluated for the important antioxidant compounds, antioxidant activities and major micro and macro minerals like; *Portulaca oleracea* L., *Peperomia pellucida* L., *Trianthema portulacastrum* L., *Amaranthus viridis* L., *Ipomea aquatica* Forssk. and *Centella asiatica* L. were investigated. The seedlings of *P. oleracea*, *T. portulacastrum*, *P. pellucida*, *A. viridis*, *I. aquatica* and *C. asiatica* were collected from surrounding area and transplanted into plastic pots (39 cm x 22 cm) filled with prepared soil @ the ratio of 3:2:1 mixing top soil, sand and organic matter, respectively with three replicates following Randomized Complete Block Design (RCBD). Shoots and leaves from each plant was collected before flowering for the detailed analysis mentioned above. *Amranthus tricolor* was taken as control to compare with all these weed crops. Sample extraction was done following the methods of Alam et al. (2015) from the oven dried blended plant samples. Total Phenolic Compounds (TPC) determination was done following Folin-Ciocalteu method (Alam et al., 2015); Total flavonoid content (TFC) was quantified using colorimetric analysis (Abu Bakar et al., 2009); Total carotenoid content (TCC) was measured following the methods of

Alam et al. (2015); β -carotene content was measured following AOAC international standard methodology. FRAP (Ferric reducing antioxidant power assay) and free radical scavenging activity antioxidant activity was determined using DPPH (1,1-Diphenyl-2-Picrylhydrazyl) assay following the methods used by Alam et al. (2015). Among the major micro-macro minerals Calcium, Potassium, Phosphorus, Magnesium and Nitrogen was determined using dry ashing method. The extracted sample was examined by applying ICP-OES - Inductively Coupled Plasma Optical Emission Spectrometry. The analysis of every sample was repeated three times.

Results

Total phenolic contents significantly varied ($p < 0.05$) among the three species being the highest in *T. portulacastrum* ($2.67 \pm 0.45 \text{ mg g}^{-1}$) followed by *P. pellucida* ($1.96 \pm 0.08 \text{ mg/g}$) and *P. oleracea* ($1.63 \pm 0.22 \text{ mg/g}$), respectively (Fig. 1). The total phenolic content in *T. portulacastrum* was about 163% higher than *P. oleracea* and about 136% higher than that of *P. pellucida*. On the other hand, *P. pellucida* had 120% higher content of TPC over *P. oleracea*. TFC in *T. portulacastrum* was remarkably and significantly ($p \leq 0.05$) higher ($0.34 \pm 0.05 \text{ mg g}^{-1}$) compared to the other two species (Fig. 1b). TFC in *P. pellucida* and *P. oleracea* were statistically similar (around 0.10 mg g^{-1}). The TFC in *T. portulacastrum* had about more than 340% over the other two species. Among the three species, the highest amount of total carotenoid content ($0.047 \pm 0.003 \text{ mg g}^{-1}$) was recorded in *T. portulacastrum* (Fig. 1c). Statistically similar Carotenoid contents was detected both in *P. oleracea* ($0.024 \pm 0.07 \text{ mg g}^{-1}$) and *P. pellucida* ($0.021 \pm 0.002 \text{ mg g}^{-1}$), but *T. portulacastrum* showed significantly ($p \leq 0.05$) lower TCC compared to other two species. The β -carotene contents significantly ($p < 0.05$) varied between the three species being the highest in *T. portulacastrum* ($1.9 \pm 0.10 \text{ mg g}^{-1}$), followed by *Peperomia pellucida* ($1.48 \pm 0.005 \text{ mg g}^{-1}$). Significant and remarkably lowest content of β -carotene was recorded in *P. oleracea* ($0.11 \pm 0.06 \text{ mg g}^{-1}$). β -carotene in *T. portulacastrum*, species was about 17- and 13-folds higher compared to *P. pellucida* and *P. oleracea* respectively.

The FRAP values significantly ($p < 0.05$) and greatly varied between the three species. *T. portulacastrum* had the highest FRAP value ($20.63 \pm 0.01 \text{ mg/g}$) followed by *Peperomia pellucida* ($6.14 \pm 0.01 \text{ mg/g}$) and *P. oleracea* ($1.61 \pm 0.05 \text{ mg/g}$; Fig. 5). Among the three species, *T. portulacastrum* had 3- and 20-fold higher FRAP activity compared to *P. pellucida* and *P. oleracea* species, respectively. The maximum DPPH activity was exposed by the extracted sample of *P. pellucida* ($\text{IC}_{50} = 7 \text{ }\mu\text{g/mL}$), followed by *T. portulacastrum* ($\text{IC}_{50} = 28 \text{ }\mu\text{g/mL}$). *P. oleracea* showed the lowest DPPH activity ($\text{IC}_{50} = 46 \text{ }\mu\text{g/mL}$) (Fig. 3). Among the three species the variation for IC_{50} values were highly significant ($p \leq 0.5$) and the lowest the IC_{50} value represents the highest DPPH activity. The ability of tested composites to scavenge the radicals independently from any enzymatic activity is the representative of the bleaching of DPPH absorption. The macro-micro minerals analyses results revealed significant ($p < 0.05$) and remarkable variations in macro-minerals (P, K, Ca, Na and Mg) among the three underutilized medicinal herbs. However, micro-minerals (Fe, Zn and Mn) differences were not significant. Phosphorus contents ranged between 2.28 - 8.89 g/kg being the highest in *P. pellucida* (8.89 g/kg) followed by *P. oleracea* (7.97 g/kg). Around 2-fold K content was recorded in *P. oleracea* (55.47 g/kg) compared to other two species. Calcium content was the highest in *P. pellucida* (0.25 g/kg) followed by *T. portulacastrum* (0.13 g/kg). *P. oleracea* had the lowest content of Ca (0.09 g/kg). Remarkable differences (0.23 – 23.87 g/kg) in Na contents were observed among the three species being the highest in *T. portulacastrum* (23.87 g/kg) and the lowest in *P. oleracea* (0.23 g/kg). *P. pellucida* had significant and remarkably higher amount of Mg (8.89 g/kg) compared to the other two species. *T. portulacastrum* and *P. oleracea* had respectively 2.26 and 1.94 g/kg Mg contents which were significantly ($p < 0.05$) different.

Conclusions

This study demonstrated that all these underutilized weeds had significant amounts of varied antioxidant compounds, antioxidant activities and major macro and micro minerals. Overall *T. portulacastrum* contained the maximum TPC, TFC, TCC and beta-carotene contents in comparison with the other two species owing to the higher contents of phenolic compounds in *T. portulacastrum*. However, regarding antioxidant activity, the highest DPPH activity was detected in *P. pellucida* while the highest FRAP activity was determined in *T. portulacastrum*. A clear positive correlation was noticed between DPPH inhibition percentage (%) and contents of TPC. As the total phenolic content increased, the inhibition percentage (%) of DPPH free radical increased. Regarding mineral constituents, *P. oleracea* contained the highest amount of K, whereas *P. pellucida* had the highest most other macro-micro minerals content compared to the other two species. Taken together, the findings suggested that all these weed crops can be recommended for human consumption as rich sources of natural antioxidants and minerals and can easily be substituted to many commonly cultivated vegetable crops to ensure future food security and sustainability.

Keywords: Phenolic contents, flavonoid contents, β -carotene contents. FRAP assay, DPPH assay, micro-macro minerals.

References

- Abu Bakar, M. F., Mohamed, M., Rahmat, A., Fry, J. (2009). Phytochemicals and antioxidant activity of different parts of bambangan (*Mangifera pajang*) and tarap (*Artocarpus odoratissimus*). *Food Chemistry*, 113(2): 479-483.
- Alam, M. A., Juraimi, A. S., Rafii, M. Y., Hamid, A. A., Aslani, F., Alam, M. Z. (2015). Effects of salinity and salinity-induced augmented bioactive compounds in purslane (*Portulaca oleracea* L.) for possible economical use. *Food Chemistry*, 169: 439-447.
- Duke, J. A. (2000). Handbook of edible weeds. 1st Edition, CRC Press, Boca Raton, Florida, United States. ISBN-13: 978-0849329463, pp 256.
- Rapoport, E. H., Raffaele, E., Ghermandi, L., Margutti, L. (1995). Edible weeds: a scarcely used resource. *Bulletin of the Ecological Society of America*, 76(3): 163-166.
- Schonbeck, M. (2013). An ecological understanding of weeds. Organic Agriculture, online publication on August 20, 2013.

COLLECTION, CONSERVATION AND PROFILING OF MAIZE GENETIC RESOURCES TO REDESIGN MAIZE AS A NUTRICEREAL IN FOOD SECTOR

SURINDER SANDHU, JS CHAWLA, GAGANDEEP SINGH, YOGESH VIKAL AND TOSH GARG

Department of Plant Breeding and Genetics, Punjab Agricultural University, Ludhiana-141 004 (Punjab), India

ABSTRACT

With remarkable research interventions, India not only achieved food security but have overflowing foodgrains in godowns. Now there is clarion call to re-orient our research strategies to nutritional security of masses.

Maize (*Zea mays* L.) is one of the most important crops worldwide serving as food, livestock feed, and component of industrial products. With its high content of carbohydrates, fats, proteins, some of the important vitamins and minerals, maize acquired a well-deserved reputation as a ‘poor man’s’ nutriceal (Prasanna et al., 2001). The maize grain accounts for about 15 to 56% of the total daily calories in diets of people in about 25 developing countries, particularly in Asia, Africa and Latin America where animal protein is scarce and expensive and consequently, unavailable to a vast sector of the population. Traditionally, vitamins and

minerals have been added to food crops through supplementation or fortification practices. However, the application of dietary diversification, supplementation, and fortification have their own pros and cons, and a right mix of all the intervention approaches has to be employed to overcome the problem of hidden hunger (Gómez-Galera *et al.*, 2010). Therefore, biofortification is a more sustainable approach for solving the problem of ‘hidden hunger’ through breeding of crops to accumulate nutritionally important compounds and thereby avoiding the need to fortify processed food products. Globally, nearly 200 million children younger than five years are undernourished for protein, leading to a number of health problems, including stunted growth, weakened resistance to infection and impaired intellectual development. Science and technology have been immensely aiding mankind’s continuing efforts to combat poverty, hunger and malnutrition.

Keywords: Maize, hidden hunger, quality protein maize, waxy maize, baby corn, nutricereal

CLIMATE CHANGE IMPACTS AND HEALTH RISKS

ZOYA AKRAMI*, A. KHAN2*, SHAFIQUE ZEHR3, SANYUKTA MANDAL4, ASHUTOSH KUMAR5, TARANNUM ARA6, DIKSHA BHARATI7, BINIT BHASKAR8
1,2,3,4,5,6,7,8, (Purana University Purana), Department of Chemistry (Purana College Purana)

ABSTRACT

A crucial challenge for humanity in coming decades is to reduce the adverse effects of climate change that are already being observed in our planet’s environment. India is a diverse country in terms of geographical climatic conditions and owing to this diversity each state /UTs may have morbidity and mortality due to health ailments like cardiovascular, respiratory problems, malaria and other infectious or non-infectious diseases which may occur as per climatic changes and conditions such as heat stress, precipitation etc.

Growing human populations are demanding significant increase in economic development that accelerates climate change. Moreover, there is a clear need to substantially reduce many negative effects of industry and agriculture that decrease the adverse effects of climate change. The problem is deepening further with the increasing competition that modern human societies are experiencing for land, water, and energy. Consequences of climate change have several multifaceted effects which might lead to collapse of ecosystems, biological invasion, and loss of biodiversity. To provide new insights on protection, control over the populations of ecosystems and systematic researches on the characteristic of climate change and its impacts on biological dynamics are of great practical significance.

The impacts of climate change on biological dynamics are focused on two aspects. On one hand, more attention should be paid to the characteristics and actual impact of climate change on biological and ecological systems. On the other hand, to adapt to the varied situation caused by climate change, new perspective and methods should be explored and used in study on biodynamic systems. For example, climate change might lead to changes in immune system and immune function of organisms and biological systems, inducing the emergence of new diseases, and some variations of transmission of infectious diseases. Therefore, some previous methods, such as reaction diffusion equations and complex networks, need to be improved.

Keywords - Climate change, human Health, Heat stress

Introduction

‘Global Climate Change’ concept is very complicated people’s are still fully unaware about the risk and consequences of global climate change on human health in coming decades. Mostly researcher’s discussion is about the consequences of climate changes and its risk on economic conditions, assailable industries, envoi mental resources and ecosystems. It is also necessary

for the survival of human beings and societies but the human health is more important than another element of the life. We construct our societies to attain the resources, economic growth and security but these are the means of the survival of human beings and health. In developing and underdeveloped countries health sector is ignored as compare to other sectors. The government should be taken serious implementation steps for health Care system to cure the human health due to the climate change. The WHO estimates that between 2030 -2050, climate change is expected to cause 250000 additional deaths from malnutrition, malaria and heat effects.

Health is the state of physical and psychological condition of persons. The effects of climate on human health are known since early years. The link between the climate and human health is in certain ways. Earth System Science Partnership (ESSP) and Global Environmental Change and Human Health (GECHH) a joint project on climate change observes that, “It widely understood that human societies and the well-being and health of their populations depend on the flow of materials, services and cultural enrichment from the natural world.

The World Health Day (2008) focused on to secure the health from the effects of global climate change. The purpose of this day is to synthesize the people about the adverse effect on health due to the climate change. In past century (1901-2012), the average temperature of the global climate has been increased by 0.6 ± 2.5 °C.

In India, heavy rains start d immunityuring in the summer season rather than winter. Due to climate change, winter season is shrinking and summer season will be extended. These climate change would be regorously impact on the agriculture, health and economic sectors. Hence h & health risks from Environmental Change & Climate change is a complex phenomenon which relate to the environmental conditions and processes that can increase the health risks. There is a direct effect on health due to increase the extreme weather condition and it is not just only weather conditions but also environmental changing, ecology and social climate changes are resulted to effect human health. The most common events that increase the health risks are heat waves, storms, cyclones, fires and flood and are due to the environmental changing different kinds of diseases are spreading which is h harmful for the human health and sometimes it resulted death.

ENVIRONMENTAL HAZARDS

Storms, scarcity and other climate threats are pretend to increase in the severity and density. To control this, health security plans must be prepared. Tropical Cyclones and other storms consequences are abrasion and deaths, damage in crops, livestock and housing. There is a harmful effect on the health due to the environmental disasters like storms and flood. The outermost layer of the earth is the Pedosphere. It is made up of soil and soil processes. Pedosphere is the collection of soil, water, air and all the organisms on the earth. It is consider as the covering of the earth. It protects the earth from the dynamic interactions happening between the atmosphere and other layers like biosphere and lithosphere.

Heat Stress can cause stress especially in those peoples who have high level physical activity and on children and elder peoples as compare to younger peoples because they have a less immunity or resistant power in their body. Direct heat reduces the capacity of the people to work more efficiently. Peoples who work in heat like sheepshearers, cattle mutterers, fire fighter, mine workers and labourers are more suffer through heat. Climate change has been described by the WHO as the biggest threat to health in the 21st century.

VECTOR RELATED TO INFETIOUS DISEASE

Many infectious diseases are caused by the climate condition such as dengue virus. Dengue is a virus which spread due to mosquito. It is common in e sub-tropical region around the world. This disease may cause due to human made environments. It attacks on all ages but in children this disease is milder than adults. Mosquito borne disease are interrelated with climate. Dengue is a very serious infectious disease which causes death and mostly spread in summer season. It

affects body immune system. Body could not produce the enough white platelets which is necessary for human health that causes the death.

FOOD BORN DISEASE

The symptoms of this disease are very mild but can be serious and resulted death. It is a food borne disease which is related to climate change. Salmonella species bacteria is found in food and it is related to the temperature indicating the causes of climate change. Staphylococcus aureus is a bacterium which grows in food and produces a harmful toxin which result severe food poisoning. The spread of these bacterium increases when the temperature of food storage is not sufficient or optimum and such type of food becomes more dangerous for health.

DERMAL PROBLEM

Heat caused skin diseases all around the world whereas direct heat effects on the skin which changes in texture/colour, spots on body and face, allergies, acne-vulgeris, eczema. This disease mostly found in younger peoples who mostly faced sun rays. These disease effects on sunexposed areas of the body like hands, neck, foot and face. Long-term acquaintance of heat becomes the cause of cancer of skin. It becomes the cause of skin changes like hyperkeratosis and pigmentation variations.

Conclusion

Health impacts due to climate change happening all over the earth but the variety of these impacts is found mostly in Pakistan. To control all these climate change effect on human health, there is diversity of methods and strategies have to apply for mitigation and prepare the people for the adaptation of different environmental factors.

Health communities and individuals should be encouraged for achieving the direct co-benefits to cope with environmental changes as a result of mitigation and adaptation.

One of the most common adaptive strategies that many countries are now applying to aware the people about the risk of climate change and health risk associated with them. However, they become able to manage themselves according to that environment. They manage the crop according to the seasons so that they remain save from the harmful effect of climate change. By understanding all these factors, we can plan to minimise exposure and health risks and to cope with the unavoidable effects of climate change keeping in view the human population.

References

1. Global Environmental Change and Human Health (2007) Science Plan and Implementation Strategy. Earth System Science Partnership (DIVERSITAS, IGBP, IHDP, and WCRP) Report No. 4; Global Environmental Change and Human Health Report No.1
2. WHO. (2008). Protecting Health from Climate Change- World Health Day 2008. Geneva. Switzerland.
3. IPCC, 2014: Climate Change 2014: Synthesis Report. Contribution of Working Groups I, II and III to the Fifth Assessment Report of the Intergovernmental Panel on Climate Change [Core Writing Team, R.K. Pachauri and L.A. Meyer (eds.)]. IPCC, Geneva, Switzerland, 151 pp. [Online] Available from: <http://www.ipcc.ch> [Accessed on 22/03/2017]
4. Germanwatch. (2017). Global Climate Risk Index 2017: Who suffers most from Extreme weather events? Weather related loss events in 2015 and 1996 to 2015. [Online] Available at: www.germanwatch.org [Accessed on 23/03/2017]
5. Maplecroft, V. (2011). Climate Change Vulnerability Index 2016. Climate Change and Environmental Risk Atlas. <https://maplecroft.com/portfolio/countries/PK/>
6. Boden, T.A., G. Marland, and R.J. Andres. 2016. Global, Regional, and National FossilFuel CO₂ Emissions. Carbon Dioxide Information Analysis Center, Oak Ridge National Laboratory, U.S. Department of Energy, Oak Ridge, Tenn., U.S.A .DOI: 10.3334/CDIAC/00001_V2016
7. Pakistan Economic Survey 2011-12, Economic Adviser’s Wing, Finance Division, Government of Pakistan, Islamabad.

OSCHEIUS: A NEW ENTOMOPATHOGENIC NEMATODES

RASHID PERVEZ

Division of Nematology, ICAR-Indian Agricultural Research Institute, New Delhi-110 012

ABSTRACT

A new genus *Oscheius* under the family Rhabditidae, sub-family Rhabditinae, with *O. insectivorus* as its type species proposed by Andrassy in 1976. *Oscheius* was distinguished from other Rhabditinae by its unusually short buccal tube, about as long as wide, and the absence of median pharyngeal swelling. *Oscheius* in the family Rhabditidae and divided into two groups based on the bursa. The first group has a leptoderan bursa and the other group has a peloderan bursa, which comes under insectivora and dolichura group, respectively. The *Dolichura* group comprises *Oscheius guentheri*, which is a species with a reduced posterior-gonadal arm, plus two subgroups, of which two representative species are *Oscheius tipulae* and *O. dolichura*, respectively. Historically, *Oscheius dolichura* was one of the first nematode species described to have an androdioecous mode of reproduction. Nematodes can be considered entomopathogenic if they fulfil the following criteria for entomopathogenicity: bearing a pathogenic bacterium within a dauer (also known as infective) juvenile nematode, releasing the bacterium within the host, active host-seeking, and -penetration by dauer juveniles, rapid insect death, nematode and bacterial reproduction, reassociation of the pathogenic bacteria with new generations of dauer juveniles; and emergence of IJs from the cadaver so that the cycle can be repeated. *Oscheius* is one of the most common nematode species in soil in India also abroad. It is mostly found in the dauer stage. *Oscheius* is an independent genus. Only seven species in Insectivora group including *O. amsactae*, *O. carolinensis*, *O. chongminensis*, *O. microvilli*, *O. niazii*, *O. rugaoensis*, *O. siddiqii* and one species in Dolichura group namely *O. onirici* were recognized as entomopathogenic. Phylogenetic analysis based on ribosomal DNA sequences revealed these two groups are monophyletic. *Heterorhabditoides* was proposed as a new genus, but it was considered as a junior synonym of *Oscheius* and it is in general not accepted as a valid genus. Another species, *Heterorhabditoides rugaoensis*, was also transferred to *Oscheius*.

Keywords: Entomopathogenic nematodes, morphology, taxonomy, *Oscheius*

HYDROPONIC FODDER AS AN ALTERNATE TO CONVENTIONAL GREEN FODDER FOR SUSTAINABLE RABBIT PRODUCTION

SHANMUGA SUNDARAM. A, VENKATARAMANAN, R, RAJKUMAR. K, AND MEENAKSHI SUNDARAM. S

Livestock Farm Complex, Tamil Nadu Veterinary and Animal Sciences University, Madhavaram Milk Colony, Chennai, Tamil Nadu, India – 600 051.

Ever increasing trends in human population warrants nutritional security, economic sustainability and food adequacy. Rabbit rearing is one of the avenues that can give livelihood and food security to rural people. Rabbits are the only micro livestock suitable for rearing by small farmers and landless agricultural labourers with simple housing and management. Quality green fodder is an important input for rabbit production. Cultivation is the main source of green fodder for any livestock enterprise. However, hydroponics, a soilless method of raising crops is used in harsh climates such as deserts, areas with poor soil or in urban areas where high land costs have driven out traditional agriculture. Hydroponic fodder production is probably best suited to semi-arid, arid, and drought-prone regions of the world, suffering from chronic water shortages or in areas where irrigation infrastructure does not exist. This technology might be very important in regions with limited forage production (Fazaeli *et al.*, 2012). It is viable, farmer friendly alternative technology for landless farmers for fodder production (Bakshi *et al.*, 2017). To optimize the

fodder production for rabbits, hydroponic cultivation is an ecofriendly method of growing fodder and hydroponic grown cereals, produce better quality and higher quantity of fodder than conventionally grown cereals (Kide *et al.* 2015). With this background the present study was designed to study the effect of feeding hydroponic maize fodder as a replacement for conventional guinea grass in the growth and reproductive performance of Soviet Chinchilla rabbits.

METHODOLOGY

All experiment protocols were approved by the Tamil Nadu Veterinary and Animal Sciences University. An eight weeks study was carried out at Livestock Farm Complex, Madhavaram Milk colony, TANUVAS, Chennai-51, located between latitudes 12° 9' and 13° 9' N and longitudes 80° 12' 80° 19' E with an altitude of 22 m above MSL. Sixteen numbers of Soviet chinchilla weaned bunnies (comprising of both sex) were selected and divided into two experimental groups. The first group (control) was fed with concentrate diet and guinea grass and the second group (Treatment) was fed with concentrate diet and hydroponic maize fodder. The experimental animals were fed *ad libidum*. All the animal were reared in three tier cages made up of galvanized iron weld mesh under similar management conditions. The concentrate diet was procured from the University feed mill and guinea grass were harvested from the farm. Hydroponic green fodder was produced using the TANUVAS-UIIC- Low-cost hydroponic green fodder machine fabricated at University Innovation and Instrumentation Centre (UIIC), TANUVAS (Rachel *et al.*, 2015). Good quality yellow maize seeds with less than 12% moisture were selected for the hydroponic fodder production. Seeds were washed in tap water to remove chaffs and dirt. The seeds were then soaked in tap water for 20 hours. Later water was drained, and the seeds were kept in gunny bags for 24 hours for germination. After germination, seeds were placed onto different trays and kept on the sprout section of hydroponic green fodder machine. Each tray in the sprout section is provided with two drippers and one sprinkler which sprinkle water in every 1 hour for about 1 minute. The trays were shifted to next rack daily. On the 5th day the tray enters the growth cycle in which each tray is supplied with two sprinklers. After 8 days of total growth period the fodder was ready to feed, which was weighed and then fed to rabbits. The adaptation period of 15 days was provided to the rabbits and Ivermectin as prophylaxis against ecto and endo parasites was given during the start of the trial. Parameters such as weekly body gain and daily feed intake, age at first mating, age at first kindling and litter size at birth were recorded. Accumulated data was analyzed for statistical significance by unpaired ‘t’ test using SPSS software.

RESULTS:

The proximate composition of guinea grass is moisture – 78.06 %, CP – 14.92 %, EE – 3.51 %, TA – 11.89 %, CF – 26.36 % and NFE – 43.32 % and proximate composition of hydroponic green fodder is moisture – 82.27 %, CP – 10.93 %, EE – 4.38 %, TA – 2.98 %, CF – 9.00 % and NFE – 72.71 %. Kide *et al.* (2015) and Naik *et al.* (2015) have observed the nutritional composition of hydroponic maize fodder in the ranges as follows; CP 13.57 -14.56%, CF 10.00 - 10.67%, EE 3.49 - 4.67%, TA 2.83 - 3.84% and NFE 66.72 - 68.47%. The proximate composition of hydroponic fodder observed in the current study was slightly lower with respect to CP and CF but higher in NFE. The variation may be due to difference in variety, geographical location, storage duration, irrigation and days to harvest (Jemimah *et al.*, 2018). The treatment group though had a comparatively better mean value, there was no significant difference ($P \geq 0.01$) with respect to body weight at weaning (g), body weight at end of trial (g), total body weight gain (g) and daily body weight gain (g) in the control and treatment groups. The average dry matter intake (g) was significantly ($P \leq 0.01$) higher in the control group in comparison with treatment group. Even though the hydroponic fed group consumed less feed it could perform on par with conventional green fodder due to the enhanced nutritional value of sprouted grain and increase in quantity and quality of protein, sugars, minerals and vitamin during sprouting (Lorenz, 1980). Mean \pm S.E of Age at first mating (days) was 163.00 \pm 6.23 and 161.40 \pm 15.06; age at first kindling (days) 193.25 \pm 6.41 and 192.40 \pm 15.06; and number of young ones per kindling 2.50 \pm 0.50 and

4.00 ± 0.32; in the control and treatment groups, respectively. Statistical analysis revealed highly significant difference (P ≤ 0.01) in litter size at birth between treatment and control groups. There was no significant difference observed between treatment groups for other reproductive performance parameters like age at first mating and age at first kindling.

Conclusion

This experiment clearly demonstrated that feeding hydroponic maize was on par with guinea grass feeding in Soviet Chinchilla rabbits. The hydroponic maize fed rabbits showed similar body weight gain and better reproductive performance compared with the Guinea grass group. Thus, this study suggests that the hydroponic yellow maize fodder can be suggested as a replacement for conventional fodder in the diet of soviet chinchilla rabbits without any deleterious effect on their growth and reproduction.

References

- Rachel Jemimah E, Gnanaraj PT, Muthuramalingam T, Devi T, Babu M, Sundharesan A (2015). Hydroponic green fodder production-TANUVAS experience.
http://rkvy.nic.in/Uploads/SucessStory/TAMILNADU/2016/2016023524Hydrophonic_Final.pdf
- Jemimah ER, Gnanaraj PPT, Muthuramalingam T, Devi T, Bharathidasan A, Sundaram AS (2018). Growth Performance and Economics of Feeding Hydroponic Maize Fodder with Replacement of Concentrate Mixture in New Zealand White Rabbit Kits. J. Anim. Health Prod. 6(2): 73-76.
- Key Words:** Guinea grass, Hydroponic green fodder, rabbit production, Soviet Chinchilla

Table 1: Growth and reproductive parameters of the soviet chinchilla rabbits (Mean ± S.E)

Parameters	Control	Treatment
	Guinea grass + Concentrate feed	Hydroponic fodder maize + Concentrate feed
Body weight at weaning (g) ^{NS}	717.13 ± 59.41	751.50 ± 82.03
Body weight at end of trial (g) ^{NS}	1563.25 ± 102.15	1792.75 ± 98.82
Total Body weight gain (g) ^{NS}	846.13 ± 129.10	1041.25 ± 92.43
Daily body weight gain (g) ^{NS}	11.92 ± 1.82	14.67 ± 1.30
Average daily dry matter intake (g)**	107.12 ± 1.76	96.09 ± 0.79
Age at first mating (days) ^{NS}	163.00 ± 6.23	161.40 ± 15.06
Age at first kindling (days) ^{NS}	193.25 ± 6.41	192.40 ± 15.06
Number of young ones per kindling*	2.50 ± 0.50	4.00 ± 0.32

Mean of eight observations

Means bearing different superscript in the same row differ significantly

NS- Non significant, *P < 0.05 **P < 0.01

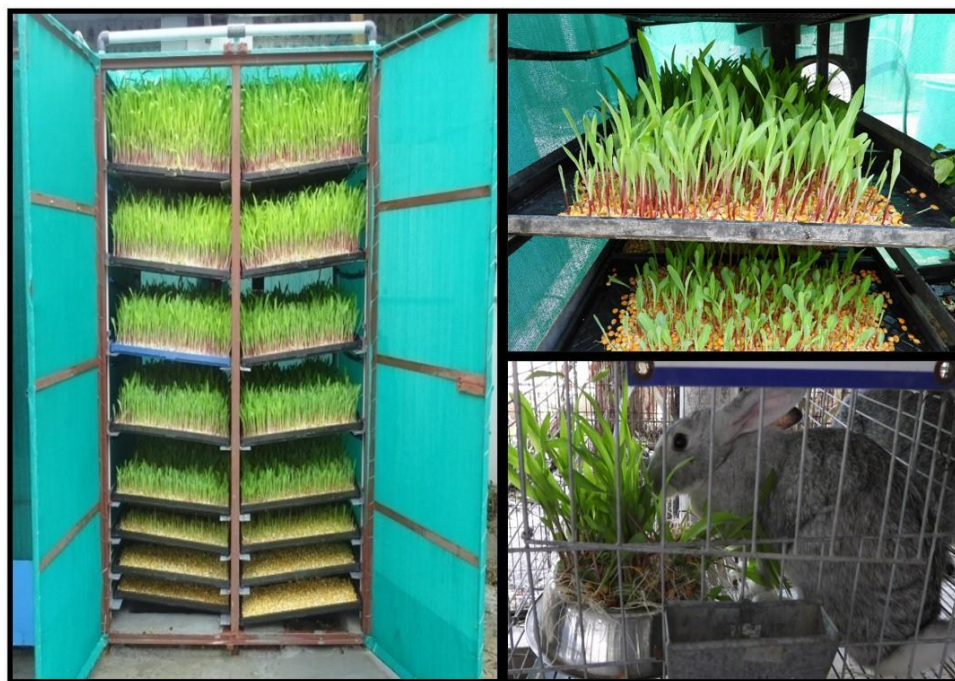

Fig 1 Hydroponic fodder maize production through TANUVAS – UIIC - low-cost hydroponic device

Normal maize protein possesses low nutritional significance to humans because of very limited amounts of major amino acids, such as lysine (1.6–2.6%) and tryptophan (0.2–0.6%) (Moro et al., 1996), which is less than half of the recommended dose specified for human nutrition. Vitamin A deficiency is also one of the serious health issues in developing and low-income countries. Further, the high carotene content of yellow grained maize is considered very useful in imparting yellow colour to egg yolk so is important in poultry industry. However, the cultivation of nutrient-rich maize would be possible only if made agronomically viable. Maize is a gluten free cereal and hence, suitable to produce foods addressed to celiac patients. Maize flour is used to make *chapattis* (Indian flat bread) in a few Northern states of India but maize *chapattis* (*Makki di Roti*) are used as a delicacy with *saag* in Punjab state. The utilization of maize for making *chapattis* shows difficulty as it does not form viscoelastic dough on kneading and hinders its extensive utilization for this purpose. The whole wheat flour supplement with quality protein maize (QPM) can help to combat worrisome situation of malnutrition in Indian masses. Many countries like Brazil, Zimbabwe, Zambia and Ghana use 10 per cent QPM flour in making different food products for reducing protein-energy malnutrition. Inclusion of QPM as alternate cereal in India's public distribution system for poverty ridden class having the least access to quality food, midday meal to children in schools, is the best platform to address malnutrition where maize produce can be plugged in. A set of four PAU bred maize lines with high seed yield potential and of heterotic vigour were transformed into quality maize lines through marker assisted selection and have been registered by Plant Germplasm Registration Committee (PGRC) of Indian Council of Agricultural Research, India on March 29, 2022.

Punjab Agricultural University (PAU), Ludhiana has developed a *desi* type composite JC 4 through modified mass selection from local maize collections of rainfed (*kandi*) region of the state. Analysis for *chapatti* making parameters viz., water absorption of 100 g flour(ml); rollability; diameter (cm); appearance; colour; flavour; texture and taste rated JC 4 as ‘very good’ with overall acceptability eight out of 10.

To analyze the effect of environment on *chapattii* making quality of JC4, a multilocational experiment was conducted in *kharif*, 2019 at PAU, Ludhiana, Punjab (PB) and Bajaura, Himachal Pradesh (HP) and sampled for *chapatti* making quality along with local collections

viz., Dhubri Local, Bajaura makka, Early composite, JC14, Kesari, Megha, Girija, Parbhat and Senji local. Mean sensory score for determining *chapatti* making quality was based on appearance, colour, texture, flavor and taste of *chapattis*. The overall acceptability score based on these features was the highest in JC4 amongst 10 test samples both from Punjab (8.13 ± 0.15) as well as HP (8.20 ± 0.53) samples, though was slightly higher in JC4 samples collected from Bajura. Texture and taste of *chappati* was same but appearance and flavor was slightly higher in JC4 samples from HP. Nutritional profiling recorded JC4 with 9.79% protein; 4.83 oil%; 65.57 % starch; 3.22 β -carotene (ppm) and 0.37 Trp% protein in Punjab samples whereas 8.24% protein; 5.08 oil%; 64.81% starch; 3.86 β -carotene (ppm) and 0.49 trptophan% protein was observed in samples from HP. Under dough characterization, mixing was marked as soft and pliable in both PB and HP samples whereas rolling was ranked good in PB samples and excellent in HP samples of JC4. Mineral content profiling characterized JC4 grain samples with 21.1 Zn(ppm), 0.8 Cu (ppm) 5.35 Mn(ppm), 7934.5 K(ppm), 1293.1 Mg(ppm), 0.5 Se (ppm) and 3826.9 P(ppm) obtained from PB while 28.7 Zn(ppm), 1.0 Cu (ppm), 2.4 Mn(ppm), 6203.8 K(ppm), 887.75 Mg(ppm), 0.15 Se (ppm) and 2806.15 P(ppm) in HP samples. With high suitability for chapatti making, high β -carotene content of orange flint grains of JC4 make it suitable for poultry feed industry too as this is considered very useful in imparting yellow colour to egg yolk.

Maize landraces, retaining a distinct identity and subjected to selection by farmers for generations, are not only a reservoir of large allelic diversity but also rich resource for better adaptation, quality and tolerance to biotic and abiotic stresses. Maize from hilly/kandi regions of India is known to harbour high quality attributes and based on certain environmental and cultural drivers, farmers are retaining and cultivating to some extent. The current social, economic and physical environments are unfavorable for landrace cultivation. We reported the exploration conducted to collect the land races by visiting different farmers/research stations of different districts of Himachal Pradesh and efforts to harness the untapped native diversity to strengthen maize quality program. Collected 17 traditional varieties/land races from Hills (Bharmor, Chobiya, Tunda valley, Saoloni maize from Chamba) and chametli, Khandaghat of Solan district and 20 landraces from Kangra and Una districts of HP and 15 lines from *kandi* belt of Ropar, Hoshiarpur and SBS Nagar districts of Punjab state of India. The lines deciphered extensive variation for grain colour and size. Lines also varied for early vigour, leaf architecture, maturity and grain yield. A selected set of 10 landraces, which exhibited high agronomic potential, were evaluated under organic conditions and under rainfed conditions. Three lines were marked for high yield potential and earliness and hence, can be used for fodder purpose as well.

In legume, sulphur amino acid (Methionine and cystine) is lacking and synthetic methionine is again supplemented along with maize and soyabean. Cysteine (Cys) is not strictly considered an essential amino acid in the diets of animals because it can be synthesized from methionine, but in dietary situations where methionine is limited, cysteine becomes conditionally essential. While providing nutritional requirements to animals, this approach significantly increases the cost of meat production (Waldroup et al., 1981). Breeding new maize varieties with improved methionine levels would mitigate the high cost associated with methionine supplementation and provide a more nutritionally balanced feed and food source. Methionine (Met) is also, an essential amino acid in humans. As the substrate for other amino acids such as cysteine and taurine and the important antioxidant glutathione, Met plays a critical role in the metabolism and health of many species, including humans. It is also an important part of angiogenesis, the growth of new blood vessels. Several studies showed that Met restriction also inhibits aging-related disease processes in mice and inhibits colon carcinogenesis in rats. Loss of Met has been linked to senile greying of hair. Its lack leads to a buildup of hydrogen peroxide in hair follicles, a reduction in tyrosinase effectiveness, and a gradual loss of hair

color. Breeding new maize hybrids with improved Metlevels would mitigate the high cost associated with Met supplementation as cost of one kg synthetic Met is around 400 Rs and to meet the requirement of various ages of broiler, about 100-200 g of synthetic Met is added per quintal of the feed thereby increases the cost of feeding by 40-80 Rs. per quintal. Punjab Agricultural University (PAU) harbors rich genetic reservoir of maize germplasm which comprises inbred lines originated and of diverse background. Owing to strong collaboration with the Indian Institute of Maize Research (IIMR), Ludhiana and CIMMYT, Mexico; PAU also obtained a good stock of CML lines bred for quality, biotic and abiotic stresses. To decipher the variability of Met content in Indian germplasm, a set of 50 lines comprising landraces collected from farmers of different regions, parental lines from different heterotic pools and CIMMYT lines were characterized for methionine content. Single cross hybrids have been developed and analyzed for methionine content to understand the inheritance of complex trait. The hybrids exhibited wide array of variability for this Met content and are under multi-site validation.

Punjab Agricultural University, Ludhiana has developed new cytoplasmic male sterility (CMS) based babycorn hybrid named Punjab baby corn hybrid 1. In Feb., 2022, this hybrid has been approved for release by State Varietal Release Committee for *kharif* season in Punjab. Based on experimental data in trials conducted by different research stations and KVKs of Punjab, this new hybrid exhibited equivalent performance for both yield and quality in comparison to prevalent private sector baby corn hybrid G 5417 (1.93 % yield superiority over the check G 5417). Like G5417, Punjab baby corn1 hybrid is also based on cytoplasmic male sterility (which implies that hybrid does not bear viable pollen grains). So, farmers not need to remove the tassels (detasseling) to get good quality ears. This saves time and labour cost incurred to remove the tassels (as pollination leads to seed set and make it unacceptable as baby corn) during flowering. This is the first CMS based maize hybrid for Punjab state by PAU.

Waxy maize having nearly 100% amylopectin compared 75% amylopectin and 25% amylose in normal maize kernels, is gaining popularity as instant energy source. There is a significant export market for waxy maize in Europe and Asia. Waxy maize lines, developed and maintained at PAU, were analyzed for their heterotic behaviour and utilized for the development of waxy maize hybrids with starch constituting amylose content of 2.03 and amylopectin 59.9 content whereas normal maize with 10.35 amylose and 49.4 amylopectin content. Deep purple and black maize landraces collected from various origins were characterized for total antioxidant activity.

Conclusion: To realize the demand driven potential of maize as ‘the future cereal crop’, a dedicated effort by researchers and holistic support by policy makers is an inevitability. It is necessary to have coupling of strategies and interventions around technological innovations, policy support, marketing linkages, supporting infrastructure and strong public private partnership for economic viability of maize crop. Improvement in the maize value chain across its various stages will be extremely crucial for making Indian maize competitive international market both in terms of quality and prices. The technologies to utilize nutrient-rich maize grains should be developed and disseminated to local small-scale processors, to make functional foods and value-added items. The demand of such nutraceutical products is nowadays increasing with improving living standards, increasing health awareness and urbanization.

EVALUATING THE EFFECT OF COMBINATION OF ESSENTIAL OILS ON RUMEN METHANE PRODUCTION THROUGH *IVGPT*

RAJKUMAR. K^{1*}, KARUNAKARAN. R¹, BHARATHIDHASAN. A¹, TENSINGH GNANARAJ. P² AND VIJAYARANI. K³

Department of Animal Nutrition, Madras Veterinary College, Tamil Nadu Veterinary and Animal Sciences University, Chennai, Tamil Nadu, India – 600 007.

Methane (CH₄) is most crucial Green House Gas (GHGs) as it has soaring global warming potential, short half-life and loss of gross energy which otherwise can be diverted for animal production. Around 2-12 % of a ruminant's energy intake is naturally lost as methane. Ruminants mainly, cattle, buffaloes, goats, and sheep emit CH₄ and altogether represent 96% of the global enteric fermentation source. In the process of assimilating its nutrition from feedstuffs animal produces large quantities of GHGs. Methane is generated by anaerobic fermentation, where bacteria break down organic matter producing hydrogen (H₂), carbon dioxide (CO₂) and methane (CH₄). Several chemicals that inhibit methanogenesis directly have been evaluated for their efficacy to inhibit enteric methane production in ruminants. The chemicals include halogenated hydrocarbons, lipids, and plant compounds such as tannins, saponins and essential oils (EOs) (Hristov *et al.*, 2013). Essential oils (or their major bioactive compounds) such as clove (Eugenol), cinnamon (Cinnamaldehyde), orange peel (Limonene), garlic (Diallyl disulfide) mint (Carvacrol) and thyme (Carvacrol, Thymol) have been evaluated for *in vitro* rumen methane reducer and associated rumen fermentation effect (Patra *et al.*, 2010) and *in vitro* anti methanogenesis bacterial agents (Ohene-Adjei *et al.*, 2008). Methanogenesis decreases with the application of essential oil, especially by trimming down microbial populations. Many researches have tried to evaluate the effect of essential oil in reducing enteric methane emission individually, but only limited studies on effect of combination of essential oils in methane production are available. With this background the present study was conducted to evaluate two essential oils, garlic (*Allium sativum*) and peppermint (*Mentha × piperita*) for their effect on rumen fermentation characters to abate methane production.

Methodology

All experiment protocols were approved by the Tamil Nadu Veterinary and Animal Sciences University. This experiment dealt with of effect of combination of essential oils at identified level on methane production for ruminants in paddy straw-based ration by *in vitro* gas production technique (*IVGPT*). The experiment was conducted in two groups; one with only basal diet (Control) and other with basal diet and Essential oil (Garlic oil 0.65 µl + Peppermint oil 0.25 µl per 30 ml inoculum) (Treatment). The basal diet used for the study had roughage: concentrate mixture ratio of 60:40. The concentrate mixture consisted of 33.5 % maize, 19.5 % soya bean meal, 44.0 % deoiled rice bran, 2.0 % mineral mixture and 1.0 % common salt. The roughage used was paddy straw which was milled to pass through 1.0 mm sieve. The roughage: concentrate mixture was well mixed to form the basal diet. The *invitro* gas production studies were carried out using Hohenheim gas production technique as per the procedure of Menke and Steingass (1988). Methane concentration was estimated by Gas chromatography as per the method of Sitaula *et al.* (1992). The ammonia nitrogen was estimated by steam distillation as per the protocol of Makkar and Becker (1996). The volatile fatty acids in the fermented fluid were estimated as per the method of Chase (1990). The relative quantification of different microbial groups (Whole methanogens, Methanobacteriales, Methanomicrobiales, Methanosarcinales, *Fibrobacter succinogens*, *Ruminococcus albus*, *Ruminococcus flavefaciens*) was done with real time PCR using specific primers for different microbial groups (Denman and McSweeney, 2005).

Results:

The effect of garlic oil (0.65 µl) and peppermint oil (0.25 µl) supplementation on various rumen fermentation characteristics with *in vitro* gas production technique on paddy straw-based diet is presented in table. There was a significant ($P < 0.01$) difference between control and treatment groups in total gas. A reduction of total gas by 16.61 % was observed in the present study. The reduction in methane was 39.17 % less in treatment group compared to the control. The mode of action of essential oils in methane reduction may result from either reduction of methanogens directly or reduction in hydrogen ions production due to decreased acetate and butyrate production (Kumar *et al.* 2014). There was a significant ($P < 0.01$) difference between control and treatment group in percentage of methane on total gas production, and methane production per 100 mg truly digested substrate. Methane production per 100 mg truly digested substrate depends upon the methane production and digestibility of the feed. The methane production reduced significantly ($P < 0.01$) in treatment group but digestibility did not differ. No significant ($P > 0.01$) change was observed between the control and treatment group in the ammonia nitrogen production by *IVGPT*. The ruminal ammonia concentration signifies the balance that is maintained between protein degradation in the rumen and loss of ammonia due to consumption of rumen bacteria (Nolan and Dobos, 2005). A significant ($P < 0.01$) decrease in acetate production and increased propionate production was observed in the treatment group compared to control. Acetate and butyrate synthesising pathways are hydrogen producers and propionate pathway is hydrogen consumer and therefore an increase in propionate production is generally associated with a decrease in methane emission (Russell, 1998). There was no difference in the acetate to propionate ratio of ruminal fluid between the control and treatment groups. There was no significant ($P > 0.01$) difference between control and treatment groups in abundance of rumen methanogens such as *Methano microbiales*, *Methano sarcinales* and rumen fibrolytic bacteria such as *Ruminococcus flavefaciens*, *Fibrobacter succinogens*, *Ruminococcus albus*. Essential oils may affect methane production by directly inhibiting the growth and activity of methanogenic microbes or indirectly by decreasing the number of protozoa associated with methanogens (Cieslak *et al.* 2013). It has been hypothesized that some of the organosulfur compounds present in garlic oil may particularly inhibit SH-containing enzymes essential for metabolic activities, especially the synthesis of specific isoprenoid side chains in archaeal lipid (Busquet *et al.*, 2006).

Conclusion

This *IVGPT* experiment clearly demonstrated that supplementation of EOs in combination of garlic oil and peppermint oil have potential effect on reduction of methane production. Also, they do not have any adverse effect on the rumen fermentation characteristics. Therefore, supplementation of essential oils as a methane mitigation strategy at farm level in ruminants could be explored with further studies on quantification, effect on productivity, cost-benefit ratio etc.,

References

- Makkar, H.P.S. and K. Becker, 1996. Effect of pH, temperature and time on inactivation of tannins and possible implications in detannification studies, *Journal of Agricultural and Food Chemistry*, 44: 1291-1295.
- Menke, K.H. and H. Steingass, 1988. Estimation of the energetic feed value obtained from chemical analysis and *in vitro* gas production using rumen fluid. *Animal Research and Development*, 28: 7-55.

Keywords: Essential oil, garlic oil, *IVGPT*, methane mitigation, peppermint oil

Table 1: Evaluating the effect of essential oils in combination on rumen methanogens and rumen fibrolytic bacteria (Mean ± S.E)

Rumen fermentation parameters	Control	Treatment
	Basal feed	Basal feed + (Garlic oil 0.65 µl + Peppermint oil 0.25 µl per 30 ml inoculum)
Rumen Characteristics		
Total gas (ml / 200 mg) **	32.08 ^a ± 0.34	26.75 ^b ± 0.30
Methane (ml / 200 mg) **	7.29 ^a ± 0.17	4.44 ^b ± 0.05
Percentage of methane in total gas **	22.74 ^a ± 0.52	16.59 ^b ± 0.16
Methane / 100 mg of truly digested substrate (ml)**	7.03 ^a ± 0.16	4.39 ^b ± 0.05
<i>In vitro</i> true dry matter degradability (%) ^{NS}	51.83 ± 0.55	50.48 ± 0.45
Ammonia nitrogen (mg %) ^{NS}	24.13 ± 0.34	24.80 ± 0.23
Acetate (mol %) **	62.31 ^a ± 1.21	55.69 ^b ± 0.78
Propionate (mol %) *	27.88 ^b ± 1.40	32.78 ^a ± 0.81
Butyrate (mol %) ^{NS}	9.81 ± 0.69	11.53 ± 0.47
Acetate: Propionate ratio **	2.27 ^a ± 0.15	1.71 ^b ± 0.07
Microorganism	Abundance (log₁₀ no. of copies of gene/ml)	
Rumen methanogens		
Whole methanogens**	5.78 ^a ± 0.18	4.20 ^b ± 0.10
<i>Methano microbiales</i> ^{NS}	2.11 ± 0.23	1.84 ± 0.18
<i>Methano sarcinales</i> ^{NS}	2.42 ± 0.31	2.07 ± 0.20
<i>Methano bacteriales</i> **	3.93 ^a ± 0.22	2.51 ^b ± 0.19
Rumen fibrolytic bacteria		
<i>Ruminococcus flavefaciens</i> ^{NS}	4.38 ± 0.34	4.03 ± 0.38
<i>Fibrobacter succinogens</i> ^{NS}	3.18 ± 0.13	2.73 ± 0.43
<i>Ruminococcus albus</i> ^{NS}	5.55 ± 0.32	4.87 ± 0.23

Mean of six observations

Means bearing different superscript in the same row differ significantly

NS- Non significant, *P < 0.05 **P < 0.01

Fig 1 Effect of supplementation of garlic oil and peppermint oil in combination on *in vitro* gas production study (Control was considered as 100 %)

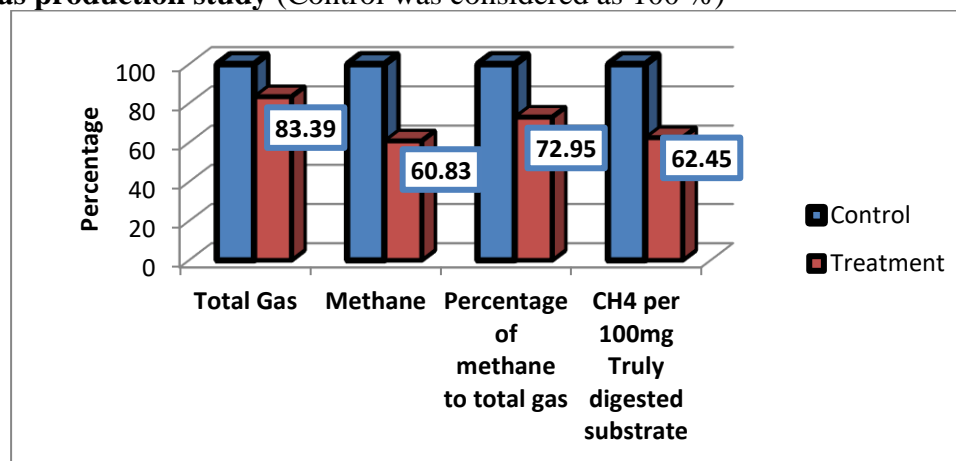

COSTS AND BENEFITS OF TWO OIL PALM PLANTATIONS LOCATED IN UGANDA AND MALAYSIA

BONNY KAYONDO, MOHAMADU BOYIE JALLOH, IIMAS ABDUROFI, NUR AAINAA BINTI HASBULLAH, PARAMANANTHAN SELIAH
Faculty of Sustainable Agriculture, Universiti, Malaysia Sabah

Purpose

Oil palm is an adaptable crop grown in diverse tropical environments. However, its optimal productivity is constrained by prevalence of poor soils, weak agronomic practices and environmental constraints common in Africa. Therefore, to increase its productivity and efficiency in such areas requires extra costs to match yields obtained in ideal environments and well-managed commercial plantations found Malaysia. High yields reduce the cost of production, which is a key to compete in a commodity-based market. In this study, we aim to determine the economic feasibility of the two oil palm plantations.

Methods

Cost benefit analyses were used with the Input-Output Ratio measurement. Secondary oil palm fresh fruit bunch and crude palm oil production data from 2016 to 2021 from the two plantations was used. Total revenue, total variable costs and total fixed costs were computed using the CBR formula.

Results

Generally, the average CBR results of 1.07 show that the plantation investment in Uganda is 62% economically more rewarding than the plantation in Malaysia. However, in 2017, the lower CBR of 0.23 for the plantation in Uganda compared to 0.34 for that in Malaysia was because of the low yields caused by drought impact experienced in 2016.

Conclusions

Cost benefit analysis results obtained from plantation in Africa imply that investment in soil fertility and water conservation increases oil palm production and land productivity. Policy makers in the oil palm sector should therefore consider expanding the commercial oil palm industry in Uganda.

Key words: Costs, benefits, oil palm, soils, agronomic practices.

ASSESSMENT OF RESILIENCE IN RELATION TO PHYSIOLOGICAL AND BEHAVIOURAL PATTERNS OF PREPARTUM THARPARKAR (*Bos indicus*) AND VRINDAVANI CROSSBRED COWS UNDER TROPICAL CLIMATIC CONDITION

VANDANA¹, BRIJESH KUMAR², MUKESH SINGH¹, G.K. GAUR¹, KALPENDRA KOHLI², PRADEEP CHANDRA², MED RAM VERMA³ AND TRIVENI DUTT¹

1-Livestock Production and Management Section,

2- Animal Reproduction Division,

3- Livestock Economics, Statistics and Information Technology

ICAR-Indian Veterinary Research Institute, Izatnagar, Bareilly-243122 U.P. INDIA

The dairy cows are vulnerable throughout the calving period, and the calving event itself is physically stressful and painful and the postpartum period is linked with various physiological changes and increased risk of metabolic and production diseases. Managemental practices are associated with good husbandry, such as identification and data collection in dairy cows at or near parturition are required so that the attending caretaker can intervene as effectively as possible. Individual watching is required to identify pre-calving complications or health problems as early as possible. Increased restlessness and isolation seeking have been defined as signs of imminent calving. In recent studies, several behavioral changes have been observed

when the cow is close to parturition, i.e., a few days to a few hours before parturition, cows exhibit restlessness like increased walking, pawing the ground, lying bout, licking the flanks, and swishing the tail. The duration of maintenance behaviors like eating, ruminating, and grooming reduces in the days leading up to calving. Combined data of individual monitoring and data obtained via Closed-circuit television may be useful tools to predict the time of calving. The peri-parturient behavior of cattle has been studied by various workers. However, the information on peri-parturient behavior in Indian local breeds and crossbreds are very scarce.

Objective

The objective of the present investigation to identify the resilient traits and also to document differential quantified prepartum behaviours between Tharparkar and Indian crossbred cows.

Methodology

The present study was carried out at Cattle and Buffalo Farm, Livestock Production and Management Section, Indian Veterinary Research Institute, Izatnagar, U.P. India. The institute is located at an altitude of 568 ft above the mean sea level at latitude of 28.22° N, and longitude of 79.22° E. The climatic condition of the place touches both the extreme viz. cold (approximately 5°C in winter) and hot (approximately 45°C in summer). The relative humidity ranges between 15 and 85 percent & average rainfall about 90 to 120 cm.

Observations were made during the months of (June, 2020 to May, 2021) on a total of 40 animals comprising 20 Vrindavani (Crossbred) and 20 Tharparkar (Indigenous). All 40 animals were reared under a loose housing system. After 6 to 9 months of pregnancy, all the animals were fed *ad-lib* green fodder two times daily in the morning and evening along with 3 kg concentrate (16% CP and 70% TDN) at 10'o clock in the morning.

Behavioral Observations

For observing the various pre parturient behaviours of dam, video recording was done with a low light-intensity camera and a time-lapse digital video recorder (HIK VISION, TURBO HD DVR). Four cameras were fit in the calving pen (two dome types and two bullet type) and one camera was also placed in open paddock. 40 W fluorescent lamps were installed in calving pen to facilitate behavioural data recording at night.

Results

The prepartum standing time was significantly high 12 hr before parturition compared to any other day of prepartum in both breeds. Similarly, lying time and lying bouts duration were significantly low and lying bouts significantly high 12 hr before calving compared to any other observational day in both the breed. The number of transitions between standing and lying, as well as the amount of time spent walking, are both signs of restlessness significantly more in Vrindavani cattle as compare to Tharparkar. In conclusion, Vrindavani cow showed more restlessness as compared to Tharparkar cattle.

Lateral recumbency is significantly high 12 hr prepartum in Tharparkar cow as compared to crossbred Vrindavani that indicate Tharparkar cows were comparatively comfortable condition than the Vrindavani cow . However, there was no significant difference in lateral recumbency of Vrindavani cow on different observation days of prepartum. Further, lateral recumbency was significantly high in Tharparkar cows 12 hr before prepartum. In both breeds, semi-lateral recumbency 12 hr before prepartum was significantly low at 12 hr before prepartum compared to any other observational day.

Self-grooming time and self-grooming frequency/bouts were significantly high 12 hr before parturition compared to any other observational day in both the breed. However, at 12 hr before parturition, self-grooming time and self-grooming bouts were significantly low in Tharparkar cows as compared to Vrindavani cows. In the present study, a large proportion (more than 90%) of cows exhibited significantly increased self-grooming time and frequency of self-grooming at 12 hr before parturition in Vrindavani cattle as compared to

Tharparkar cattle. Similar findings were reported by Jensen *et al.* (2012) and Lange *et al.* (2017); they observed that during the final 12 h prior to calving, multiparous cows frequently turned their head toward their abdomens, behavior that increased during the final two hours prior to calving and typically occurred during contractions. Rumination time decreases a week before parturition and is numerically very low at 12 hr before parturition as compared to any other day of prepartum.

Vrindavani cows showed more intense restlessness behaviour (67.85%) compare to Tharparkar cows. Some preparturient behaviours were more promptly shown by Vrindavani cows like active ingestion of amniotic fluid, watching back to abdomen, vocalization than Tharparkar cows. Further both the breed prefer isolation during calving and also both the breed start showing restlessness sign some 120 min. before calving and in and around 100 min starts showing intermittent abdominal contraction. However, onset of intense and regular straining starts some 30 to 40 min. before parturition. It was also reported that posture transition during parturition more in Vrindavani cows than Tharparkar cows. Majority of Tharparkar cow deliver their calf in lying position while Vrindavani cow upto expulsion of hip they usually lying down thereafter they stand and foetus come out. Score of teat filling more pronounced in Vrindavani cattle than Tharparkar cows. Some of the common symptoms of parturition like liquefaction of cervical seal, relaxation of sacrosciatic ligaments reached to almost normal non pregnant stage much earlier in Tharparkar cows than Vrindavani. Pregnancy fattening was more obvious in Tharparkar cows than Vrindavani cows. It was reported that Vrindavani cows were more attracted towards amniotic fluid, placenta than Tharparkar and also placentophagia more in Vrindavani cow than Tharparkar cows.

Majority of the Vrindavani cows showed obtuse angle as compare to Tharparkar and also near 40 percent of Vrindavani cow exhibited tail switching during approaching calving. However, 10 percent of Tharparkar cows exhibited tail switching. Vulvar relaxation/ oedema were one of the important impending sign of parturition, it was more pronounced with higher vaginal relaxation score in Tharparkar cattle as compare to Vrindavani. Distance between dorsal to ventral commissure, width of vulva, width of single lips were significantly higher in Tharparkar cows as compare to Vrindavani cows. The cortisol level were recorded lower in Tharparkar cow however, respiration rate was significantly high a week before calving and also near the calving in Vrindavani crossbred cows as compare to Tharparkar.

Conclusion

In conclusion Vrindavani cow showed more restlessness, posture transition, tail switching, higher respiration rate, higher cortisol level than Tharparkar cows. The Vrindavani cow more attracted to placental fluid and higher degree of placentophagia than Tharparkar cows.

REFERENCES

- Rørvang, M.V., Nielsen, B.L. and Herskin, M.S.2018. Prepartum maternal behavior of domesticated cattle: a comparison with managed, feral, and wild ungulates. *Front Vet Sci.* 5:1–11.
- Proudfoot, K.L. 2019. Maternal Behavior and Design of the Maternity Pen. *Vet Clin Food Anim.* 35: 111–124.

COMPARATIVE STUDIES ON VARIOUS PHYSICAL AND SUCKLING ACTIVITIES OF VRINDAVANI AND THARPARKAR CALVES DURING INITIAL 6 HR AFTER CALVING UNDER FLOOR ENRICHED WITH RUBBER MATTRESS

VANDANA¹, BRIJESH KUMAR², MUKESH SINGH¹, G.K. GAUR¹, PRADEEP CHANDRA²,
KALPENDRA KOHLI², S.K. SHANDILYA⁴, MED RAM VERMA³ AND TRIVENI DUTT¹
1-Livestock Production and Management Section, 2- Animal Reproduction Division, 3-
Livestock Economics, Statistics and Information Technology, 4 CSSS(PG) college Meerut
ICAR-Indian Veterinary Research Institute, Izatnagar, Bareilly-243122 U.P. INDIA

A calf's first effort to stand and consume colostrum is often misdirected and clumsy, typically requiring numerous attempts to stand, walk, locate the udder, and grasp the teat. However, if the calf is able to stand, the dam will often use a series of positioning and grooming techniques to redirect and encourage her calf to successfully locate the udder. Calves should consume colostrum by 4 h after birth to allow adequate time for gastrointestinal absorption of colostrum IgG. Good newborn vigour is a vital survival characteristic that promotes behaviours necessary for survival such as colostrum consumption, enhances welfare and ensures vitality. Therefore, calves that consume colostrum by 4 h after birth should be considered “vigorous” by definition.

A detailed understanding of the behavior of the dam and calf is a necessary prerequisite for improving welfare and management during the periparturient period. During the periparturient period the activities of the dam and calf are in a highly dynamic state with many behavioural changes occurring. These changes need to be understood in order to improve management practices and the welfare of the cow and calf during the periparturient period.

In view of the dearth of information regarding the periparturient behaviour of crossbred and indigenous cattle and their calves and the apparent importance of this facet of behaviours in the field of calf welfare and survival it was, therefore, proposed to study comparative calves behaviours of both the breed.

Objective

The objective of the present investigation to study various physical and suckling activities of Vrindavani crossbred calves and Tharparkar calves during initial 6 hr after calving under floor enriched with rubber mattress.

Methodology

The present study was carried out at Cattle and Buffalo Farm, Livestock Production and Management Section, Indian Veterinary Research Institute, Izatnagar, U.P. India. The institute is located at an altitude of 568 ft above the mean sea level at latitude of 28.22° N, and longitude of 79.22° E. The climatic condition of the place touches both the extreme viz. cold (approximately 5°C in winter) and hot (approximately 45°C in summer). The relative humidity ranges between 15 and 85 percent & average rainfall about 90 to 120 cm. Observations were made during the months of (November, 2020 to February, 2021) on a total of 40 calves comprising 20 Vrindavani (Crossbred) calves and 20 Tharparkar (Indigenous) calves.

Behavioral Observations

For observing the various post parturient behaviours of dam and calves video recording was done with a low light-intensity camera and a time-lapse digital video recorder (HIK VISION, TURBO HD DVR). Four cameras were fit in the calving pen (two dome types and two bullet type) and one camera was also placed in open paddock. 40 W fluorescent lamps were installed in calving pen to facilitate behavioural data recording at night.

Results

The Head lifting time of was found non-significantly higher in Tharparkar calves i.e. 146.32 ± 30.95 sec compare to Vrindavani cross bred calves i.e. 102.85 ± 24.49 sec. Head lifting time

non significantly higher on floor enriched with rubber mattress compared to pucca floor in Vrindavani calves. Tharparkar calves took non significantly higher time in head raising on pucca floor as compared to floor enriched with rubber mattress. After raising the head, calves generally moved from lateral recumbency to sternal recumbent position. Non-Significant difference was observed in Vrindavani and Tharparkar calves in sternal recumbency time. Non-significant difference was found on pucca and floor enriched with rubber mattress in sternal recumbency time in Vrindavani calves as well as in Tharparkar calves irrespective of floor enrichment.

Initial attempts of calves to stand included first lifting the hindquarters and thereafter attempting to lift the forequarters. The first attempt to stand did not vary significantly between the breed though the interval from delivery of the calf to first attempts to stand was non significantly longer in Tharparkar calves compared to Vrindavani cross bred calves. Non-significant effect of rubber mattress was seen in 1st attempt to stand (min) in Vrindavani calves. Non-significant difference was seen in 1st attempt to stand (min.) in between pucca and floor enriched with rubber mattress in Tharparkar calves.

Vrindavani calves made more attempts to stand compared to Tharparkar calves i.e. 19.07 ± 1.98 and 12.92 ± 1.12 number, respectively. Standing attempts was significantly higher on pucca floor as compared to floor enriched with rubber mattress at ($P < 0.05$) level of significance in Vrindavani cow. There was not found significant difference of pucca and rubber mattress enriched floor on standing attempt (no.) in Tharparkar calves after calving. The time of first successful standing was non-significantly lower in Vrindavani cross bred calves as compared to Tharparkar calves. Non-significant effect of floor enrichment was seen in Vrindavani cow on 1st successful standing. Non-significant difference was seen in 1st successful standing (min.) in between pucca and floor enriched with rubber mattress in Tharparkar calves. After calving standing time of Vrindavani cross bred calves and Tharparkar calves with in an initial 6 hour was found 135.32 ± 5.52 and 143.53 ± 3.41 min respectively. There was significant higher standing time found in Tharparkar calves after calving with in 6 hrs at ($P < 0.01$) level of significance compared to Vrindavani cross bred calves. Non-significant effect of floor enrichment was seen in total standing time of calf (min) in Vrindavani cross bred calves. There was not found significant difference of pucca and rubber mattress enriched floor on standing time of calf (min.) in Tharparkar calves after calving. Various suckling activities by Vrindavani and Tharparkar calves were analyzed and found no significant difference in various suckling activities except birth to teat contact time, 1st suckling spell, and number of suckling bouts significantly low in Vrindavani calves as compare to Tharparkar calves. There was no significant difference at birth between the breed however Vrindavani calves slightly heavier than Tharparkar calves.

Conclusion

In conclusion, there is no significant effect of floor enrichment with rubber mattress on physical activities and calf suckling behaviours of Vrindavani and Tharparkar calves and also there was no very notable effect of floor enrichment with rubber mattress in the physical activities and suckling behaviours of calves of both the breed. However it was noted that after birth Vrindavani calves were more active in physical activities and suckling activities compared to Tharparkar calves.

References

- Das, S.M., Redbo, I. and Wiktorsson, H. 2000. Effect of age of calf on suckling behaviour and other behavioural activities of Zebu and crossbred calves during restricted suckling periods. *Appl. Anim. Behav. Sci.* **67**: 47–57.
- Riley, D.G., Chase, C.C., Jr., Olson, T.A., Coleman, S.W. and Hammond, A.C. 2004. Genetic and nongenetic influences on vigor at birth and preweaning mortality of purebred and high percentage Brahman calves. *Journal of Animal Science.* **82**: 1581-1588.

SERUM AMH CONCENTRATION AS A POTENTIAL PREDICTOR OF TOTAL ANTRAL FOLLICLE POPULATION, SUPEROVULATORY RESPONSE, AND EMBRYO QUALITY IN SAHIWAL CATTLE

PRADEEP CHANDRA, BRIJESH KUMAR^{A*}, SUSHOBHIT SINGH, KALPENDRA KOHLI, VANDANA, BHAGIRATHI, KURHE ROHIT SATISH, ATHIDI LOKAVYA GANGULA, S.K SINGH, HARENDRA KUMAR AND K. NARAYANAN

Division of Animal Reproduction, ICAR-Indian Veterinary Research Institute, Izatnagar, Bareilly-243122 U.P. INDIA

Superovulatory treatment and response are highly variable and it is considered the most important limitation for embryo production *in vivo* or *in vitro*. In earlier days, the only method to evaluate the number of follicles for predicting superovulatory response is Ultrasonography. Different biomarkers are also having some importance in assessing the response of ovaries to gonadotropins. Recently, research has been centered on the Anti-Mullerian hormone (AMH), the knowledge of the antral follicle population (AFP) by assessing AMH concentration in plasma, would be helpful in predicting the response to gonadotropin treatment and embryo recovery in embryo transfer programs. Recently, AMH has been reported to be a reliable endocrine marker of the population of healthy follicles in bovine ovaries and fertility status in the dairy cow. Cattle with reduced follicle counts exhibit poor ovarian reserve, oocyte quality, and fertility but in contrast, a few studies have found no link between circulating AMH and fertility. The population of healthy 3–7mm diameter follicles, which is the main target of superovulatory treatment, contributes considerably to plasma AMH concentrations and it has been proposed that AMH plasma levels measured before treatment may help to predict the superovulatory response. The measure of antral follicle population of the ovary is a phenotypic attribute related to female fertility and also closely related to both *in vivo* and *in vitro* embryo production.

Objective: To elucidate the relationships between AMH, AFP, superovulatory response, and embryo quality in Sahiwal cattle.

Methodology:

The study included ten apparently normal and healthy non-pregnant cyclic Sahiwal cows (n = 10) ages ranging from four to five years and weighing 419.71±0.19 kg mean (SEM) body weight and 60 to 95 days of lactation. Animals were raised at Cattle and Buffalo farm, LPM Section, ICAR- Indian Veterinary Research Institute, Izzatnagar, U.P. India. Ovaries of cows were assessed by real-time transrectal USG (Exago ECM, France) with a 7.5-MHz per rectal probe to monitor the cows which were given superovulatory treatment, the serum AMH concentration was estimated and its relationship with the antral follicle population (AFP) and superovulatory response was assessed.

After assessing antral follicle count on the day of estrus the donors were superstimulated on the tenth day of the cycle by administering STIMUFOL® (containing pLH 100 g and pFSH 500 g, manufactured by Replibiol SPRL, Belgium) a total dose of 240µg in eight separate doses in a tapering pattern (90, 70, 50, 30 µg) morning and evening. Prostaglandin was given on the twelfth day of the cycle, with the 5th dosage of pFSH. At superstimulatory estrus (SOE) (i.e., 14th day) all donors were inseminated using two straws three times at intervals of 12 hours with quality frozen-thawed semen.

Immediately after blood collection the samples were centrifuged at 3000 rpm for 5 minutes and the serum was separated and stored at -20°C until use for estimation of AMH.

All data pertaining to follicular, luteal counts, number of embryos, and the concentration of AMH have been presented as mean ± SEM. The metric variables were statistically assessed

using the SPSS software package for Windows (version 20.0) and (JMP 9.0) using paired ‘t’-test, unpaired ‘t’-test, within the groups and between the groups.

Results

a. Serum AMH concentration (pg/ml) during estrus, superovulatory period, and day of flushing in Sahiwal cows

On the basis of the antral follicle counts, the Sahiwal cows were categorized into two groups low (< 17 follicles i.e., group A) and high (>17 follicles i.e. group B), the average AMH concentration (pg/mL) of all animals in Group A (n=4) is 153.56±6.98, and Group B (n=6) is 253.35±10.93 (Table 1). The serum AMH concentration (pg/mL) was not affected by the phase of the estrous cycle and different days of superstimulatory protocol, viz; at estrus (158.69±32.58), day of initiation of superovulatory treatment (168.84±34.87), day of superovulatory estrus (150.99±33.25) and day of flushing (135.7±36.54) in group A. Similarly, in group B also the serum AMH concentration did not differ across the periods and the levels were 253.91±51.72, 281.55±49.09, 249.57±51.92 and 228.37±54.15 pg/mL at estrus, day of initiation of superovulatory treatment, day of superovulatory estrus and day of flushing, respectively. However, a lesser variation in serum AMH concentration was detected in individual cows at different phases of the estrous cycle and superstimulatory protocols. Therefore, to determine a logical AMH concentration of each individual cow, the average concentration of AMH from four time periods was calculated in each group and statistically analyzed further to achieve the relationship with antral follicle count, CL number, embryo recovery and transferable embryo.

b. Relationship of serum AMH concentration (pg/mL) with antral follicle population, corpus luteum, and quality of embryo recovered in Sahiwal cows

The serum AMH concentration (pg/mL) in group B animals was significantly higher (253.35±10.93, P<0.005) than in the animals of group A (153.56±6.98). The antral follicle population in group A (13.75±1.10) and in group B (38.33±7.78) was correlated with AMH, and differed significantly (P<0.05). The number of large follicles at superovulatory estrus was significantly high in group B than in group A (17.33 vs 6.75). Similarly, the total number of CL and both recovered embryos as well as transferable embryos (excellent and good quality) were significantly (P<0.05) greater in group B as compared to group A. Different quality embryos recovered in both low and high AMH groups were presented in.

Conclusion

This study reports a strong positive association between AMH with AFP, superovulatory response and embryo quality in Sahiwal donor cows, hence it can be a good indicator of the ovarian pool and quality embryo recovery. The serum AMH concentration is highly repeatable when taken on different days of estrus and superovulatory protocol so can be a reliable predictor for a long period. The measure of AMH before superovulatory treatment might be a good indicator of antral follicle population, superovulatory response and quality embryo recovery. Therefore, future of the ET market would greatly benefit from the capacity to select quality donors for efficient embryo production.

References

- Alward, K.J., and Bohlen, J.F., 2020. Overview of Anti Müllerian hormone (AMH) and association with fertility in female cattle. *Reproduction in Domestic Animals*, 55, 3-10
- Shehabeldin, a. and El-keraby, f., 2021. Anti-Müllerian Hormone (AMH) as endocrine marker for embryo production in superovulated friesian cows. *Egyptian Journal of Animal Production*, 58(1), pp.9-19.

MORPHOLOGICAL VARIABILITY IN *Hibiscus cannabinus* DUE TO IONIZING IRRADIATION (CO⁶⁰), AND ESTIMATION OF GAMMA-RAY LETHAL DOSE 50 (LD₅₀) FOR MUTATION BREEDING

MD. MUKUL MIA^{1*}, MD. HARUN OR RASHID¹, IFFAT JAHAN NUR, MD. FIROZ MORTUZA³, ARIFATUN NAHAR³, MD. GOLAM MOSTOFA¹, NARGIS AKTER²

¹Breeding Division, Bangladesh Jute Research Institute (BJRI), Manik Mia Avenue, Ministry of Agriculture, Dhaka, Bangladesh.

²Director (Agriculture), Bangladesh Jute Research Institute (BJRI), Manik Mia Avenue, Ministry of Agriculture, Dhaka, Bangladesh.

³Institute of Food and Radiation Biology, Bangladesh Atomic Energy Commission, Ganakbari, Savar, Dhaka, Bangladesh.

ABSTRACT

Kenaf (*Hibiscus cannabinus* L.) is an economically important fibre crop originated from Africa, and used in making animal feeds, fodder, clothes, bio-plastics, paper pulp and fibre based industrial products. It is very important to develop improved kenaf varieties due to its commercial values of industrial uses. Kenaf plant have low genetic diversity due to its self-pollination nature. So, efforts should be given to increase the genetic diversity of kenaf. Gamma ray mutation (ionizing radiation) has been used widely and proven to be effective as an alternative method of increasing the genetic diversity, fibre yield and qualities kenaf plant. The latest variety of kenaf developed by BJRI named BJRI Kenaf 4 (KE-3) having red stem, brownish green palmate leaves, petiole with red upper surface, waterlog tolerance, quick growing and high fibre yielding (2.8-3.3 t ha⁻¹) nature has been used for chronic gamma irradiation at Gamma Source Unit of Institute of Food and Radiation biology, Bangladesh Atomic Energy Commission, Dhaka, Bangladesh. Delivered irradiation dose has been measured using Fricke and Ceric-cerous dosimetry systems, and the irradiation doses were applied @ 17.10 Gy minute⁻¹ with a dose uniformity ratio (DUR) of 1.13. Kenaf seeds (100g) were irradiated with 0.0, 100, 200, 300, 400, 500, 600, 700, 800, 900, 1000, 1100 & 1200 Gy dose and irradiated seeds along with control were planted immediately in research field of BJRI at Manikganj and Dhaka. Seed germination percentages were recorded for each doses up to five days. Higher plant height, stem girth and morphological variations were observed at accumulated dose of 200 Gy, and 50% plants were died at accumulated dose of 305 Gy which indicates lethal dose (LD₅₀) for Kenaf plant. This finding will be useful in determining the most suitable dose rate for chronic gamma irradiation for Kenaf plant improvement in future.

Keywords: Gene mutation; *Hibiscus cannabinus*; Irradiation; LD₅₀; Mutation breeding; Physical mutagen

SCREENING OF SALT-TOLERANT TOSSA JUTE GENOTYPES AT GERMINATION STAGE IN SAND-BASED PETRI-PLATES, AND GENETIC ANALYSES OF YIELD ATTRIBUTING MORPHOLOGICAL TRAITS

MD. MUKUL MIA^{1*}, NARGIS AKTER²

¹Breeding Division, Bangladesh Jute Research Institute (BJRI), Manik Mia Avenue, Ministry of Agriculture, Dhaka, Bangladesh.

²Director (Agriculture), Bangladesh Jute Research Institute (BJRI), Manik Mia Avenue, Ministry of Agriculture, Dhaka, Bangladesh.

ABSTRACT

More than 30% of the cultivable land in Bangladesh is in the coastal area. Out of 2.86 million hectares of coastal and off-shore lands, about 1.056 million ha of arable lands are affected by varying degrees of salinity. Tossa Jute (*Corchorus olitorius* L.) is an eco-friendly and qualitative natural fibrous crop having commercial importance of its phloem fibre in industries for textiles, eco-friendly sonali bag, clothes, etc. Jute (Pat) cultivation is hampered due to salt stresses in soil and/or water in southern regions of Bangladesh. Screening and genetic analyses of salt-tolerant jute genotypes is a prerequisite for the breeders to develop salt-tolerant high yielding varieties. Bangladesh Jute Research Institute has developed two white jute (*C. capsularis* L.) varieties named BJRI Deshi Pat 8 and BJRI Deshi Pat 10 tolerant to 10 dSm⁻¹ and 12 dSm⁻¹ salinities, respectively. But, till now no salt tolerant variety of tossa jute has been developed. In this regard, 200 tossa jute germplasms were collected from the Gene Bank of BJRI, and allowed to germinate in sand-based petri-plates supplied with 12 dSm⁻¹ salinity. Among these, 70 genotypes were germinated having low mortality rate which were grown again in earthen pots for morphological characterization. At 105 days old, good results were found for plant height in the accession Acc. 1148 (4.01m), Acc. 1098 (3.61m), Acc. 1193 (3.54m), Acc. 1511 (3.49); girth of stem in Acc. 1098 (27.03mm), Acc. 1193 (23.13mm), Acc. 1749 (21.97mm), Acc. 4719 (21.33mm), Acc. 1148 (20.93mm), Acc. 3736 (20.17mm); bark thickness in Acc. 4719 (8.31mm), Acc. 1098 (4.03mm), Acc.4584 (3.19mm), Acc. 1193 (3.15mm); green fibre weight in Acc. 1098 (360g), Acc. 1193 (182.78g), Acc. 1749 (168.06g), Acc. 1148 (140.67g). Regarding these morphological characters, Acc. 1148, Acc. 1098, Acc. 1193, Acc. 1749, Acc. 4719, Acc. 3736 were found good performer. These genotypes would be grown and used as parents in hybridization techniques or molecular approaches for high yielding salt-tolerant tossa jute variety development in future.

Key words: *C. olitorius*; *C. capsularis*; Hybridization; Jute fibre; Jute morphology; Salinity tolerance

IONIZING IRRADIATION (CO⁶⁰) OF *Hibiscus sabdariffa* FOR MORPHOLOGICAL VARIABILITY, AND ESTIMATION OF GAMMA RAY LETHAL DOSE 50 FOR MUTATION BREEDING

MD. MUKUL MIA^{1*}, MD. HARUN OR RASHID¹, IFFAT JAHAN NUR, MD. FIROZ MORTUZA³, ARIFATUN NAHAR³, MD. GOLAM MOSTOFA¹, NARGIS AKTER²

¹Breeding Division, Bangladesh Jute Research Institute (BJRI), Manik Mia Avenue, Ministry of Agriculture, Dhaka, Bangladesh.

²Director (Agriculture), Bangladesh Jute Research Institute (BJRI), Manik Mia Avenue, Ministry of Agriculture, Dhaka, Bangladesh.

³Institute of Food and Radiation Biology, Bangladesh Atomic Energy Commission, Ganakbari, Savar, Dhaka, Bangladesh.

ABSTRACT

Mesta (*Hibiscus sabdariffa* L.) commonly known as ‘Roselle or Red Sorrel’ is an annual or biennial plant belonging to the large family *Malvaceae* and is cultivated in tropical and sub-tropical regions for bast fibre, paper pulp or edible calyces, leaves and seed. Its fleshy fruits (Chukur) are used to prepare vegetable, jam, jelly, pickle, tea, etc. due to its attractive colour as well as nutritional values. The self-pollination nature is responsible for narrow genetic diversity of Mesta which can be solved through increasing the genetic diversity by gamma ray mutation. BJRI developed Mesta variety named ‘BJRI Mesta 2’ known as Vegetable Mesta 1 (VM-1) having coppery red stem with branches, finger shaped lobed leaves, fleshy fruits of red or green colour, grey colour seeds with 20% edible oil content, waterlog tolerance, quick growing and higher yield of calyces: 2.0-2.5 t ha⁻¹ and Leaves: 6-7 t ha⁻¹ has been used for chronic gamma irradiation at Gamma Source Unit of Institute of Food and Radiation biology, Bangladesh Atomic Energy Commission, Dhaka, Bangladesh. Delivered irradiation dose has been measured using Fricke and Ceric-cerous dosimetry systems, and the irradiation doses were applied@ 17.10 Gy minute⁻¹ with a dose uniformity ratio (DUR) of 1.13. Mesta seeds (100g) were irradiated with 0.0, 100, 200, 300, 400, 500, 600, 700, 800, 900, 1000, 1100 & 1200 Gy dose, and seeds were planted immediately in research field of BJRI at Manikganj and Dhaka stations. Seed germination percentages were recorded up to five days for each dose. Morphological variations were found in Mesta mutant plants at all accumulated doses of Co⁶⁰ but higher plant height, girth of stem, good plant growth were observed in mutants at the accumulated dose of 100 & 200 Gy than control plants, and 50% plants were died at accumulated dose of 315 Gy which indicates lethal dose (LD₅₀) for Mesta plant. Plants were dwarfed chronologically after 200 Gy treatment. The Roselle mutant plants having distinct variations (in leaves, flower and stem) and good growth than controls were selected and their seeds will be used for further studies. This finding will be useful in determining the most suitable dose rate for chronic gamma irradiation for Mesta plant improvement in future.

Key words: Genetic diversity; LD₅₀; Morphological variability; Physical mutagen; Pollination; Roselle

ROLE OF FEEDING *MORINGA OLIEFERA* DRIED LEAVES IN SMALL RUMINANTS

AHMAD FAHIM^{1*} AND NAZIM ALI²

¹Dept. of LPM; ²Dept of A.H., College of Veterinary and Animal Sciences
Sardar Vallabhbhai Patel University of Agriculture and Technology, Meerut, Uttar Pradesh,
India- 250110

The present review provides information regarding the nutritional importance of feeding moringa (*Moringa oleifera*) in small ruminants. Moringa leaves are enriched with high quality of protein with balanced amino acids profile, bypass protein and good source for essential amino acids especially lysine, essential minerals and vitamins such as vitamin A, B1, B2, B3, C and E that promote animal health and wellbeing. In addition, it contains several bioactive compounds such as tannins, saponins, alkaloids, isophlaphoids etc. which exhibit several beneficial role including antimicrobial, antioxidant and anthelmintic activities. Thus, it can suggest that moringa feeding either alone or as replacement could improve animal health and production. So, it is recommended to plant moringa trees extensively in and around small ruminant production units and studied for further nutritional research aspects.

Keywords: Anthelminthic, Moringa, Small ruminants, Supplementation,

India is mainly an agricultural dominant country, where livestock and agriculture are closely associated with each other. The country has the pride to inhabit nearly 16% of the world livestock population with amazing genetic diversity in spite of mere 2% geographical area on world map. Among all the categories of livestock wealth resources, India has a huge population of small ruminants (sheep and goat) which play an important role in the food security and nutritional health of millions of rural poor people in the category of landless, marginal and small farmers of arid and semiarid rain-fed areas of the country. These small species of ruminants are very well adapted to a variety of agro-ecological conditions and farming situations, although marked variation is seen in their number and density in different states. The economic importance of these species varies between regions, in terms of total output of sheep and goat products, especially the rising demand of mutton and chevron as well as several benefits of sheep and goat milk. The products obtained enjoy a wide acceptability amongst different several cultural groups because there is no taboo against them. The multiplication of goats is so fast with the tropical breeds as they produce twins, triplets and sometimes up to quadruplets, hence, a small flock of goat can quickly expand until it forms major part of the capital asset and a regular source of family income in very less span of time.

The sheep and goat population in our country still sustain to a larger extent on the grazing resources, under extensive and semi-intensive system of management. They offer a great potential in number of aspects due to their relative ease of breeding, care and management, ability to survive on relatively poor quality roughages and forages, hardy nature, adaptation to a wide range of ecological zones and distribution among others. The grazing activity depends on the availability of the grazing resources from pasture and other grazing lands, viz. forest, miscellaneous tree crops and groves, cultivable waste lands and fallow lands. In recent times, sheep and goats production is also becoming popular even in urban and peri-urban communities as a result of the aforementioned merits. Urban livestock production is becoming one of the major food producing activities with growing demand of specific livestock products.

As per the reports of IGFRI (2013), the country suffers an acute shortage of fodder in supply-demand to feed the livestock. In an estimate, the availability of green fodders from cultivated areas and pastures is MT against the demand of 1012.7 MT by 2050. Similarly, in case of dry fodder, estimated total availability will be 547.7 MT (from dry residues and by-products of grain, commercial crops and dry grass from grazing lands and forests) against the requirement of 631.0 MT. The total area under cultivated fodder is only 8.4 m ha on individual crop basis which is static since last two decades. The scope for further increase in area under forages seems meager due to pressure of food crops for human population. Under these circumstances, it is imperative to identify the available alternative feed resources in our local areas which could sustain livestock production without affecting the availability of nutrient supply in animal feeding system. The utilization of fodder trees and shrubs is one potential strategy for increasing the quality and availability of feeds for resource-limited livestock farmers during all seasons. The trees provide a good and cheaper source of protein and micronutrients (Moyo et al., 2012, Sultana et al., 2015). They are more economical to feed the animals rather than the crop residues and poor quality hay that are little in nitrogen, high in lingo-cellulose (Sultana et al., 2015) and poor in vitamin and mineral contents, which leads to low digestibility and reduced voluntary intake (Gerbregiorgis et al., 2012). The intake and digestibility of poor quality roughages could be enhanced by supplementing concentrate diets along with leaf meal (Nurfetaet et al., 2010; Sultana et al., 2015). Moreover, conventional feed resources (grains, cereals, legumes, etc.) for animal production are scarce and highly expensive in many parts of the world (Babeker and Bdalbagi, 2015). This situation has led to consideration of alternative and less-expensive ingredients with adequate protein content and a balanced amino acid profile (Kholif et al., 2016).

In recent years, there has been increased research on alternative protein sources from forage trees and shrubs that can be fed to goat and sheep. Due attention has been given to the use of *Moringa oleifera* leaf meal (MLM) as a protein source and feed component in animal production especially in sheep and goats (Sarwatt et al., 2002 and Asaolu et al., 2010) and also for other ruminants (Sarwatt et al., 2000).

Composition of *Moringa oleifera* leaves

Moringa oleifera is a perennial evergreen tree of variable height, spread in many semi-arid, subtropical and tropical of the world. It can be grown widely with a temperature around 25–35 deg C and sensitive to drought and winds (Gopalakrishnan et al., 2016). It can tolerate a wide range of soil conditions, but prefers a neutral to slightly acidic (pH 6.3 to 7.0), well-drained sandy or loamy soil (Thurber et al., 2010). Under intensive farming conditions, a very high biomass production of moringa leaves over 100 ton of dry matter per ha can be achieved (Foidl et al., 2001). Thus, a large-scale of moringa cultivation has been initiated in many developing countries, including India (Makkar and Becker, 1996).

The fresh moringa leaves revealed the presence of high crude protein (17.01% ± 0.1), carbohydrates (63.11% ± 0.09), crude fibre (7.09% ± 0.11), ash (7.93% ± .12), crude fat (2.11% ± 0.11) and fatty acid (1.69% ± 0.09) (Ogbe et al. 2012). The total ash content showed that it contains essential minerals like calcium, potassium, sodium, iron, manganese and copper. Sultana et al. (2015) reported that moringa leaf meal contains 17.9 to 26.8 % crude protein, with about 47% of bypass protein and enriched with adequate amino acid profile. Moringa is a good source for essential amino acids especially lysine, essential minerals and vitamins such as vitamin A, B1, B2, B3, C and E. The moringa leaves extract also possess sufficient antimicrobial activity resulting in its use as an antimicrobial agent with reasonable safety margins to inhibit bacterial growth in pharmaceutical and food applications.

***Moringa oleifera* leaves as growth inducer**

Several studies conducted to study the effect of feeding moringa leaves to small ruminants showed beneficial effects on animal performance in terms of dry matter intake and animal growth. Sarwatt et al. (2002) studied the effects of substituting sunflower seed-cake with *Moringa oleifera* leaves in goat ration and found that significantly higher dry matter intake was observed at 75 and 100% replacement of moringa leaves. Moyo et al. (2011) conducted an experiment to observe the effect of *Moringa oleifera* leaves on feed intake and growth performance on goats and observed that experimental group receiving additional *Moringa oleifera* dried leaves were reported higher feed intakes than other groups. Fadiyimu et al. (2010) and Gebregiorgis et al. (2012) studied the effect of incorporation of Moringa leaves on feed intake of rams fed experimental diet by replacing the conventional feed stuffs with moringa leaves and recorded significant dry matter intake in all the treatment groups.

Moyo et al. (2011) observed the effect of *Moringa oleifera* leaves on growth performance on goats. The study reported that higher average daily weight gain was observed in group that was offered basal diet with additional Moringa leaves supplementaion followed by other groups in the study. Tona et al. (2014) carried similar experiment to determine the total feed intake, live weight gain and digestibility coefficients of West African dwarf goats fed Moringa oleifera leaf meal (MOLM) at 0%, 5%, 10% and 15% levels. It was reported that the goats fed on the diet containing 15% level of *Moringa oleifera* leaf meal showed significantly improved growth rate than those on lower inclusion levels. Gebregiorgis et al. (2012) studied the effect of feeding dried moringa leaf as supplement to hay on body weight gain of sheep fed experimental diets. The study showed that sheep fedon diet supplemented with moringa leaf gained more weight with increasing level of supplementation. Adegun and Aye (2016) studied the effects of *Moringa oleifera* leaves supplementation on growth performance of experimental rams with replacement to cotton seed cake. Significant difference was observed in body weight gain of rams with higher FCR values in supplemented group.

Antioxidant activity of *Moringa oleifera*

Ruminal microbes are predominantly strictly anaerobes with less developed antioxidant capacity than facultative anaerobic and aerobic microbes (Morsy et al., 2015). Thus antioxidants supplementations in ruminant diets (like mimosine) would lessen oxidative stress, consequently promote more nutrients channeled towards optima microbial growth and a consequence better microbial protein synthesis (Soltan et al., 2017). Moringa leaves are well known to have potent antioxidant activity which could prevent oxidative damage to major biomolecules against free radicals. (Sreelatha and Padma, 2009). Shah et al., 2016 reported moringa leaves to possess natural antioxidant activity due to significantly higher content of ascorbic acid and flavonoids, which enhances its antioxidant acitivity even higher than alpha Tocopherol (Nadeem et al., 2013). El-Desoky et al. (2017) reported high amounts of other compounds with antioxidant activity, like tetra-acetyl-D-xylonic nitrile, phytol and isobenzofuran-1-one 3-aceticacid. The leaves also containing, high amount of quercetin and kaempferol which possess high antioxidant activity, moreover, these two components have been confirmed to decrease cell viability of the human cancer (Saini et al., 2016). Moringa leaf extract enhances the storage stability of butter stored at refrigeration temperature for three months and enhance the oxidative stability of sunflower oil for 90 days at ambient storage temperature with acceptable sensory characteristics (Anwar et al., 2003; Nadeem et al., 2013).

Anthelmintic activity of *Moringa oleifera*

Ruminant production is severely affected by the worm burden in gastrointestinal tract in many developing countries (Mortensen et al., 2003). Majorily, *Haemonchus contortus* is G.I. parasite of concern in goat production as it sucks blood voraciously inside the

abomassum and causes severe anemia, anasarca resulting in acute mortality (Mortensen et al., 2003). Recently, *Moringa oleifera* have been reported to contain ethanolic and aqueous extracts which could potentially kill the *Haemonchus contortus* eggs and infective stage larvae (L3), without likelihood of developing anthelmintic resistance (Hernandez et al. (2021). Similar study using aqueous and ethanolic leaf extracts of moringa also confirmed to suppress activities of *Haemonchus contortus* eggs and other larval stages (L1 and L2) (Tayo et al., 2014). On the whole, *Moringa oleifera* shows high potential in the control of parasites, which could inhibit the spread of related diseases. Moyo et al. (2013) conducted a study to determine the helminth load after supplementing goats with *M. oleifera* leaf and reported that on day 14 the faecal larval count started to decrease significantly in the treatment groups until the end of the experiment. Goats with supplemented diets had lower counts of *Haemonchus contortus*, *Trichostrongylus colubriformis* and *Oesophagastum columbianum* worm burdens. Asaolu et al. (2012) reported supplementation of moringa leaves in naturally infected goat herd may suppress the burden of strongyle worms. These studies describe the potential use of moringa in controlling nematode parasites with over 90% egg hatch inhibition. Tannins have attracted most attention for their effect on internal nematodes in ruminants, not only directly through their antiparasitic activity but might also act indirectly by increasing host resistance (Hoste et al., 2006). Saponins are reported as an excellent source of cytotoxic and anthelmintic constituents that warrant its isolation and purification for new drug development (Ali et al., 2011).

Conclusion

Moringa oleifera are rich source of crude protein and contains several bioactive compounds which has beneficial role in small ruminant production system due to its various mechanism e.g. antimicrobial, antioxidant and anthelmintic activity, thus can be used as one of the promising natural feed resources in ruminant diets. Thus, *Moringa oleifera* plantation needs to be widely promoted in most part of the country where climatic conditions favor its optimum growth.

References

- Adegun M.K. and Aye P.A. (2013) Growth performance and economic analysis of West African Dwarf Rams fed *Moringa oleifera* and cotton seed cake as protein supplements to *Panicum maximum*. *American Journal of Food and Nutrition*, 3(2): 58-63).
- Ali, N., Shah, S.W., Shah, I., Ahmed, G., Ghias, M. and Khan, I. (2011). Cytotoxic and anthelmintic potential of crude saponins isolated from *Achillea Wilhelmsii* C. Koch and *Teucrium Stocksianum* boiss. *BMC Complement Altern Med*. 3, 11- 106.
- Anwar F., Bhangar M.I. (2003). Analytical characterization of *Moringa oleifera* seed oil grown in temperate regions of Pakistan. *J. of Agri. Food Chem*. 51: 6558–6563.
- Asaolu V.O., Odeyinka S.M., Akinbamiyo O.O. and Sodeinde F.G. (2010) Effects of *Moringa* and bamboo leaves on groundnut hay utilization by West African Dwarf goats. *Livestock Research for Rural Development*, 22(1).
- Asaolu V.O., Akinlade J.A., Aderinola O.A., Okewoye A.T and Alalade J.A. (2012). Performance of Grazing West African Dwarf Goats on *Moringa* Multinutrient Block Supplementation. *Asian Journal of Animal Science*, 6(6): 263-277.
- Babekr E.A. and Bdalbagl Y.M.A. (2015). Effect of feeding different levels of *Moringa oleifera* on performance, hematological, biochemical and some chemical parameters of Sudan Nubian goats. *Online Journal of Animal and Feed Research*. 5(2): 50-56.
- El-Desoky, N.I., Hashem, N.M., Elkomy, A. and Abo-elezz, Z.R. (2017). Physiological response and semen quality of rabbit bucks supplemented with *Moringa* leaves ethanolic extract during summer season. *Animal*. 11,1549-1557.

- Fadiyimu A. A., Julias A.A. and Fajesmisin A.N. (2010). Digestibility, nitrogen balance and haematological profile of West African Dwarf sheep fed dietary levels of Moringa oleifera as supplement to Panicum maximum. *J. of Animal Science* 6(10): 634-643.
- Foidl, N.; Makkar H.P.S. and Becker K. (2001). The potential of Moringa oleifera for agricultural and industrial uses. In: Proc. International Workshop What Development Potential for Moringa Products?, Dar-esSalaam, Tanzania, pp. 47.
- Gebregiorgis, F., Negesse, T., and Nurfeta, A. (2012). Feed intake and utilization in sheep fed graded levels of dried Moringa (Moringa stenopetala) leaf as a supplement to Rhodes grass hay. *Tropical Animal Health and Production*, 44(3): 511-517.
- Gopalakrishnan, L., Doriyaa, K., Kumar, D.S. (2016). Moringa oleifera: A review on nutritive importance and its medicinal application. *Food Sci. Human Wellness*. 5, 49–56.
- Hernandez R., Hernández-Rodríguez M., Cruz-Monterrosa R. G., Díaz-Ramírez M., Martínez-García C. G., García-Martínez A. and Rayas-Amor A. A. (2021). Moringa oleifera lam.: A review of environmental and management factors that influence the nutritional content of leaves. *Trop. and Subtrop. Agroecosys.*, 25: 39.
- Hoste, H., Jackson, F., Athanasiadou, S., Thamsborg, S.M., Hoskin, S.O. (2006). The effects of tannin-rich plants on parasitic nematodes in ruminants. *Trends Parasitol*
- Kholif A.E, Moray T.A. Anele U.Y. and Galyean M.L. (2016). Effect of feeding diets with processed Moringa oleifera meal as protein source in lactating Angalo-Nubian goats. *Animal Feed Science and Technology*. 217.45-55.
- Makkar H.P.S and Becker K. (1996). Nutritional value and antinutritional components of whole and ethanol extracted Moringa oleifera leaves. *Animal Feed Science Technology*. 63: 211-228.
- Morsy, A.S., Soltan, Y.A., Sallam, S.M.A., Kreuzer, M., Alencar, S.M. and Abdalla, A.L. (2015). Comparison of the in vitro efficiency of supplementary bee propolis extracts of different origin in enhancing the ruminal degradability of organic matter and mitigating the formation of methane. *Anim. Feed Sci. Technol.* 199: 51–60.
- Mortensen, L.L., Williamson, L.H., Terrill, T.H., Kircher, R.A., Larsen, M. and Kaplan, R.M. (2003). Evaluation of prevalence and clinical implications of anthelmintic resistance in gastrointestinal nematodes in goats. *J. Am. Vet. Med. Assoc.* 200: 495–500.
- Moyo, B., Masika, P. J., Hugo, A., & Muchenje, V. (2011). Nutritional characterization of Moringa (Moringa oleifera Lam.) leaves. *African Journal of Biotechnology*, 10(60), 12925–12933.
- Moyo, B., Masika, P.J., Muchenje, V. (2013). Effects of supplementing cross-bred Xhosa lop eared goats with Moringa oleifera Lam. on helminth load and corresponding body condition score, packed cell volume. *Afr. J. Agric.* 28: 5327–35.
- Moyo B., Patrick J.M. and Muchenje V. (2012). Effect of supplementing crossbred Xhosa lop- eared goat castrates with *Moringa oleifera* leaves on growth performance, carcass and non-carcass characteristics. *Trop. Anim. Health Prod.* 44: 801-809.
- Nadeem, M., Abdullah, M., Hussain, I., Inayat, S., Javid, A. and Zahoor. Y. (2013). Antioxidant Potential of Moringa oleifera Leaf Extract for the Stabilisation of Butter at Refrigeration Temperature. *Czech J. Food Sci.* 31: 332–339.
- Nurfeta, A., 2010. Feed intake, digestibility, nitrogen utilization and body weight change of sheep consuming wheat straw supplemented with local agricultural and agro-industrial by-products. *Tropical Animal Health and Production*, 42: 815–824.
- Saini, R.K., Sivanesan, I., Keum, Y.S. (2016). Phytochemicals of Moringa oleifera: A review of their nutritional, therapeutic and industrial significance. *Biotech.* 6: 203, 1-14.

- Sarwatt, S.V., Kapange, S.S. and Kakengi, A.M.V. (2002). Substituting sunflower seed-cake with *Moringa oleifera* leaves as supplemental goat feed in Tanzania. *Agroforestry Systems* 56(3):241-247.
- Shah, S.K., Jhade, D.N. and Chouksey, R. (2016). *Moringa oleifera* Lam. a study of ethnobotany, nutrients and pharmacological profile. *Res. J. Pharm., Biol. Chem. Sci.*7: 2158–2165.
- Soltan, Y.A., Morsy, A.S., Lucas, R.C. and Abdalla, A.L. (2017). Potential of mimosine of *Leucaena leucocephala* for modulating ruminal nutrient degradability and methanogenesis. *Anim. Feed Sci. Technol.* 223: 30–41.
- Sreelatha, S. and Padma, P.R. (2009). Antioxidant activity and total phenolic content of *Moringa oleifera* leaves in two stages of maturity. *Plant Foods Hum. Nutr.* 64: 303–311.
- Sultana N., Alimon A.R., Huque K.S., Baba M. and Hossain J. (2015). Evaluation of *Moringa* foliage (*Moringa oleifera*) as goat feed. *Iranian Journal of applied animal science.* 5(4): 865-87.
- Tayo, G.M., Poné, J.W., Komtangi, M.C., Yondo, J., Ngangout, A.M. and Mbida, M. (2014). Anthelmintic activity of *Moringa oleifera* leaf extracts evaluated in vitro on four developmental stages of *Haemonchus contortus* from goats. *Am. J. Plant Sci.* 5:1702–10.
- Thurber, M.D., and Fahey, J.W. (2010). Adoption of *Moringa oleifera* to combat undernutrition viewed through the lens of the diffusion of innovations theory. *Ecol. Food Sci. Nutr.* 48: 1–13.
- Tona G.O., Ogunbosoye D.O. and Bakar B.A. (2014). Growth performance and nutrient digestibility of West African dwarf goats fed graded levels of *Moringa oleifera* leaf meal. *International Journal of current microbiology and Applied Science.* 3(8): 99-106.

***Aloe vera* GEL COATING FOR SUPPRESSING RIPENING CHANGES IN ASIAN PEARS**

T. ADHIKARY & PANKAJ DAS

(Agriculture education), College of Horticulture & Forestry, Punjab Agricultural University,
Ludhiana-141001 (India)

Division of Sample survey, ICAR-IASRI, Library Avenue, PUSA, New Delhi, 110012 (India)

Purpose

Asian pears (*Pyrus pyrifolia* L.) are popular among consumers for their unique taste, crispness, fragrance, and proper sugar-acid ratio. Patharnakh is a predominant cultivar of Punjab province (North-western India). The fruit matures at the end of July when both the temperature and relative humidity are comparatively high, limiting transport and storage (Adhikary et al., 2022). Several postharvest technologies have been widely used in the food industry, but all are not safer for consumers. Hence, there is an urgent need for the application of environment-friendly technology such as plant-based edible coatings for maintaining postharvest fruit quality. AVG is a natural hydrocolloid compound composed of polysaccharide compound that forms a semipermeable layer that decreases the respiration and other ripening processes of the fruit thus preserving fruit quality after harvest (Nia et al., 2022). Nevertheless, the potentiality of AVG coating on the maintenance of stored pear quality is yet to be investigated. Therefore, the present study necessitates the application of AVG coating along with optimising the concentration to obtain desirable effects for the preservation of stored pear fruit quality.

Methods

Three groups of fruits were coated with 25%, 50% and 75% AVG respectively by using a soft bristle brush, whereas the control group was kept uncoated. During the experiment, coated and properly dried pear fruits were packed in corrugated fibreboard boxes followed by storage in the cold chamber (0±1 °C & 90-95 % RH). 640 fruits were analysed for physico-chemical and enzymatic study during 30th, 45th, 60 and 70th day of intervals (4 intervals x 4 replication x 4 treatments x 10 fruits for each replication). 6 fruits per replication were kept separately for recording the mass loss during the study, thus total 96 fruit is required. On the first day of storage 40 fruits were analysed for all analysis except for PLW. A total of 776 fruits were required during the study to conduct all physico-chemical and enzymatic studies.

Results

Results showed that AVG 75% coating expanded the storage life of fruit by minimizing mass loss, decay index, respiration rate, polyphenol oxidase activity, softening enzymes activity and maintaining the overall sensory quality (SQ), firmness, soluble solids content (SSC), total phenols, titratable acidity (TA). Based on the findings, the use of natural AVG coating may well be considered suitable to reduce postharvest losses. AVG was also proved to be an alternative to non-edible coatings that extend the marketable span of pear and also cut down the adverse effects of health and environmental hazards.

Conclusions

With the apprehension of health hazards with the use of fungicides, AVG can be considered a safe alternative to control decay in pear fruits. Additionally, it delays the ripening by creating a semi-permeable protective layer thus reducing transpiration as well as respiration which is a major cause of mass loss. The AVG coatings in pear fruits significantly improve the storage life and maintain the quality attributes such as firmness, SSC, TA, TPC and SQ up to 60 days of storage. Significant resistance to fruit softening enzymes and polyphenol oxidase enzymes were observed in coated fruits. AVG coating is available easily in bulk quantity, extraction is easy which can retard postharvest losses. Thus, AVG coating proved to be a convenient, safe and biodegradable coating with improved physical and antimicrobial properties that can be a safer plant-based organic coating option in food packaging industries.

Keywords: Pear, *Aloe vera* gel (AVG), Fruit quality, Enzymatic activities, Storage

Reference:

Adhikary, T., Gill, P.P.S., Jawandha, Kaur, N. (2022). Postharvest quality response of pears with beeswax coatings during long term cold storage. *The Journal of Horticultural Science and Biotechnology*. <https://doi.org/10.1080/14620316.2022.2074321>.

Nia, A. E., Taghipour S., Siahmansour S. (2022). Effects of salicylic acid preharvest and *Aloe vera* gel postharvest treatments on quality maintenance of table grapes during storage. *South African Journal of Botany*, <https://doi.org/10.1016/j.sajb.2022.05.010>

FIELD EVALUATION OF GENOTYPES AGAINST RED ROT, SMUT AND WILT DISEASES OF SUGARCANE

MD. MINNATULLAH*, PRIYA SINGH, SHIVA PUJAN SINGH, AARADHNA AND SANSKRITI SRI, RPCAU, Pusa, Samastipur, Pusa

ABSTRACT

Sugarcane is an important agro-industrial crop of India and it provides employment to over a million people directly or indirectly. It is still one of the visible cash crop in Bihar and state is the traditional sugarcane producer in the country. The existing profitability and long lasting effects of sugarcane are of serious concern and create threat to all those involved in the sugarcane research and expansions. Variety is an important component in enhancing yield of sugarcane. It has been observed that keeping all the components of sugarcane production as constant, if only good quality variety is used for cane production then only one can harvest an increase in productivity up to 20 per cent. The importance of the diseases as constraint in sugarcane production and productivity is well established. It is estimated that losses caused by diseases varied from 10 to 25 per cent. So, evaluation of sugarcane varieties for resistance to diseases is the most useful and profitable means of disease management. In this context evaluation of sugarcane genotypes against major diseases were carried out. In the present study, it was observed that out of 35 evaluated genotypes eight were observed resistant, 16 were moderately resistant and rest genotypes were moderately susceptible to susceptible against red rot disease. The 18 genotypes showed resistant, seven genotypes showed moderately resistant and remaining were found moderately susceptible to smut disease. While, 10 genotypes showed resistant, 14 were moderately resistant and 08 genotypes showed moderately susceptible and remaining three genotypes showed susceptible to wilt disease of sugarcane.

Keywords - Evaluation, sugarcane, genotypes, diseases

COSTS AND BENEFITS OF TWO OIL PALM PLANTATIONS LOCATED IN UGANDA AND MALAYSIA

BONNY KAYONDO, MOHAMADU BOYIE JALLOH, IIMAS ABDUROFI, NUR AAINAA BINTI HASBULLAH, Paramanathan Selliah
Faculty Of Sustainable Agriculture, Universiti, Malaysia Sabah, Locked Bag No.3, 90509, Sandakan, Sabah

Purpose

Oil palm is an adaptable crop grown in diverse tropical environments. However, its optimal productivity is constrained by prevalence of poor soils, weak agronomic practices and environmental constraints common in Africa. Therefore, to increase its productivity and efficiency in such areas requires extra costs to match yields obtained in ideal environments and well-managed commercial plantations found Malaysia. High yields reduce the cost of production, which is a key to compete in a commodity-based market. In this study, we aim to determine the economic feasibility of the two oil palm plantations.

Methods

Cost benefit analyses were used with the Input-Output Ratio measurement. Secondary oil palm fresh fruit bunch and crude palm oil production data from 2016 to 2021 from the two plantations was used. Total revenue, total variable costs and total fixed costs were computed using the CBR formula.

Results

Generally, the average CBR results of 1.07 show that the plantation investment in Uganda is 62% economically more rewarding than the plantation in Malaysia. However, in 2017, the lower CBR of 0.23 for the plantation in Uganda compared to 0.34 for that in Malaysia was because of the low yields caused by drought impact experienced in 2016.

Conclusions

Cost benefit analysis results obtained from plantation in Africa imply that investment in soil fertility and water conservation increases oil palm production and land productivity. Policy makers in the oil palm sector should therefore consider expanding the commercial oil palm industry in Uganda.

Key words: Costs, benefits, oil palm, soils, agronomic practices.

ROLE OF PKV MINI DAL MILL IN RURAL ENTREPRENEURSHIP DEVELOPMENT

N.V. SHENDE, R. D. VAIDKAR, V. K. KHOBARKAR AND D. K. NEMADE
Department of Agricultural Economics and Statistic, PGI, Dr PDKV, Akola, Maharashtra, India

ABSTRACT

Post-harvest processing is one of the necessary steps in conversion, value addition and prevention of loss of agricultural produce. It is essential operation being carried out prior to consumption of agro produce. Most of the post-harvest processing operations are performed at urban side resulting into increased cost of transportation and storage requirement besides loss of some important byproducts and post-harvest losses. Primary or secondary processing of agricultural produce at village level will help to reduce the cost of processed material, giving additional income source to producer, employment generation among the rural youths and in situ value addition. As a result, processed product will be available at lower cost for the rural population also. In view of this the study on economic evaluation and impact assessment of PKV mini da mill was conducted at three district of Vidarbha region viz; Amravati, Akola and Buldhana. The primary as well as secondary data were collected for economic analysis. The cost and returns were estimated on the basis of primary data collected from 30 farmers. The

breakeven point and economic impact were estimated. The study revealed that income of the farmers was increased and migration ceased. It can be installed at a low capital investment of about Rs146461/- only. The variable expenses for running PKV mini dal mill was worked out about Rs 25736.80/- per annum. On an average the quantity of raw material processed accounted to 417 quintals within 150 days, as per raw material available. The processing cost per quintal of PKV mini dal mill were Rs. 450/-.The cost benefit ratio from PKV mini dal mill worked out to 2.81. It revealed that farmer received more than doubled income form PKV mini dal mill after one year of establishment. The breakeven point is 497.81 qtl. As the dal processed in the PKV Mini Dal mill is good in quality, hence 26 per cent farmers state that family member utilized as labour. The inadequate supply of electricity was the major problem faced by the farmers. However, 36 per cent dal mill owner facing the problem of technical knowledge about operating of machinery.It helps to engage the farmers to start subsidiaery enterprise to doubling their income.

Keywords: Cost & Returs, B:C Ratio, Breakeven point

SUBMERGENT RICE VARIETIES: A POTENTIAL OPTION FOR FLOOD PRONE AREA

A.K. TRIPATHI¹, M. THOITHOI DEVI² AND BAGISH KUMAR²

¹ College of Agriculture, Pasighat

² ICAR-ATARI, Zone VI, Guwahati

ABSTRACT

The various dimensions of nature were impacted by climate change. Due to the closeness of agriculture to the climatic parameter, the climate change has affected it drastically. The extreme weather events are likely to increase in the country in general and in the north eastern region in particular resulting into more weather aberrations such as drought and floods. Assam, due to its geographical positioning and presence of Brahmaputra River place itself to the most vulnerable state in the Indian Himalayan Region. As per the estimate in Assam, the climate change accounting more than 40% of land surface susceptible to flood damage. The situation will be more gruesome in future as, over the years the state has been experiencing an increased number of precipitations driven flash floods and long duration floods. The changing climate is also threatening the sustainable production of paddy which is the staple food of the state. Substantial rice growing areas of the state are very low-lying where no other rice except *baodhan* i.e deep-water and floating rice can be grown, which can withstand submergence up to 3-4-meter water depth in low lying areas with water stagnation beyond 50 cm for more than a month in the season. The bao rice varieties are known to rich in mineral contents, but the productivity is low (1.6 to 3 t/ha). Enhancing rice productivity in these areas requires demonstration of suitable varieties that can withstand flash floods and support climate resilient agriculture. Keeping in view the above facts, Krishi Vigyan Kendras under Assam Agricultural University, Jorhat under the guidance of ICAR-ATARI, Guwahati has demonstrated submergence tolerant rice varieties such as *Ranjit sub-1*, *Bahadur sub-1* and *Swarna sub-1* were demonstrated in the farmer’s field according to different agro-ecological situations of Assam under NICRA since 2012. The performances of these varieties and farmers adoption were observed. Weather parameters were recorded based on secondary data and analyzed as per standard procedures. The results indicated that the submergence tolerant rice variety ‘*Swarna sub1*’ can tolerate submergence condition up to 13 days with an average yield of 4.4 t/ha, which was up to 27.93 per cent higher over that of local variety. ‘*Ranjit sub1*’ recorded an average yield of 4.7 t/ha, which is 29.31 per cent higher over local varieties. Another submergence rice variety ‘*Bahadur sub1*’ gave 26.30 per cent increased in yield over local varieties with an average yield of 4.6 t/ha. Farmers could earn more return from adopting these varieties.

**POPULARIZATION OF IMPROVED SHORT DURATION RICE VARIETY
TELANGANA SONA (RNR 15048) THROUGH FRONTLINE DEMONSTRATIONS
IN NALGONDA DISTRICT, TELANGANA**

**SHANKAR, M*¹, AARIFF KHAN, M.A¹, BHARAT, T¹, PALLAVI, S¹, BALAZZI NAAIK,
R.V.T², SUMALINI, K³, RAVINDER NAIK, V³ AND SHANKARIAH, M¹.**

¹Krishi Vigyan Kendra, Kampasagar, PJTSAU, Nalgonda, Telangana-508 207

²AICRP Forage Crops, PJTSAU, Rajendranagar, Hyderabad, Telangana-500030

³College of Agriculture, PJTSAU, Rajendranagar, Hyderabad, Telangana-500030

ABSTRACT

Frontline demonstrations on rice (275 No) were carried out by Krishi Vigyan Kendra, Kampasagar during four *kharif* seasons 2016 to 2019 in Nalgonda District, Southern Telangana Zone under Left Canal Nagarjuna Sagar Project command area with the main objective of assessing the performance of improved short duration rice variety Telangana Sona (RNR 1504) with latest crop production and protection technologies against farmer's practice. The improved practice comprised of improved short duration rice variety RNR 15048, seed treatment, nursery management, recommended cultural practices at the time of transplanting, application of recommended dosage of fertilizers, adopted need based production and protection measures that resulted in significantly higher yield (6790 kg/ha) with 12.0 percent increase yield in demonstration plots over the farmer's practice (6048 kg/ha) during four year study period. The technology gap ranged between 0 to 350 kg/ha with a mean 210 kg/ha. Lowest extension gap (518 kg/ha) observed in *kharif* 2019 and it was the highest (1050 kg/ha) in *kharif* 2018. The average extension gap was 742 kg/ha and the technology index was in the range 0.0 to 5.0% with a mean 3.0%. The demonstrations recorded higher gross return Rs. 1,18,815/ha with a profitability of Rs. 67,190/ha and additional net return Rs. 19,167.0/ha as compared to farmer's practice. The mean benefit-cost ratio was 2.3 in demonstrations over the farmer's practice 1.8. The results based on comparison between demonstrations and farmers practice indicated that the yield, gross returns, net income, and benefit-cost ratio in frontline demonstrations were higher than the local farmer's practice. The Farmers practice recorded lower yields and incurred higher expenditure as farmers used local varieties, applied over dose of fertilizers, and indiscriminate use of pesticides, spending more money on managing the pests and diseases.

Keywords: rice, frontline demonstrations, yield, extension gap, technology gap.

NATURE-BASED SOLUTIONS FOR AGRICULTURAL SUSTAINABILITY, FOOD SECURITY AND CLIMATE RESILIENCE IN NEH REGION, INDIA

SANJAY-SWAMI

(Soil Science and Agricultural Chemistry), School of Natural Resource Management,
College of Post Graduate Studies in Agricultural Sciences, Central Agricultural University,
Umiam (Barapani) - 793 103, Meghalaya, India

ABSTRACT

Nature-based Solutions (NbS) encompasses a variety of practices that, in many cases, have been used for decades, are based on indigenous knowledge or were known under different names like conservation agriculture, climate smart agriculture, etc. Often, the term ‘Nature-based Solutions’ is used as an umbrella concept to cover a range of ecosystem related approaches including ecosystem-based adaptation, natural climate solutions, and green infrastructure. In North Eastern Hill (NEH) region of India, the environment, local conditions, socio-economic and socio-cultural life of different tribal communities and their rituals associated with agricultural practices have given basis for development of many indigenous farming systems, which have in-built Nature-based Solutions for conservation, preservation and utilization of natural resources. The rice-fish system of *Apatani* tribe in Arunachal Pradesh, *ZABO* farming system and *Alder* based farming system in Nagaland, bun cultivation and **bamboo drip irrigation system** in Meghalaya are good examples of location specific Nature-based Solutions in agriculture. My presentation will deal with these important Nature-based Solutions being followed in the NEH region for agricultural sustainability, food security and climate resilience.

Keywords: Nature-based Solutions, NEH region, indigenous knowledge, conservation, natural resources.

RESPONSE OF SOME NEW MAIZE HYBRIDS TO SOME NANO FERTILIZERS UNDER WATER STRESS CONDITIONS.

F.S. ABD EL-SAMIE¹, EKRAM, A. MEGAWER¹ , H.H.M. HUSSEIN², AND SARA, M. MOHAMED¹

1. Agronomy Department, Faculty of Agriculture, Fayoum University, Egypt

2- Agronomy Department, Faculty of Agriculture, Ain Shams University, Egypt

ABSTRACT

Two field trials were conducted during the two successive summer growing seasons of 2019 and 2020, at the Experimental Farm, Faculty of Agriculture, Fayoum University Fayoum Governorate, Egypt. A split-split design with three replicates was used. The main plots were assigned three water stress treatments (skipping of some irrigations) as follows: normal irrigation (7 irrigations) i.e., control treatment, missing the 4th irrigation (64 DAP), and missing the 6th irrigation (78 DAP). The sub-plots were restricted to three yellow single cross hybrids of maize, i.e. single cross hybrid 2055, single cross hybrid 2066 and single cross hybrid 2088, and the sub-sub plots received three concentrations Calcium carbonate nanoparticles i.e. 500 g fed⁻¹, 750 g fed⁻¹ and 100 g fed⁻¹. The results showed that irrigation treatment reflected positive significant influences on growth parameters, normal irrigation resulted in the best mean values of plant height, maximum number of leaves plant⁻¹, largest leaf area plant⁻¹ and heaviest dry weight plant⁻¹ in both seasons 65 and 80 (DAS). Irrigation treatments had a significant effect on number of days from sowing to 50% tasseling in the two growing seasons. The maximum number of days from sowing to 50% tasseling due to irrigation were produced from the normal irrigation compared with the other irrigation treatments {(Withholding the 4th irrigation (64

DAP) and Withholding the 5th irrigation (78 DAP)}. Results showed that yellow single cross hybrids of maize were significantly differed in almost mean values of maize growth, under study in the both seasons. Maize hybrid of S. C. 2088 was significantly surpassed S. C. 2055 and S. C. 2066 in mean values of all growth characters. Calcium carbonate nanoparticles concentrations had a significant effect on growth parameters i. e. plant height, number of leaves/plant-1, dry weight plant-1, and total dry weight of plant in both seasons at 65 and 80 DAS. Data revealed that ear characters i.e. (ear height, ear length, ear diameter, ear weight, number of row/ear, number of grain /row) significantly affected by different irrigation treatments. Normal irrigation produced the highest values. There was significant effect on ear characters i.e. (ear height, ear length, ear diameter, ear weight, number of row/ear, number of grain /row) between different yellow single cross hybrids of maize. S. C. 2088 was significantly surpassed S. C. 2055 and S. C. 2066 in mean values of all ear characters. Application of Calcium carbonate nanoparticles as nano-fertilizers was pioneer and significantly resulted in characters i.e. (ear height, ear length, ear diameter, ear weight, number of row/ear, number of grain /row), high rate of Calcium carbonate nanoparticles produced the highest values.

Key words: Maize, Water stress, Calcium carbonate nanoparticles, yield and its components.

SEED QUALITY ENHANCEMENT THROUGH ORGOPRIMING IN FINGER MILLET (*Eleusine coracana* L.)

V. SRIDEVI*, S. RAGHUL, T. RAMANADANE AND A. KAMATCHI

Pandit Jawaharlal Nehru College of Agriculture and Research Institute, Karaikal,
Pondicherry U.T. -609603

An experiment was conducted in the Seed Technology Research Laboratory, Department of Plant Breeding and Genetics, PAJANCOA&RI, Karaikal during 2019 to study about the influence of seed priming on seed quality characters of finger millet cv. TRY 1. The experiment was carried out using completely randomized design replicated thrice. The treatments comprised of six seed priming agents viz., T₁ - 1% coconut water, T₂ - 3% moringa leaf extract, T₃ - 3% panchakavya, T₄ - 3% arappu butter milk solution, T₅ - 1% cow urine and T₆ - water and T₇ - control (untreated seeds). Among the treatments, priming of seeds with 3% Panchakavya registered significantly superior seed quality parameters viz., germination percentage (94%), speed of germination (49.28), seedling root length (7.40 cm), seedling shoot length (5.14 cm), seedling dry matter (0.0157 g 10 seedlings⁻¹), seedling vigour index I (117.5) and seedling vigour index II (1.47).

Keywords: Finger millet; Seed priming; Seed quality characters

Introduction

Finger millet (*Eleusine coracana*) commonly known as Ragi is extensively grown in various regions of India and Africa. It is the staple food for people under low income levels and during monsoon failure. In India finger millet is cultivated over an area of about 1.19 Mha with a production of about 1.98 Mt of average productivity of 1661 kg ha⁻¹ (Sakamma, 2018). Seed priming is controlled hydration of seeds that restrict the germination but permits pre-germinative physiological and biochemical changes (Khan, 1992). Seed priming helps to improve seed performance with respect to uniformity of germination and rate of germination (DeLespinay *et al.*, 2010). With this background, the present investigation was carried out to investigate the performance of different orgopriming agents in finger millet.

Materials And Methods

An experiment was carried out at the Seed Testing Research Laboratory, Department of Plant Breeding and Genetics, Pandit Jawaharlal Nehru college of Agriculture and Research Institute,

Karaikal during 2019 to study the effect of seed quality enhancement in finger millet cv. TRY1. The experiment was taken up with seven treatments in a completely randomized design replicated thrice. The treatments comprised of six seed priming agents viz., T₁- 1% coconut water, T₂ - 3% moringa leaf extract, T₃- 3% panchakavya, T₄- 3% arappu butter milk solution, T₅-1% cow urine and T₆- water and T₇- control (untreated seeds).

Three gram fresh Moringa leaves were weighed and crushed using pestle and mortar and dissolved in 100 ml of distilled water to make 3% leaf extract. The leaf extract was filtered by using muslin cloth to remove unwanted material and leaf debris. For priming, the seeds were preconditioned by soaking in respective priming agents as per the treatment schedule for three hours and then decanted the extracts and seeds were air dried under the shade to bring back to their original moisture content and used for study purpose.

In the present investigation, the seed quality parameters viz., germination percentage, speed of germination, shoot length, root length, dry matter production, vigour index-1, vigour index-2 were recorded by adopting standard procedures. Petri plate method was adopted for speed of germination and between paper method was followed for all other quality parameters. 50 seeds in petri plate method and 100 seeds in between paper method are used for the study. Speed of germination was observed from the day of germination up to 8th day. And other parameters were recorded on the 8th day. The data were statistically analyzed by adopting statistical methods as outlined by Gomez and Gomez (2010).

Results And Discussion

The responses of the crop were significantly differed due to different priming treatments (Table 1). Among the treatments, the seeds primed with 3% Panchakavya has shown significantly the highest seed quality characters viz., germination percentage (94%), speed of germination (49.28), seedling root length (0.74 cm), seedling shoot length (0.154 cm), seedling dry matter (0.0157 g 10 seedlings⁻¹), seedling vigour index I (117.5) and seedling vigour index II (1.47). The improved seed quality characters on seed priming with 3% panchakavya could be attributed to the presence of macro nutrients, micro nutrients, many vitamins and essential amino acids, growth promoting substances like IAA, GA and beneficial microorganisms (Shubha *et. al.*, 2014).

Conclusion

The study concludes that, all the priming treatments performed better than the control, among the treatments panchakavya 3% as priming agent effectively enhanced the germination and morphological characters in finger millet.

References

- De Lespinay, A., Lequeux, H., Lambillotte, B and Luttus, S. 2010. Protein synthesis is differentially required for germination in *Poa pratensis* and *Trifolium repens* in the absence or in the presence of cadmium. *Pl. Growth Regulator*, **61**: 205-214.
- Gomez, K.A and Gomez, A.A. 2010. Statistical procedures for agricultural research. (2nd Ed.), Wiley India Pvt Ltd., India.
- Khan, A.A., 1992. Pre plant physiological seed conditioning. *Hort. Rev.*, **13**: 131-181.
- Sakamma, S, Umesh, K.B, Girish, M.R., Ravi, S.C., Sathishkumar, M and Bellundagi, V. 2018. Finger millet production system: Status, potential, constraints and implications for improving small farmers welfare. *Journal of Agricultural science*, **10**(1): 162-179.
- Shuba, S., N. Devakumar, Rao, G.G.E and Gowda, S.B. 2014. Effect of seed treatment, panchakavya application and organic farming systems on soil microbial population, growth and yield of maize. In Proceedings of 4th ISOFAR scientific conference ‘Building organic bridges’ at the organic world congress, Turkey. 13-15 Oct., 2014.

Table 1. Influence of orgoprining on germination and morphological characters in finger millet

Treatments	Speed of germination	Germination (%)	Shoot length (cm)	Root length (cm)	DMP (g)	Vigour index I	Vigour index II
T ₁	89.0	48.59	3.69	3.70	0.013	658.0	1.18
T ₂	88.0	48.55	3.84	5.01	0.013	776.0	1.14
T ₃	94.0	49.28	5.14	7.40	0.016	1175.0	1.47
T ₄	88.0	47.26	3.91	7.27	0.014	984.0	1.25
T ₅	90.0	46.30	3.44	3.87	0.015	658.0	1.31
T ₆	85.0	46.25	3.49	5.00	0.013	723.0	1.12
T ₇	81.0	46.68	3.44	3.56	0.013	578.0	1.05
CD (p=0.05)	2.8	1.18	0.28	1.32	0.002	99.8	0.01

T₁- 1% coconut water, T₂ - 1% cow urine, T₃- 3% ,moringa leaf extract, T₄ - 3% panchakavya,

T₅- 3% arappu butter milk solution and T₆- water and T₇- control

CLIMATE CHANGE POLICY FRAMEWORK IN AGRICULTURE AND ITS INTEGRATION NEED IN NEPAL

SHREE BHAGAVAN THAKUR¹ SRISTI KHANAL²

¹ Madhesh Agriculture University, Rajbiraj, Nepal

² Agriculture, Soil Science, Tribhuvan University, Kathmandu, Nepal

Nepal being a party to the United Nations Convention on Climate Change (UNFCCC) and having signed the Paris Agreement, has already chosen its path towards mitigation and adaptation against climate change although Nepal doesn't contribute much to the green-house gases (GHGs) emissions. The priority of the country is adaption to these adverse impacts of climate change, and Nepal National Adaptation Plan is an adaptation response devised by the government that sets out priority programmes in the thematic and cross cutting sectors as outlined in the National Climate Change Policy (2019).

Agriculture contributes about one-third of national GDP and two-third of national employment. Agriculture is highly vulnerable to climate change due to more marginal farmers with small landholding, limited irrigation, low-income, and greater dependency on climate-sensitive natural resources. Climate change has remarkable effects on phenology of plants and breeding behavior of animals impacting production and productivity of agriculture and livestock products, pest and disease infestation, land degradation, soil fertility, animal fertility and behavior, and quality and quantity of food, feed and fodders, biodiversity, gene pool and others. Though many plans, policies and strategies on long term climate change adaptation in various sectors including agriculture and food security have been prepared and implemented, those are inadequate. Policy formulation and integration in development sector concerning to climate change has become an imperative for poverty reduction, livelihood improvement and economic development. The purpose of this study is to provide information and guidance on the integration of the Climate Change Adaptation (CCA) into the government's sectoral strategies, policies and plans as part of the elaboration and implementation of the National Adaptation Plan (NAP) and other climate change adaptation plans, in the changed context where country is divided into 7 provinces and 753 local governments, and is in its establishment stage of structuring and policy formulation in compliance with the national and international

requirements. This study highlights the inadequacy of provincial and local level institutional, financial and technical capacities in formulating and implementing provincial and local sectoral climate change adaptation long term plans with measures to overcome them.

Types Of Literature Reviewed

The national and sub-national legal documents, plans, policies, strategies, programmes and projects were collected from concerned ministries, departments, directorates and authorities and assessed. Scanning and skimming, and positive sorting were done during reviewing. Climate change and environment related important matters were marked and drawn for the study. Current national plans, policies, strategies, acts, regulations and institutional policy documents were also reviewed so as to identify the missing links in earlier build plans and policies and recommending reformulation.

Summary Of Findings

National Climate Change Policy 2019 has been earmarked for the revision of Thematic Working Group (TWG) and Cross-cutting Working Group (CWG), the establishment of Inter-Ministerial Climate Change Coordination Committee (IMCCCC) at the federal level, and Provincial Climate Change Coordination Committee (PC4) at the provincial level to coordinate climate change affairs. However, their roles and responsibilities in uplifting climate change adaptation are still rudimentary. Few ministries have established and/or strengthened institutions and coordination mechanisms to address climate change impacts. The Climate Change Management Division under (Ministry of Forests and Environment (MoFE) is the focal point for the monitoring and reporting of climate change affairs of the country. Nonetheless, the provisions at local and provincial level for climate change adaptation are insufficient.

There exists very new institutional arrangement at the province level for planning, implementing, monitoring and evaluations. Their capacity building is very urgent especially in climate change issues. The policy formulation process is slow in province but, acts, regulations, working guidelines and action plans formulation are taken as priority, however these are not in compliance with the sectoral policies and NCCP 2019. All the provinces’ capacities fall short in formulation and implementation of climate change adaptation policies in different sectors including agriculture. This can be attributed to lack of technical, financial and human resources and lack of coordination among the sectors, lack of harmonization of policies, strategies and plans and delayed decision making and poor foresightedness. Specifically in the agriculture sector, the ADS, 2015 must be revised in compliance with the Nepal's Constitution, the Sustainable Development Goals (2016-2030), the 15th Plan and the National Climate Change Policy 2019. Similarly, the National Agriculture Policy 2004 also needs to be reviewed considering the climate change perspectives.

The institutionalization strategy is required at province level for systematic integration of climate change adaptation. The federal government need to support and facilitate formulation of climate change policies disseminating the climate change-related knowledge, skill and information to provinces. The federal government can mobilize international climate funds on establishing and strengthening provincial institutions. The integration of climate change adaptation measures can be possible through policy integration and mainstreaming by province authority by consideration in preamble, objectives, strategies, working policy, working area, target group, selection criteria and norms, institutional arrangements for planning, implementation, monitoring, accountability, and evaluation tools and mechanisms. The revised Local Adaptation Plan of Action (LAPA) needs to be integrated at municipality and rural municipality level and provinces should support local level to implement them. Local governments need to develop periodic plan, annual and budget focusing on climate change adaptation and implement them. There is a need of capacity building of province institutional structures like PC4, Environment Council, human resources, stakeholders: private and public

sectors for sensitization of climate change issues and integration of climate change adaptation in various existing and new policies, plans, strategies, acts, regulations and working guidelines. A stronger monitoring and evaluation framework needs to be established for integrating CCA into sectoral policies and plans at local and provincial level. MoFE, CCMD as climate change focal point needs to provide technical and institutional support and guide to TWG/ CWG and provincial governments for policy formulation and review of the climate change adaptation policy, strategy, plans, guidelines at sectoral ministry level. The Office of CM and Council of Ministers (OCMCM) at the province and Ministry of Industry, Tourism, Forests and Environment (MoITFE) should be the responsible bodies to communicate the climate change adaptation knowledge and skill to sectoral ministries and local governments. It is also necessary to revise the policies at least in every 10 years, and plans, strategies and guideline at least in every 3 to 5 years as per the need of global, national, provincial and local level. MoFE, CCMD needs to monitor and follow up for mandatory provision of CCA at sectoral policies and plans at province and local level in compliance with National Climate Change Policy 2019.

Conclusion

In the light of changed governance system and national climate adaptation needs, it is important that the capacities of provincial governments along with local level be strengthened for smooth implementation of national plans such as NAP and NDC and other adaptation programs. The sectoral plans and programs also need to be climate responsive for which a thorough review and revision of the existing policies, strategies, plans, acts, regulations, and guidelines is necessary identifying the gaps and needs of climate adaptation in them. Various federal, provincial and local level institutional bodies need to be established, strengthened and capacitated especially for monitoring, evaluation and reporting of climate adaptation affairs. On top of all, the integration of climate change adaptation in sectoral policies and plans of governments need to be regularly monitored, back stopped, supervised and evaluated for quality assurance by the federal government.

References

- Department of Hydrology and Meteorology (DHM). (2017). *Observed Climate Trend Analysis in the Districts and Physiographic Zones of Nepal (1971-2014)*. Kathmandu: DHM, Ministry of Population and Environment, Government of Nepal. http://dhm.gov.np/uploads/climatic/1935165359NAP_TrendReport_DHM_2017.pdf
- Government of Nepal. (2015). *Nepal's Constitution of 2015*. Unofficial translation by Nepal Law society, International IDEA and UNDP. https://www.constituteproject.org/constitution/Nepal_2015.pdf
- Government of Nepal. (2017). *Local Government Operation Act*.
- Government of Nepal. (2019). *National Climate Change Policy, 2076 (2019)*. https://www.mofe.gov.np/downloadfile/climatechange_policy_english_1580984322.pdf
- Government of Nepal. (2020). *The Fifteenth Plan (Fiscal Year 2019/20 – 2023/24)*. Kathmandu: National Planning Commission. https://www.npc.gov.np/images/category/15th_plan_English_Version.pdf
- Government of Nepal. (2020). *Second Nationally Determined Contribution*. Kathmandu: Government of Nepal. [https://www4.unfccc.int/sites/ndcstaging/PublishedDocuments/Nepal%20Second/Second%20Nationally%20Determined%20Contribution%20\(NDC\)%20-%202020.pdf](https://www4.unfccc.int/sites/ndcstaging/PublishedDocuments/Nepal%20Second/Second%20Nationally%20Determined%20Contribution%20(NDC)%20-%202020.pdf)
- Government of Nepal. (2021). *Third National Communication to the United Nations Framework Convention on Climate Change*. Kathmandu: Ministry of Forests and Environment, Nepal. http://mofe.gov.np/downloadfile/Nepal_TNC%20Rep_1627452942.pdf
- Ministry of Agriculture and Livestock Development. (2018). *Policy brief: SDG Localization through Integration of Climate Change in Agricultural Planning and Budgeting at the*

- National and Sub-national Levels*. Kathmandu: MoALD, Government of Nepal.
https://www.np.undp.org/content/nepal/en/home/library/crisis_prevention_and_recovery/policy-brief-sdg-localization-through-integration-of-climate-change-in-agricultural-planning-and-budgeting.html
- Nepal Constitution. 2015, Government of Nepal. Available at Nepal Law commission.
<http://www.lawcommission.gov.np/>
- United Nations. (1992). *United Nations Framework Convention on Climate Change*.
https://unfccc.int/files/essential_background/background_publications_htmlpdf/application/pdf/conveng.pdf
- UNFCCC. (2015). *Paris Agreement*. As contained in the report of the Conference of the Parties on its twenty-first session, FCCC/CP/2015/10/Add.1.
http://unfccc.int/files/home/application/pdf/paris_agreement.pdf
- SDG. 2015. UNDP. *UN summit 2015 September*. Sustainable Development Goals (SDG). 2015-2030.

INFORMATION COMMUNICATION TECHNOLOGY – A WAY FORWARD FOR TRANSFER OF TECHNOLOGY OF AGRICULTURE

**RAJESHWARI N, PRAVEEN R SHINDHE, SUREKHA SANKANAGOUDAR, RAGINI
MODI AND SPOORTHI K N**

Department of Extension and Communication Management, College of Community Science, UAS,
Dharwad.-580005.

ABSTRACT

Agriculture continues to be the most important sector of Indian Economy. Research, extension and farmers efforts have all contributed significantly to increase in food production. Agricultural extension in India has evolved through different phases from Community Development Programme in 1952 through Training and Visit system in 1970's & the recent Agricultural Technology Management Agency (ATMA) which emphasizes on involvement of all stakeholders in the production process. But seeing into the constraints of Human resource changing technologies & reforms in IT sector. IT enabled extension services is slowly gaining importance in wake of the Telecom revolution in order to speed up the delivery of the agricultural advisory services. The initiatives have come from the Central Government, State Government, Corporate sector, NGO's & Private Agencies. According of Telephone Regulatory Authority of India (2017), there are 431.21million internet users in India & slowly the rural sector is catching up from 48 million users in 2012 to 371 million mobile internet users at present. e-Sagu' which was implemented in 2004-05 aimed to develop a model for providing personalized agricultural advice to farmers for major crops such as paddy, cotton, maize, chilli, castor, red gram, ground-nut. An Information and Communication Technology (ICT) based extension model called 'e-Velanmai' (means e-agriculture) for dissemination of farm specific agricultural technologies from the agricultural scientists to the needed farmers was initiated in the selected command areas of Tamil Nadu state. e- Sap has been successfully built & tested and deployed by UAS, Raichur in association with Tene agriculture solution pvt.ltd, Bangalore. e- SAP is novel ICT platform and dedicated field device capable of making two way exchange of information in real time. ICT system dedicated for crop health management. Insect pests, microbial diseases, nutritional deficiencies and weed problems. It enumerates different species of natural enemies, which has gained importance during recent times. There is provision to capture the history of plant protection measures that have previously been adopted by the farmer while raising the current crop.

Keywords: e- Sagu, e- Velanmai and e- SAP

Introduction

Agriculture continues to be the most important sector of Indian Economy. Research, extension and farmers efforts have all contributed significantly to increase in food production. Agricultural extension in India has evolved through different phases from Community Development Programme in 1952 through Training and Visit system in 1970's & the recent Agricultural Technology Management Agency (ATMA) which emphasizes on involvement of all stakeholders in the production process. But seeing into the constraints of Human resource changing technologies & reforms in IT sector. IT enabled extension services is slowly gaining importance in wake of the Telecom revolution in order to speed up the delivery of the agricultural advisory services. The initiatives have come from the Central Government, State Government, Corporate sector, NGO's & Private Agencies. According of Telephone Regulatory Authority of India (2017), there are 431.21million internet users in India & slowly the rural sector is catching up from 48 million users in 2012 to 371 million mobile internet users at present. e-Sagu' which was implemented in 2004-05 aimed to develop a model for providing personalized agricultural advice to farmers for major crops such as paddy, cotton, maize, chilli, castor, red gram, ground-nut. An Information and Communication Technology (ICT) based extension model called 'e-Velanmai' (means e-agriculture) for dissemination of farm specific agricultural technologies from the agricultural scientists to the needed farmers was initiated in the selected command areas of Tamil Nadu state. e- Sap has been successfully built & tested and deployed by UAS, Raichur in association with Tene agriculture solution pvt.ltd, Bangalore. e- SAP is novel ICT platform and dedicated field device capable of making two way exchange of information in real time. ICT system dedicated for crop health management. Insect pests, microbial diseases, nutritional deficiencies and weed problems. It enumerates different species of natural enemies, which has gained importance during recent times. There is provision to capture the history of plant protection measures that have previously been adopted by the farmer while raising the current crop.

ICT Infrastructure Scenario

Internet penetration rate in India from 2007 to 2021

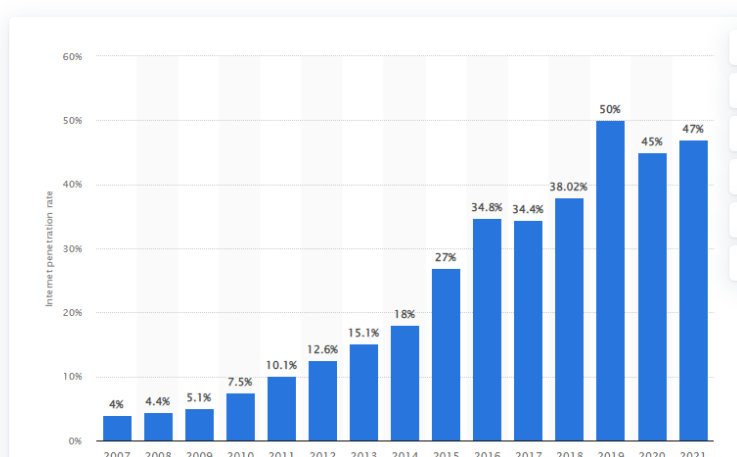

IT and Farming



Source: FAO, ITU

ICT based Agricultural Services

1. e Sagu - Personalized agricultural advisory framework

Intermediaters / Knowledge Workers : e- SAGU

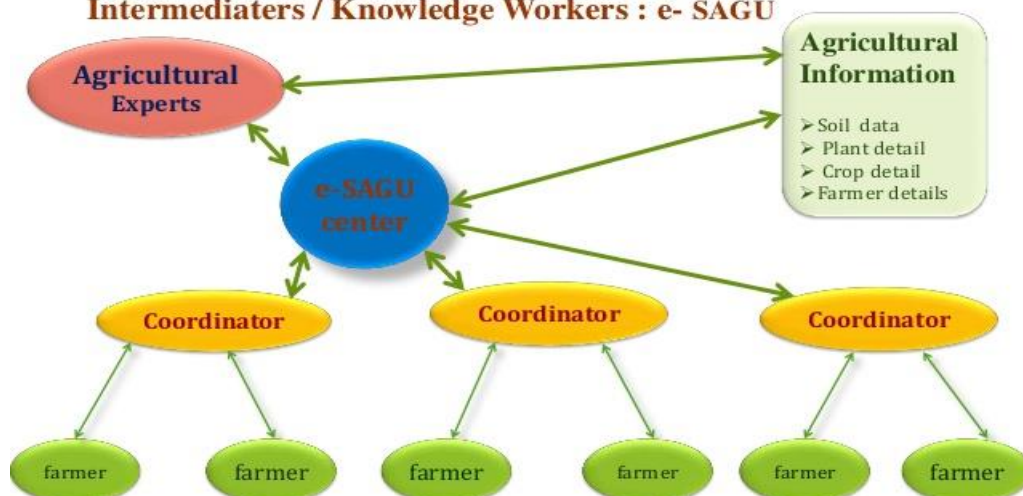

e-Sagu’ which was implemented in 2004-05 aimed to develop a model for providing personalized agricultural advice to farmers for major crops such as paddy, cotton, maize, chilli, castor, red gram, ground-nut. The project covered about 5000 farmers in more than 30 villages in Andhra Pradesh. Value added services viz. making available appropriate pesticides and fertilizers, credit facilities, storage and marketing etc. were also integrated. The advice was provided on a regular basis (once a week) from sowing to harvesting. One e Sagu local center covered a group of about ten villages. Educated and experienced farmers worked as coordinators. depending on the crop, each coordinator was assigned a fixed number of farmers. He collects the details of the farms including soil data, water resources. Every day the coordinator visited a fixed number of farms and took 4-5 photographs for each farm, prepared a CD and transported to the main system by courier. Agricultural

experts at the e Sagu main lab analyzed the crop situation with respect to soil, weather and other agronomic practices and prepare a farm specific advice

Experience of e Sagu

- The cross-section comparison of project area with that of non-project area shows better access to information, knowledge score, and higher rate of adoption of modern practices in project area.
- Farmers have realized quantitative benefit flows in the form of saving in fertilizers, pesticides and enhanced yield.
- The gain due to e Sagu is about Rs.3820 per acre and cost benefit ratio for the project as the whole is 1:3. e Sagu was more acceptable to the farmers as 78 percent responded it as more useful and have expressed their willingness to pay a part of the expenditure of the project

2. e- Velanmai An ICT enabled e extension model (2007)

An Information and Communication Technology (ICT) based extension model called ‘e-Velanmai’ (means e-agriculture) for dissemination of farm specific agricultural technologies from the agricultural scientists to the needed farmers was initiated in the selected command areas of Tamil Nadu state. This model was subjected to pilot testing and validation to standardize the technology transfer process for achieving maximum effectiveness in solving the farm problems leading to enhanced returns to farmers from agriculture. The pilot experiment was done during July 2007 to March 2011 in three sub basins viz., Palar, Varaghanadhi and Aliyar of Tamil Nadu with the support of the World bank aided TNIAMWARM project of the Government of Tamil Nadu. Based on the successful results obtained in the performance of the model, World Bank has supported for up scaling the e-Velanmai model of extension in 19 irrigation project command areas of the state during 2011-12 and in 26 sub basins during 2012-13. ‘e-Velanmai’ project was evaluated periodically and recommended by World Bank experts for implementation as a technology transfer model during 2015-16 in 100 blocks of Tamil Nadu through the extension officials (BTM/ATM) of the Department of Agriculture.

Concept of e-Velanmai

It is a combination of personal and ICT based, demand driven, participatory and sustainable extension approach to provide appropriate and timely agro advisory services by scientists to the registered farmers using ICT tools (Internet, Tablet, Mobile Phone etc.) on need and/or regular basis with necessary follow up actions attempted by Field Extension Coordinators (Karthikeyan, 2012).

Achievements by the Project

- A total of 1436 farmers joined the scheme, most of them (85.37%) were small and marginal farmers with <5acre holding .A membership fee of INR 1,11,100 was deposited in bank in the name of the WUA account.
- About 2300 scientific advices were offered to the farmers to solve both problem and decision based queries.
- 2279 items of technical advice were offered to the farmers to solve their farming problems in various areas of agriculture under the e-agriculture mode of technology transfer.
- About 203 farmers had sent the photos directly to the scientists either by themselves or through their children and the rest through FC. About 2093 advices (91.84%) were delivered on the same day in which the query was raised (Karthikeyan, 2012) (Prabha et al ,2016)

3. e SAP (Electronic Solutions against Agricultural Pests)

e- Sap has been successfully built & tested and deployed by UAS, Raichur in association with Tene agriculture solution pvt.ltd, Bangalore. e- SAP is novel ICT platform and dedicated field device capable of making two way exchange of information in real time. ICT system dedicated for crop health management. Insect pests, microbial diseases, nutritional deficiencies and weed problems. It enumerates different species of natural enemies, which has gained importance during recent times. There is provision to capture the history of plant protection measures that have previously been adopted by the farmer while raising the current crop. If a new pest management strategy has to be disseminated to many field workers spread across a vast geography, a press of a button in some remote location would ensure instantaneous delivery to all of them. The platform can disseminate information built in various forms like videos, animations, images, text and audio.

On the other hand, if a pest attack is noted in a cotton field in Raichur district, the managers/ researchers will know it, and will be able to view the field in real-time in their respective offices/ laboratories anywhere in the world. Spatial coordinates of the field are instantaneously reflected on a GIS map along with the extent of severity of the problem such data are presented in automatically updated graphs and tables that enable real-time monitoring of field situations. In built intelligence aids the process of decision-making, so that biases are minimised and decisions are based on authentic, verifiable field data. Concurrently, this system will ensure seamless integration of different players in the agricultural. e- SAP was run on a pilot basis in Raichur district in Karnataka covering 4,000 farmers and about 10,000 hectares in 5 taluks. The technology is not very costly. The cost of a single tablet is Rs 25,000, which can come down if it is produced on a mass scale.

Achievements

- Large scale deployment e-SAP has reached over 1,00,000 farmers covering 26 crops in all 6 districts of Karnataka.
- Rural Employment More than 50 extension workers recruited under various projects have received employment opportunities.
- Effective use of pesticides The opportunities for selling ineffective (and sometimes, spurious) substances has drastically come down.
- The quantity of pesticides applied has also been according to the prescription, which has reduced indiscriminate usage of pesticides.
- Scientific pest management e-SAP has helped farmers overcome a major difficulty - reliable identification of their crop pest problems.
- Further, e-SAP has effectively driven the concept of quantification of the pest problem and has introduced the concept of pest-intensity based management system.
- Farmers receiving printed prescriptions carry it to the retailers and demand the same to be given to them.
- It has had a significant impact on the interactions between the pesticide retailers and farmers. Their confidence levels for tackling pest problems have increased. This is largely because of the fact that they are completely involved in the identification and quantification (rkvy.nic.in)

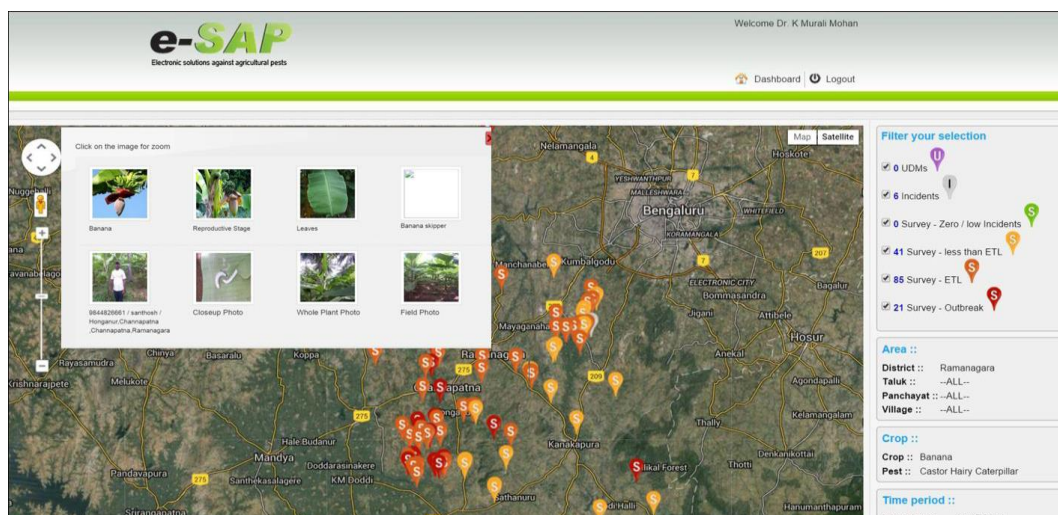

4. digitalGREEN -Participatory Video for Agricultural Education

A project was initiated by Mellinda Gates foundation and Green Foundation an NGO. Content was provided by local farmers with the guidance of experts Videos are created and screened thrice in a week during evening hours One year trial was taken up involving 1,470 households in Karnataka. Digital Green has demonstrated that a participatory process of engagement combined with simple technology solutions can enable small-scale farming communities to produce and share information on best practices for improved productivity and sustainable livelihoods. Initial pilot studies not only indicated a higher uptake of practices through the video-based approach, but also revealed that the Digital Green model was more cost-effective than classical systems of agricultural extension. Gandhi et al. (2008) state that the Digital Green approach was at least ten times more efficient seven times more likely to encourage farmers to adopt new practices compared to conventional agricultural extension systems

Challenges of Information Communication Based Extension Services

1.Pilot Project Syndrome: Most of the ICT based Agricultural extension projects were implemented as Pilot project and after the pilot period most of the projects are never implemented in larger scale. Efforts for continuance of pilot projects are not taken sincerely by the implementing and also finding (Donor) agencies

2.Users Unwilling to Pay: Most of the Agricultural extension projects beneficiary (generally) farmers) are not willing to pay for the service they receive. Similar to most developing countries farmers, in India also most farmers feel that agricultural advisory services are welfare activity of the State and National Governments. And hence, they are unwilling to pay for the services.

3.Small Scale of Operation: The ICTs for agricultural extension projects were implemented in very limited geographical area and covering few hundred or at maximum thousands of farmers. Exceptionally few projects like farmers call centers and e-Soil Health Card Programme covers entire country and Gujarat state, respectively. And few web portals are developed for larger farm stakeholders (AGMARKNET, InDG, e-Krishi). However continuous updating and maintain web portals require sufficient resources, which are lacking after few years

4.Islands Of Learning: In almost all the projects the participation of agricultural education, and research institutions appears to marginal. Most of the projects do not have collaboration with other farm research and extension stakeholders. Practical challenges or constraints in implementing the ICT projects are seldom disclosed and shared with others. Learning experience of one project to another project is seldom shared.

5. Lack of Systematic Evaluation: Most of the projects never revealed actual evaluation result Generally they report Positive results, and most common difficulties such as inadequate rural ICT infrastructure (especially frequent power cuts) and difficulty in content localization and customization were indicated. Systematic and objective evaluation or impact of the projects was seldom done. Similar type of projects with little modification was implemented in isolated manner. Except few projects, large number of projects evaluation results were never published or communicated.

6. Knowledge Middle Men with Less Permanency: Most published projects are from educational/ research institutions, which generally ignored traditionally extension system and extension personnel, those who are serving over a long period in rural India. They implemented time bound ICT projects and hired facilitators/ intermediaries. Once projects completes stated objectives and targets. Facilitators also disappear along with the project. In this regard, Digital green used the services of the public extension personnel. Even, if project winds up the learning took place among extension personnel will be remain for a longer time and more useful to the farmers. In e-Arik case public extension personnel are unwilling to collaborate with the ICT project, because of most of the field level extension personnel never used internet and lack of skill in using other ICTs. However Subject Matter Specialists from Farm Science Centre (KVK) was willingly collaborated with the e-Ark project.

(Balaji et al, 2007)

Strategies and Policy Options

1. National and State Government e – Agriculture Policy: National and state e – Agriculture policy need to be formulated. It should explore and outline the possibilities of leveraging ICT for Agricultural Extension.
2. Human Resource Development: Creating awareness on ICT potentials, ICT using skill and capacity development among the extension personnel of the public and private extension systems and also among farmers and other stakeholders in the extension systems.
3. Strengthening ICT infrastructure : Extension organizations need to be equipped with ICTs
4. Localisation and Customization of Content : Research, educational institutions and extension systems should continuously strive for the appropriate content localization and customization as per the demand of the farmers and other stakeholders
5. Convergence of Communication methods: For effective agricultural extension service delivery, the convergence of traditional extension communication methods (personal contact methods, print media, radio and TV) and new ICTs are to be appropriately used to reach farm stake holders.

Reference

Anonymous, 2000, Policy framework for agricultural extension (draft), Extension division, DoA & C, Ministry of Agriculture, Government of India, New Delhi.

Balaji, V., Meera, S.N., and Dixit, Sreenath ., 2007, ICT enabled knowledge sharing in support of extension : addressing the agrarian challenges of developing world threatened by climate change, with a case study from India, *SAT eJournal, eJournal.icrisat.org*, 4(1): 8-10

Gandhi, Rikin., Veeraraghavan, Rajesh., Toyama, Kentaro and Ramaprasad, Vanaja., 2008, Digital Green: Participatory video for agricultural extension, *14d Magazine*, June, pp. 4-6.

Gandhi, Rikin., 2015, Digital Green: Leveraging social networks for agricultural extension. In: *Success Stories on Information and Communication Technologies for Agriculture and Rural Development*. (Ed. Sylvester, G), RAP Publication, Bangkok, pp. 3-17.

Ganesan, M., Karthikeyan, Kavitha., Prashant, Suma and Umadikar, Jayalakshmi., 2013, Use of

- mobile multimedia agricultural advisory systems by Indian farmers: Results of a survey, *J. Agric. Ext. Rural Dev.*,5(4): 80-89.
- Karthikeyan, C., 2012, “e- Velanmai” – An ICT enabled Agricultural Extension Model, *Int. J. Exten.Edu.*,8 : 24-30
- Prabha, D., Theodore, Ravikumar., Aduthurai. and Karthikeyan, C., 2016, Extension Approach e – Velanmai Model of Extension Service. Paper presented In: *Int. Con. – Innovative Digital Application for Sustainable Development*, Univ. Agric. Sci., Bangalore, January 5-7, p. 678
- Rao, Venkateshwar B., Sudarshan Reddy, A and Krishna Reddy, P., 2012, Impact analysis and experience of e-sagu implementation for cotton crop, *Agro-Informatics and Precision Agriculture* 5(1): 235-256.
- Saravanan, R., 2010, *ICT's for Agricultural Extension*, New India Publishing Agency, New Delhi, India
- www.aiaee.org/attachment/222-Sulaiman - Vol-10.1-3pdf
- [www.afcindia.org.in/PDF/research reports/ATMA](http://www.afcindia.org.in/PDF/research%20reports/ATMA)
- www.ftp.fao.org/docrep/fao/008/a0219e00.pdf
- [www.mmp.cips.org.in/ workshop/2015](http://www.mmp.cips.org.in/workshop/2015)
- www.traai.in

APPLICATION OF *PARABURKHOLDERIA* AND *DELFTIA* TO MITIGATE CADMIUM TOXICITY IN RAPESEED

MD. RAKIB HOSSAIN RAIHAN, MIRA RAHMAN AND MIRZA HASANUZZAMAN*

Department of Agronomy, Sher-e-Bangla Agricultural University, Dhaka-1207, Bangladesh

Purpose:

Cadmium (Cd) altered physiological processes of plants by creating obstacles in carbon fixation and photosynthetic pigment synthesis, and lead to excessive generation of reactive oxygen species (ROS) by interrupting the electron transport chain, antioxidant defense, and nutrient metabolism. We investigated the role of two different rhizobacteria in conferring Cd tolerance through improving ROS scavenging, antioxidant defense, and glyoxalase system.

Methods

Soil, as well as seeds of rapeseed (*Brassica campestris* cv. BARI Sarisha-14) were treated with *Paraburkholderia fungorum* BRRh-4 (ca. 1×10^9 CFU ml⁻¹) and *Delftia* sp. BTL-M2 (ca. 5×10^8 CFU ml⁻¹). Fourteen-day-old seedlings were exposed to 0.25 and 0.5 mM cadmium chloride (CdCl₂) for two weeks. After growing for another 14 days in the Cd-supplemented conditions, growth, physiological, and biochemical parameters were recorded and the experiment was followed by a completely randomized design (CRD) with three replications.

Results

Cadmium-treated plants resulted in a higher accumulation of hydrogen peroxide, increased lipid peroxidation, electrolyte leakage, chlorophyll damage, and impaired antioxidant defense and glyoxalase systems. Consequently, it reduced plant growth and biomass production, and yield parameters. However, endophytes-inoculated plants significantly ameliorated the Cd toxicity by enhancing the activities of antioxidant enzymes (ascorbate peroxidase, dehydroascorbate reductase, monodehydroascorbate reductase, glutathione reductase, glutathione peroxidase, and catalase) and glyoxalase enzymes (glyoxalase I and glyoxalase II) which led to the mitigation of oxidative damage indicated by reduced hydrogen peroxide, lipid

peroxidation, and electrolyte leakage that ultimately improved growth, physiology, and yield of the bacterial inoculants rapeseed plants.

Conclusions

The results of the present study indicate a potential role of the rhizobacterium, *Paraburkholderia* and *Delftia* in mitigating Cd-induced damages in rapeseed plants.

Keywords

Abiotic stress; Methylglyoxal; Oilseed crop; Plant-microbe interaction; ROS; Soil heavy metals

MITIGATION OF SALT STRESS IN SOYBEAN BY THE APPLICATION OF *Bacillus subtilis*

MIRZA HASANUZZAMAN^{1*}, MD. RAKIB HOSSAIN RAIHAN¹, FARZANA NOWROZ¹ AND MASAYUKI FUJITA²

¹Department of Agronomy, Sher-e-Bangla Agricultural University, Dhaka-1207, Bangladesh

²Faculty of Agriculture, Kagawa University, Miki-cho, Kita-gin, Kagawa, Japan

Purpose:

Plant growth promoting rhizobacteria plays a crucial role in augmenting plant growth through modulating direct and indirect regulatory mechanisms under salinity. Considering the growth-promoting potential and other regulatory roles of bacteria, a pot experiment was conducted to investigate the possible mechanism of *Bacillus subtilis* in conferring salt tolerance in soybean.

Methods

Soybean (*Glycine max* cv. BARI Soybean-5) seeds were inoculated with *B. subtilis* (ca. 1×10^8 CFU ml⁻¹), either through presoaking with seeds or direct application with pot soil. After 20 days of sowing, both seed- and soil-inoculated plants were exposed to 50, 100, and 150 mM NaCl for 30 days. The experiment was carried out in a completely randomized design with three replications.

Results

A clear sign of oxidative stress was evident through a remarkable increase in lipid peroxidation, hydrogen peroxide, methylglyoxal, and electrolyte leakage in the salt-treated plants. Disruption of enzymatic and non-enzymatic antioxidant enzymes leads to an imbalance in redox homeostasis in the salt-affected plants. Consequently, plant growth, biomass accumulation, water relations, and synthesis of photosynthetic pigments were decreased. Salt stress also caused an increased Na⁺/K⁺ ratio and decreased Ca²⁺. On the contrary, *B. subtilis* inoculated plants showed increased levels of ascorbate and glutathione and their redox balance as well as the activities of antioxidant enzymes viz., ascorbate peroxidase, monodehydroascorbate reductase, dehydroascorbate reductase, glutathione reductase, superoxide dismutase, catalase, glutathione peroxidase, glutathione S-transferase, and peroxidase. Inoculation of *B. subtilis* also enhanced the activities of glyoxalase enzymes in plants, which mitigated methylglyoxal toxicity in coordination with ROS homeostasis. Besides this, the accumulation of K⁺ and Ca²⁺ was increased to maintain the ion homeostasis in the *B. subtilis* inoculated plants under salinity. Furthermore, plant water status was uplifted in the salt-treated soybean plants with *B. subtilis* inoculation. Thus, inoculation of *B. subtilis* enhanced the growth and biomass production as well as photosynthetic pigments, of the salt-affected soybean plants.

Conclusions

The investigation reveals the potential of *B. subtilis* in mitigating salt-induced oxidative stress in soybean plants through modulating the antioxidant defense and glyoxalase system along with the maintenance of ion homeostasis and osmotic adjustments.

Keywords: Plant growth promoting rhizobacteria, Salinity, Soybean, Ionic toxicity, Osmotic stress, Oxidative damages, Antioxidant defense

AN ECONOMIC ANALYSIS OF VEGETABLE PRODUCTION IN RAICHUR DISTRICT OF KARNATAKA

AMRUTHA T. JOSHI, SATISHKUMAR M. SIDRAMAYYA AND MANJUNATH DODAMANI

Department of Agricultural Economics, College of Agriculture, UAS, Raichur

Purpose : The present study aims to know the scenario of vegetables, workout the cost and returns and marketing of selected vegetables in Raichur district of Karnataka state.

Methods : The study was carried out purposively during 2021-22 in Raichur district of Kalyan Karnataka region where the vegetables production is on the rise. A total of 30 vegetable growers were selected for the study using snow ball random sampling technique. To fulfil the objective of the study, primary data were collected through personal interview method using pre-tested schedules. The collected data were tabulated and analysed by employing descriptive statistics. The procedure and method of costing of various inputs and that of outputs were included in the study.

Results : The study highlighted that the sample farmers cultivated a number of crops on their farm. Tomato, okra and brinjal were the major vegetables, while redgram, cotton, paddy were the major field crops. The returns per rupee invested in vegetable production was highest in case of okra (1.31) and this was followed by brinjal (1.30) and tomato (1.23) which indicated that okra crop earned better returns over other vegetable crops considered (1.31). There was a single channel of marketing notices in the study area for vegetables.

Conclusions: It is concluded that okra crop is more economical than tomato and brinjal which creates a pathway for continues profitability as well as sustainability of agriculture.

Keywords : Vegetables, Production scenario, Cost and returns

INFLUENCE OF NOZZLE TYPE AND SPRAY VOLUME ON BISPYRIBAKE SODIUM EFFICACY IN PADDY WEED ECOSYSTEM

JEETENDRA KUMAR^{1*}, WAJID HASAN¹, SHOBHA RANI ¹ AND R.K. SOHANE²

¹ Krishi Vigyan Kendra, Jehanabad, BAU, Sabour (Bihar)-804432, India,

²Director Extension Education, BAU, Sabour, Bhagalpur-813210, Bihar, India

Farmers generally use chemical method of weed control in cultivation of crops, due to ease and effectiveness in weed management. Herbicides are generally applied by low pressure sprayers. Spray nozzle is a very important part of sprayer which is essential to obtain the proper size of droplets that is also responsible for effective application of herbicides. Effective spray can be achieved by suitable nozzle type, its spray tip, nozzle boom, sprayer operating pressure, sprayer calibration (Chethan *et al.*, 2019) along with proper spray volume. Raj and Syriac (2016) used flat fan nozzle for effective application of bispyribake sodium + metamifop 14 % SE for weed control in wet seeded rice. Keeping this in view, the present study was carried out at farmers' field in Jehanabad, Bihar for assessment of nozzle type and spray volume on bispyribake sodium efficacy in paddy weed ecosystem.

Methodology

An on farm trial was conducted at farmer's field in Jehanabad district of Bihar (India) during Kharif season 2018 and 2019 for assessment of influence of nozzle type and spray volume on bispyribake sodium efficacy in paddy weed ecosystem. Jehanabad district is situated at 25° to 25° 15' North Latitude, 84° 30' to 85° 15' East Longitude and at an altitude of 54 meter from mean sea level. It is located in the southern part of Bihar that lies in NARP Zone– III B with sub- humid, sub-tropical agro ecological system. The soil of the experimental area is level

having a good tilth. The district's topography is alluvial plain and the soil is old alluvial which varies from loam to clay. Maximum and minimum temperature of the district is 47°C in summer month (June) and 5°C in winter month (January) whereas maximum and minimum relative humidity is 99 percent and 26.66 percent, respectively. Mean annual rainfall of the district is 1074 mm out of which most of the rain occurs during *Kharif* season i.e. in the months of June to October.

Farmers of the district generally used very less volume of water with cone type nozzle resulting weedicide not reaches to the target in proper amount. The field trial was conducted with 6 and 7 replications in two consecutive years having three technological options i.e. TO-1: Spraying of recommended dose of bispyribake sodium with cone type nozzle with Knapsack sprayer using spray volume of 200 l/ha (Farmers Practice), TO-2: Spraying of recommended dose of bispyribake sodium with flat fan nozzle with Knapsack sprayer using spray volume of 400 l/ha and TO-3: Spraying of recommended dose of bispyribake sodium with food jet nozzle with Knapsack sprayer using spray volume of 600 l/ha. Paddy var. Sahabhagi and R. Sweta grown with seed rate 10 kg/ha with recommended agronomical practices. Yield data, weed mass as well as economics of use of different nozzles were recorded and analysis of the study was done.

Results

Results of the study has been mentioned in Table-1 which indicated that during Kharif 2018, highest yield of paddy (41.8 q/ha) along with B: C ratio 2.25 and 52.08 percent less weed incidence was observed in plots of TO-2 (Spraying of recommended dose of bispyribake sodium with flat fan nozzle with Knapsack sprayer using spray volume of 400 l/ha) followed by TO-3 plots (Spraying of recommended dose of bispyribake sodium with food jet nozzle with Knapsack sprayer using spray volume of 600 l/ha) with 41.2 q/ha yield, B: C ratio of 2.21 and 41.66 percent reduced weed incidence as compared to 40.5 q/ha yield with B: C ratio 2.18 in Farmer's practice plot (TO-1).

Table 1: Effect of nozzle type and spray volume on bispyribake sodium efficacy in Paddy crop

Technology option	Weed weight (gm/sq. m)		Yield (q/ha)		BC ratio	
	I st Yr.	II nd Yr.	I st Yr.	II nd Yr.	I st Yr.	II nd Yr.
TO-1	48	54	40.5	40.6	2.18	2.23
TO-2	23	12	41.8	43.4	2.25	2.39
TO-3	28	15	41.2	43.0	2.21	2.36

During Kharif 2019, maximum yield of paddy (43.4 q/ha) with B: C ratio 2.39 and 77.7 percent less weed incidence was recorded in plots of TO-2 followed by TO-3 plots with 43.0 q/ha yield along with B: C ratio 2.36 and 72.2 percent reduced weed incidence as compared to 40.6 q/ha yield with B:C ratio 2.23 in Farmer's practice plot (TO-1).

Conclusion

The present investigation reveals, the superiority of flat fan nozzle for spraying of recommended dose of bispyribake sodium with Knapsack sprayer using spray volume of 400 l/ha for weed control in paddy. Among different type of nozzle, its use recorded highest grain yield of 41.8 q/ha and 43.4 q/ha along with highest B: C ratio of 2.25 and 2.39 in two respective years of experiment. Thus, considering the economics and weed control efficacy, flat fan nozzle can be recommended for application of bispyribake sodium for weed control in paddy.

References

- Chethan, C.R., Singh P.K., Dubey R.P., Subhash Chander and Dibakar Ghosh. 2019. Herbicide application methodologies: influence of nozzle selection, droplet size and spray drift on effective spraying – a review. *Innovative Farming*, 4(1): 45-53.
- Raj, S.K. and Syriac, E. 2016. A new herbicide mixture: bispyribake sodium +metamifop 14 % SE for weed control in wet seeded rice. *Res. in crops*, 17 (3): 421-427.

CONSERVATION AGRICULTURE: A NEW PARADIGM FOR IMPROVING SYSTEM PRODUCTIVITY AND RESOURCE USE EFFICIENCY IN DIVERSIFIED CROPPING SYSTEM

T. PANDIARAJ, PRAKASH YADAV AND D.K. SINGH

College of Agriculture (ANDUA&T., Kumarganj, Ayodhya), Kotwa, Azamgarh-276001, (U.P.), India

Rice-wheat is the major cropping system, about 85% of arable area, in the Indo-Gangetic Plains (IGP) of India. Extensively adapted conventional tillage (CT) is endangering the sustainability of this system in the IGP mostly due to increasing production costs, increased pest and disease resurgence, weed incidence, labour scarcity and extreme climatic events. Frequent tillage extends the turnaround period, delays wheat sowing by 10–15 days and consequently results in yield decline by coinciding wheat grain filling period with hot dry air after 15th February. With such adverse effects of CT, conservation agriculture (CA) could be an alternative option in these regions with a diversified cropping system that involves less water, labour and energy and simultaneously increase system productivity and use efficiency of resources. The agronomic and economic potential indicators of the CA practices vary according to the location with soil and climatic conditions, crop management practices and technical know-how of the farmers. These indicators have been studied with different CA practices in the rice-wheat system in IGP (Devkota *et al.*, 2020). However, a systematic study of CA in diversified cropping systems to evaluate their potential to improve the total system productivity and resource use efficiency in the IGP is lacking. Hence, this study aimed to compare different rice-based cropping systems for system productivity and use efficiency of production and land in IGP.

METHODOLOGY

The study was conducted from 2011 to 2013 at a site on the Norman E. Borlaug crop research center, G.B. Pant University of Agriculture and Technology, Pantnagar, (29°N latitude 79.3°E longitude and 243.8 m AMSL) in Uttarakhand state, India. Twenty-four treatments were carried out with three replicates each consisting of two types of tillage i.e. RT (DSR/ZT/RT) and CT (conventional tillage) with and without paddy straw mulch in the main plot and two levels of fertility (100 and 75% RDF) in sub plot. The eight combinations resulting from these treatments were sown as three different cropping systems i.e., existed cropping system of rice-wheat (CS1), rice-vegetable pea-greengram (CS2) and rice-potato-maize (CS3) along with fertility levels in sub plot. The experimental design was a factorial split-plot design. All the agronomical management practices were followed according to crops.

Each plot was harvested mechanically to determine economic yield at maturity; total system productivity is usually calculated by summation of rice equivalent yield in a specified cropping system. Cropping system productivity was calculated by dividing the total system productivity by the duration of crop and relative production efficiency was determined by total system yield under diversified improved RCT cropping system multiplied by total system yield under the existing system and divided by the system yield under the existing system and it is expressed in percentage.

RESULTS

1. Total System Productivity (TSP)

The TSP of RT and CT were 201.7 and 185.2 q ha⁻¹ in 2011-12 and 205.3 and 185.3 q ha⁻¹ in 2012-13 years, respectively (Table 1). The TSP of CT was decreased by 8.2 and 9.7 percent compared to those of RT during both years, respectively. TSP of the mulched plot was significantly higher than that of no-mulched plot during both years, which was increased by 20.7 and 24.6 percent when compared with that of no-mulch during 2011-12 and 2012-13, respectively.

The TSP of CS₃ was significantly increased by 30.7 and 54.6 percent higher in 2011-12 and 25.5 and 56.8 percent higher in 2012-13 years over CS₂ and CS₁, respectively. Fertilizers with 100% RDF application had 10.5 and 10.6 percent greater than that of 75% RDF application in both years, respectively.

2. CROPPING SYSTEM PRODUCTIVITY (CSP)

Productivity of total cropping sequence in a unit of kg ha⁻¹ day⁻¹ has been presented in Table 1. The study showed a restricted number of tillage systems in RT significantly increased the total productivity of cropping system in both years. Statistical analysis and planned means comparison of the data revealed that RT resulted in an 8.99 and 11.07 percent increase during both the years over CT treatments.

The comparison of data resulted that the application of paddy straw mulch to soil resulted in a 20.8 and 24.9 percent increase during both years compared with the no-mulch treatment.

The corresponding increase in productivity of cropping system was 89.1 and 92.1 kg ha⁻¹ day⁻¹ in rice-potato-maize followed by 76.8 and 81.5 kg ha⁻¹ day⁻¹ in rice-veg. pea-greengram system during both the years, respectively. The CS₃ recorded 33.5 and 48.8 percent higher CSP than CS₁ and 16.1 and 13.0 percent higher than CS₂ during both years, respectively. Application of 100% RDF produced 10.4 and 10.6 percent more productivity during 2011-12 and 2012-13, respectively compared with 75% RDF.

3. RELATIVE PRODUCTION EFFICIENCY (RPE) AND LAND USE EFFICIENCY (LUE)

The RPE in RT was higher at about 105.6 and 104.0 percent and 96.6 and 91.7 percent in CT system during 2011-12 and 2012-13, respectively and the increase was to the tune of 9 percent. In the case of mulch, straw mulch gave significantly higher RPE and outperformed no-mulch treatment with increased RPE of 35.0 and 45.4 percent higher over no-mulch plot. Different cropping systems had a significant influence on RPE of the system. In general, a diversified cropping system performed more outstandingly than an existing traditional rice-wheat system. The cropping system of rice-potato-maize (CS₃) produced significantly higher RPE followed by rice-veg. pea-greengram (CS₂) system. Among the cropping system, CS₃ outperformed 19.8 and 39.6 times higher than CS₁ and 1.59 and 1.48 times higher than CS₂ during 2011-12 and 2012-13, respectively. Among the fertility levels, fertilizer 100% RDF application produced significantly higher RPE of the total system as compared to 75% RDF application.

The LUE of the system varied among the different cropping systems. The diversified cropping system of rice-potato-maize (CS₃) occupied a greater number of days than other systems in the treatment. The LUE of CS₃ was 82.7 and 79.7% during both years, respectively followed by the following rice-wheat (CS₁) system.

CONCLUSION

From the study, it appears that a holistic approach to RCT practices might a possible route toward sustainable agricultural production in rice-based systems. The combination of different RCT practices such as mulching, and direct seeding/ zero tillage in a diversified cropping system resulted not only benefit in enhancing system productivity and soil health but also in mitigating climate change and successfully could be adopted against vulnerable and extreme climatic conditions. Therefore, these holistic approaches to RCT practices are technically sound, agronomically efficient, economically attractive, practically feasible and environmentally safe.

REFERENCES

Devkota, K.P., Yadav, S., Khanda, C.M., Beebout, S.J., Mohapatra, B.K., Singleton, G.R., Pushkur, R., 2020. Assessing alternative crop establishment methods with a sustainability lens in rice production systems of Eastern India. *J. Clean Prod.* 244, 118835.

Table 1 Total system productivity (q ha⁻¹), cropping system productivity (kg ha⁻¹ day⁻¹), relative production efficiency (%) and land use efficiency (%) of rice-based cropping system as influenced by different conservation agricultural practices in 2011-12 and 2012-13

Treatments	TSP		CSP		RPE		LUE	
	2011-12	2012-13	2011-12	2012-13	2011-12	2012-13	2011-12	2012-13
Tillage system (T)								
Reduced tillage (RT)	201.7	205.3	70.9	73.9	105.6	104.0	77.3	76.3
Conventional tillage (CT)	185.2	185.3	65.1	66.5	96.9	91.7	77.3	76.3
SEm.±	0.62	0.65	0.22	0.24	0.64	0.73	-	-
LSD (P=0.05)	1.76	1.87	0.62	0.69	1.83	2.08	-	-
Mulch (M)								
No- mulch	175.3	173.9	61.6	62.4	85.7	79.2	77.3	76.3
Straw mulch	211.6	216.6	74.4	77.9	115.7	115.3	77.3	76.3
SEm.±	0.62	0.65	0.22	0.24	0.64	0.73	-	-
LSD (P=0.05)	1.76	1.87	0.62	0.69	1.83	2.08	-	-
Cropping system (CS)								
Rice-wheat	105.7	104.3	38.1	37.0	8.8	4.20	75.9	77.3
Rice-Veg. pea-Greengram	205.7	213.5	76.8	81.5	109.7	112.2	73.4	71.8
Rice-Potato-Maize	269.1	267.9	89.1	92.1	174.3	166.3	82.7	79.7
SEm.±	0.76	0.80	0.27	0.30	0.79	0.90	-	-
LSD (P=0.05)	2.16	2.29	0.76	1.12	2.24	2.55	-	-
Fertilizer levels (F)								
100% RDF	203.1	205.1	71.4	73.7	110.9	107.3	72.5	71.5
75% RDF	183.9	185.5	64.6	66.7	82.6	79.9	72.5	71.5
SEm.±	0.62	0.65	0.22	0.24	0.64	0.73	-	-
LSD (P=0.05)	1.76	1.87	0.62	0.69	1.83	2.08	-	-

NATURAL FARMING: A VIABLE TOOL FOR SUSTAINABLE FUTURE AGRICULTURE TOWARDS A HEALTHY NATION

PRAKASH YADAV, T. PANDIARAJ, D.K. SINGH AND VIMLESH KUMAR

College of Agriculture (ANDUAT, Kumargaj, Ayodhya), Kotwa, Azamgarh -276001 (U.P.), India

ABSTRACT

Modern agricultural practices have a major impact on the environment. Excessive use of fertilisers such as urea, nitrate, phosphorous along with many other pesticides has affected air, water, and soil quality. Using chemicals leads to more pest attacks on crops for which farmers rely on pesticides. In addition, because of soil damage more and more chemicals and pesticides need to be used. High-yielding varieties of seeds, chemical fertilizers, assured irrigation and pesticides were key components of this high-input technology. However, the rise in food production has come at a price in the form of groundwater depletion, land degradation, yield stagnation, loss of agri-biodiversity and the long-term impact on farmers' and consumers' health. It is now time to move from resource-intensive to sustainable agriculture. The Budget 2022-23 and Prime Minister Narendra Modi's recent call to take agriculture out of chemical laboratories and connect it with nature's laboratory reaffirms this realization.

In India, a chemical-free and climate-resilient method of farming was given by scientist Subhash Palekar, in 2006 in Maharashtra to end the problems arising after the Green Revolution by introducing natural farming. His methods were popularized when farmers started adopting his methods. After that, many researchers and scientists claimed that natural farming is a good alternative to chemical farming that directly or indirectly impacts sustainable development positively. The aim of natural farming is to reduce the cost of production to almost zero and to come back to the “pre-Green Revolution” style of agriculture. This would seem to lead growers out of loans by putting a stop to agricultural chemicals practices. The most critical aspect of natural farming is to let nature play a dominant role to the maximum extent possible. Hence, no-till, farm biodiversity, integration and symbiotic farm components and protection of soil cover all have a place in this process of farming.

What is Natural farming?

Natural farming involves chemical-free farming and livestock-based farming methods. It is a diversified farming system that integrates crops, trees and livestock, allowing the optimum use of functional biodiversity. Natural farming works on the principle that there is no shortage of nutrients in soil, air and water, and healthy soil biology can unlock these nutrients. Natural farming, though in its preliminary stages, is showing increased positive results and is being adopted by farmers in good faith. It is even cited by farmers that labor and production costs have drastically reduced by 14–45%.

Components of Natural Farming

1. Jeevamrutha

Jeevamrutha is the first and most important pillar of zero-budget natural farming (ZBNF). It is a blend of aged cow urine and fresh cow dung from India’s indigenous jaggery, water, pulse flour, soil, and cow breed. This mixture is one type of natural fertilizer applied to farmland.

2. Bijamrita

Bijamrita is the second component of ZBNF. It is a blend of tobacco, green chilies and neem leaf pulp, used for insects and pest control. It’s used to treat seeds, and it provides natural protection to seeds.

3. Acchadana (Mulching)

Acchadana (Mulching) is the third pillar of zero-budget farming. It helps to maintain soil moisture content. This pillar helps to protect the cover of soil cultivation and does not ruin it by tilling.

4. Whapasa

Whapasa is a condition where water molecules and air molecules are present in the soil. It helps to reduce the extra irrigation requirement.

Advantage

Improve Yield- Natural Farming aims to increase yields by maximizing production factors like labour, soil, equipment and by avoiding the use of non-natural inputs like fertilizers, herbicides and pesticides in several cases, higher yields per harvest were also reported.

Increase Farmer’s income- Natural Farming aims to make farming viable and aspirational by increasing the net incomes of farmers on account of cost reduction, reduced risks, similar yields, incomes from intercropping

Minimize the cost of production- Natural Farming aims to drastically cut down production costs by encouraging farmers to prepare essential biological inputs using on-farm, natural and home-grown resources.

Ensure better health- As Natural Farming does not use any synthetic chemicals, health risks and hazards are eliminated. The food has higher nutrition density and therefore offers better health benefits

Employment generation- Natural farming generates employment on account of natural farming input enterprises, value addition, marketing in local areas, etc. The surplus from natural farming is invested in the village itself

Environmental conservation- Natural Farming ensures better soil biology, improved agrobiodiversity and more judicious usage of water with much smaller carbon and nitrogen footprints.

Livestock sustainability- The integration of livestock in the farming system plays an important role in Natural farming and helps in restoring the ecosystem. Ecofriendly bio-inputs, such as Jivamrit and Beejamrit, are prepared from cow dung and urine, and other natural products.

Helps in combating climate change: Natural farming not just creates cost savings for farmers, but also ensures higher carbon fixation into the soil, which can mitigate climate change.

References

- Palekar (2005). The Philosophy of Spiritual Farming Amravati: Zero Budget Natural Farming Research, Development and Extension Movement. Amravati.
- Tripathi, S., and Tauseef, S. (2018). Zero Budget Natural Farming, for the Sustainable Development Goals. Andhra Pradesh.

INNOVATIVE VEGETABLE PRODUCTION IN UTTARAKHAND HILLS

ANITA SINGH,

School of Agriculture, Graphic Era Hill University, Dehradun

Introduction:

In the state, farmers adopt generally two types of agricultural practices i.e. the rainfed and the irrigated. Most of the agriculture in the state is rainfed. The total geographical area of the state is 5.35 mha, out of which 4.6 m ha (86%) is hilly area and 0.74 m ha (14%) is plain area. The State is having about 61.1% area under forests.

The net irrigated area to net sown area for the state is 45 percent. Being large area under hills, irrigation is available mostly in the plains and valleys. Major crops grown in the Uttarakhand are **Rice, Wheat, Sugarcane, Maize, Soybean, Pulses, oilseeds and a number of fruits and vegetables**. Uttarakhand has four agro-climatic zones covering six altitudinal farming approaches, which means there is potential to grow a wide variety of crops within the State. Besides the threats there are ample opportunities of increasing production and productivity, especially in the field horticulture, agro processing industries, off season vegetable cultivation, Vertical Garden and cultivation of medicinal and aromatic plants which can be gainfully exploited. There is also a good opportunity of organic farming, diversification of agriculture, post-harvest technologies, strengthening of market interventions, and use of farm machinery to make the agriculture more profitable occupation.

Constraint of Hill Agriculture

- ❖ Small, fragmented and scattered land holdings
- ❖ Sloppy topography leading to soil erosion and runoff.
- ❖ Shallow and rocky soils that are subject to periodic water stress.
- ❖ Crop land scarcity and water scarcity
- ❖ Lack of basic marketing infrastructure and transportation facilities
- ❖ Increased migration from hills to plain
- ❖ Natural hazards like strong storms, hailstorms, floods, epidemic diseases, pests and irregular monsoons

Scope for improvement in hills

- ✓ To motivate for advance and innovative technologies in Horticulture sector

- ✓ Beekeeping, a traditional practice in the mountain, is commercially exploited to its full potential.
- ✓ Precision agriculture(remote sensing, GIS)
- ✓ Emphasis on promoting agro-processing industry, ensuring value addition and reducing post-harvest losses.
- ✓ Cold chain infrastructure(produce and planting materials)
- ✓ Agricultural credit at reasonable rates and risk insurance for crops and farmers.
- ✓ Ensuring better market prices.

Off-season vegetable cultivation

Off season vegetable cultivation refers to the production of fresh vegetables outside of their typical cropping cycle, i.e. when supply is low and prices are high. The main advantage of off-season vegetables is to ensure food security during the scarce period to promote seasonal employment and to ensure high price for farmers

This hilly state is bestowed with congenial agro-climatic conditions and has enormous potential for the production of off-season vegetables like, Tomato, coloured Capsicum, green peas, beans, cabbage, cauliflower, summer squash, Baby corn, Broccoli, Beet root and Cucumber, which are successfully grown in the season when these are not available in plains. The returns of off-season vegetable cultivation are very high as compared to traditional cereal crops.

Technologies for Uttarakhand Hills

In temperate or in subtropical region during winter season, the main constraints of vegetable production is low temperature and lack of irrigation facilities.

- **Low tunnel**
- **Trench technology**
- **Walk-in tunnel/ Plastic tunnel**
- **Polyhouse**
- **Vegetable grafting**
- **Kitchen waste to compost**
- **Nutritional Gardening(Micro green)**
- **Planting of cucurbitaceous vegetables in retaining walls**

Low tunnel

It is the easiest and cheapest method of controlling environment by using polythene sheets. About 1m wide raised beds are prepared and bamboo stakes are bent over it to make a semi-circular shape and polythene sheets are put over it. This is generally practiced for raising seedlings for summer crops during the winter months. Low tunnel structure fig 1.



Fig1: Low Tunnel

Walk-in tunnel

A walk-in tunnel is an un-heated, covered cultivation area and the structures are large enough to walk in and work inside. Walk in Tunnels are basically the protected structure made from Pre-galvanized pipe and covered with UV Stabilized Plastic Sheet. Generally Walk-in Tunnels

are used to give favorable controlled environment like temperature, humidity, light intensity, ventilation, soil media, disease control, irrigation, Fertigation and other agronomical practices throughout the season irrespective of the natural conditions outside. (Fig 2) Walk In Tunnel have variety of applications, the majority being, growing of vegetables, floriculture, planting material acclimatization, fruit crop growing for export market.

Advantage of Walk -in Tunnel

- Trellising system for vegetable.
- Reduction in labour cost.
- Less chances of disease attack, thus reduction in disease control cost.
- Less fertilizer requirement, thus reduction in fertilizer cost.
- Uniform and better quality
- Cost of the structure is less than other protected structure.

Dimension

- ❑ **Width: 2-2.5m**
- ❑ **Length: upto 30m**

Growing Crop under Walk in Tunnel: Walk-in tunnel is used to produce or to cultivate the short growing vegetable crops.

Vegetables:- Cucumber, color Capsicum, Cherry Tomato, Broccoli, Lettuce, Strawberry, Chives etc.



Fig 2: Growing of Cucumber walk –In tunnel

Table 1: Yield characteristics averaged over 3 years for vegetables using high and low tunnel

Crop	Time from transplanting until 50% ripening	Marketable yield (kg m ⁻¹ of row)	Mature (%)	Fruit weight (kg)
Muskmelon				
High tunnel	87	17.8	90	1.34
Low tunnel	101	7.2	40	0.97
Tomato				
High tunnel	99	12.7	53	0.14
Low tunnel	107	6.6	33	0.14
Pepper				
High Tunnel	–	10.9	70	0.12
Low Tunnel	–	4.5	7	0.13

Waterner, 2003

Trench Technology

Trench is a simple structure for growing vegetables during extreme winters. Trench cultivation harnesses soil and solar heat to create suitable climatic conditions for growth of leafy vegetables like spinach, fenugreek, coriander, rai etc.



Fig 3: Trench Technology in Leh Ladakh

Low-cost polyhouse

Low-cost polyhouse was **constructed using locally available bamboo and metallic wire for developing the frame**. UV stabilized film of 200 μ (800 gauge) was used for covering the roof and 75% shade net on the side walls. The estimated cost of construction of a 100 m² size polyhouse varied between Rs. 13000 to 15000. **Performance of different vegetables under low cost polyhouse(Table 2, Singh and Kalia,2005)**

Crops grown in Polyhouse

- Fruits that can be grown are Papaya, Strawberry etc.
- Vegetables that can be grown include Bitter Gourd, Capsicum, Cauliflower, Tomato etc.
- Flowers like Carnation, Gerbera, Marigold, Orchid and Rose can also be easily grown.

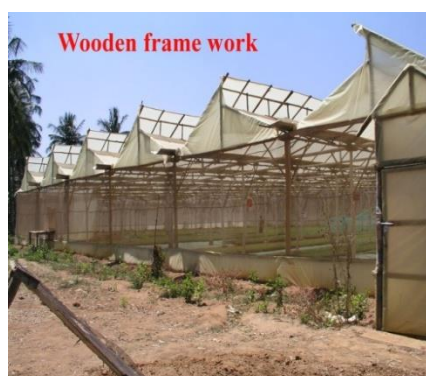

Fig 4: Protected cultivation of Tomato under low cost polyhouse

Table 2: Performance of different vegetables under low cost polyhouse

Crops	Time of Planting	Spacing (cm)	Polyhouse yield (t/ha)	Outside yield(t/ha)	Protected increase over control
Capsicum	Mid Nov.	50×30	78.4	21.4	267.8
Tomato	Mid Nov.	100×45	84.0	26.3	221.7
Okra	Mid Feb.	40×15	21.8	12.1	80.2
Broccoli	Mid Sept.	50×50	22.1	16.1	37.3

Shade net House

A Shade house is **a structure enclosed by agro nets or any other woven material to allow required sunlight, moisture and air to pass through the gaps**. It creates an appropriate micro climate conducive to the plant growth. It is also referred as shade net house or net house. Shade net cost per acre ₹ 14, 00,000. As we all know, sunlight is so crucial to a plants' growth, so choose the right density and as low a density as you can get away with. Usually a shade

percentage of **30-50% is ideal for vegetables**. Most vegetables do well **under 30% shade cloth**, especially tomatoes, eggplants and capsicums and other heat tolerant vegetables. Darker leaf vegetables, such as chard and spinach and sensitive vegetables like lettuce, do well under 60% shade cloth. Flowers are often grown under 60% as well. Yield of European Cucumber in net-house is 25 t /ac(Fig 6)



Fig 5: Net house cultivation of coloured Capsicum

Performance evaluation of capsicum in open field and under covered condition



Fig 6: European Cucumber in net-house

Grafting of Vegetables to improve Production

This technique was introduced into Europe and other countries in the late 20th century along with improved grafting methods suitable for commercial production and productivity of grafted vegetable seedlings. Vegetable grafting involves cutting the stem of a vegetable plant at the seedling stage and attaching it to the rootstock of the seedling of a vegetable plant like wild brinjal or pumpkin. Once the attachment is made, the grafted seedling is grown in controlled climatic conditions, after which it can be planted in the field. Grafting onto specific rootstocks generally provides resistance to biotic and abiotic stress tolerance, growth, yield and quality of crops, soil borne diseases and nematodes. Grafting is an effective technology for use in combination with more sustainable crop production practices, including reduced rates and overall use of soil fumigants in many other countries. The first interspecific, herbaceous grafting was recorded in 1920 for watermelon (*Citrullus lanatus*) in Japan. Vegetable grafting research at ICRISAT is focused on tomato and Chilli plants but is also being tested upon capsicum, brinjal, bitter gourd, snake gourd, and even the exotic vegetable zucchini.

More than 400 vegetable producers in India's Andhra Pradesh state have taken to cultivating grafted vegetables in an attempt to double their incomes through increased yields. Farmers are reporting around 30-50% increase in yields from use of grafted varieties over traditional varieties.



Grafted plants

Procedure of vegetable Grafting

- Diagnosis
- Rootstock Selection
- Seedling / Transplant Production
- **Grafting Technique**
- Healing Chamber Management
- Returning to Life on the Farm

Types of Grafting

- ❑ Inter-generic grafting
 - ❖ Watermelon/ Bottle gourd
 - ❖ Cucumber/ Pumpkin
 - ❖ Melon/ Wax gourd
- ❑ intra-specific grafting
 - ❖ Eggplant: *Solanum melongena*
 - ❖ Scarlet egg plant : *Solanum integrifolium*
 - ❖ *Solanum torvum*.

Methods of Vegetable Grafting

- **Hole insert grafting (HIG).**
- **One-Cotyledon Grafting Method**
- **Tongue approach grafting (TAG).**
- **Splice grafting.**
- **Cleft grafting.**
- **Tube grafting.**
- **Slant cut grafting.**

Cucurbits: Melon, Cucumber, etc.

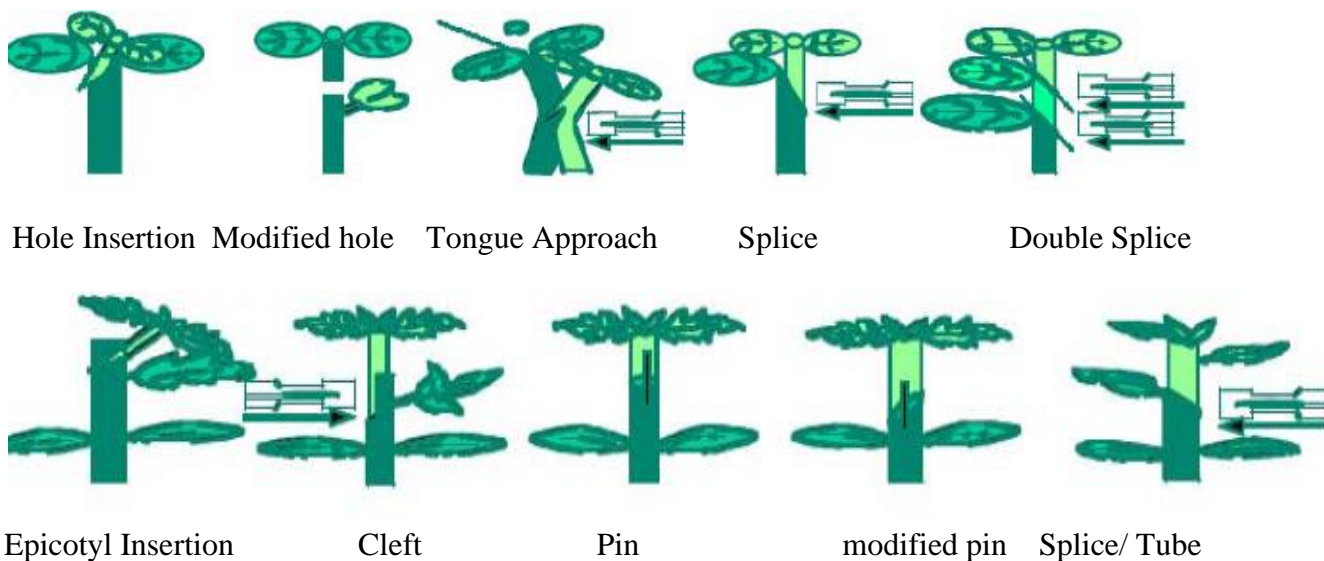

Fig 7: number of different methods for grafting vegetable crops

A list of grafting tools

- Rootstocks
- Scions
- Razor blades



Clips



Grafting wax



Grafting Secateurs



Grafting rubber



A healing chamber

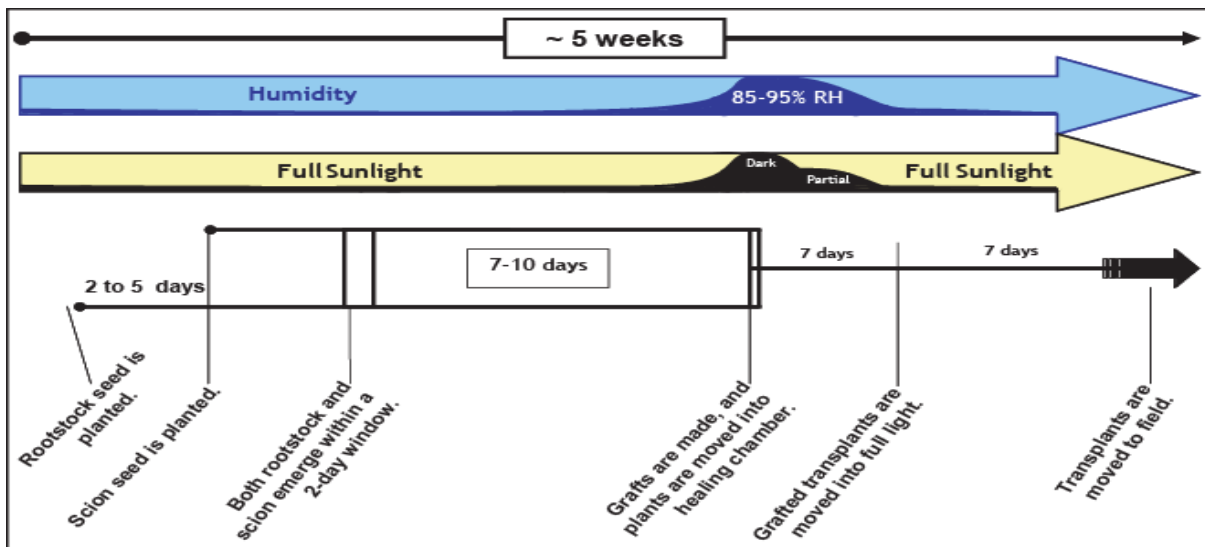

Fig 8 Grafting Timeline



Fig 9, Grafting robot

Table 3. Rootstock and method of grafting in different vegetable crops

S.no.	Vegetables	rootstock	Methods of grafting
1.	Watermelon	Squash & bottle gourd	Cleft & tongue approach grafting
2.	Cucumber	Squash & fig leaf gourd	Splice & tongue approach grafting
3.	Tomato	wild species of tomato	Splice and tongue approach grafting
4.	Brinjal	Brinjal and wild species	do
5.	Capsicum	Pepper & wild relative	Splice grafting
6.			

Microgreen: Healthy substitute

What Are Microgreens?

Microgreens are **young vegetable greens that are approximately 1–3 inches (2.5–7.5 cm) tall**. They have an aromatic flavor and concentrated nutrient content and come in a variety of colors and textures . Microgreens are considered baby plants, falling somewhere between a sprout and baby green



Fig 10, Microgreen

Arugula

Arugula microgreens have a peppery flavor that make them great for salads, eggs and sandwiches.

They also grow quickly, germinating within two days and ready to harvest in as little as 10 days!

Plus, arugula microgreens contain eight times the calcium, five times the vitamins, and four times the iron as iceberg lettuce!

Broccoli

Broccoli microgreens are one of the most nutritious options, with one study suggesting they have the power to decrease malnutrition.

They’re also one of the fastest growing varieties, as they’ll be ready to harvest in as little as six days

Unlike most other microgreens, the best time to harvest broccoli microgreens, is before their first true leaves form.

Collards

Collard microgreens have a strong flavor, sometimes even more intense than the fully grown vegetable!

Plus, they grow quickly and will be ready for harvest in only 10 days.

Use these thick microgreens as a flavorful addition to salads and sandwiches.

Kale

In microgreen form, kale tastes more like romaine or leaf lettuce, than it’s fully-grown flavor.

Kale microgreens contain four times the nutrients as it does when it’s an adult, so it’s extra healthy too!

Plus, they store well, lasting about a week in the refrigerator—just make sure to keep them dry.

Red cabbage

With their purple coloring, red cabbage microgreens look as good as they taste.

Radish Leaves: Radishes are one of the fastest growing microgreens and ready to harvest in as little as six day.

They taste great too, with the same crisp spicy flavor that mature radishes are famous for

Lettuce

Clover leaves: With petal shaped light green leaf, **Clover** is rich in chlorophyll and amino acid quantities. Harvest in around 10-12 days, can vary according to requirement.

Others: Coriander, Amaranthus, Green Onion, Methi



Editorial

Ongoing Research on Microgreens: Nutritional Properties, Shelf-Life, Sustainable Production, Innovative Growing and Processing Approaches

Massimiliano Renna ¹ and Vito Michele Paradiso ^{2,*}

¹ Institute of Sciences of Food Production, CNR-National Research Council of Italy, Via Amendola 122/O, I-70126 Bari, Italy; massimiliano.renna@ispa.cnr.it

² Department of Biological and Environmental Sciences and Technologies, University of Salento, S.P. 6, Lecce-Monteroni, I-73100 Lecce, Italy

* Correspondence: vito.paradiso@unisalento.it

Received: 18 June 2020; Accepted: 23 June 2020; Published: 24 June 2020



Abstract: Microgreens garner immense potential for improving the nutritional value of the human diet, considering their high content of healthy compounds. On the other hand, they are gaining more and more interest not only for their nutritional value but also for their interesting organoleptic traits and commercial potential. The purpose of this Special Issue is to publish high-quality research papers with the aim to cover the state-of-the-art, recent progress and perspectives related to production, post-harvest, characterization, and potential of microgreens. A broad range of aspects such as cultivation, post-harvest techniques and packaging, analytical methods, nutritional value, bioaccessibility and prospects are covered. All contributions are of significant relevance and could stimulate further research in this area.

Keywords: bioaccessibility; bioactive compounds; Brassicaceae; carotenoids; hydroponic cultivation; mineral elements; polyamine; quality; nitrate; wild edible species

Kitchen waste to compost



Benefits of Composting

- Enriches soil, helping retain moisture and suppress plant diseases and pests.
- Reduces the need for chemical fertilizers.
- Encourages the production of beneficial bacteria and fungi that break down organic matter to create humus, a rich nutrient-filled material.
- Reduces methane emissions from landfills and lowers your carbon footprint.

How to Compost at Home

There are many different ways to make a compost pile; we have provided the following for general reference. Helpful tools include pitchforks, square-point shovels or machetes, and water hoses with a spray head. Regular mixing or turning of the compost and some water will help maintain the compost.

Backyard Composting

- Select a dry, shady spot near a water source for your compost pile or bin.
- Add kitchen waste (vegetable peels, fruit peels, small amounts of wasted cooked food) brown and green materials as they are collected, making sure larger pieces are chopped or shredded.
- Moisten dry materials as they are added.
- Once your compost pile is established, mix grass clippings and green waste into the pile and bury fruit and vegetable waste under 10 inches of compost material.

Optional: Cover top of compost with a plastic sheet or a plank of wood to help retain moisture and heat. When the material at the bottom is dark and rich in color, your compost is ready to use. This usually takes anywhere between two months to two years

Indoor Composting

If you do not have space for an outdoor compost pile, you can compost materials indoors using a special type of bin, which you can buy at a local hardware store, gardening supplies store, or make yourself. Remember to tend your pile and keep track of what you throw in. A properly managed compost bin will not attract pests or rodents and will not smell bad. Your compost should be ready in two to five weeks.

NUTRITIONAL ASPECT OF FOOD PROCESSING AND VALUE ADDITION IN FOOD PRODUCTS

ANITA SINGH¹ AND SANGEETA²

Shri A.K.P.G. College, Varanasi- India

²R.G.W.P.G. College, Akbarpur, Ambedkarnagar -India

ABSTRACT

Nutritional value of food products is very rich when it row, from farm to plate food products passes through different stages of processing. India’s traditional was very sustainable, it contains most of their nutritional values whereas modern processing techniques of cereals, fruits and vegetables, destroy most of the outer layer nutrients. Processing of food is the process of transforming food item into form that can be used for marketing, it cover various physical, chemical activities like mincing, cooking, canning, liquefaction, pickling, macerating and emulsification. Processing in food technology work in very vast domain with various objectives: it boosts the self- life of the food products, prevent contamination, food storage and transportation, it also turn row food materials into attractive food product but there are negative aspect of processing is well known, processed food contains artificial ingredients like sweeteners added salt and preservative which are not good for the health and also diminished nutritional value of food. There are so many benefits of processing and value addition in the products are the best part of the technology, it reduces harmful bacteria that cause infection, dehydrate the food product and alter the pH that prevent the growth of harmful microorganisms. Losses during post-harvest processing hey begin to deteriorate immediately after its separation, these all loses could be added in the food by value addition process in the food products, it also improve profitability of farmers, encourage growth of subsidizing industries, reduce the economic risk of marketing. India as second largest producer of fruits and vegetables, only 10% of that product is being processed where as in other countries it is around 40-50% products which are processed. There are so many techniques which are used for the value addition, fortification, food enrichment enhance the nutritional level of food products.

Key Words: Value added Nutrients, Food Processing, Nutritional aspect, Health.

BIOENERGY, ENVIRONMENT AND SUSTAINABLE DEVELOPMENT

ABDEEN MUSTAFA OMER*

Energy Research Institute, Nottingham NG7 4EU, United Kingdom

Sustainable energy is energy that, in its production or consumption, has minimal negative impacts on human health and the healthy functioning of vital ecological systems, including the global environment. It is an accepted fact that renewable energy is a sustainable form of energy, which has attracted more attention during recent years. A great amount of renewable energy potential, environmental interest, as well as economic consideration of fossil fuel consumption and high emphasis of sustainable development for the future will be needed.

Keywords: Biomass resources, agricultural wastes, energy, environment, sustainable development

Introduction

The increased demand for gas and petroleum, food crops, fish and large sources of vegetative matter mean that the global harvesting of carbon has in turn intensified. It could be said that mankind is mining nearly everything except its waste piles. It is simply a matter of time until the significant carbon stream present in municipal solid waste is fully captured. In the meantime, the waste industry needs to continue on the pathway to increased awareness and better-optimised biowaste resources.

The renewable energy resources are particularly suited for the provision of rural power supplies and a major advantage is that equipment such as flat plate solar driers, wind machines, etc., can be constructed using local resources and with the advantage resulting from the feasibility of local maintenance and the positive influence such local manufacturing has on small-scale rural based industry. This study gives some examples of small-scale energy converters, nevertheless it should be noted that small conventional, i.e., engines are currently the major source of power in rural areas and will continue to be so for a long time to come. There is a need for some further development to suit local conditions, to minimise spares holdings, to maximise the interchangeability of the engine parts and of the engine applications. Emphasis should be placed on full local manufacture.

Bioenergy is a growing source of power that is playing an ever-increasing role in the provision of electricity. The potential contribution of the waste industry to bioenergy is huge and has the ability to account for a source of large amount of total bioenergy production. Woody biomass is usually converted into power through combustion or gasification. Biomass can be specially grown in the case of energy crops. Waste wood makes up a significant proportion of a variety of municipal, commercial and industrial waste streams.

The nations as a whole would benefit from savings in foreign exchange, from energy security, and socio-economic improvements. With a nine-fold increase in forest plantation cover, the nation resource base would be greatly improved. The non-technical issues, which have recently gained attention, include: (1) Environmental and ecological factors (e.g., carbon sequestration, reforestation and revegetation). (2) Renewables as a CO₂ neutral replacement for fossil fuels. (3) Greater recognition of the importance of renewable energy, particularly modern biomass energy carriers, at the policy and planning levels. (4) Greater recognition of the difficulties of gathering good and reliable biomass energy data, and efforts to improve it. (5) Studies on the detrimental health efforts of biomass energy particularly from traditional energy users. There is a need for some further development to suit local conditions, to minimise spares holdings, to maximise interchangeability both of engine parts and of the engine application. Emphasis should be placed on full local manufacture (Abdeen, 2008a).

Energy is an essential factor in development since it stimulates, and supports economic growth and development. Fossil fuels, especially oil and natural gas, are finite in extent, and should be regarded as depleting assets. The efforts are oriented to new energy sources. The clamour all over the world for the need to conserve energy and the environment has intensified as traditional energy resources continue to diminish whilst the environment becomes increasingly degraded. Alternative energy sources can potentially help to fulfill the acute energy demand and sustain economic growth in many regions of the world. Bioenergy is beginning to gain importance in the global climate change fight. The scope for exploiting organic wastes as a source of energy is not limited to direct incineration or refuse-derived fuels burning. Biogas, biofuels and woody biomass are other forms of energy sources that can be derived from organic waste materials. These biomass energy sources have significant potential in the fight against climate change (Abdeen, 2008b).

Conservation of energy and rationing in some form will however have to be practised by most countries, to reduce oil imports and redress balance of payments positions. Meanwhile, the development and the application of nuclear power and some of the traditional solar, wind, biomass and water energy alternatives must be set in hand to supplement what remains of the fossil fuels. The encouragement of greater energy use is an essential development component. In the short-term it requires mechanisms to enable the rapid increase in energy/capita, and in the long term we should be working towards a way of life based on energy efficiency and without the impairment of the environment or of causing safety problems. Such a programme should as far as possible be based on renewable energy resources (Abdeen, 2008c).

Large-scale, conventional, power plant such as hydropower has an important part to play in development. It does not, however, provide a complete solution. There is an important complementary role for the greater use of small scale, rural based-power plants. Such plant can be used to assist development since it can be made locally using local resources, enabling a rapid built-up in total equipment to be made without a corresponding and unacceptably large demand on central funds. Renewable resources are particularly suitable for providing the energy for such equipment and its use is also compatible with the long-term aims (Andrea, and Fernando, 2012; Robinson, 2007).

2. Methods, Materials and Approach

With a view to fulfill the objective, a massive field survey was conducted to assess the availability of raw materials as well as the present situation of biomass technologies. The data were analysed. Agricultural residues recycling helps to reduce the intensity of use of natural resources, decreases the need for waste disposal, decreases the specific energy consumption in manufacturing and also provides reasonable levels of profits for those in the business.

This article highlights the potential energy saving that could be achieved through use of biomass energy source. It also focuses on the optimisation and improvement of the operation conditions.

In compiling energy consumption data it could be possible to categorise usage according to a number of different schemes:

Traditionalsector- industrial, transportation, etc.

End-use- space heating, process steam, etc.

Final demand- total energy consumption related to automobiles, to food, etc.

Energy source- oil, coal, etc.

Energy form at point of use- electric drive, low temperature heat, etc.

The aim of any modern biomass energy systems must be:

To maximise yields with minimum inputs.

Utilisation and selection of adequate plant materials and processes.

Optimum use of land, water, and fertiliser.

Create an adequate infrastructure and strong research and development (R&D) base.

Conclusion

Turning to chemical engineering and the experience of the chemical process industry represents a wakening up but does not lead to an immediate solution to the problems. The traditional techniques are not very kind to biological products, which are controlled by difficulty and unique physico-chemical properties such as low mechanical, thermal and chemical stabilities. Furthermore, investigating the potential is needed to make use of more and more of its waste. Household waste, vegetable market waste, and waste from the cotton stalks, leather, and pulp; and paper industries can be used to produce useful energy either by direct incineration, gasification, digestion (biogas production), fermentation, or cogeneration.

The adoption of green or sustainable approaches to the way in which society is run is seen as an important strategy in finding a solution to the energy problem. The key factors to reducing and controlling CO₂, which is the major contributor to global warming, are the use of alternative approaches to energy generation and the exploration of how these alternatives are used today and may be used in the future as green energy sources. Even with modest assumptions about the availability of land, comprehensive fuel-wood farming programmes offer significant energy, economic and environmental benefits. These benefits would be dispersed in rural areas where they are greatly needed and can serve as linkages for further rural economic development. The nations as a whole would benefit from savings in foreign exchange, improved energy security, and socio-economic improvements. With a nine-fold increase in forest – plantation cover, a nation’s resource base would be greatly improved. The international community would benefit from pollution reduction, climate mitigation, and the increased trading opportunities that arise from new income sources.

References

- Abdeen, M. O. (2008a). Renewable building energy systems and passive human comfort solutions. *Renewable and Sustainable Energy Reviews*, 12(6), 1562-1587.
- Abdeen, M. O. (2008b). People, power and pollution. *Renewable and Sustainable Energy Reviews*, 12(7), 1864-1889.
- Abdeen, M. O. (2008c). Energy, environment and sustainable development. *Renewable and Sustainable Energy Reviews*, 12(9), 2265-2300.
- Andrea, S., and Fernando, R. (2012). Identifying, developing, and moving sustainable communities through renewable energy, *World Journal of Science, Technology and Sustainable Development*, 9(4), 273-281.
- Robinson, G. (2007). Changes in construction waste management. *Waste Management World*, 43-49. May-June 2007.

Acknowledgments

It is a pleasure to acknowledge, with gratitude, all those who, at different times and in different ways, have supported Application of Bioenergy for Energy or Materials: Future Perspective through Energy Efficiency. This article would not have been possible without the contributions of several people. To all of them, I wish to express my gratitude.

Thanks to my wife Kawthar Abdelhai Ali for her warmth and love. Her unwavering faith in me, her intelligence, humour, spontaneity, curiosity and wisdom added to this book and to my life.

OUT SCALING STRATEGIES FOR CLIMATE RESILIENT TECHNOLOGIES

UJJWAL KUMAR, ROHAN KUMAR RAMAN, ABHAY KUMAR & MOHAMMAD MONOBRULLAH
ICAR RESEARCH COMPLEX FOR EASTERN REGION, PATNA, INDIA

Outscaling is a form of technology transfer process through which existing technology is translocated /disseminated from its source or intermediary to the final user. When we talk about upscaling process it means we want to upscale or increase the level of adoption of a technology. In other word it is exposing technology to a wider group of recipients *i.e* beyond the experimental/technology generation group. Sometimes outscaling and upscaling are used synonymously. Generally outscaling is used for dissemination of technology form one system to another or from one locality to other locality for larger coverage in terms of area or number of people. Technology outscaling is achieved through:

Replication Dissemination, spread, or
 Adaptation of techniques,
 Ideas and approaches

Different organizations (SAUs, ICAR, DoA, CIMMYT-BISA,) and programmes (ICAR-NICRA, CGIAR-CCAFS, CSISA, SRFSI, CRA etc) have developed, refined and tested several climate-smart agricultural practices (CSAPs) and demonstrated improved productivity, resilience and adaptive capacity for different commodities and agro-ecological zones within the region. Up scaling of climate resilient technologies (CRT) requires lot of planning and synergies between these three pillars: productivity, adaptation, and mitigation. Therefore, precisely defined adaptation and risk management practices and strategies for resource poor farmers in a community-based approach is critical for future food, livelihood and social security on a sustainable basis.

Table1. Potential Climate Resilient Technologies

Technologies focusing to	Interventions
Water	Precision land leveling, raised beds, bunding, pressurized Irrigation, residue mulching, cropping system optimization, Integrated Fish Farming, SRI
Nutrient	Site Specific Nutrient Management, Green Seeker, Legume integration, LCC, Crop-livestock integration
Energy	No-tillage, Residue Management, cropping system optimization, eliminate puddling in rice, direct seeding in rice
Weather	Weather forecast, seeds for needs, crop diversification, crop insurance
Stress tolerant crops and diversification	Crop diversification, stress tolerant crop varieties that withstand biotic and abiotic stress
Knowledge management	ICTs, Gender Empowerment, Capacity development

Challenges of out scaling:

Many technologies are confined to limited area or adopted by limited stakeholders due to one or another reasons; some of the challenges to upscale climate resilient agricultural technologies are:

Weak linkages among stakeholders engaged in outscaling

Lack of active participation by actual farmers

Inadequate communication plans for promotion of uptake and scaling up;

Inadequate evaluation for uptake and use of desired knowledge;

Inadequate fund and human resources for promotion of uptake and outscaling

Inadequate capacity in promotion of uptake and scaling up;

Failure to link reward and incentive systems to impact;

Insufficient end-user involvement;

Ineffectiveness in the extension systems and the technology dissemination processes.

Poor identification of media and channels for communicating with different stakeholders

There should be proper strategy and plan to combat those challenges of outscaling of climate resilient agricultural technologies and accelerate dissemination process for wider adoption of technologies suited to the area by the stakeholders. Following strategies may be followed for outscaling:

Determination of existing resources

Prioritization of needs

Identification of Knowledge gap

Creating awareness;

Capacity building of field personnel / FIG/ Change agent

Identification of local stakeholders engaged in out scaling

Convergence with ongoing schemes

Linkage for credit

Assurance of need-based inputs

Develop plan for outscaling alongwith target groups

Discuss plan for outscaling with stakeholders

Engaged actors/ agencies responsible/ helpful in outscaling

Follow up / monitoring of outscaling

Popularize success cases as model for outscaling

Identification of stakeholders engaged in agricultural development in the area can help in outscaling of technologies in the area.

Outscaling through Custom Hiring Centres (CHC)

Use of Conservation Agriculturally based farm implements and machineries like, Laser land leveler, Multicrop zero till drills, Happy seeder, bed planter etc. is inevitable for outscaling of climate resilient agriculture. Due to unavailability of these machines with majority of farmers, climate resilient practices are not being followed by the mass. Custom hiring centres established in KVKs, private agencies and with farmers' groups helping resource poor farmers by rent out these machines in affordable cost. These centres also create avenues for income generation to rural unemployed youths.

Table 2. Stakeholder involved in outscaling of Climate Resilient Agricultural Technologies in Bihar

Sector	Organization names	
Public	<u>Government Organization</u> Department of Agriculture ATMA Two Agril Universities and its centers One Animal Sciences University ICAR institute KVKs	<u>Government & CG -Projects</u> DoA responsible for RKVY, NFSM BGREI, Jal Jeevan Hariyali & others state run schemes DoH resp. for National Horticultural & Micro-irrigation Missions National Innovations in Climate Resilient Agriculture (NICRA) NABARD Women Empowerment & Livelihood Programme . CRA programme IRRI CSISA CCAFS BISA-CIMMYT, Pusa
Civil	<u>NGOs/FPO</u> Digital Green, Kaushlya Foundation PRADAN, FnF, etc.	<u>Community & Farmer Organizations</u> SHGs & Village Organizations Women SHGs
Private	<u>Input suppliers/output marketers</u> Retailers at district, block & village level, DoA registered wholesalers, Jain Irrigation and other Agri Machine dealers/ manufacturers	<u>Credit Agencies</u> NABARD Farmer Clubs Commercial banks with PACS (where functional) RRB Micro-credit agencies

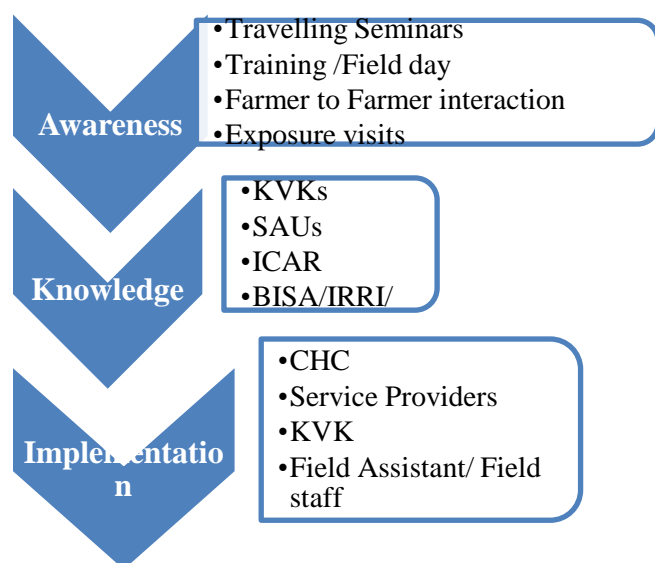

Fig1. Scaling out Climate Resilient Interventions in Bihar

Outscaling through Digital tools

Recent COVID-19 pandemic has proven the power of digital tools as one of the most effective means of communication. Social media, information kiosk, mobile apps, virtual tour and training can be effectively used for outscaling of climate resilient technologies. Digital and sensor-based tools, and drone is widely used for crop monitoring, surveying and mapping the fields, and providing data to farmers for rational farm management plans to save both time and money. Some of other applications including weather forecasting, automated irrigation, intelligent software analysis for pest and disease prediction, soil management and other involved analytical tasks is being through these digital tools.

In Bihar state, block level weekly weather and agro advisory services is being provided to the farmers by KVKs and IMD centers that enable farmers for taking decision and crop planning based on inputs related to weather. Farmers get voice and text messages that inform them of weather forecasts, new seed varieties, climate smart farming practices and tips on improved agricultural practices. Many farmers perceive this as a vital source of information for them on climate change and agriculture.

Approaches for technology outscaling:

Individual to individual: Personal call, farmer to farmer communication, Phone- in-live programme is useful.

Individual to group: Personal calls, farmer to farmers communication, E-Mail, Mobile messages, Exposure visits are useful.

Group to individual: Farmers- Scientist interaction

Group to group: Farmers field school, Exhibitions, Mobile messages, Mass media etc are useful.

Out scaling strategies should be resource based and targeted for different categories of farmers involving women and rural youth. Different stakeholder (farmers, SHGs, NGOs etc) and agencies should be involved for the out scaling. However, integrated and intensified efforts are needed to enhance the adoption rate of climate resilient technologies.

IMPACT OF CLIMATE CHANGE ON INSECT-PESTS

MD. MONOBRULLAH

ICAR Research Complex for Eastern Region, ICAR Parisar, Bihar Veterinary College, Patna-800 014

Impact of climate change on insect-pests population include change in phenology, distribution, community composition and ecosystem dynamics, finally leads to extinction of species. The effect of climate change could either be direct, through the influence that weather may have on the insects' physiology and behavior. In addition, indirect effects can occur through the influence of climate on the insect's host plants, natural enemies and inter-specific interactions with other insects. Climate change related factors have a very strong influence on the development, reproduction and survival of insect pests and as a result it is highly likely that by any changes in climate will affect the insect-pest population. Other changes include expanded pest ranges, disruption of synchrony between pests and natural enemies, and increased frequency of pest outbreaks and upheavals (Parmesan 2007). The quicker the life cycle, the higher will be the population of pests. The general prediction is that if global temperatures increase, the species will shift their geographical ranges closer to the northern pole or to higher elevations, and increase their population size. A key factor regulating the life history pattern of insect pests is temperature. Because insects are poikilothermic (cold blooded) organisms, the temperature of their bodies is approximately the same as that of the environment. Therefore, temperature is probably the most important environmental factor influencing insect behaviour, distribution, development, survival and reproduction.

The increase in temperature due to climate change have impacted insect populations in several complex ways like extension of geographical range, increased over wintering, changes in population growth rate, increased number of generations, extension of development season, changes in crop pest synchrony, changes in inter-specific interactions, increased risks of invasions by migrant pests and introduction of alternative hosts and over wintering hosts. But all these effect of temperature on insects largely overwhelms the effects of other environmental factors (Bale *et. al.*, 2002). Some insects take several years to complete one life cycle and these insects (cicadas, arctic moths) will tend to moderate temperature variability over the course of their life history. It has been estimated that with a 2⁰C temperature increase insects might experience one to five additional life cycles per season (Yamamura and Kiritani 1998). Increased temperature have shown accelerated growth and development of insects damaging the crops, possibly resulting in more generation results in more crop damage per year. Temperature is one of the key factors underlying the geographical distribution of aphids, which are well adapted to regions with a cold winter, during which they survive in the form of eggs having a high level of cold hardiness. These insects multiply only within a certain range of temperatures. The minimum temperature at which aphid development occurs is generally around 4⁰C, but this figure varies within and between species. Optimal temperatures and upper limits are also variable but usually in the range of 20 to 25⁰C and 25 to 30⁰C, respectively. Thus, the rate of development in aphids is directly dependent on temperature. Global warming should therefore, in principle, favour the development of aphid populations. Other biological functions influenced by temperature include dispersal and reproduction. Occurrence of *Helicoverpa armigera* as an invasive pest in Brazil and North America has been attributed to the climate change (Czepak *et al.*, 2013; Tay *et al.*, 2013). Rabindra (2009) reported that the elevated CO₂ levels as well as temperature reduce the activity, longevity, fertility and fecundity of entomophages like parasitoids. Natural enemy and host insect populations may respond differently to changes in temperature. Parasitism could be reduced if host populations emerge

and pass-through vulnerable life stages before parasitoids emerge. Hosts may pass through vulnerable life stages more quickly at higher temperatures, reducing the window of opportunity for parasitism. Temperature may change gender ratios of some pest species such as thrips and potentially affecting reproduction rates (Lewis 1997). Insects that spend important parts of their life in the soil may be gradually affected by temperature changes than those that are above ground simply because soil provides an insulating medium that will tend to buffer temperature changes more than the air (Bale *et. al.*, 2002). Some insects are closely tied to a specific set of host crops. Temperature increases that cause farmers not to grow the host crop any longer would decrease the populations of insect pests specific to those crops. The same environmental factors that impact pest insects can impact their insect predators and parasites as well as the entomopathogens that infect the pests, resulting in increased attack on insect populations.

Another important aspect of climate change is the effect of increasing concentrations of carbon dioxide on crop and pest. Generally, CO₂ impacts on insects are thought to be indirect - impact on insect damage results from changes in the host crop. Indeed, increases in CO₂ concentration stimulate plant growth, but decrease the nutritional quality of plants for phytophagous insects (Lincoln *et. al.*, 1993). Hamilton *et. al.* (2005) found that during the early season, soybeans grown in elevated CO₂ atmosphere had 57% more damage from insects than those grown in today's atmosphere and concluded that the enhanced levels of simple sugars in the soybean leaves under elevated CO₂ may have stimulated the additional insect feeding. Kranthi *et al* (2009) reported *Spodoptera litura* (Fab.) as serious pest under higher levels of CO₂. Some other researchers have observed that insects sometimes feed more on leaves that have lowered nitrogen content in order to obtain sufficient nitrogen for their metabolism (Hunter 2001). Increased carbon to nitrogen ratios in plant tissue resulting from increased CO₂ levels may slow insect development and increase the length of life stages vulnerable to attack by parasitoids (Coviella and Trumble 1999). Whittaker (1999) reviewed the impacts and responses at population level of herbivorous insects to elevated CO₂ and concluded that, the only feeding guild in which some species have shown increases in population density in elevated carbon dioxide are the phloem feeders. Chewing insects (both free-living and mining) generally have shown no change or reduction in abundance, though relative abundance may be greatly affected. Roth and Lindroth (1994) studied the effect of elevated CO₂ on the relationship between the gypsy moth, *Lymantria dispar* and its parasitoid *Cotesia melanoscela* and found that the parasitism mortality was higher in the elevated CO₂ treatments. Precipitation also plays role on insect population. Some insects are sensitive to precipitation and are killed or removed from crops by heavy rains, this consideration is important when choosing management options for onion thrips. Flooding the soil has been used as a control measure for some insects that over-winter in soil (Vincent *et al.* 2003).

References

- Bale JS, Masters GJ, Hodkinson ID, Awmack C, Bezemer TM, Brown VK, Butterfield J, Buse A, Coulson JC, Farrar J, Good JEG, Harrington R, Hartley S, Jones TH, Lindroth RL, Press MC, Symrnioudis I, Watt AD and Whittaker JB (2002). Herbivory in global climate change research: direct effects of rising temperatures on insect herbivores. *Global Change Biology*, 8: 1-16.
- Coviella C and Trumble J (1999). Effects of elevated atmospheric carbon dioxide on insect plant interactions. *Conservation Biology*, 13:700-712.
- Czepak C, Albernaz KC, Vivan LM, Guimarães HO and Carvalhais T (2013). First reported occurrence of *Helicoverpa armigera* (Hübner) (Lepidoptera: Noctuidae) in Brazil. *Pesquisa Agropecuária Tropical*, 43: 110 - 113.

- Hamilton JG, Dermody O, Aldea M, Zangerl AR, Rogers A, Berenbaum MR and Delucia E (2005). Anthropogenic changes in tropospheric composition increase susceptibility of soybean to insect herbivory. *Environmental Entomology*, 34: 479-485.
- Harrington R, Bale JS and Tatchel GM (1995). Aphids in changing climate. In: Harrington R and Stork NE (eds.), *Insects in a changing Environment. 17th Symposium of the Royal Entomological Society*. Academic Press, London, pp. 125-155.
- Hunter MD (2001). Effects of elevated atmospheric carbon dioxide on insect-plant interactions. *Agricultural and Forest Entomology*, 3: 153-159.
- Kranthi KR, Kranthi S, Gopalakrishnan N, Asokan R and Mayee CD (2009). Bt resistance-Its management and prospects in the current context of climate change. In: Ramamurthy VV, Gupta GP, Puri SN (eds) *Proceeding National Symposium on IPM Strategies to Combat Emerging Pests in the Current Scenario of Climate Change*. January 28-30, 2009, Pasighat, Arunachal Pradesh, India pp. 237-261.
- Lewis T (1997). *Thrips as crop pests*. CAB International, Cambridge: University Press. 740 pp.
- Lincoln DE, Fajer ED and Johnson RH (1993). Plant-insect herbivore interactions in elevated CO₂ environments. *Tree*, 8: 64–68.
- Parmesan C (2007). Influences of species, latitudes and methodologies on estimates of phenological response to global warming. *Global Change Biology*, 13: 1860 - 1872.
- Rabindra RJ (2009). Non-chemical insect pest management: A report on the National Symposium on ‘Non-Chemical Insect Pest Management’, conducted by Entomology Research Institute, Loyola College, Chennai, India on 5 and 6 February 2009.
- Roth SK and Lindroth RL (1995). Elevated atmospheric CO₂: effects on phytochemistry, insect performance and insect parasitoid interactions. *Global Change Biology*, 1: 173–182.
- Tay WT, Soria MF, Walsh T, Thomazoni D, Silvie P, Behere GT, Anderson C and Downes S (2013). A brave new world for an old world pest: *Helicoverpa armigera* (Lepidoptera: Noctuidae) in Brazil. *PLoS ONE* 8(11): e80134. doi:10.1371/journal.pone.0080134.
- Vincent C, Hallman G, Panneton B and Fleurat-Lessardú F (2003). Management of agricultural insects with physical control methods. *Annual Review of Entomology*, 48: 261-281.
- Whittakar JB (1999). Impacts and responses at population level of herbivorous insects to elevated CO₂. *European Journal of Entomology*, 96: 149-156.
- Yamamura K and Kiritani K (1998). A simple method to estimate the potential increase in the number of generations under global warming in temperate zones. *Applied Entomology and Zoology*, 33: 289-298.

FUTURE OF DAIRY CATTLE INDUSTRY IN AND AROUND BIHAR IS BY MEGA UTILIZATION OF SEXED SORTED SEMEN

SUMIT SINGHAL^{1*}, A K SINGH¹, AJAY ASWAL, NARENDRA KUMAR, G D SINGH, S K GANGWAR AND A KUNDU

Centre of Excellence on Indigenous Breed, Piprakothi

Dr Rajendra Prasad Central Agriculture University, Pusa, 848 125, Bihar

Dairy husbandry and livestock enterprises are highly potential sector of Indian economy especially of Bihar region. Although some states showed decline in cattle population from 2012 to 2017 but in Bihar there is an increase in livestock population from 32.90 million to 36.5 million (excluding about 0.10 million stray cattle) registering a growth of over 10% in the total number of cattle, directing the scope of animal husbandry in Bihar. In India, population of indigenous/ non-descript cattle increased by about 10% with only marginal (less than 1%) increase in total cattle population. Crossbred female growth was reported about 40% while male population decline by 4% indicating the huge difference might be due to dissimilarities in managerial practices and efforts adopted for rearing the male and female calves.

Issues faced by dairy farmers in and around Bihar:

Rearing male calf with questionable future breeding potential add economic burden on farmer, hence, neonatal male calves are much less cared thereby increase calf mortality.

With advent of AI, it is a fact that less than 0.01% of bulls are utilised for natural breeding purpose thus, 99.99% of male cattle bull are burden under limited managerial resources in Bihar. Furthermore, the male crossbred cattle calves are mostly infertile. These factors lead to more number of stray animals which then spread diseases, increase road accidents, damage to crop fields etc. The undesired male population thereby add burden on farmer's economy, eat away feed fodder, and also produce excreta and emit gases adding the factor to global warming. Mega utilization of sexed sorted semen in and around Bihar for Artificial Insemination will produce more female calves, reduce chances of dystocia, other post-partum complications and increase farmer's confidence towards dairy enterprises and ultimately the income of farmer will get increased. Till date various schemes on breed improvement, progeny testing, dairy entrepreneurship were launched by state government but the progress in terms of genetic gain in these projects were very slow due to undesirable progeny obtained. The mass utilization of sexed semen to produce progeny of desired sex will mitigate the above issues and raise the socio-economic status of farmer. Keeping in view this lead paper is being presented which strongly recommend the use of sexed semen in and around the Bihar.

Technical background of semen sexing:

Clue on semen sexing originated during the period of early Greeks when Democritus, 470-402 BC, emphasised that the left testis produce female, whereas the right testis generate males. Since then, many theories were proposed to demarcate the differences between the male and female producing sperm based on various physio-chemical differences such as size, weight, density, swimming speed, surface macromolecular proteins, electrical surface charges, differential effects of pH, and differing effects of atmospheric pressure etc. Based on these properties some methods were tried practically to separate two type of spermatozoa viz. *Gradient swim-down procedure using albumin* based on 'Y' chromosome bearing spermatozoa is smaller thus exhibit faster downward swimming than 'X' spermatozoa (Ericsson and Ericsson, 1999), *Surface antigenic differences i.e. H-Y antigen* (Blecher *et al.*, 1999), *sex specific proteins on sperm surface* (Hendricksen *et al.*, 1996) *Free-flow electrophoresis* based on electric charge differences on membrane (Kaneko *et al.*, 1984); *Sperm sorting based on*

volumetric differences of sperm heads with ‘X’ being larger than ‘Y’ (van Munster, 2002), *Centrifugal countercurrent distribution* using an aqueous two-phase system (Ollero *et al.*, 2000), *Genetic approaches* (Herrmann *et al.*, 1999), fluorescence in situ hybridization (Karabinus 2009), quantitative PCR (Resende *et al.*, 2011), sort reanalysis (Welch and Johnson, 1999) and the oldest one was Quinacrine mustard method (Barlow and Vosa, 1970). Detail of much of these had discussed by Amann and Seidel (1982). But, all these failed due to one or the other reasons like they suffer from low accuracy, too much time consuming, damage to sperm making them infertile, poor repeatability, lack of suitable scale-up procedures, or other problems preventing their commercialization. The one and only technique found effective is flow cytometry having consistent results of high efficacy (85-95%) in different mammalian species. Later in this literature we will discuss flow cytometry in detail; here are some of the applications of sexing the semen:

The main application of sexed sperm is to breed dairy cattle specially heifers to produce female calves

Conservation of zoo and other wild animals like threatened or endangered animal

In captive breeding programmes there is usually a preference for the production of female offspring because these will be most useful for long-term management of a breeding population and preventing inbreeding

Mimicking those sex ratios occurring in the wild: Example, for species having female-dominated social groups (e.g. gorillas)

where only transient female–male interactions typically at breeding (e.g. elephants and some dolphin species),

captive management of socially cohesive groups is better carried out when animals are housed in groups mimicking those sex ratios occurring in the wild.

For populations in which one sex has more intrinsic value for instance; stud operations and female dairy replacements, or the avoidance of males for pig production, etc.

Flow cytometry: till date the method is costly, slow, has larger wastage of semen and reduced fertility of sorted semen but still the only reliable method with the efficacy of 85-95%. The method is based on the differences in the amount of DNA present in X and Y chromosome bearing spermatozoa. The former being larger contain 3-4% more DNA than the later. This Flow cytometric sex-sorting of sperm according to their DNA content is known as the Beltsville Sperm Sexing Technology and was patented by the USDA (US Patent #692958, 04/26/1991), with Dr. Lawrence Johnson as the inventor.

Earlier, due to unavailability of membrane permeant dye the sperm was demembrated to stain the DNA present in nucleus. This severely damaged sperm due to the aggressive removal of the tail and the membranes during staining with the membrane impermeant dye, 4'-6'-diamidino-2-phenylindole (DAPI; Pinkel *et al.*, 1982) thus compromises the viability during sexing. Later, the sperm were stained with the membrane permeant, bisbenzimidazole DNA binding dye, Hoechst 33342 (Johnson *et al.*, 1987). H33342 usually is excited with the 351 or 364 nm lines of an argon-ion laser or other sources of fluorescence excitation such as mercury lamps. Dead or moribund cells in the population of spermatozoa stained with H33342 can be identified by adding propidium iodide (Johnson *et al.*, 1994) or more recently by adding a non-mutagenic, redfood dye (FD&C40; Johnson and Welch, 1999). The dye quenches the H33342 fluorescence of spermatozoa that have damaged membranes so that they can be removed during the sorting process.

The effectiveness of utilizing DNA content differences between the X- and Y-chromosome carrying sperm depends not only on relative DNA differences, but also on the ability to precisely orient these gametes at the time of measurement in the flow cytometer/cell sorter. Flattened head is more readily oriented than the rounded. Otto *et al.* (1979) reported that one could also get precise DNA content by measuring the sperm head first, termed coaxial

measurement, as utilized by the system. Thus, sperm with flattened head and more difference in DNA amount could be sorted more efficiently. This provides a concept of sorting index; sorting index = DNA difference x area of flat profile of sperm head. The highest sorting index of bull sperm makes it its sorting the easiest.

However, the ability to successfully sort sperm depends on many other factors also viz. the difference in uptake of dye, the relative susceptibilities of gametes to laser exposure, high dilution, elevated pressure and resistance to the several changes in media composition that occur during the sexing process. This makes sex-sorting of sperm not only different for each mammalian species, but differences in sorting efficiency also exist for the sperm of individual males within a species. Since sperm orientation will be random with respect to detectors in a cylindrical stream of fluid, only about 10% of spermatozoa will be sufficiently well oriented for accurate DNA measurements under those circumstances. To achieve better orientation, sperm were passed using a beveled needle to widen and flatten the sample core stream and positioning the sperm head in such a way that the broad surface of the sperm head was perpendicular to the laser beam (Johnson *et al.*, 1989). Only, 20-30% sperm could orient by this method so it was required either to improve the beveled needle or to redesign the nozzle in such a way as to bring the orientation forces lower in the nozzle and closer to the laser beam (Renset *et al.*, 1998). This significantly increased the orientation efficiency from 25% to 60-70%, replacing the beveled needle to orienting nozzle and finally to more improved ceramic version (Cytonozzle1) of the SX MoFlo1 system.

Procedure

Detailed procedures for flow-sorting mammalian spermatozoa are beyond the scope of this text, and depend on the species and application. However, an overview will be provided.

Stained sperm with fluid are pumped with pressure towards nozzle. In nozzle this fluidic stream containing semen is broken into droplets of 70 micron (@ 70,000 -80,000 droplets / sec) by vibration produced by piezo-electric crystals. Thus the droplets formed are of different types: droplets containing no spermatozoa, droplet with single spermatozoa (X or Y), droplet containing no sperm, more than one spermatozoon, damaged sperm, membrane compromised sperm, or sperm that are indistinguishable relative to DNA content droplet with other cells, debris, parts of sperm head, tail etc. Further droplet with ‘X’ or ‘Y’ may be with live or dead spermatozoa. On, laser exposure only the droplet with live spermatozoa (H33342 stained) fluoresce blue and not the dead spermatozoa (stained by PI/ food dye). This is dead cell gating effect of flow cytometry. The fluorescence is in proportion to amount of dye (DNA binding) content in spermatozoa with ‘X’ fluoresce about 4% more brighter. The fluorescence signals are measured by detector (photomultiplier tube) and analyzed by computer. Computer on basis differential fluorescence assign charge (+/-) to each droplet containing spermatozoa; positive charge to Y and negative to X. These were then separated by applying the high voltage electric field. The streams of X- and Y-chromosome-bearing spermatozoa are collected into tubes containing a 22% egg yolk-Tris extender (catch fluid; Schenk *et al.*, 1999) and the third central stream carrying no charge is rejected as waste. Collection tubes are soaked in BSA solution to overcome the sticking of sperm to the wall of the tube. Test-yolk extender (Johnson *et al.*, 1989) in the collection tube is to provide a concentrated environment for the sorted sperm to swim into. This assists in maintaining viability during the sorting process. Centrifugation of the collected sorted sample is done and the sperm pellet is diluted according to its use.

Limitations: there are some sorts of limitations with the technology as well as with the product i.e sexed sorted semen

Accuracy of 90% means 10% chances of error

One spermatozoon is being sorted at a time making the system inherently slow and thereby increasing the cost of sex sorted semen.

Sexing works better with fresh semen so sorters usually are located near the bull

An important point is that about 20% of the sperm sorted are used for quality control purposes or lost post sorting in the supernatant when they are concentrated by centrifugation.

Nearly, half –a – day is required from ejaculate to process single insemination dose of sexed semen meantime the spermatozoa may undergo some damage like premature acrosomal reaction

Lower fertility rate by 20-40% from conventional AI. However, this difference could be reduced to 10% if use of sorted semen is limited primarily to well- managed virgin- heifers because of their inherent higher fertility

Marginal non-significant higher (1-2%) rate of pregnancy losses (13, 22)

The sperm sexing failed if mother could have role in predetermining the sex of offspring.

Embryos produced from sorted sperm develop slower (Lu *et al.*, 1999) and have altered mRNA expression patterns (Morton *et al.*, 2007) however, such embryos showed no DNA damage as evident by Sperm Chromatin Assay of sex-sorted sperm (Garner *et al.*, 2001). Also, calves produced from sorted semen either by conventional AI or by IVF are normal with no complications during parturition and that to the calves born from dam produced by sexed sperm are also normal.

Current status of sexed semen in dairy industry in India: at present two major companies working on semen sorting technology in India mostly under an MoU with line department of Government are as:

	Sexing Technologies	Genus ABS India Pvt. Ltd.
Principle / basis	Flow cytometry	Laser based selective killing of undesired chromosome Sexcell or gender ablation technology
Efficiency	85-90%	85-90%; at present practical results are 90-91% in India
Cost of production	Rs approx 800	Rs approx. 750- 900 in different states
Subsidy by GoI	About 300 at farmers doorstep	About 300
Major states	Uttarakhand; collaboration with BAIF	UP, Haryana, Guajrat, Tripura (latest)
Conception rate	10% less than conventional semen	7- 10% less than conventional semen
Recommendation	In heifer or first lactating	In heifer or first lactating
Limitations	Generalised usage irrespective of parity, thereby, have very poor conception and so farmer discourage the technology	
	Bulk storage at centre due to less utilization by farmer even after subsidy	Due to more progressive farmers, less bulk storage. Moreover, sexed FSD are being sold in Punjab having organised dairy sector.
	Factors: simultaneous running of other beneficial schemes like NAIP-2; conventional AI costing one-tenth and with more conception rate even in pluriparous animals; no scheme to buy back male calf, if born.	
Leading company	Not working on buffalo	Working on buffalo bulls with high genetic merit – Redhu, Babubali, Maharaja. Sexed progeny average MY13 kg/day in first lactation. Sexed semen of these may be used at DLF, GADVASU

Very recently ST genetics has launched mobile sex sorting lab. in India to provide the service at farmers’ doorstep.

Furthermore, research on below mentioned two novel approaches of semen sexing is undergoing but still the practical utility is questionable.

Raman spectroscopy:

It is based on principle of scattering of light caused by the vibration of internal chemical bonds of the cell molecules. It generates chemical information of cell regarding its intrinsic structures like protein, lipid, carbohydrate, nucleic acid without using any external labelling. Spectrum peak and intensities are monitored in different regions of sperm cell. The main variations in Raman peaks are due to varied DNA amount and membrane proteins in X and Y sperms. It represents the "molecular fingerprinting" of a cell with very high sensitivity. Raman spectroscopy enable to discriminate X and Y spermatozoa on basis of their differences in DNA content or sex associated membrane proteins. On this basis, De Luca *et al.*, (2014) claimed that Raman spectroscopy have potential and would be a promising non-invasive technology for sperm sexing with high sensitivity, accuracy and effectiveness.

Lumisort based semen sexing:

Lumisort is the most novel technique which is based on advanced pioneer optical based sorting of X and Y spermatozoa and laser targeted killing of undesired gamete. Dead cells could be then separated to produce the desired sexed semen. It is a non-invasive technology and have no resultant damages due to vibrating, shear, electrostatic, forces which otherwise deteriorate semen quality in flow cytometry. It was used in livestock industry for the first time in 2013 and is also recognised as next generation semen sexing technology.

Future Concerns

During cytometer the major concerns is the metabolic fate of Hoechst 33342, particularly in the non-fertilizing sperm. Although amounts of this dye in the female reproductive tract are minute, it would be desirable to know how the body disposes of this molecule. Of course, sorters with two or more sorting streams may be built in the future. Alternatively, immunological approach may be applied which utilizes antibodies against the sperm carrying specific antigen of one sex to agglutinate or clump together and the free-swimming sperm of the opposite sex can easily be separated and used. Further, the strategies to strengthen the potentials of sorted sperm are needed to be explored. Other technology includes - Aptamer, Gold nanoparticle, ultrasonicator based killing, immunological approach, non-laser based selective killing of Y-sperm, microfluidic separation of sperm would be considered in future for semen sexing.

NATURE-BASED SOLUTIONS FOR AGRICULTURAL SUSTAINABILITY, FOOD SECURITY AND CLIMATE RESILIENCE IN NEH REGION, INDIA

SANJAY-SWAMI

**Soil Science and Agricultural Chemistry, School of Natural Resource Management,
College of Post Graduate Studies in Agricultural Sciences, Central Agricultural University,
Umiam (Barapani) - 793 103, Meghalaya, India**

Nature-based Solutions (NbS) encompasses a variety of practices that, in many cases, have been used for decades, are based on indigenous knowledge or were known under different names like conservation agriculture, climate smart agriculture, etc. Often, the term ‘Nature-based Solutions’ is used as an umbrella concept to cover a range of ecosystem related approaches including ecosystem-based adaptation, natural climate solutions, and green infrastructure. The term itself has received increased attention, with multiple entities working to consolidate definitions, provide principles, educate partners and advance solutions. One of the most common and widely used definitions of NbS comes from the International Union for Conservation of Nature (IUCN) as “actions to protect, sustainably manage, and restore natural or modified ecosystems that address societal challenges effectively and adaptively, simultaneously providing human well-being and biodiversity benefits” (IUCN, 2016).

The IUCN has recently released a global standard for properly deploying NbS, which describes 8 criteria, including attention to a societal challenge, economic feasibility, biodiversity gain and inclusive governance (IUCN, 2016). These criteria and associated indicators help measure the strength of interventions, by ensuring that NbS activities are properly designed and implemented.

In recent years, considerable progress has been made in the area of Nature-based Solutions that improve ecosystem functions of environments and landscapes affected by agricultural practices and land degradation, while enhancing livelihoods and other social and cultural functions. This has opened up a portfolio of NbS options that offer a pragmatic way forward for simultaneously addressing conservation, climate and socioeconomic objectives while maintaining healthy and productive agricultural systems. NbS can mimic natural processes and build on land restoration and operational water-land management concepts that aim to simultaneously improve vegetation and water availability and quality, and raise agricultural productivity (Sonneveld *et al.*, 2018, Sanjay-Swami, 2021a). NbS can involve conserving or rehabilitating natural ecosystems and/or the enhancement or the creation of natural processes in modified or artificial ecosystems (UNWWAP, 2018). In agricultural landscapes, NbS can be applied for soil health, soil moisture, carbon mitigation (through soil and forestry), downstream water quality protections, biodiversity benefits as well as agricultural production and supply chains to achieve net-zero environmental impacts while achieving food and water security, and meet climate goals.

There is a spectrum of nature-based interventions that vary in ecosystem condition – from natural ecosystems to managed or modified ecosystems to novel or artificial ecosystems – as well as in scale, focal purpose and implementing actors. In context of the agricultural and allied

food production systems, Nature-based Solutions (NbS) encompass a broad range of practices that can be deployed directly (Miralles-Wilhelm, 2021). Nature-based Solutions can provide triple benefits when deployed properly, in terms of building agricultural production and resilience, mitigating climate change, and enhancing nature and biodiversity.

Many sustainable practices and approaches drawing on agro-ecological principles (Altieri, 1992; FAO, 2018) or collectively referred to as climate-smart agriculture (Rosenstock *et al.*, 2019), would also fall into this category. In North Eastern Hill (NEH) region of India, the environment, local conditions, socio-economic and socio-cultural life of different tribal communities and their rituals associated with agricultural practices have given basis for development of many indigenous farming systems, which have in-built Nature-based Solutions for conservation, preservation, and utilization of natural resources ensuring agricultural sustainability, food security and climate resilience (Sanjay-Swami, 2019a). The rice-fish system of *Apatani* tribe in Arunachal Pradesh, *Zabo* farming system and *Alder* based farming system in Nagaland, bun cultivation and **bamboo drip irrigation system** in Meghalaya are good examples of location specific Nature-based Solutions in agriculture.

Rice-fish system of Apatani tribe in Arunachal Pradesh

It is a multi-purpose water management system, which integrates land, water and farming system by protecting soil erosion, conserving water for irrigation and paddy-cum-fish culture. The local tribe of Lower Subansiri district of Arunachal Pradesh ‘Apatani’ developed this system. Every stream rising from the hill is trapped soon after it emerges from forest, canalized at the rim of valley and diverted by network of primary, secondary and tertiary channels. The first diversion from the stream takes off at a short distance above the terraces. Central irrigation channel of 0.61 X 0.61 m size and embankment of the same size in each of the paddy plots are constructed. The water into the plots is drawn from irrigation channel and has a check gate made of bamboo splits (huburs) at the inlet for regulation of entry and exit of water through the outlet. For fish culture, a vertical pit is dug in the middle of the plot, so that the water remains in these pits even when it drains away from the surrounding fields. The water from terraces is finally drained into the river, which flows in the middle of valley (Sanjay-Swami *et al.*, 2021).

Zabo farming system in Nagaland

“Zabo” is an indigenous farming system of Kikruma village in Phek district of Nagaland. This is a composite farming system with a combination of forestry, agriculture, livestock, and fisheries. The first component is the top of the hill where forests are maintained. This works as the catchment area for rainwater harvesting. The second component is the area a little down below where the water is collected in ponds that are dug according to the size of the catchment and expected water quantity. The third component consists of livestock enclosures, where the tribal farmers keep their animals in bamboo enclosures. The fourth component is the rice fields-cum-fish, which, at the time of irrigation, get the water from the pond. The water is passed through the livestock enclosures, to enable carrying the dung and urine of the animals to the fields. The half-moon terracing of fields is useful in slope stabilization (Sanjay-Swami *et al.*, 2021).

Alder based farming system in Nagaland

In some pockets of Nagaland, the farmers use *Alnus nepalensis* (Alder) tree for agriculture. In this system, the Alder seedlings are planted on the sloppy land intended for cultivation and the alder grows fast till attain six to ten years old. At this stage initially the trees are pollarded, the leaves and twigs are burnt and ash is mixed with soil to prepare it for raising crops. Subsequently, pollarding is done once every four to six years. Under this process, coppice are cut except five to six on top of the main trunk and crop schedule is followed including fallow period of two to four years. The bigger branches stripped of leaves are used for fire wood, while the root of the tree develop nodules (colonies of *Frankia*) responsible for fertility the soil where as spreading nature of the roots helps in preventing soil erosion in slopes. Nitrogen fixation in *Alnus nepalensis* take place through a symbiotic relationship between *Alnus* with nitrogen fixing actinomycetes of the genus *Frankia* and is, therefore, able to improve degrades *jhum* lands.

Bun cultivation in Meghalaya

Bun cultivation is a modification of shifting cultivation and is mostly followed in the Meghalaya plateau since last four decades. In this system, the crops are grown on a series of raised beds of 0.15-0.30 m height and 0.75-1.0 m width with almost equal width under sunken area made along the slopes, locally referred to as “Bun.” While preparing buns, biomass is burnt under the soil, and the land is abandoned after two or three years. It provides an improved production system, helps conserve soil moisture, and prevents land degradation and soil erosion. In this system, bench terraces are built on the hill slopes running across the slopes. The gap between each bun is levelled using the cut and fill method. The vertical break between each terrace is one meter. Such measures help in preventing erosion and retaining maximum rainwater within the slopes. It also helps in safely dispose-off the additional runoff from the slopes to the lower areas (Sanjay-Swami *et al.*, 2021).

Bamboo drip irrigation system in Meghalaya

The farmers of Meghalaya have developed a unique bamboo drip irrigation system of trapping springs and stream water normally to irrigate the betel leaf or black pepper crops planted in areca nut orchards or in mixed orchards. This system is based on gravity and the steep slopes facilitate in implementing it. Water from an uphill source is trapped and brought to the plantation by a main bamboo channel. Usually these water sources are far off from the plantations and the main bamboo channel runs hundreds of meters. The water is then regulated through a complex bamboo network of secondary and tertiary channels to all the parts and corners of a plantation, right up to the bottom of the hill (Sanjay-Swami, 2021b).

Bamboos of varying diameters are used to build the channels, support structures, diversion pipes and strips. Channels are held above the ground by bamboo or wooden Y shaped sticks. About a third of the outer casing in length and internodes of bamboo pieces have to be removed while fabricating the system. One stretch of channel is lashed to another by thin bamboo strips. Indigenous tools like a *dao*, a type of local axe, and chisels of various shapes and design are used to build the bamboo network. Two laborers can construct a network covering 1 hectare of land in 15 days. They are built with such skill that water wastage by leakage is minimal. The construction is based on a simple thumb rule that the ratio of diameter of primary channel to

tertiary channel determines the quantity of water which will reach the trees. It is a subtle skill which comes with years of observation and experience. It is so perfected that about 18-20 litres of water entering the bamboo pipe system per minute gets transported over several hundred metres and finally gets reduced to 20-80 drops per minute at the site of the plant (Sanjay-Swami, 2021c).

The cost involved in building the system is minimal. Bamboo is available freely in this region. Usually, the farmer himself sets up the system in his plantation with some help from 1 or 2 labourers. The region gets heavy rain and as a result each installation lasts for about 2-3 years. After the rainy season the undergrowth is cleared and reinforcements are provided. Old bamboo is left to rot, which over time returns to the soil as humus. Cooperatives are formed and each farmer provides his skill and labour to build and maintain the system. The distribution of water from one plantation to another is done by diverting water at fixed timings. This avoids the occurrence of conflicts between various farmers. By this method the whole community works harmoniously - sharing the limited resources judiciously (Sanjay-Swami, 2019b).

Conclusion

Depending on how the world’s ecosystems are managed, they can either contribute to the problem or provide effective Nature-based Solutions for the emerging challenges in agriculture. The uniqueness of the Nature-based Solutions is their suitability to the local conditions, their economic feasibility and easy implementation.

References

- Altieri, M.A. (1992). Agro-ecological foundations of alternative agriculture in California. *Agriculture, Ecosystems and Environment*, 39(1): 23-53. [https://doi.org/10.1016/0167-8809\(92\)90203-N](https://doi.org/10.1016/0167-8809(92)90203-N)
- FAO (2018). The 10 elements of agro-ecology guiding the transition to sustainable food and agricultural systems. <http://www.fao.org/3/i9037en/I9037EN.pdf>.
- IUCN (2016). Nature-based Solutions, International Union for Conservation of Nature. In: IUCN [online].
- Miralles-Wilhelm, F. (2021). Nature-based solutions in agriculture: Sustainable management and conservation of land, water, and biodiversity. Virginia. FAO and The Nature Conservancy. <https://doi.org/10.4060/cb3140en>
- Rosenstock, T.S., Rohrbach, D., Nowak, A. and Girvetz, E. (2019). An introduction to the climate-smart agriculture papers. In: T.S. Rosenstock, A. Nowak and E. Girvetz (eds.) *The Climate-Smart Agriculture Papers: Investigating the Business of a Productive, Resilient and Low Emission Future*, pp. 1–12. Cham, Springer International Publishing. https://doi.org/10.1007/978-3-319-92798-5_1
- Sanjay-Swami (2019a). Managing fragile hill ecosystems of North Eastern Region. In: *Soil and Water Conservation Today*, 14(1): 02.
- Sanjay-Swami (2019b). Ecosystem approach to make agriculture more efficient, more sustainable in Meghalaya. In: *Souvenir, CAU Regional Agri-Fair 2019-20*, November 11-13, 2019: 52-57.

- Sanjay-Swami (2021a). Integrated management of land, water and bioresources for sustainable agriculture in North Eastern Region of India. *Grassroots Journal of Natural Resources*, 4 (2): 136-150. <https://doi.org/10.33002/nr2581.6853.040210>.
- Sanjay-Swami (2021b). Bamboo drip irrigation: Coupling tradition and innovation for wider applicability. In: *Soil and Water Conservation Today*, 16 (4): 06-07. ISSN: 0975-4059.
- Sanjay-Swami (2021c). Developing agriculturally vibrant and self reliant (AVSR) NEH. In: *Souvenir, CAU Regional Agri-Fair 2020-21*, March 08-10, 2021: 38-43.
- Sanjay-Swami, Singh, S., Patgiri, P., Raj, V.A. and Singh, T.D. (2021). Ecological sustainability in agricultural production intensification: NER perspective. In: *Sustainable Agriculture: Recent Advances*, (eds.) Sanjay-Swami and Singh, S., Biotech Books, New Delhi, India. pp. 1-20. ISBN: 978-81-7622-493-2.
- Sonneveld, B.G.J.S., Merbis, M.D., Alfara, A., Ünver, I.H.O., Arnal, M.F., and Food and Agriculture Organization of the United Nations. (2018). Nature-based solutions for agricultural water management and food security.
- UNWWAP (2018). *UN World Water Development Report 2018*, the United Nations World Water Assessment Programme, Paris, UNESCO. <https://www.unwater.org/publications/world-waterdevelopment-report-2018/>).

THE SUCCESS STORIES
DECENTRALIZED SYSTEMS FOR WASTE WATER & SOLID WASTE
MANAGEMENT

MR. VIKRAM DESHMUKH (PUNE, MAHARASHTRA INDIA)

1. **Background & challenges**
Impact of rapid urbanization, environmental Impact, untreated Domestic waste water, Food/ kitchen waste problems, Waste handling,
2. **Necessity, Concept & Laws:-**
Institutional/individual social responsibility, Environmental Laws, source segregation ,Norms
3. **Methods / Techniques / solution used**
Bio Mechanical process, various techniques used.
4. **Examples/list of projects**
Project successfully completed & running, some success stories, list
5. **Benefits/summary**
3 R concept- Reduce Reuse Recycle, employment generation, sustainable alterable systems & Economic Opportunities, For Betterment of agriculture & environment

SUCCESS STORY 1

TITLE:- RECYCLING OF TREATED WASTE WATER FOR TOILET FLUSHING & COOLING PURPOSE AT MALL

Location: - Phoenix Market city Mall Vimannagar Pune Maharashtra India 411014

Summary: - waste water/domestic sewage generated from mall kitchen, bathroom, toilet is being treated by Extended aeration type Sewage Treatment plant and then final treated water is further recycled & reused for Landscape garden, Toilet flushing, Cooling system and successfully save fresh water use up to 7 Lakh lit per day.

Background: - Phoenix mall is largest mall in Pune where around 10 Lakh Lit per day of waste water is generated. Earlier total water was being wasted and used to be send to local drain due to some basis design & operational error. So many attempts were made before mall. Was Also purchasing 25 to 50 fresh water tanker per day.

Initiative: Mall administration and Vikram Deshmukh took initiative for rectification & revamping of Sewage treatment system.

Action/work:- Work order was placed to Mr. Vikram Deshmukh for rectification of basic design. After some minor changes in settling tank, and in tertiary treatment of micron filtration with ozone system. STP plant was Recommissioning and stated with full capacity.

Result/success: - As result of all rectification and revamping work, STP now is generating around 5 to 7 lakh lit treated water per day which not only matches with Pollution control Boards norms but also matches with WHO norms for reuse purpose Now Mall tanker intake is reduced to Zero.



**Mall Waste water Recycling: -
Waste Water Analysis Reports**

Parameters	Inlet Results	Outlet Results	Unit	MPCB Standards
PH	7.1	7.3	--	7-8
Total Suspended Solids	210	9	mg/lit	<10
Total Dissolved Solids	565	324	mg/lit	<2100
Chemical Oxygen Demand (COD)	142	43	mg/lit	<250
Biological Oxygen Demand (BOD)	39	8	mg/lit	<30



Success Story 2

Title:

Modification of sewage Treatment System for Hotel waste water Treatment & Reuse

Location:

Radisson Blu Resort Karjat District: - Raigad Maharashtra India 401201

Summary: - Waste water sewage generated from hotel kitchen, Rooms Toilet & bath is treated Simple Sequential Batch Reactor Method (SBR) then passed through Sand and carbon filters for further use to Large Garden area in resort.

Background: - Resort hotel Sewage Handling system was failed due to complicated automatic Membrane bio reactor system which was not in operation for 5 years and untreated waste water was pump to open space nearby Then this untreated waste water was subsequently percolated to River adjacent to resort which was creating nuisance to all human and hazards to environment This earlier system was very difficult to repair /maintain also was difficult to modify due to existing civil structure.

Initiative: Due to Pressure from local villagers Resort management initiated in the STP work. After visit and proposal given by Mr Vikram Deshmukh Resort management placed work order for modification & conversion of waste water treatment technology.

Action/work: - Modification and conversion of waste water treatment system done by simple addition of one civil wall and addition of some pumping system.

Result/success: -After modification work, STP started generating good quality treated water which further reuse for large landscape garden & Horticulture plantation in resort.

Resort Waste water Treatment:-

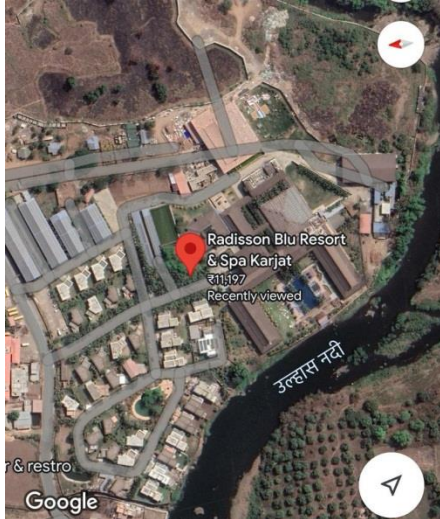

SUCCESS STORY 3

TITLE :- IMPLEMENTATION OF VILLAGE WASTE WATER
SANITATION SYSTEM

(GRAY WATER TREATMENT & DISPOSAL)

Location :- At Post:- Rui Taluka Koregaon District :- Satara Maharashtra India
415501

Summary : - Gray water Generated from household (kitchen & bathroom) treated and dispose Through Soak pit for proper village sanitation & environmental protection.

Background: -Small village of population 1600 where from around 250 houses all waste water was discharge to open gutter or open area in village which was very unhealthy and hazard to surrounding environment.

Initiative: Panni Foundation (NGO) start mission under which Rui village/people participate in water cup 2018 . Soak pit implementation work started by people’s participation through shramdaan / voluntary contribution by the person towards community welfare involving physical effort.

Action/work - First door to door Awareness campaign start at village level. From people’s contribution RCC soak pit tank was ordered in lot quantity. Villagers & other group of people come together to do this work.

Result/success: - Around 90 % Houses from Rui village adopt this technique which result into neat clean village and surrounding environment, for better health of villagers.

Soak Pit Implementation



:-





SUCCESS STORY 4

TITLE: - CONVERSION OF FOOD WASTE INTO ORGANIC COMPOST BY BIO MECHANICAL METHOD.

Location: - Pune Municipal corporation Aundh ward District: - Pune Maharashtra India 401201

Summary: - At source segregated Solid waste generated from hotel & Vegetable market treated by Bio mechanical composting Method (OWC) and convert into rich organic compost which further use for agriculture & landscaping purpose.

Background: - Earlier food waste generated from hotel and vegetables market waste was getting mixed with other waste and was sent to dump yard or to centralized common waste processing plant. There was no source segregation in earlier system. No conversion or proper scientific treatment of solid waste. Centralized system has more higher in transport cost, handling cost which create nuisance to all human and also hazards /pollution to environment.



Initiative: Due to Pressure from local villagers(dumping place) and other Environmental laws Pune municipal corporation initiated this work and installed OWC plant which was design by Excel biotech then developed & maintained by 3 R waste management/ Vikram Deshmukh

Action/work: - Segregated Food waste from hotel and vegetable waste from ward market yard collected by pick up van and then treated by accelerated Bio Mechanical Process which convert waste into rich organic compost within 10 days of aerobic Decomposition process.



Result/success: - Successfully converting 1 MT food waste & vegetable waste per day into organic compost which is further send to garden and farmers for agriculture Use

Food waste Composting Plant :-
Compost Analysis Report



Figure Raw compost

	<i>Parameters</i>	<i>Result</i>	<i>FCO Standards</i>
Physical	PH	7.37	6.5-7.5
	Maturity Test	Positive	--
	Moisture %	23	15-25
	Bulk Density g/cc	0.48	< 1.0
	Electrical Conductivity	4.3	<4.0
Chemical	C:N Ratio	13:1	<20:1
	Organic Matter %	78.84	
	Nitrogen %	3.63	0.8 (min)
	Organic Carbon %	45.73	12 (min)
	Total Phosphorus %	1.49	0.4(min)
	Potassium %	1.99	0.4 (min)

**EFFECT OF ELEVATED CONDITIONS ON *FUSARIUM OXYSPORUM* INCITING
WILT OF PEA (*Pisum sativum* L.)**

**K. CHAKRAPANI, ¹BIRESWAR SINHA, BIJEETA THANGJAM, TAMPACLEIMA
CHANU, TUSI CHAKMA, SHOBITA DEVI, LNK SINGH, ZARZOLIANA RALTE**

¹Department of Plant Pathology, College of Agriculture, CAU, Imphal

²Department of Genetics and Plant Breeding, College of Agriculture, CAU, Imphal

ABSTRACT

Pea (*Pisum sativum* L., 2n=14) is one of the most important pulse crops. It occupies the second place in terms of cultivation among all the pulse crops after common bean across the world. Indian contribution to the pea production is at utmost level in terms of area and production. The malady wilt induced by *Fusarium oxysporum* f. sp. *pisi* imparts a devastating loss in pea production. The effect of elevated conditions of temperature, pH and nitrogen sources are being carried out due to drastic climate change round the globe. The growing medium pH was altered using 1N Sulphuric acid and 1N Sodium hydroxide to 3, 4, 5, 6, 7, 8 and 9. The plates were inoculated and incubated in BOD incubators at specified temperatures 21, 23, 25, 27, 29, 31, 33° C. Among the effects of elevated levels of pH and temperatures accompanied with elevated levels of temperatures, the combination of pH: 6-7 at the temperature of 25 °C depicted the highest growth of the fungus with highest no. of conidia.

Keywords: Pea, wilt, *Fusarium oxysporum* f. sp. *pisi*, Temperature, pH, Nitrogen source.

PRECISION POULTRY FARMING TO IMPROVE PRODUCTIVITY

ANIL KUMAR AND ANKIT SHARMA

Department of Livestock Production Management, College of Veterinary and Animal Sciences, GBPUAT, Pantnagar -263145, Uttarakhand, India

Poultry livestock farming (PLF) is defined as the collecting of data from animals and their environment using innovative, simple, and low-cost procedures, followed by data interpretation utilising knowledge-based computer models. Because of the enormous number of animals involved and the potential for welfare improvements, poultry farming, particularly broiler farming, is an important sector in which to focus efforts on increasing welfare. Poultry farms have the largest farm animal populations, with tens of thousands of birds in a single barn. It should also be noted that the use of PLF principles in the egg industry might be referred to as Precision Poultry Farming (PPF). PPF, in turn, has the potential to boost production efficiency while simultaneously improving animal welfare and health, as well as lowering the environmental effect of chicken production. monitoring of CO₂ concentrations, temperature, humidity, and other environmental parameters in large-scale chicken farms, with the goal of developing a new monitoring technology. sequential precision feeding (PF) system could manage the body weight (BW) of individual group housed pullets by matching real-time BW to BW targets, as well as measure metabolic rate changes utilising continuous or stepwise increases in target BW. PLF has yet to become a widespread commercial reality in the poultry industry, despite rising research output. The commercialization of PLF systems in the poultry sector, as well as their potential for boosting positive welfare, should be the focus of future research. Precise management gives farmers opportunities for reliable, real-time and non-invasive measurements of birds' behaviour and physiology by integrating many technology solutions.

Introduction:

The phrase "precision livestock farming" (PLF) was coined in the early twenty-first century, with the first PLF conference held in 2003 (Werner et al., 2003). Many distinct definitions of the term have been developed and used in the literature since its introduction. The authors developed the following definition based on the main shared aspects of the various definitions: PLF refers to the use of technology to automatically monitor livestock, their products, and the farming environment in real time in order to improve farm management by providing appropriate data on which to make management decisions or by activating automated control systems. PLF, according to Berckmans (2008), is defined as the collecting of data from animals and their environment using innovative, simple, and low-cost procedures, followed by data interpretation utilising knowledge-based computer models. In PLF, 'precision' refers to controlling processes. As the process becomes more precise with control over production processes, PLF can help farmers increase their productivity and profitability. The main advantage of the PLF system, according to Banhazi and Black (2009), is that it ensures that “every process within a livestock enterprise, which can have a large positive or negative effect on profitability and productivity, is always controlled and optimised within narrow limits.” PLF technology have the ability to increase output while also improving animal welfare. PLF enables non-intrusive welfare assessment, allowing data to be acquired without the stress of disturbing or handling animals (Wathes et al., 2008). Continuous monitoring, rather than a snapshot in time like typical human assessments, can provide a more thorough view of the overall welfare state of animals (Winckler, 2019). While the potential for PLF to improve animal welfare has been highlighted, it is unclear whether the purpose of PLF development in poultry has been to promote welfare or to increase production efficiency. Benefits in welfare can be connected to improvements in output, for example by reducing mortality (Dawkins,

2017), therefore PLF systems can strive to increase both animal welfare and production. PLF is not meant to boost productivity at the expense of animal health and well-being, which is critical from an animal welfare perspective.

Because of the enormous number of animals involved and the potential for welfare improvements, poultry farming, particularly broiler farming, is an important sector in which to focus efforts on increasing welfare. As a result of their rapid growth rate (Bessei, 2006; Knowles et al., 2008), which has grown by 400 percent through breeding programmes since the 1960s (Zuidhof et al., 2014), modern broilers suffer from diseases such as sudden death syndrome, ascites, lameness, and contact dermatitis. Broilers are the world's most populous bird, with a population of 22.7 billion individuals, an order of magnitude larger than any other farmed species (Bennett et al., 2018). Poultry farms have the largest farm animal populations, with tens of thousands of birds in a single barn. Each individual animal is worth very little, and flock turnover is quite quick, with new broiler strains achieving their target weight in just 5–6 weeks or less in conventional intensive production systems (Wilhelmsson et al., 2019). This indicates that concern for the welfare of a single bird may be minimal. Poultry farmers have a narrow profit margin, which adds to the conflict between production and bird welfare.

While the number of chickens raised for meat is now enormous, meat consumption is expected to rise in the future, owing to a growing human population as well as rising earnings and urbanisation (Scholten et al., 2013). As a result, poultry farming is expected to grow in low-income nations where animal welfare may not yet be a concern. In comparison to other meat categories, poultry meat consumption has increased. Beef, pork, and sheep meat consumption levels in the OECD (Organisation for Economic Co-operation and Development, Paris, France), an organisation of 36 countries, have barely changed between 1990 and 2017. The consumption of poultry meat, on the other hand, has climbed by 70.5 % (OECD, 2019). It should also be noted that the use of PLF principles in the egg industry might be referred to as Precision Poultry Farming (PPF). PPF, in turn, has the potential to boost production efficiency while simultaneously improving animal welfare and health, as well as lowering the environmental effect of chicken production. The Australian Egg Corporation Limited (Banhazi, 2005) recognises that developing an integrated data analysis tool for the egg business is a potentially critical upgrade that can improve farm management standards. With real-time monitoring of birds' actions, the PLF system can make changes to poultry house equipment (including feeders, fans, heating systems, and sprinklers) depending on the recorded data (Mollo et al., 2009). This will lead to improvements in animal health, animal welfare, farm and chain quality assurance, and risk analysis and risk management (Berckmans, 2008).

Advancements in poultry monitoring tools:

Barbosa Filho et al. (2008) studied the image analysis for welfare evaluation of laying hens in different breeding systems and environmental conditions. Video cameras were used to record bird behaviour during the evaluation period. de Moura et al. (2008) developed a relationship between thermal comfort and chick performance using noise analysis. Okada et al. (2010) used a wireless sensor node with a temperature sensor and an accelerometer to assess the availability of a method for detecting chickens infected with highly pathogenic avian influenza (HPAI) viruses at an early stage in poultry farms. The simulation revealed that the infection can be detected before more than about 10 hours of the death and that 1 axis acceleration measurement is sufficient. Dong and Zhang (2010) investigated the monitoring of CO₂ concentrations, temperature, humidity, and other environmental parameters in large-scale chicken farms, with the goal of developing a new monitoring technology. It can boost poultry farm production and quality, increase automation, minimise production costs, and reduce labour intensity. Mollah et al. (2010) investigated the feasibility of calculating live broiler body weight using computer assisted digital image analysis. The photos were examined using raster image analysis software (IDRISI 32) to identify the broiler's body surface area and a linear equation was devised to

estimate the broiler's weights from its body surface-area pixel. Up to 35 days of age, the estimated body weights did not differ significantly ($p > 0.05$) from manually measured body weights. As a result, it is possible to design a practical imaging system for weighing live broilers. Ferreira et al. (2011) investigated the efficacy of infrared thermography images in determining the loss of sensible heat in young broilers given various dietary energy levels. Twenty birds were reared using infrared lamps in a housing with proper brooding. In a completely randomised trial, birds were divided into two groups: T₁ (control diet with 2950 kcal ME/kg⁻¹) and T₂ (high-energy diet with 3950 kcal ME/kg⁻¹). The average surface temperature of the body region was determined using data collected from 100 spots (50 in the front and 50 on the lateral side of the bird's body). The young broilers fed the high-calorie diet lost 0.64 kcal h⁻¹ in metabolic energy, while the birds fed the control diet lost 2.18 kcal h⁻¹, according to the findings. This data supports the theory that adding oil to the diet minimises heat loss in birds. When young broilers were fed diets with various energy levels, the infrared camera was able to record the variation in surface temperature. Stefanova (2019) describes the creation of a precision livestock management information technology framework that may be used to construct new and different livestock management software applications. The zootechnical diary is an online platform that provides monitoring and collaboration capabilities to improve the health and welfare of laying hens on industrial poultry farms. It uses cloud technology to connect egg and breeding farms, allowing for continuous data collection, automatic comparisons of actual and expected production indicators, e-networking, and integrated data flow between the two parties. Egg farms benefit from management precision, quick input on animal health, and economic rewards, while breeding farms profit from increased competitiveness and stronger supplier-client relationships.

Bird Welfare and Environmental Conditions:

Eits et al. (2005) developed an economic model that evaluates the impact of balance protein (DBP) content in the diet on feed costs, revenues, and thus 'returns over feed cost' per bird. According to the findings, feeding for maximum profit rather than maximum performance can significantly boost the profitability of a broiler manufacturing business. Only variations in age period, price of protein-rich raw materials, and major changes in meat prices necessitate adaption of the DBP contents to maintain maximum profitability once these diets have been formulated for maximum profit. Sakomura et al. (2005) developed and tested a model for estimating metabolizable energy needs and determining broiler growth parameters. Response surface models, as proposed by Faria Filho et al. (2008), allow for the simultaneous analysis of several components using first and second order polynomials, as well as the assessment of the interaction between the factors in the study. Faria Filho et al. (2008) found that response surface models are effective in predicting weight gain and feed conversion in broilers, and that the models also allowed for the determination of dietary protein levels, rearing temperature, and slaughter age that would yield the highest profit under different market conditions. The most fundamental form of regulating the poultry environment, according to Mutai et al. (2011), is to maintain an appropriate temperature in these facilities by altering ventilation and heating rates accordingly. According to Teagasc (2011), the heating and ventilation systems should be linked to avoid them competing with one another. Excessive ventilation in poultry houses, particularly during cold weather seasons, can drastically increase heating energy requirements and up to 30% increase operating expenses, according to Teagasc (2011). Sadeghi et al. (2015) used an intelligent system based on chicken vocalisation to detect and classify chickens infected with *Clostridium perfringens* type A. Using a microphone and a data collecting card, chicken vocalisation was captured every morning at 8 a.m. for 30 days under equal and controlled settings. The performance of the neural network was determined using these features as inputs. The findings demonstrated the utility and efficacy of intelligent approaches for

diagnosing poultry diseases, allowing for early treatment of sick birds before the sickness spreads further.

Precision feeding in poultry:

Olaniyi et al. (2016) used a Particle Swarm Optimization (PSO) adjusted Proportional Integral Derivative (PID) control technique to design a mobile intelligent poultry feed dispensing system. The system can be used by farmers to easily administer both solid and liquid feed to poultry birds with a high return on investment, high yield, and profit after successful testing and performance evaluation. Farmers can use the developed mechatronic technology to lessen the high amount of human involvement in chicken feeding. Zuidhof et al. (2017) investigated whether a sequential precision feeding (PF) system could manage the BW of individual group housed pullets by matching real-time BW to BW targets, as well as measure metabolic rate changes utilising continuous or stepwise increases in target BW. Even though all of the birds were confined in the same pen, the PF system was able to monitor feed intake of the two experimental treatments individually. In an experiment, broiler breeders were fed amounts of feed that corresponded to their daily intake allocation (but were not balanced to their daily nutrient demand) (Zuidhof, 2018). Maintaining and controlling daily feed intake is critical in breeder production to ensure the longevity and fertility of the animals. Precision feeding increased feed efficiency by 4.6 %, saving almost \$60 million in Australian industry figures by avoiding the production of 145,000 tonnes of feed. Furthermore, precision feeding of broiler breeders has been shown to reduce variation in flock uniformity to less than 2% (Zuidhof et al., 2017), and may provide bird welfare benefits by avoiding skip-a-day feeding (Mench, 2008). In order to establish which controller is more efficient and effective, Bala et al. (2019) compared the Fuzzy Logic Controller (FLC) and the Proportional-Integral-Derivative (PID) Controller on the Poultry Feed Dispensing System. The system with the PID and FLC performed better than the system without a control approach, according to the results. They demonstrated that the PID controller is better for solid feed systems and the FLC is better for liquid feed systems.

Conclusion:

The development of PLF systems for poultry farming, particularly broilers and laying hens, has gotten a lot of interest around the world, especially in the United States, China, and Belgium, with the majority of studies focusing on improving animal health and welfare. PLF has yet to become a widespread commercial reality in the poultry industry, despite rising research output. The commercialization of PLF systems in the poultry sector, as well as their potential for boosting positive welfare, should be the focus of future research. Several obstacles must be overcome before farmers and consumers accept these technologies widely. Precise management gives farmers opportunities for reliable, real-time and non-invasive measurements of birds' behaviour and physiology by integrating many technology solutions. Automated techniques to assess physiological and behavioural parameters can provide invaluable benefits and tools to maximise poultry welfare by providing better alternatives to evaluate bird health and response, thereby minimising production losses. The machine learning process and data analysis for large-scale, more sensitive and resistant sensors utilised in PLF, and teaching potential users who need the essential abilities to apply such solutions are among the key hurdles. Hi-tech poultry production farms can help connect farmers' and consumers' interests while putting a greater focus on improving poultry welfare.

References:

Aerts, J. M.; Berckmans, D.; Saevels, P.; Decuyper, E. and Buyse, J. (2000). Modelling the static and dynamic responses of total heat production of broiler chickens to step changes in air temperature and light intensity. *British poultry science*, 41: 651- 659.

- Bala, J.; Olaniyi, O.; Folorunso, T. and Arulogun, O. (2019). Poultry Feed Dispensing System Control: A Case between Fuzzy Logic Controller and PID Controller. *Balkan Journal of Electrical and Computer Engineering*, 7 (2): 171-177 .
- Banhazi, T. (2005). A National Workshop on “Precision Poultry Farming” in Australia, s.l.: Australian Egg Corporation Limited.
- Banhazi, T. M. and Black, J. L. (2009). Precision Livestock Farming: A Suite of Electronic Systems to Ensure the Application of Best Practice Management on Livestock Farms. *Aust. J. Multi-Discip. Eng.* 7: 1–14.
- Barbosa Filho, J. A. D.; Silva, I. J. O. and Silva, M. A. N. (2008). Welfare evaluation by image analysis of laying hens in different breeding systems and environmental. unpaginated.
- Bennett, C. E.; Thomas, R.; Williams, M.; Zalasiewicz, J.; Edgeworth, M.; Miller, H.; Coles, B.; Foster, A.; Burton, E. J. and Marume, U. 2018. The broiler chicken as a signal of a human reconfigured biosphere. *R. Soc. Open Sci.* 5: 180325.
- Berckmans, D. (2008). Precision livestock farming (PLF). *Computers and Electronics in Agriculture*, 62: 1.
- Bessei, W. (2006). Welfare of broilers: A review. *Worlds. Poult. Sci. J.* 62: 455.
- Dawkins, M.S. (2017). Animal welfare and efficient farming: Is conflict inevitable? *Anim. Prod. Sci.* 57: 201.
- De Moura, D. J.; Naas, I. D. A.; Alves, E.; De Carvalho, T. M. R.; Do Vale, M. M. and De Lima, K. A. O. (2008). Noise analysis to evaluate chick thermal comfort. *Scientia Agricola*, 65, 438-443.
- Dong, F. and Zhang, N. (2010). Wireless Sensor Networks Applied on Environmental Monitoring in Fowl Farm. Computer and Computing Technologies in Agriculture III. In: Sensors, 2005 IEEE, Oct. 30 2005-Nov. 3. 4 pp.
- Eits, R. M.; Giesen, G. W. J.; Kwakkel, R. P.; Verstegen, M. W. A.; and Den Hartog, L. A. (2005). Dietary balanced protein in broiler chickens. 2. An economic analysis. *British Poultry Science*, 46(3): 310–317.
- Faria Filho, D.; Rosa, P.; Torres, K.; Macari, M. and Furlan, R. 2008. Response surface models to predict broiler performance and applications for economic analysis. *Braz. J. Poult. Sci.*, 10(2): 139-141.
- Ferreira, V.; Francisco, N.; Belloni, M.; Aguirre, G.; Caldara, F.; Nääs, I.; ...and Polycarpo, G. (2011). Infrared thermography applied to the evaluation of metabolic heat loss of chicks fed with different energy densities. *Revista Brasileira de Ciência Avícola*, 13(2): 113–118.
- Knowles, T. G.; Kestin, S. C.; Haslam, S. M.; Brown, S. N.; Green, L. E.; Butterworth, A.; Pope, S. J.; Pfeiffer, D. and Nicol, C. J. (2008). Leg Disorders in Broiler Chickens: Prevalence, Risk Factors and Prevention. *PLoS ONE* 3: e1545.
- Mench, J. A. (2002). Broiler breeders: feed restriction and welfare. *Worlds Poult Sci J.* 58: 23-29.
- Mollah, M. B. R.; Hasan, M. A.; Salam, M. A. and Ali, M. A. (2010). Digital image analysis to estimate the live weight of broiler. *Computers and Electronics in Agriculture*. 72(1): 48–52.
- Mollo, M. N.; Vendrametto, O. and Okano, M. T. (2009). Precision Livestock Tools to Improve Products and Processes in Broiler Production: A Review. *Brazilian Journal of Poultry Science*. 11: 211- 218.
- Mutai, E. B. K.; Otieno, P. O.; Gitau, A. N.; Mbugu, D. O. and Mutuli, D. A. (2011). Simulation of the microclimate in poultry structures in Kenya. *Research Journal of Applied Sciences, Engineering & Technology*. 3(7): 579-588.
- OECD Meat Consumption (Indicator). Available online: <https://data.oecd.org/agroutput/meat-consumption.htm> (accessed on 8 May 2019).

- Okada, H.; Suzuki, K.; Kenji, T. and Itoh, T. (2010). Avian influenza surveillance system in poultry farms using wireless sensor network. Design Test Integration and Packaging of MEMS/MOEMS (DTIP), 2010 Symposium on, 5-7 May 2010. 253-258.
- Olaniyi, O. M.; Folorunso, T. A.; Kolo, J. G.; Arulogun, O. T.; Bala, J. A. (2016). “A Mobile Intelligent Poultry Feed Dispensing System Using Particle Swarm Optimized PID Control Technique” Proceedings at ISTEAM Multidisciplinary Cross Border Conference University of Professional Studies, Accra Ghana, pp 185-194.
- Sadeghi, M.; Banakar, A.; Khazaei, M.; and Soleimani, M. (2015). An Intelligent Procedure for the Detection and Classification of Chickens Infected by *Clostridium Perfringens* Based on their Vocalization. *Revista Brasileira de Ciência Avícola*. 17(4): 537–544.
- Sakomura, N.; Longo, F.; Oviedo-Rondon, E.; Boa Viagem, C.; and Ferraud, A. (2005). Modeling energy utilization and growth parameter description for broiler chickens. *Poult. Sci.*, 84(9): 1363-1369.
- Scholten, M. C. T.; de Boer, I. J. M.; Gremmen, B. and Lokhorst, C. (2013). Livestock Farming with Care: Towards sustainable production of animal-source food. NJAS-Wageningen. *J. Life Sci.* 66: 3–5.
- Stefanova, M. (2019). Precision Poultry Farming: Software Architecture Framework and Online Zootechnical Diary for Monitoring and Collaborating on Hens’ Health. *Kidney Organogenesis*. 191–205.
- Teagasc. (2011). Energy use in agriculture. Oak Park, Carlow: Teagasc. Available from: http://www.teagasc.ie/publications/view_publication.aspx?PublicationID=1037.
- Wathes, C. (2007). Precision livestock farming for animal health, welfare and production. Tartu: Estonian University of Life Sciences, Jõgeva Plant Breeding Institute, Estonian Research Institute of Agriculture.
- Wathes, C. M. (2007). The prospects for precision livestock farming. Royal Agricultural Society of England, 171: 26-32.
- Wathes, C. M.; Kristensen, H. H.; Aerts, J. M. and Berckmans, D. (2008). Is precision livestock farming an engineer’s daydream or nightmare, an animal’s friend or foe, and a farmer’s panacea or pitfall? *Comput. Electron. Agric.* 64: 2–10.
- Werner, A.; Jarfe, A.; Stafford, J. V.; Cox, S. W. R.; Sidney, W. R. Programme Book of the Joint Conference of ECPA-ECPLF: 1st European Conference on Precision Livestock Farming and 4th European Conference on Precision Agriculture; Wageningen Academic: Berlin, Germany; Wageningen, The Netherlands, 2003; Available online: <https://www.worldcat.org/title/programme-book-of-the-joint-conference-of-ecpa-ecplf/oclc/71312068> (accessed on 8 May 2019).
- Wilhelmsson, S.; Yngvesson, J.; Jönsson, L.; Gunnarsson, S. and Wallenbeck, A. (2019). Welfare Quality® assessment of a fast-growing and a slower-growing broiler hybrid, reared until 10 weeks and fed a low-protein, high-protein or mussel-meal diet. *Livest. Sci.* 219: 71–79.
- Winckler, C. (2019). Assessing animal welfare at the farm level: Do we care sufficiently about the individual? *Anim. Welf.* 28: 77–82.
- Zuidhof, M. J. (2018). Lifetime productivity of conventionally and precision-fed broiler breeders. *Poultry Science*.
- Zuidhof, M. J., Fedorak, M. V., Ouellette, C. A., & Wenger, I. I. (2017). Precision feeding: Innovative management of broiler breeder feed intake and flock uniformity. *Poultry Science*. 96(7): 2254–2263.
- Zuidhof, M. J.; Schneider, B. L.; Carney, V. L.; Korver, D. R. and Robinson, F. E. Growth, efficiency, and yield of commercial broilers from 1957, 1978, and 2005. *Poult. Sci.* 93: 2970–2982.

THE ROLE OF MYCORRHIZA IN FOOD SECURITY AND THE CHALLENGE WITH CLIMATE CHANGE

MOINUDDIN¹, FAROOQ A. KHAN² AND WAJID HASAN³

¹Shri Guru Ram Rai University- Dehradun, (U.K.) India

²SKUAST-Kashmir, Srinagar (J&K), India

³Krishi Vigyan Kendra, Jehanabad- Bihar, India

ABSTRACT

Purpose After the fabricated revolution, the accelerating use of fossil energies started to increase the attention of CO₂ in the atmosphere from 280 ppm to the present time of 414 ppm. With the demand for further food products, ferocious chemical inputs and soil civilization practices applied to the soil have increased the quantum of CO₂ released into the atmosphere. adding CO₂ attention to the atmosphere triggers global warming and climate change. In this environment, it's aimed to reduce the effect of climate change by keeping further carbon as a Gomorrah by operating the goods of factory root mechanisms on soil health according to ecological principles. Under long-term field conditions the goods of different soil-factory superintendence, especially mycorrhiza fungi, were delved styles. CO₂ emigrations, photosynthesis, and total carbon and nitrogen insulation and yields are measured regularly. Data are monthly estimated. Results Research findings showed that under field conditions organic toxin and mycorrhizal fungi operations sequestered more carbon. It has been calculated that the use of beast ordure, compost, biochar, and mycorrhizal fungi significantly keeps further carbon. It's determined that there's an increase of 1.5 ppm CO₂ attention in the atmosphere per time. It has been determined that especially long-term addition of organic matter and operation of natural mycorrhizae increase soil organic carbon and consequently soil quality and productivity increase. Conclusions Since the effect of climate change and a high population have negative goods on food security there's a new husbandry disclosure to overcome climate and food security problems. Soil and factory operations must be managed according to low-input ecological principles.

Keywords: Greenhouse Feasts, Climate Changes, Soil Organic Carbon, Food Security, Mycorrhizal operation.

CURRENT SCENARIO OF SUSTAINABLE AGRICULTURE WITH ORGANIC FARMING IN INDIA

MOINUDDIN¹ AND WAJID HASAN²

¹Department of Agronomy, Shri Guru Ram Rai University- Dehradun, (U.K.) India

²Krishi Vigyan Kendra (BAU Sabour), Jehanabad, Bihar, India

ABSTRACT

There is a universal demand for sustainable agriculture, yet agreement and how to progress towards it remain elusive. Sustainability is considered about organic farming—a sector growing rapidly in many countries. There are two vital factors that have attained constant attention in the common people which is Food quality and safety. In the quest for safer food, the demand for organically grown food has increased during the last decades due to their probable health benefit and food safety concerns. Organic food production is defined as a system of cultivation without the application of chemical fertilizers and synthetic pesticides for Genetically Modified Organisms (GMOs), growth hormones and antibiotics. Organic farming works in synchronization with nature rather than against it. India is a country that is bestowed with indigenous skills and potential for growth in organic farming. Although India was far behind in the adoption of organic farming due to several reasons, presently it has achieved rapid growth in organic farming and now become one of the largest organic producers in the world. Therefore, organic farming has a great impact on the health of a nation like India by ensuring sustainable development. The term ‘organic’ was first coined by Northbourne stated that ‘the farm itself should have biological completeness, it must be a living entity, it must be a unit which has within itself a balanced organic life, it is based on minimal use of off-farm inputs and on management practices that restore, maintain and enhance ecological harmony. Recently, the government of India has implemented several programs and schemes for boosting organic farming in the country. Sikkim is the only Indian state to have become fully organic so far.

Keywords: Organic Farming, GMO’s, Antibiotics, Sustainable Development, Food Safety,

EFFECT OF HIGH YIELDING VARIETIES ON MUSTARD CULTIVATION IN ARAJILINE BLOCK OF VARANASI DISTRICT OF UTTAR PRADESH.

RAKESH KUMAR

Department of Agriculture Economics, Udai Pratap College, Varanasi, U.P., India

ABSTRACT

India is the fourth largest oilseed economy in the world. Rapeseed mustard (*Brassica juncea* L.) is the third important oilseed crop in the world after soybean (*Glycine max*) and palm oil (*Elaeisguineensis* Jacq.). The mustard growing areas in India are experiencing the vast diversity in the agroclimatic conditions and different species of rapeseed mustard are grown in some or other part of the country. Mustard is cultivated mostly under temperate climate. The present study is confined to study the cost of cultivation of mustard on farms (marginal, small and large) in Sewapuri Block of Varanasi district of Uttar Pradesh. The study is based on the 30 farms (15 farms from each category) which were selected from three villages of the selected block. The data regarding socioeconomic profile and cost of cultivation were collected from the household. The simple average and percentage were used to get the results of the study. The average holding size were found 0.56 ha. and 1.5 ha. and 2.5 on marginal and small farms and large farms. The cost of cultivation of marginal, small and large farms on different landholding were find out Rs. 18,319.47 (cost A), Rs.50,484 (cost B) and Rs. 65,977 (cost C).

The yield, gross income, farm business income, net income and input-output ratio were found out on an average 16.76 quintal per hectare, Rs. 11,5966.66, Rs. 11,7860, Rs. 113973 per hectare the study showed that as the size of farm is increasing the cost of cultivation is increasing which means large and small farms as compare to marginal farms were using more resources which caused to increased their yield and net income. On the basis of observations this recommendation can be made development of High Yielding varieties with early maturity may be grown under better management condition as pure crop. And, timely and proper inter culture and other management operations be under taken to obtain better results.

EFFECT OF BIOCHAR AND FYM AND ITS INTERACTION ON PHYSICO-CHEMICAL PROPERTIES OF SALT AFFECTED SOIL

ASTHA PANDEY¹, M.S. JAKASANIYA², DEVENDRA INWATI³

¹Banaras Hindu University

²Anand Agricultural University

³Jawaharlal Nehru Vishwa Vidhayalaya

Purpose: Fodder sorghum is important fodder crop in India Sorghum (*Sorghum bicolor* (L.) Moench) belongs to the family Poaceae. Sorghum is a warm- season, short-day annual grass. Locally known as Jowar, it is dual purpose crop cultivated predominantly in the Kharif season. It is a hardy crop tolerant to extreme drought conditions which could be attributed to its deep and extensive root system. Addition of biochar to agriculture soils has been projected as means to improve soil fertility and mitigate climate change. Biomass into biochar can not only result in the renewable energy (synthetic gas and bio-oil), but also decrease the content of CO₂ in the atmosphere, which reveal more research on the effect and behaviour of biochar in soil.

Method: A pot house study was conducted on fodder sorghum at net house of the department of Soil Science and Agricultural Chemistry, B.A.C.A., A.A.U., Anand during *kharif*-2018. The experiment was laid out in completely randomized design (factorial). The treatment comprised four levels of biochar (B₀: 0 t ha⁻¹, B₁: 2.5 t ha⁻¹, B₂: 5.0 t ha⁻¹, B₃: 7.5 t ha⁻¹) and three levels of FYM (F₀: 0 t ha⁻¹, F₁: 5.0 t ha⁻¹, F₂: 10.0 t ha⁻¹) with three replications. A bulk soil for pot study was collected from College of Agriculture, Anand Agricultural University, Vaso.

Result: A pot experiment was conducted during *Kharif* - 2018 in the net house of the Department of Soil Science and Agricultural Chemistry, Anand Agricultural University, Anand to carry out a study on effect of biochar and FYM on yield, chemical composition of fodder sorghum (*Sorghum bicolor* (L.) Moench) and properties of salt affected soil. The soil of experiment was loamy sand having good drainage and pH 8.0 at 0-15 cm soil depth. The experiment was laid out in completely randomized design (factorial). The treatment comprised four levels of biochar (B₁: 0 t ha⁻¹, B₂: 2.5 t ha⁻¹, B₃: 5.0 t ha⁻¹, B₄: 7.5 t ha⁻¹) and three levels of FYM (F₁: 0 t ha⁻¹, F₂: 5.0 t ha⁻¹, F₃: 10.0 t ha⁻¹). Salient findings of the experimental results are summarized as below. The seed germination and plant population at 20, 40 DAS and at harvest influenced significantly by different levels of biochar and FYM. The application of biochar @ 7.5 t ha⁻¹ and 10.0 t ha⁻¹ individually recorded significantly highest seed germination and plant population of fodder sorghum at harvest as compared to control except the effect of application of FYM on plant population at 20 DAS was found non-significant. The interaction effect of different levels of biochar and FYM on seed germination and plant population at 20, 40 DAS and at harvest of fodder sorghum was found non-significant. The application of biochar @ 5.0 t ha⁻¹ gave significantly higher plant height of fodder sorghum at 20 DAS which was at par with higher levels of biochar as compared control. However, the effect of application FYM at different levels was found to be non-significant. In case of plant height at 40 DAS and at harvest i.e., 60 DAS, the application of biochar @ 7.5 t ha⁻¹ and FYM @ 10.0 t ha⁻¹

individually gave significantly highest plant height of fodder sorghum. The plant height increased with increases in application levels of biochar. The interaction effect between different levels of biochar and FYM was found significant with respect to plant height at 20 and 40 DAS. Significantly the higher plant height of fodder sorghum was recorded under the treatment combinations of B₃F₃ and B₄F₃ at 20 and 40 DAS, respectively. The interaction effect of different levels of biochar and FYM on plant height at harvest was found to be non-significant. The application of biochar @ 7.5 t ha⁻¹ produced significantly highest green forage and dry matter yield of fodder sorghum as compared to control. The result depicted that green forage and dry matter yield increased with each increase in levels of biochar. The dry matter yield of sorghum under the application of 7.5 t ha⁻¹, 5.0 t ha⁻¹ and 2.5 t ha⁻¹ was 85.60%, 68.63% and 45.75% higher, respectively over control. Among the treatments FYM, the application of FYM @ 10.0 t ha⁻¹ produced significantly highest green forage yield and dry matter yield of fodder sorghum as compared to control. The dry matter yield of sorghum under the application of FYM @ 10.0 t ha⁻¹ and 5.0 t ha⁻¹ was 10.35% and 8.39% higher respectively over control. The combined application of 7.5 t ha⁻¹ biochar and 5.0 t ha⁻¹ FYM (B₄F₂) produced significantly highest green forage and dry matter yield of fodder sorghum as compared to rest of the treatment combinations. Biochar has failed to draw any impact on nitrogen content and crude protein of fodder sorghum. However, phosphorus and potassium content were affected significantly and maximum content highest phosphorus content was recorded with the application of biochar @ 5.0 t ha⁻¹ whereas significantly higher K content in fodder sorghum was recorded under the application of biochar @ 7.5 t ha⁻¹ over control. The nitrogen, potassium content and crude protein of fodder sorghum affected significantly by different levels of FYM but there was no significant distinction in phosphorus content. The significantly higher nitrogen and potassium content and crude protein content in fodder sorghum was recorded under application of FYM @ 10.0 t ha⁻¹ over control. Effect of interaction between different levels of biochar and FYM was found significant with respect to content of K of fodder sorghum only. The result revealed that application of 5.0 t ha⁻¹ biochar + 10.0 t ha⁻¹ FYM (B₃F₃) and 7.5 t ha⁻¹ biochar + 10.0 t ha⁻¹ FYM (B₄F₃) recorded significantly highest K content in fodder sorghum. The significantly higher uptake N, P and K by fodder sorghum were recorded under the application of biochar @ 7.5 t ha⁻¹ and FYM i.e., 10.0 t ha⁻¹ individually over rest of treatments. Effect of interaction between different levels of biochar and FYM was found significant with respect to K uptake by fodder sorghum only. As per result the treatment receiving application of 7.5 t ha⁻¹ biochar + 10.0 t ha⁻¹ FYM (B₄F₃) gave significantly highest K uptake by sorghum.

Conclusion: Growth and yield parameters like seed germination percentage, plant population, plant height, green forage yield dry matter yield and nutrient uptake were adjudged as ideal parameters to prove the biochar and FYM act as growth promoter. Biochar and FYM have significantly improved agronomic performance by applying them separately or in combination.

IMPACT OF CONSERVATION AGRICULTURE PRACTICES ON GROWTH, YIELD, AND QUALITY OF RICE CROP UNDER RICE-WHEAT CROPPING IN EASTERN INDO-GANGETIC PLAINS OF INDIA

V. KUMAR¹, M. KUMAR¹, S. K. SINGH¹, R. K. JAT², ATUL KUMAR³ AND S. K. CHANDRA¹

¹Dr. Rajendra Prasad Central Agricultural University, Pusa, Samastipur - 848 125, India

²Borlaug Institute for South Asia, Pusa, Samastipur - 848125, India

³Bihar Agricultural University, Sabour, Bhagalpur - 813210, India

ABSTRACT

The long-term experiment was initiated at experimental field of Dr. Rajendra Prasad Central Agricultural University, Pusa, Samastipur, India, since *kharif*, 2006 having 7 combinations of tillage, crop establishment and residue management under rice-wheat cropping system. The crop reported here is rice (cv *Arize 6444*) for *kharif* 2012-13. The experimental site has hot and humid summers and too cold winters and soils belong to order Entisol. The treatment combinations consisted of puddle transplanted rice-conventional tillage wheat (T₁); zero tillage rice-zero tillage wheat on beds (T₂) with residues; zero tillage rice-conventional tillage wheat (T₃) without residues; zero tillage rice-zero tillage wheat (T₄) without residues; zero tillage rice-zero tillage wheat (T₅) with residues; uncuddled transplanted rice-zero tillage wheat (T₆) only rice residues; zero tillage rice with brown manuring-zero tillage wheat (T₇) without residues. Growth attributes like, number of productive tillers & grains per panicle, and 1000 grain weight of rice were the maximum in treatment T₂. Adoption of CA practices increased the grain yield of rice by 0.66-12.05% while, the highest increment (by 12.05%) was noticed in treatment T₇ over conventional practices in T₁. Percentage increase of straw yield under CA practices *viz.*, T₅, T₇, T₄, T₂, T₆ and T₃ was recorded to the tune of 17.06, 16.35, 13.98, 12.63, 9.75 and 1.05%, respectively over conventional practices *i.e.*, T₁ (64.98 q ha⁻¹). Uptake of nutrients followed the yield trend of rice. Total uptake (grain + straw) of N, P, K, Ca, Mg and S by rice was the maximum with zero tillage rice with brown manuring-zero tillage wheat without residues *i.e.*, T₇ (168.92, 37.04, 94.48, 32.97, 6.20 and 28.29 kg ha⁻¹, respectively). Total nitrogen uptake by rice due to treatments, T₅, T₆ and T₇ being at par among themselves and were significantly higher than rest of the treatments. Treatments, T₂, T₄, T₅, T₆ and T₇ improved the yield of rice protein (by 0.68-9.13%) over conventional practices.

Keywords: Conservation agriculture (CA), rice-wheat cropping, nutrient uptake, yields.

SOIL SAMPLING WITH DRONES AND ITS AUGMENTED REALITY IN CLIMATE RESILIENT AGRICULTURE

RAJKISHORE KUMAR AND ATUL KUMAR

Department of Soil Science and Agricultural Chemistry, Bihar Agricultural University, Sabour. Bhagalpur-813210

ABSTRACT

Nowadays, Remote sensing techniques are widely used in precision farming for soil sampling and its augmented reality in climate resilient Agriculture through drones. Thereby, soil sampling is a crucial tool for obtaining data and making informed decisions about field fertilization. The major challenge in agriculture is to reduce the erroneousness in soil sampling and get precise accuracy in representative areas and be able to bring consistency in precision agriculture. The number of vulnerable zones that have been identified in Bihar which have to need to divide into various segment sat the micro level which could be easily manageable

section. The innovative method of determining the location of soil samples automatically is based on a soil map created by drone and directs the user to the generated sample sites. As a result, the primary goal of the various study concluded that agricultural drone with a specific function and the use of unmanned aerial vehicles (UAVs) for a range of tasks in the agricultural sector, including mapping the sector and carrying out a range of analytical analyses, such as growth trends, plant counts, and sizes, creating recipe maps, spotting early signs of plant stress, and gauging zonal effectiveness. The UAV has GPS and is set up to move rapidly and autonomously between different field locations by using GPS way points. It also creates a system that would aid autonomous drones in the agricultural industry and carry out the required analytics along the intended route. It also identifies various scenarios in the agricultural field, which benefits farmers and improves them with daily statistical reports about their farms. It also helps to develop a system that can assist in land analysis and present insights to the operator, which assists farmers and improves them with daily statistics reports by recognizing various scenarios in the agricultural area. A real-time application on UAVs that can easily coordinate with the agriculture sector will be suited for a mapping and analytics method based on drones. Thereby, we concluded that data availability from drones assists the laser scanning and is able to calculate the altitude of the sampling locations and act as a milestone in precision agriculture.

Keywords: Unmanned aerial vehicle, remote sensing and Environmental monitoring

APPLICATION OF ARTIFICIAL NEURAL NETWORKS TO IDENTIFY PESTS AND DISEASES IN AGRICULTURE

JYOTHI V

Department of Plant Pathology, UAS, Bangalore

ABSTRACT

Artificial neural networks are powerful predictive tools that have the ability to detect and approximate non-linear relationships from the data. In an explorative analysis, artificial neural networks were used to predict the geographic distribution of groups of polyphagous plant pests. Using climate variables as predictors, artificial neural network models were compared with binary logistic models for predicting insect distribution. Using bootstrapping, artificial neural networks were shown to predict insect presence and absence significantly better than the binary logistic regression models. Results from the study suggest that artificial neural networks have the potential for application in many areas of plant protection and biosecurity. The most important advantage of artificial neural networks is their ability to detect and approximate non-linear relationships in the data. It is this ability that may enable many complex questions in invasive Biology to be answered, particularly on mechanisms of establishment in plant pests. They have used ANN to identify potential sources of invasive insect species based on their specific species assemblages in a particular region. Clearly, there are opportunities for the application of ANN in many facets of plant protection and biosecurity. The most obvious example is a prediction of plant pest distributions but this could be extended into tools for surveillance, incursion response, and pest management.

ASSESSMENT OF SOIL QUALITY INDICATORS UNDER THE DOMINANT LAND USE SYSTEM OF BIHAR

ATUL KUMAR¹, SHWETA SHAMBHAVI¹, RAJIV RAKSHIT¹, VIJAY KUMAR²,
GOPAL KUMAR¹ AND SHRIMAN KUMAR PATEL¹

¹Department of Soil Science and Agricultural Chemistry, Bihar Agricultural University,
Sabour, Bhagalpur-813210

²Krishi Vigyan Kendra, Manji, Saran, Dr. Rajendra Prasad Central Agricultural
University, Pusa-848125

ABSTRACT

Assessing the quality of the soil is helpful for agricultural production. In this study, 60 soil samples were collected from four distinct land use systems (fallow land, rice-wheat, mango orchard, and vegetable-vegetable) at three soil levels. Soil organic carbon, soil available nitrogen, and soil pH were examined for the four different land use systems. As compared to rice-wheat cropping systems, vegetables cropping, fallow land, and mango orchards have higher soil organic carbon concentrations. The soils of the fallow land use type were more significantly acidic than the soils of the mango orchard, rice-wheat cropping system, and vegetable-vegetable system. In contrast to the rise in soil depth across all land use types, soil organic carbon and accessible nitrogen both showed a decreasing tendency. The pH of the soil did not significantly alter in connection to soil depth in mango orchards, rice-wheat and other land use types. The soil organic carbon content did not differ significantly from one another; however, there were disparities in the soil organic carbon content's varying patterns between land use types and aspects. Under various land use systems, it was observed that the amount of available N, P₂O₅, K₂O, and DTPA extractable micronutrients declined with depth, indicating that the nutrients were retained in the upper layers.

Keywords: Soil quality Indicator, Land use types and Nutrients

INTERACTION EFFECT OF POTASSIUM AND SULFUR ON GROWTH AND YIELD ATTRIBUTING CHARACTERS IN JUTE CROP VAR. JR0524”

VINAY KUMAR, RAJKISHORE KUMAR¹, KUNAL PRATAP SINGH AND
DIWAKAR PASWAN

J.R.S. Katihar

Department of Soil Science and Agricultural Chemistry, Bihar Agricultural
University, Sabour, Bhagalpur-813210

ABSTRACT

The application of sulphur and potassium acts as the best response for the Jute crop. Most farmers usually cultivate jute in poor soil health and with minimum fertilizer application, unable to use the judicious amount of potassium and sulfur fertilizer along with nitrogen and phosphorus. Thereby, deteriorating the yield and quality of fibre crops, as well as its quality. Keeping in this view, a field experiment was carried out entitled “Interaction effect of potassium and sulphur on growth and yield attributing characters in Jute cropmark. JR0524” with RBD design accompanied with 9 treatments and replication thrice. Overall results indicated that there was significant impact of green weight and fiber weight which was a significant influence after advocacy of potassium and sulfur @ 40 kg ha⁻¹ and 30 kg ha⁻¹ respectively. However, the influence of sulphur unable to influence plant height, basal diameter, green weight, and fiber weight of crops. Overall, we recommended that for obtaining the best fiber quality from

farmers ‘fields 40 and 30 kg ha⁻¹. Potassium and sulfur get the highest return and significant improvement in soil health. Meanwhile, the core plot study shows that potassium content positively correlated with other nutrient content like N, P, and S and skewed positively in jute crops. From qualitative point of view, the best quality jute was obtained with higher doses of potassium and sulfur application in soils. The interaction effect between potassium and sulfur was significant regarding productivity, nutrient uptake, and quality improvement of jute crops.

SYNCHRONIZED APPROACH OF MICROBES MEDIATED WITH CHELATED MICRONUTRIENT NUTRIPRIMING TO AUGMENT FE AND ZN CONTENT IN RICE AND LENTIL BASED CROPPING SYSTEM

GOPAL KUMAR^{1*}, PRIYANKA KUMARI², KASTURIKASEN BEURA¹, MAHENDAR KUMAR SINGH¹, SUNIL KUMAR¹, ATUL KUMAR¹ AND AMIT KUMAR PRADHAN¹

¹Department of Soil Science and Agricultural Chemistry

²Bhola Paswan shashtri Agricultural college, Purnea

Bihar Agricultural University, Sabour-813210, Bhagalpur (India)

ABSTRACT

In plants, Fe and Zn are essential to several biological processes once they are required for key metabolic reactions and biological functions. Currently, the biofortification of crops like Cereals with micronutrients such as iron (Fe) and zinc (Zn) is extremely important due to the deficiencies of these micronutrients in the human diet and in soils. Biofortification is a bouquet of approaches that focus on improving the availability of micronutrients biologically in staple food products like wheat, maize, pearl millet, rice, and others. Zinc and Fe deficiency is a predominant micronutrient disorder in crop plants and humans worldwide, adversely impacting crop productivity and human health. Seed reserves of micronutrients are considered as ‘starter fertilizer’ and vital under soil conditions with their low supply, as well as under stress conditions such as drought stress. There are several options for enriching seeds with Fe and Zn. Seed treatment with Fe/Zn by priming or coating has been suggested as useful and cost-effective option for increasing seed Zn concentration. Seeds enriched with zinc (Zn) and Fe are usually associated with better germination, more vigorous seedlings and higher yields with better content in edible parts. Taxonomically, the soils of the study area fall in the order “*Inceptisols*” and sub group “*Typic Ustifluvents*” (Soil Management Support Services 1985). These soils are alkaline in reaction. Seed priming with 2 mg L⁻¹ Fe + 2 mg L⁻¹ Zn has been shown to be non-cytotoxic, ensuring a high rate of germination (80%) improves the stand establishment, as well as improving tillering, grain yield and micronutrient Fe and Zn grain contents in most cases. The use of microorganisms to help the crop plant in more efficient and effective uptake and translocation of Zn and Fe is a promising option that needs to be effectively integrated into agronomic or breeding approaches. This work revealed that seed priming with Fe and Zn micronutrients with microbes mediated constitutes a useful and alternative approach for the agronomic biofortification of Rice and Lentil based cropping system.

ROLE OF INDIGENOUS TECHNICAL KNOWLEDGE (ITK) IN THE PRESENT DAY

PANKAJ YADAV¹ AND NEELAM KUMARI²

¹Department of Horticulture; Maharana Pratap Horticultural University Karanal

²Department of Extension Education; CCS Haryana Agricultural University, Hisar

ABSTRACT

Indigenous Technical Knowledge (ITK) has immense potential for innovation, especially at the grassroots level. India is a country populated by a number of indigenous communities, most of which have their own set of unique traditional knowledge and technology base. Many of these knowledge and technologies are at par with the modern knowledge and technology system and have been provided the indigenous communities with comfort and self-sufficiency. The central attention of the research is to examine rural women’s awareness on Indigenous Technical Knowledge (ITK). The poor farm women were using ITKs as easy and low-cost options. Though many of them are not aware about sustainable agriculture, they use ITKs to make the best utilization of their resources and capabilities Indigenous knowledge systems (IKS) comprises knowledge developed within indigenous societies, independent of, and prior to, the advent of the modern scientific knowledge system (MSKS). Indigenous knowledge (IK) covers diverse areas of importance for society, spanning issues concerned with the quality of life - from agriculture and water to health.

Keywords: Indigenous Technical Knowledge, Tribal community, Empowerment

DETECTION OF POMEGRANATE LEAF DISEASE USING MULTICLASS ROBUST ENERGY BASED LEAST SQUARES TWIN SUPPORT VECTOR MACHINE (RELS-TSVM) CLASSIFIER

RIYAJ UDDIN KHAN, SHAIK RAFI AHAMED, M K BHUYAN

Department of Electronics and Electrical Engineering, Indian Institute of Technology Guwahati, India-781039

ABSTRACT

This research aims to automatically detect diseases that affect pomegranates, as it is very tedious to identify plant diseases manually. Plant disease symptoms are commonly observed in the leaves, the most visible part of a plant. Therefore, leaf images have been used as a tool by researchers for automatically detecting and classifying plant diseases. A database of 725 images in RGB format is collected from the internet with five different class labels, Alternaria Alternata, Bacterial Blight, Anthracnose, Cercospora Leaf Spot, and Healthy Leaf. In the first step, prepossessing removes the image's noise by clipping unwanted image portions, applying a smoothing filter to smooth the images, and increasing the image contrast by enhancement. For extracting the features, the images are first converted from RGB format to grayscale. The Gray Level Co-occurrence Matrix (GLCM) is formed, and features such as contrast, energy, correlation, homogeneity, orientation, entropy, eccentricity, minor axis length, and major axis length are evaluated. Principal component analysis (PCA) is applied to get the best features and reduce the dimensionality. A multiclass robust energy-based least squares twin support vector machine (RELS-TSVM) is used to calculate the classification accuracy from the best-selected features. Results are validated using 10-fold cross-validation. The experimental results of our proposed method obtained an accuracy of 96.5% for the given database. Thus, compared to some of the existing methods in the literature, our method exhibits better classification accuracy and less processing time.

Keywords: Plant diseases, Pomegranate, Image processing, Principal component analysis (PCA), Robust energy-based least squares twin support vector machine (RELS-TSVM), Gray Level Co-occurrence Matrix (GLCM).

EFFECT OF ORGANIC PRODUCTS ON HUMAN HEALTH

SHAKSHI DUBEY AND MOINUDDIN

Department of Agronomy, School of Agricultural Sciences

Shri Guru Ram Rai University Dehradun- 248001, Uttarakhand, India

ABSTRACT

Organic products are chemical free and grown without using pesticides or chemical fertilizers. Organic products are sustainable and eco-friendly in nature, It enhance and sustains biological diversity within the system. Organic food products have become increasingly popular over the past years, since people become more aware about the organic farming. It helps to prevent from many diseases and increases metabolic activities because it has higher nutritional values than chemical rich products. Organic products has anti mutagenic effect as they contained higher amount of vitamins (A, C & E), minerals (potassium, phosphorus, nitrate) and antioxidants like flavonoids, carotenoids and phenolic acid and also has anticancer effect as well. Due to high amount of fiber it helps to reduce the risk of allergic diseases and overweight or obesity in humans. Organic products help in growth process of children and boost their immune system. Organically grown foods develop the capacity to produce more antioxidants than inorganically grown food. It helps to fight against insect and fungal attacks. The main aim of organic products is to minimal use of off-farm inputs, or maintains the health and productivity of interdependent communities of soil life, plants, animals and people. Organic products are the best for human health and the best for the nature.

Keywords: Organic food, Obesity, Anticancer, Human health, Nature

ASSESSMENT OF SOIL QUALITY OF DIFFERENT LAND USE SYSTEMS IN SOUTHERN TRANSECT OF BENGALURU

**ALTAF KUNTOJI¹, SUBBARAYAPPA C. T.,² SATHISH A.,³ RAMAMURTHY V.⁴
AND MALLESHA B. C.⁵**

^{1,2,3}Department of Soil Science and Agricultural Chemistry

⁴National bureau of soil survey and land use planning, Hebbal Bengaluru.

⁵Department of Agricultural Microbiology. UAS, GKVK Bengaluru- 65 Karnataka.

ABSTRACT

Intensification of agriculture through the use of mineral fertilisers, irrigation with waste water and urbanisation would all have a negative impact on the soil properties with this our objective was to identify the most appropriate soil quality indicators and to evaluate the impact of the four most prevalent land use types on soil quality of southern transect of Bengaluru. Principal component analysis (PCA) was performed to get the minimum data set which best represents soil quality. Fifty soil samples were collected from each land use system viz agriculture, horticulture, mulberry and plantation lands. The soil was examined for sand, silt, clay, soil pH, organic carbon (OC), electrical conductivity (EC), available nitrogen (N), phosphorus (P), potassium (K), exchangeable calcium (Ca), magnesium (Mg), sulphur (S), micronutrients (Zn, Fe, Mn, Cu, B) and dehydrogenase activity (DHA). The PCA was performed which screened out the five principal components (PCs) with eigenvalue >1. Based on rotated factor loadings of soil attributes: OC, pH, Mg, P₂O₅, Zn and clay were selected as the most appropriate key indicators of soil quality. These selected indicators were converted into scores by linear scoring method and soil quality index was worked out. Agricultural land had the greatest soil quality index (0.60) among the various land-use systems, followed by horticulture (0.56), mulberry (0.53), and plantation land had the lowest (0.50). Conclusively, all the land-use systems of southern transect of Bengaluru fall under the medium category of soil quality (0.50-0.75).

Keywords: Soil quality, minimum data set, southern transect of Bengaluru and land use systems

DISTRIBUTION AND ABUNDANCE OF *PROSOPIS JULIFLORA* (SWARTZ) DC. IN COIMBATORE, TAMIL NADU

MONIKA SINGH ^{A*}, AND RAJASEKARAN ARUNACHALAM ^A

^a Forest Ecology and Climate Change Division, Institute of Forest Genetics and Tree Breeding, Coimbatore 641002, India

ABSTRACT

Climate change and globalization have increased the rates of invasive species establishment. *Prosopis juliflora* (Swartz) DC, evergreen, multipurpose tree/ shrub native to South America and the Caribbean is one of the world's 100 most dominant invasive species and is of great concern among the invasive alien plants identified in India. It has had serious repercussions on the native biodiversity, with whom it competes for resources, and also affects the nesting success of birds. With its thorniness and shrub habit, it quickly invades open areas and paths, forming impenetrable dense bushes. *P. juliflora* typically initiates its invasion by the transportation of seeds along water bodies and through animal dispersal, replacing endemic riverine plant communities. The study was conducted to assess the distribution pattern and abundance of *P. juliflora* along roads and river in Coimbatore district using Epicollect mobile application. The distribution pattern of the *P. juliflora* revealed larger number of invasion along major roads compared to the minor ones where infestation was less visible. It aggressively invaded roadside and wastelands. Robust individuals of the plant were found near water bodies. Moreover, it was observed that *P. juliflora* is fastly moving to agricultural lands and activities like construction of roads and factories are helping in promoting its further spread.

Findings of this study will help in prioritizing the pathways for *Prosopis* prevention, implement effective surveillance to ensure early detection and rapid eradication measures for new introductions, apply eradication measures to species, which are at an early stage of invasion, and apply management measures to those populations which are already widely spread in the district. Therefore, it is suggested that a timely decision should be taken to control this invasive species where it is still present in small patches.

Keywords: Invasive plant species, *P. juliflora*, Climate change, Invasion, Distribution

ASSESSMENT OF GENETIC VARIABILITY, HERITABILITY AND GENETIC ADVANCE IN COWPEA [*Vigna unguiculata* (L.)] Genotypes

CHAITRA¹, HASAN KHAN^{*}, B.V. TEMBHURNE, B. SUVARNA AND A. AMAREGOUDA

Department of Genetics and Plant Breeding, College of Agriculture, Raichur
University of Agricultural, Sciences, Raichur, Karnataka, India

ABSTRACT

The investigation was conducted during *kharif* 2021 using 25 genotypes of cowpea along with six checks in randomized complete block design of three replications with three different dates of sowing. The estimates of phenotypic and genotypic variances revealed that, phenotypic coefficient of variation was greater than the genotypic coefficient of variation for all the characters for present study. The high phenotypic and genotypic coefficient of variation was observed for traits *viz.*, number of secondary branches per plant, number of pods per plant, seed yield per plant, seed yield per plot and seed yield per hectare, while lowest PCV and GCV was observed for days to first flowering, days to 50 per cent flowering, pod length and days to physiological maturity. Higher heritability estimates coupled with high genetic advance as per cent of mean were observed for number of primary branches per plant, number of secondary

branches per plant, number of pods per plant, test weight, seed yield per plant, seed yield per plot, seed yield per hectare, dry matter content (g/plant), chlorophyll content (SPAD) and harvest index (%). It indicates additive gene action and made it suitable for direct selection. Hence, selection based on these characters would be rewarding for further improvement of cowpea.

Keywords: Cowpea, PCV, GCV, heritability, genetic advance

STUDIES ON ASSOCIATION SHIP BETWEEN SEED YIELD AND ITS ATTRIBUTING TRAITS IN COWPEA [*VIGNA UNGUICULATA* (L.)] GENOTYPES

CHAITRA¹, HASAN KHAN*, B.V. TEMBHURNE, B. SUVARNA AND A. AMAREGOUDA

**Department of Genetics and Plant Breeding, College of Agriculture, Raichur
University of Agricultural, Sciences, Raichur, Karnataka, India**

ABSTRACT

A field experiment was conducted during *kharif* season 2021 to estimate the correlations and path coefficients for sixteen quantitative characters among 25 cowpea genotypes including six checks with randomised complete block design of three replications at three dates of sowing. Seed yield per plant had positive significant correlation with number of primary branches per plant, number of seeds per pod, number of pods per plant, pod length, test weight and harvest index at phenotypic level. At genotypic level seed yield per plant had positive significant correlation with plant height, number of primary branches per plant, number of seeds per pod, number of pods per plant, pod length, test weight and harvest index. Path coefficient analysis revealed number of pods per plant and test weight had high direct positive effect on seed yield per plant at phenotypic level. Number of secondary branches per plant, number of seeds per pod, pods per plant, days to physiological maturity, dry matter content and test weight had high positive direct effects on seed yield per plant at genotypic level. Correlation and path analysis indicated that for increasing seed yield in cowpea direct selection should be carried out for higher values of number of seeds per pod, number of pods per plant and test weight.

Keywords: Correlations, Cowpea, Path analysis, direct effect

ANALYTICAL STUDY OF URBAN GREEN SPACES THEIR ROLE TO IMPROVE URBAN MICROCLIMATE USING LANDSAT 8 OLI AND TIRS DATA THROUGH ASSESSMENT OF LAND SURFACE TEMPERATURE RELATION WITH NORMALIZED SATELLITE INDICES AND ESTIMATION OF SPATIO-TEMPORAL TRENDS IN TEMPERATURE AMONG VARIOUS LAND USE LAND COVER CLASSES OF MUMBAI CITY

PRIYANKA SS, A. RAJASEKARAN AND P. AMALADAS

Organization-Institute of Forest Genetics and Tree Breeding, FRI, ICFRE, Coimbatore.

ABSTRACT

Urban heat island (UHI) is an extremely perceptible problem in urban areas and need to address immediately for sustainable urban development. Trees and vegetation play vital role to mitigate UHI effects and ultimately to improve urban microclimate. Megacities like Mumbai, has tremendous pressure of accommodating huge population in relatively small landmass. Several times, urban green spaces are sacrificed for development of grey structures leading to depletion of urban green spaces significantly. These factors altogether hamper environmental harmony of city and alters the microclimate significantly. UHI is indeed an inevitable product of such

activities. The city has lost its green cover very rapidly from past few decades and the process is an ongoing venture. Therefore, this study attempts to assess the relationship of estimated land surface temperature (LST) with normalized difference vegetation index (NDVI) for Mumbai city in India using Landsat 5 and 8 data for two decades (1999-2019). The study also classifies different land use/land cover (LULC) types using maximum likelihood classifier, and analyses the relationship built by LST with the green areas and built-up area along with other land use land cover classes. Green spaces area within the City of Mumbai assessed through Land use/land cover, LST and NDVI maps of three different years are generated from Landsat 5 TM and Landsat 8 OLI images of the year 1999, 2009 and 2019 respectively. Nine major land cover classes are considered for this study such as Vegetation, Mangroves, Water body, Built-up, Wasteland, Beach, Agriculture, Playground, and Mudflats. A mono-window algorithm is used to generate the LST maps. Landsat 5 TM and Landsat 8 OLI images are also used to generate the NDVI maps. Results from this study have shown that there are significant land use changes within the study area.

Although the conversion of natural green areas into residential and commercial areas significantly increases the LST, matured trees in urban green space will help to mitigate the effects of UHI and it is important to sustain urban development as well as to provide better quality of life on the urban population. Pearson's correlation coefficient analysis was applied to find relationship between different urban green areas and respective land surface temperature to assess the microclimate amelioration by urban green spaces of Mumbai city. Results revealed high negative correlation between urban green areas and land surface temperature while grey structures i.e. built up areas showed positive correlation with land surface temperature.

Keywords: LULC, UHI, LST, NDVI, Supervised Classification, Maximum Likelihood Classifier

KNOWLEDGE, PERCEPTION, AND SATISFACTION OF PADDY FARMERS ON THE USE OF INFORMATION AND COMMUNICATION TECHNOLOGY (ICT) TOOLS IN JHAPA, NEPAL

**U.P. SIGDEL, K.N. PYAKURYAL, D. DEVKOTA³, G. P. OJHA
AGRICULTURE AND FORESTRY UNIVERSITY, RAMPUR, CHITWANJ**

ABSTRACT

ICT technologies including radio, television, mobile phones, the internet, and computers are gaining traction in Nepal's discourse on the growth of the agriculture sector. ICT solutions for farm extension fill the gap left by conventional agriculture extension. The purpose of this study was to evaluate the knowledge, perception, and happiness of paddy farmers in Jhapa about ICT technologies. The study was conducted using a multistage purposive sampling procedure with a survey research design. Randomly chosen 130 sample respondents were interviewed using a semi-structured interview schedule that had been pretested. The data analysis included descriptive statistics as well as appropriate scaling techniques. The results showed that the majority of the respondents were male (80.9%) with an average age of 47.27yrs. The study further reveals that only 5.4% were illiterate while the same respondents were not involved in any type of organization. Regarding the sources of information of the respondents, it was found that they were frequently in contact with personal localities (0.73) followed by mass media (0.30) and personal cosmopolite (0,27). Respondents were somewhat aware (0.45) of the important functions of ICT technologies. In terms of ICT tools, respondents mostly own TV (0.94), Radio (0.95), and mobile phones (0.70) but have higher knowledge of radio (0.92), television (0.89), and mobile phones (0.68). Similar to how radio and television were the main

ICT tools utilized for agricultural information. While utilizing the radio and television for information, respondents did well, they struggled with using other tools regarding the skills they possess (0.27). The usage of ICT tools was restricted to radio, television, and mobile phones, yet the majority of respondents perceived them positively (0.27) and were moderately satisfied with their usage of the ICT tools (0.26). Therefore, utilizing a variety of ICT tools should be viewed as a key strategy for creating a more effective extension system. Farmers would be encouraged to employ additional ICT technologies if more pertinent policies were created.

Keywords: Knowledge, Perception, Satisfaction, ICT, Agriculture

CYANOBACTERIA AS A BIOREACTOR FOR THE AgNPs Synthesis And Their Applications

SHAHEEN HUSAIN

AINT Amity University Uttar Pradesh, Noida, 201303

ABSTRACT

The green synthesis of metallic nanoparticles has paved the way for improving and protecting the environment by decreasing the use of toxic chemicals and eliminating biological risks in biomedical applications. Biological synthesis of metal nanoparticles is gaining more importance due to simplicity, rapid rate of synthesis and eco-friendliness. Biosynthesis of silver nanoparticles (AgNPs) using cyanobacterial aqueous extract as the reducing and capping agent for AgNPs synthesis. The synthesized nanoparticles were characterized by UV-VIS spectrum, SEM, EDS, TEM, AFM, DLS and XRD. Obtained nanoparticles were polycrystalline in nature and synthesized AgNPs with surface plasmon significant band in the size range of 6-45nm with average 30 size nm. FT-IR study revealed the role of secondary metabolites present in aqueous extract for the synthesis of AgNPs. Biological activities of purified AgNPs as antioxidant and antibacterial potential showed the highest antibacterial activity against *Staphylococcus aureus* MTCC 902.

Keywords: Cyanobacteria, AgNPs, Biological synthesis, Antioxidant, Antibacterial

ESTIMATION OF VARIABILITY AND ASSOCIATION PARAMETERS IN F₂ GENERATION OF THE CROSS GKVK16×ICGV91114 IN GROUNDNUT (*Arachis hypogaea* L.) For yield and Water Use Efficiency related traits

H. C. Sowmya, D. L. Savithamma and H. C. Latha

College of Agriculture, Kalaburagi-585 103, Karnataka

Purpose

Groundnut is one of the important edible oilseed crops of the world and also in India. Recent climatic change has lead to low productivity of the crop. In order to cope up with changing climate conditions, there is a need to develop climate resilient genotypes especially drought tolerant genotypes. In order to identify drought tolerant genotypes, estimation of Water Use Efficiency through its related traits is one of the ways. Variability and association study is required to know the variability existing for different traits in the segregation generation and for further selection and to develop water use efficient genotypes.

Methods

The F₂ generation of the cross GKVK16×ICGV91114 and their parents were planted in 20 m² plots with a spacing of 40 cm × 30 cm. Observations were recorded on individual plants of F₂ generation for days to first flowering, plant height, primary branches per plant, SCMR, SLA,

Pods per plant, pod yield per plant, kernel yield per plant, Shelling *per cent* and SMK *per cent*. Variability and Correlation analysis was carried out in F₂ generation using the recorded data.

Results

High GCV, PCV and heritability values were recorded for pods/plant, pod yield/plant, kernel yield/plant and SMK and less variability for SLA and SCMR. There is high heritability for almost all the traits except plant height and primary branches per plant. High significant positive correlation was seen for primary branches per plant, SCMR, pods/plant and kernel yield/plant with Pod yield/plant. Non significant negative association was observed for SLA with Pod yield/plant.

Conclusions

Sufficient amount of variability exists for yield related traits but not for WUE related traits in the F₂ generation of the cross GKVK16×ICGV91114 and further selection will be effective based on yield related traits but not on WUE related traits.

Keywords: Climate resilient, PCV, GCV, Heritability, Correlation, SLA, SCMR

ASSESSMENT OF VARIABILITY AND ASSOCIATION IN F₂ SEGREGATING GENERATION OF THE CROSS GKVK13×KCG2 IN GROUNDNUT (*Arachis hypogaea* L.) FOR YIELD AND WATER USE EFFICIENCY RELATED TRAITS

H. C. SOWMYA, D. L. SAVITHRAMMA AND H. C. LATHA

College of Agriculture, Kalaburagi-585 103, Karnataka

Purpose

For effective selection of high yielding genotypes knowledge on genetic parameters such as genetic variability, heritability, genetic advance is essential. Genetic variability studies for yield and WUE related traits are very important for selecting climate resilient genotypes in the present context of climate change. In order to identify drought tolerant genotypes, estimation of Water Use Efficiency through its related traits like SCMR and SLA is simple method. Variability and association study is required to know the variability existing for different traits in the segregation generation and for further selection and to develop water use efficient genotypes.

Methods

The F₂ generation of the cross GKVK13×KCG2 and their parents were planted with a spacing of 40 cm × 30 cm. Observations were recorded on individual plants of F₂ generation for days to first flowering, plant height, primary branches per plant, SCMR, SLA, pods per plant, pod yield per plant, kernel yield per plant, Shelling *per cent* and SMK *per cent*. Variability and Correlation analysis was carried out in F₂ generation using the recorded data.

Results

High GCV and PCV values were recorded for plant height, primary branches per plant, SLA, pods/plant, pod yield/plant, kernel yield/plant, shelling per cent and SMK. High heritability was recorded for all the traits. High significant positive correlation was seen for plant height, primary branches per plant, pods/plant and kernel yield/plant with pod yield/plant. Non-significant negative association was observed for SCMR and negative significant for SLA with Pod yield/plant.

Conclusions

Large amount of variability exists for both yield and WUE related traits in the F₂ generation of the cross GKVK13×KCG2 and further selection will be effective based on yield and WUE related traits to develop high yielding and drought tolerant genotypes.

Keywords: Climate change, PCV, GCV, Heritability, Correlation, SLA, SCMR

EXPLORING THE DYNAMICS OF VIRUS-VECTOR RELATIONSHIP AND GENETIC DIVERSITY OF BEGOMOVIRUS AND WHITEFLY, *Bemisia tabaci* (Gennadius), POPULATIONS OF INDIA

ARCHANA ANOKHE^{1*}., S. SUBRAMANIAN¹., PREETI RAMTEKE².,

¹IACR- Indian Agricultural Research Institute, New Delhi-110012

² Department of Zoology., Kamla Devi Mahila Maha Vidyalaya, Chhattisgarh-491441

ABSTRACT

Whitefly, *Bemisia tabaci* (G) is a pest of several agricultural and horticultural cropping system. It causes damage directly as a sucking pest and indirectly as a vector of multiple genera of viruses specifically, belonging to genus begomoviruses. The estimated annual economic damage by whitefly is 2 billion dollars worldwide. *B. tabaci* have been considered as a species complex comprising of at least 36 morphologically indistinguishable genetic groups and in India as many as nine genetic groups are present. Asia-I and Asia II-1 are the two predominant genetic groups of *B. tabaci* distributed widely in different agro-climatic zones of India.

The present investigation focuses on the virus-vector interaction and role of metabolic important enzyme in virus transmission. The population for study was collected from Sri Ganganagar, Delhi and Coimbatore from the host tomato, brinjal and cotton. The Isogenic line was generated from single female of each population on respective host. Genetic group of *B. tabaci* populations under study was identified and transmission as well as biochemical characterization of four metabolically important enzyme *i.e* Alkaline phosphatase (ALP), Lipase, Carboxyl esterase and cytochrome

From the study it was found that Sri Ganganagar and Delhi population belongs to Asia II-1 genotype whereas Coimbatore populations belongs to Asia-I genotype. Bayesian Phylogenetic analysis revealed that both the genotype shows genetic divergence with each other. From the transmission study it was observed that rate of *Tomato leaf curl new Delhi Virus* transmission is significantly higher in tomato reared Asia II-1 genotype as compare to Asia I. The minimum acquisition and inoculation access periods ranges from 5 to 15 minutes for both the genotypes. From the study of metabolically and xenobiotic enzyme characterization it was revealed that tomato reared Sri Ganganagar female has shown 0.47 $\mu\text{mol/ml/mg}$, 4.71 $\mu\text{mol/ml/mg}$, 19.62 $\mu\text{mol/ml/mg}$, 215 nmol/ml/mg Alkaline Phosphatase (ALP), Lipase, Esterase and Cytochrome P- 450 activity which is significantly higher to Delhi *i.e* 0.36, 3.26 $\mu\text{mol/ml/mg}$, 15.16 $\mu\text{mol/ml/mg}$, 158 nmol/ml/mg and to Coimbatore population where it was recorded 0.29 $\mu\text{mol/ml/mg}$, 2.48 $\mu\text{mol/ml/mg}$, 9.89 $\mu\text{mol/ml/mg}$, 109 nmol/ml/mg respectively. When enzyme activity of viruliferous, aviruliferous and pesticide exposed population was compared, it was found that ALP and Lipase was increased significantly in viruliferous population whereas esterase was increased significantly in Insecticide exposed population which indicate that former play important role in shaping the virus-vector relationship whereas later enzyme play important role in xenobiotic detoxification.

Keywords- *Bemisia tabaci*, Begomovirus, Enzymes,

**SURVEY, IDENTIFICATION AND SELECTION OF BUD MUTATION IN APPLE
(*Malus x domestica* Borkh.) IN HIMACHAL PRADESH (INDIA)**

**HEERENDRA PRASAD*, K KUMAR, DINESH SINGH THAKUR, JAYESH GARG,
VAIVABH CHITTORA, ARCHANA SHARMA**

**Dr Y S Parmar University of Horticulture and Forestry, Nauni, Solan Himachal Pradesh
ABSTRACT**

Spontaneous mutation identification in fruit crops is a superior advance and short cycle method in fruit breeding programmes. The present investigation entitled “Survey and identification of spontaneous mutation origin in apple (*Malus x domestica* Borkh) to identify the spontaneous mutation in apple in growing belts. For spontaneous mutation, field surveys were carried out in existing apple plantations located in districts of Shimla, Kullu, Kinnaur and Lahaul & Spiti in Himachal Pradesh. Based upon pre-selection criteria such as bearing habit, time of colour development and time of fruit maturation, screening of bearing apple trees was done. Feedback information was also collected from the orchardists/grower and the identified trees were marked for systematic evaluation studies. In all, 10 bud sports were identified. Two of them were early colouring (Shimla 1 in cv. Red Delicious and Shimla 2 in cv. Vance Delicious) in which colour development started 4-6 weeks earlier than in their mother trees. As many as five bud sports were identified for developing solid colour patterns (washed out) over the entire fruit surface as against streaked patterns of colour in the fruits of their mother trees. There were namely Kullu, Kullu 1, Kullu 2, Manikaran 5 and Kalpa 2. One bud sport Kalpa 1 discovered was unique being late in fruit skin development as compared to fully red coloured fruits on its mother tree. The other two bud sports (Tabo 1 and Kalpa 3) were spur-type as against standard mother trees of cv. Starking Delicious and cv. Red Delicious in districts of Lahaul & Spiti and Kinnaur, respectively.

Keywords: Apple Bud Sports, Kullu 2, Kalpa 1, Spontaneous mutation, Tabo 1

**USE OF GEOSPATIAL TOOLS FOR MAPPING OF GEOGRAPHICAL
INDICATORS OF AGRICULTURE IN HIMACHAL PRADESH**

AASHIMA SHARMA*, SOMDEV SHARMA, AND VIKAS KUMAR SHARMA

**Department of Fruit Science, College of Horticulture and Forestry (Dr. Yashwant Singh
Parmar University of Horticulture and Forestry), Neri, Hamirpur, H.P. 177001, India**

ABSTRACT

Geographical Indication of Goods (GI) as the name implies, is an indication, in the form of name or sign, used on the goods that have a specific geographical origin and poses qualities or a reputation that are due to the place of origin. In order to function as a GI, a sign must identify a product as originating in a given place. In addition, the qualities, characteristics or reputation of the product should be essentially due to the place of origin. Since the qualities depend on the geographical place of production, there is a clear link between the product and its original place of production. A geographical indication right enables those who have the right to use the indication to prevent its use by a third party whose product does not conform to the applicable standards. According to the definition of geographical indication, the geographic information should be included as one of the defining elements. In that case, geographical indications for agricultural products are considered as geographical features which can be modeled using spatial models to illustrate their distribution and variations in space. The spatial distribution of Agriculture Geographical Indications (AGIs) can be linked with the driving forces thus revealing scientific evidence for agricultural heritage protection, development and international trade trends of agricultural products and their future projections. Thus, the spatial analysis of AGIs plays an important role in supporting the agricultural sector to make decisions about AGIs protections.

Keywords: Geographical Indication, spatial analysis

NANOFERTILIZERS: THEIR EFFECT ON CROP PRODUCTION AND SOIL HEALTH

ANKITA SHARMA* SWAPANA SEPEHYA, ANIL KUMAR AND RAKESH SHARMA

**Department of Soil Science and Water Management, College of Horticulture & Forestry
(Dr. YS Parmar University of Horticulture & Forestry), Neri, Hamirpur, H.P. 171001**

ABSTRACT

Global agriculture faces a tremendous problem in meeting the food demands of a fast-growing population. According to estimates, current crop production will need to be increased by up to 70 per cent to meet future food demands. Conventional fertilizers and pesticides are not sustainable for a variety of reasons, including inefficient delivery and consumption, expensive energy and water inputs, and negative effects on the soil health. As a result, there is an increasing awareness of the benefits of using environmentally friendly, long-term fertilizers that focus on measures on soil health conservation. Nanotechnology has the ability to completely transform the agriculture sector. The application of nanotechnology in form of nanofertilizer gives a creative, efficient, and eco-friendly alternative to conventional fertilizers. Nanofertilizers are nutrient transporters with nanoscale dimensions ranging from 30 to 40 nanometers that can retain a large number of nutrient ions due to their large surface area and release them continuously and slowly in proportion to the crop's needs. Because of their particular characteristics, they are employed in lesser doses and have been shown to boost crop yield. They've also been shown to aid in the nitrogen cycle, enzymatic activity, and the induction of plant-beneficial microorganisms in soil. The prospective use of nanofertilizers will undoubtedly spark a revolt inside the fertilizer industry, addressing the issue of food insecurity in underdeveloped countries. This study demonstrates the potential use of nanofertilizers in agriculture for increased plant performance and productivity without degrading the soil.

Keywords: Nanofertilizers, Crop production, Soil health

DEFENSE MECHANISM OF HONEYBEES AGAINST DISEASES AND ENEMIES

BABITA KAUSHAL AND HEERENDRA PRASAD

**Department of Entomology, Dr. Y.S. Parmar University of Horticulture and Forestry,
Nauni, Solan-173230 (HP)**

ABSTRACT

Bees are important pollinators, and their widespread decline has prompted serious implications about ecosystem sustainability and food production. Parasites and pathogens of bees can affect the foraging behaviour, learning ability and memory of their hosts. Honeybees counter with various viral, bacterial and fungal diseases during their life time. Pests like varroa, wax moth, wasps and hornets have been a menace to the health of a bee colony. Bees have developed a variety of defence mechanisms to counteract these impacts on an individual and collective level. At individual level, bees respond to pathogen infection by isolating themselves from their colony, cleaning and grooming and eliminating the diseased brood from the colony (Hygienic behaviour). It has been shown to be effective against American foulbrood, Nosema, Chalkbrood, Sac-brood and paralysis and also involved in resistance to Varroa mites in European bees. Bees also have an ability to self-medicate, where they collect resins from trees having anti-biotic properties. At social level, bees unite together to defend their colony. Swarming is one of the major examples of colony defence. It involves building new wax combs after bees' swarm from their old colony. This appears to be a predominant strategy

of Africanized honey bees, which not only swarm, but also abscond from their nests. This strategy ensures that if larvae are diseased, adults are not and vice versa. Another method adopted by bees is the quick regeneration of population which alters the life-cycle of a tracheal mite as continuous rotation of bee generations is taking place. Apart from the diseases, honeybees also have adopted unique tactics to scare off predators like hornets by showing shimmering patterns, stinging or killing by trapping them inside a thermal ball at 47°C. Another interesting social behaviour is when the queen mates with several drones (polyandry) to generate great genetic diversity within the colony which ultimately makes them much more resistant to infectious diseases. On the cellular level, bees also have an innate immune defence against pathogens. Several pathways inside a bee's body are activated upon infection by bacteria or viruses. Resistance to infections can be aided by cellular defence mechanisms (hemocytes) and humoral reactions (enzyme and anti-microbial factors). The medical treatment of a colony might interfere with the natural defence mechanisms especially the use of antibiotics. Hence it is important to encourage the natural methods over chemical use.

Keywords: Bees, pest, diseases, ecosystem, defence mechanism

ASSESSMENT OF SOIL BIOLOGICAL PROPERTIES UNDER DIFFERENT LAND USES IN BAROG-DHILLON WATERSHED IN SOLAN DISTRICT OF HIMACHAL PRADESH

DINESH KUMAR* AND RAJEEV DHIMAN

Department of Silviculture and Agroforestry, Dr. Y. S. Parmar University of Horticulture and Forestry Nauni, Solan-173 230 (H.P.)

ABSTRACT

The present investigation entitled “Assessment of soil biological properties under different land uses in Barog-Dhillon watershed in Solan district of Himachal Pradesh” was carried out with a view to ascertain the biological properties of soils under different land uses viz. agriculture land, forest land, grassland and scrub land under project area and non-project area of Barog-Dhillon watershed. On the basis of detailed survey and random sampling, representative soil samples from two depths i.e., 0-15cm and 15-30cm were collected. The Bacterial count (310.56 and 155.56 cfu g⁻¹), fungal count (3.57 and 1.78 cfu g⁻¹), and actinomycetes count (15.81 and 8.43 cfu g⁻¹) recorded higher in surface and subsurface soils under forest land and lowest under scrub land soils, respectively. Whereas, in case of conditions, bacterial count (271.62 and 136.01 cfu g⁻¹), fungal count (3.73 and 1.86 cfu g⁻¹) and actinomycetes count (12.52 and 6.73 cfu g⁻¹) recorded higher in surface and subsurface soils under watershed project area compared to non-project area of watershed. It was concluded that biological properties assessed for different land uses were found higher in case of watershed project area as compared to non-watershed project area.

Keywords: Land Uses, Soil Biological Properties, Watershed

RESPONSE OF FOLIAR SPRAY OF IRON IN STRAWBERRY (*FRAGARIA* × *ANANASSA* DUCH.) CV. WINTER DAWN

LOKESH KUMAR AND H.L. BAIRWA

Department of Horticulture, Maharana Pratap University of Agriculture and Technology, Rajasthan

ABSTRACT

The experiment was carried out on strawberry cv. Winter Dawn at Horticulture farm, RCA, MPUAT, during 2020-21 with the objective to response of Foliar Spray of Iron in Strawberry (*Fragaria* × *ananassa* Duch.) cv. Winter Dawn under Southern Rajasthan condition to get optimum plant growth with maximum fruits with the best quality an was carried out. Seven treatment combinations comprising iron, zinc and boron in different concentration were tried in Random Block Design (RBD) with three replications. The treatment was denoted as T₁ - RDF + Control (Water spray), T₂- RDF + FeSO₄ (0.2%), T₃ - RDF + FeSO₄ (0.4%), T₄ - RDF + Borax (0.1%) + ZnSO₄ (0.2%) + FeSO₄ (0.2%), T₅ - RDF + Borax (0.1%) + ZnSO₄ (0.4%) + FeSO₄ (0.4%), T₆ - RDF + Borax (0.2%) + ZnSO₄ (0.2%) + FeSO₄ (0.2%) and T₇ - RDF + Borax (0.2%) + ZnSO₄ (0.4%) + FeSO₄ (0.4%). The treatment was applied through foliar application at 30, 45 and 60 days after planting. The cultural operation follows uniform throughout the investigation. The results of the experiment indicated that majority of vegetative parameters like petiole length (8.50 cm), plant spread 27.87 cm (E-W)&23.87(N-S), number of leaves per plant (24.93) and runner production per plant (3.60), fruit yield parameters like days taken to first flower initiation (57.67), days taken to initiation to fruit set (60.73), days taken to first harvest, days taken to final harvest, number of picking, fruit length, length: diameter ratio (1.23), fresh weight of fruit (10.95g), number of fruit per plant (16.00) and quality parameter characters like TSS (11.90 °B), TSS: Acid ratio (13.79), juice per cent (63.95) and ascorbic acid (60.62 mg 100g⁻¹) were increased significantly while decrease in acidity (0.87 %) by T₇. i.e. RDF + Borax (0.2%) + ZnSO₄ (0.4%) + FeSO₄ (0.4%).

CHARACTERIZATION OF SEEDLING GENOTYPES OF WALNUT FOR BETTER HORTICULTURAL TRAITS IN SOLAN AND SIRMOUR DISTRICTS OF HIMACHAL PRADESH

PARAMJEET SAJWAN*, GIRISH SHARMA, DEEPIKA NEGI, HEERANDERA PRASAD AND KIRAN THAKUR

Dr. YSP UHF Nauli Solan Himachal Pradesh-173230.

ABSTRACT

The present investigation entitled “Characterization of seedling genotypes of walnut for better horticultural traits in Solan and Sirmour districts of Himachal Pradesh” was carried out at two districts Solan (S) and Sirmour (SS). 90 genotypes were characterized in three different girth classes (C-I, C-II and C-III). The results revealed that in C-I tree height was (5.10-11.12 m), trunk girth (0.95-1.48 m) and yield (15.50-45.60 kg/tree), whereas in C-II, tree height (9.75-13.73 m), trunk girth (1.52-2.49 m) and yield (20.00-47.52 kg/tree) and in C-III, tree height (10.40- 15.82 m), trunk girth (2.52-3.29 m) and yield (16.55-60.55 kg/tree). Nut weight parameter showed considerable variability, which extended from 7.50-15.86 g, maximum in C-II (Solan S-24) and minimum in SS-7(7.50 g). Nut thickness was highest in SS-23 (38.65 mm) and lowest in C-III, SS-26 (21.21 mm). Shell thickness ranged from 1.10-2.73 mm, lowest was in SS-8 (C-II) and highest in Solan S-11 (2.73 mm) in C-III. Kernel weight varied from 2.54-8.80 g, maximum was in genotype Solan S-45 (8.80 g) in C-III and minimum SS-9 (2.54 g) in C-I. Kernel thickness was highest in Solan S-35 (30.12 mm) in C-III and lowest in Solan S-22 (17.54 mm) in same girth class. Kernel percentage varied from to 21.83- 59.96 per cent, least was in SS-27 (21. 83 %) in C-III and highest in SS-20 (59.96 %) in C-I.

Keywords: Walnut Selection, Characterization, Genotypes

ROLE OF ROOTING MEDIA IN PRODUCTION OF QUALITY PLANTING STOCK

SACHIN VERMA

Department of Silviculture and Agroforestry, Dr. Yashwant Singh Parmar University of Horticulture and Forestry, Nauni, Solan -173230

ABSTRACT

According to global forest resource assessment there are 187million hectares plantation worldwide representing about 5 per cent of the global forest area. A part of plantation trees is also planted in semi natural forest in agroforestry ventures in public parks and in urban areas throughout the world and year after year. Planting trees can be an alternative or a supplement to the natural method of stand regeneration and a way of introducing or returning forests to areas where they are currently absent. These activities require a great number of planting stock. The majority of planting stock used in forestry comes from nurseries that specialize in its production. The special plantation drives and environmental clearance compulsion by greening activity also increase the demand of seedlings. The quality and quantity of benefits expected from trees outside forest. Mainly depend upon choice of species, seedling quality and their field management. Inadequate availability of quality planting material is one of the important determining factors in development of a sound horticulture and forestry industries. Rooting media being store house of water, air and mineral supply ensuring easy germination for rooting of plant cuttings. Therefore, rooting media can play an important role in production of quality planting stock.

Keywords: Germination, planting stock, regeneration, agroforestry, horticulture

PREPARATION AND CHARACTERIZATION OF MODIFIED REDMUD FOR ARSENIC REMEDIATION

SIYARAM MEENA*, KAPIL A. CHOBHE, K.M. MANJIAH, S.P. DATTA, CHINMAYEE BEHERA, RAVI SAINI

Division of Soil Science and Agricultural Chemistry, ICAR-Indian Agricultural Research Institute, New Delhi -110012, India

ABSTRACT

Excessive accumulation of Arsenic (As) in agricultural land is a rising cause of worry due to the negative impacts on soil ecosystems and the possible risk to the food chain. Excessive intake of As disrupts a variety of physiological and metabolic processes in humans, posing a risk. More than 150 million people throughout the world are at risk from arsenic pollution in their drinking water. As a result, treating As-contaminated soil and water may be the sole viable alternative for reducing the health risk. Researchers are focusing on removing arsenic using a range of approaches, including precipitation, flocculation, adsorption, ion exchange, membrane filtration, bioremediation, and sophisticated treatment methods like ozonation and electrochemical technologies. Adsorption has been one of the finest ways for removing arsenic from soil and water, because it has been shown to be exceedingly efficient, economical, versatile, and quick, with minimum sludge generation, recycling, and recycle potentials. Thus, in this study inorganic modification was performed on the raw redmud using CaCl_2 . The pH, cation exchange capacity (CEC), specific surface area (SSA), reactive functional groups, surface morphology, and size of unmodified and modified redmud samples were characterized. By Modifying the surface properties of naturally occurring redmud, we increased their adsorption efficacy in the remediation of environmental Arsenic contamination.

Keywords: Redmud, Arsenic, Adsorption, Contamination, Food Chain

STATUS OF SOIL ORGANIC CONTENT OF SOILS UNDER VEGETABLE CULTIVATION IN SUB-MONTANE AND SUBTROPICAL ZONE OF HIMACHAL PRADESH

SWAPANA SEPEHYA¹, DIXIT¹, ANIL KUMAR¹, RAKESH SHARMA¹ AND DEEPA SHARMA²

¹Department of Soil Science and Water Management, COHF (YSPUHF) Neri, Hamirpur, (H P) India

²Department of Vegetable Science, COHF (YSPUHF) Neri, Hamirpur, (H P) India

ABSTRACT

The investigation was undertaken to assess the effect of vegetable cultivation on the status of soil organic carbon content and to determine its correlation with other soil properties. For this, 45 soil sampling sites were selected randomly and 90 representative soil samples from cultivated and buffer conditions were collected. The results revealed that the organic carbon content of soil under cultivated conditions varied from 6.8 to 17.2 g kg⁻¹, while it ranged between 4.5 to 7.0 g kg⁻¹ under buffer conditions. Among various sites selected for the study under cultivated and buffer conditions, Bilkar Kahan village in Bihari block of Hamirpur district (17.2 and 7.0 g kg⁻¹) recorded the highest organic carbon content, whereas Bhalana village in Sujampur block of Hamirpur district recorded the lowest organic carbon content (6.8 and 4.5 g kg⁻¹). Among districts, Bilaspur district recorded the highest mean organic carbon content (12.0 g kg⁻¹), whereas lowest mean organic carbon content was observed in district Una (9.9 g kg⁻¹). The CV of 21.66 under cultivated conditions of vegetable production and 10.27 under buffer conditions indicates that it varied spatially. In general, comparatively higher organic carbon was observed under cultivated conditions over buffer conditions with overall mean values of 10.8 and 5.6 g kg⁻¹, respectively. Results further showed that the organic carbon content was found to have highly significant and positive correlation with microbial biomass carbon content (0.842**). It also showed significant and positive correlation with the maximum water holding capacity (0.420**), available nitrogen (0.579*), potassium (0.369*), sulphur (0.629**), exchangeable magnesium (0.417**) and DTPA-extractable iron (0.324*), copper (0.299*), zinc (0.322*) and manganese (0.547**), microbial biomass nitrogen (0.763**) and soil respiration (0.657**).

Keywords: Organic carbon, vegetable cultivation, correlation.

APPLICATION OF NANO-TECHNIQUES IN VEGETABLE CULTIVATION: POTENTIAL AND LIMITATIONS

ASHIMA CHAUDHARY AND HEERENDRA PRASAD

Department of Vegetable Science, Dr Yashwant Singh Parmar University of Horticulture and Forestry, Nauni, Solan (HP)

ABSTRACT

Nanotechnology is the art and science of manipulating and rearranging individual molecules at nanoscale to create useful materials, devices and systems. It is a promising field of interdisciplinary research. The potential uses and benefits of nanotechnology are enormous. Agriculture is the backbone of most developing countries, with more than 60% of the population reliant on it for their livelihood. As well as developing improved systems for monitoring environmental conditions and delivering nutrients or pesticides as appropriate, nanotechnology can improve our understanding of the biology of different crops and thus potentially enhance yields or nutritional values. Nanotechnology has promising applications in

all stages of production, processing, storing, packaging and transport of agricultural products and also in nanoparticle gene mediated DNA transfer. It can be used to deliver DNA into plant tissues for protection of host plants against insect pests. The reduced use of herbicides, pesticides and fertilizers with increased efficiency, controlled release and targeted delivery will lead to precision farming. Modern agriculture is need of hour because conventional agriculture will not be able to feed an ever-increasing population with changing climate, depleting resources and shrinking landscape. But at the same time application of nano-materials in agri-food sector has to be evaluated for public acceptance so it does not come across a scenario as faced by GMOs in past. Nanotechnology has great potential in agriculture as it can enhance the quality of life through its applications in fields like sustainable and quality agriculture and the improved and rich food for community.

Keywords: Nanotechnology, Herbicides, Pesticides.

HUNDRED YEARS OF GARLIC PRODUCTION OF INDIA

JAYESH GARG, HEERENDRA PRASAD AND SHIVANI SHARMA

Department of Vegetable Science, Dr Yashwant Singh Parmar University of Horticulture and Forestry, Nauni, Solan, Himachal Pradesh, India

ABSTRACT

Garlic (*Allium sativum* L.) is one of the most widely cultivated *Allium* species belonging to the family Alliaceae, with diploid chromosome number 16. The primary centre of origin of garlic is Central Asia whereas, the Mediterranean region is considered as its secondary centre of origin. Garlic is cultivated all over India mainly in Gujarat, Odisha, Madhya Pradesh, Rajasthan, Uttar Pradesh and Maharashtra. It has been grown for culinary, medicinal, and religious purposes for several millennia. Garlic has several medicinal properties and its reputation as a medicine has increased to such an extent that garlic oil capsules are now marketed through pharmacies and health food stores. It is consumed both fresh as well as in dried forms as an important ingredient for flavoring various vegetarian and non-vegetarian dishes. It is also important foreign exchange earner for India. India has become one of the biggest exporters of garlic worldwide. Healthy and big size cloves are used for planting as they result in good yields. Garlic is a heavy feeder of nutrients. Reasons for low yield of garlic are mainly depletion of macro and micronutrients from the soil, use of low yielding varieties with low or no inputs and poor management practices. Nowadays the concept of nanotechnology is emerging as it can not only reduce uncertainty but also coordinate the management strategies of agricultural production as an alternative to conventional technologies. Apart from the conventional agro techniques, the modern approach of garlic cultivation includes the use of precision farming techniques, which includes plastic culture, micro-irrigations, nanofertilizers, farm mechanization and remote sensing. Proper post-harvest management of garlic will open new opportunities for the growers to cultivate it on the large scale.

Keywords: Farming, Garlic, Ingredient, Management, Opportunities

BIOTECHNOLOGICAL INTERVENTIONS IN WOOD INDUSTRIES

RAVEENA THAKUR*, BHUPENDER DUTT, RAJNEESH KUMAR AND ROHIT SHARMA

Department of Forest Products, Dr. Yashwant Singh Parmar University of Horticulture and Forestry, Nauni-Solan (HP) -173230

ABSTRACT

Wood is a natural, biodegradable and renewable raw material, mainly used in construction, furniture and fuel production. Besides solid wood, wood-based products such as paper products (various types of paper, cardboard) and board materials (particle & fibre boards) are of great industrial importance. Wood based industries are emerging tremendously to meet the demand of continuously increasing population. However, most of the industrial processes adversely affect the environment, due to direct release of harmful chemicals and wastewater. To cope up with this, biotechnological interventions play an important role. Biotechnology is defined as the technical use of living organisms or parts thereof, in making new products or processes. Industrial application of biotechnology is mainly based on fungal cultures and fungal isolated enzymes. Biotechnological methods in the pulp and paper industry include bio-pulping, enzymatic bleaching, pitch control and purification of wastewater. Biotechnological approaches in the area of wood industries aim at enhancing the treatability of wood with enzymes extracted from different microbes, mostly fungi and replacing chemicals used for different processes with biological control agents. For instance, the substitution of conventional chemical glues in the manufacturing of board materials and pitch control is achieved through the application of isolated fungal enzymes. Moreover, biotechnology plays an important role in saving energy and reduction of environmental hazards. Besides the advantages, biotechnological applications in wood industries faces many challenges like complexity, unreliability, high cost of enzymes and inadequate knowledge of the methods, whereas; major problem lies in their commercialisation. Nevertheless, many applications are still not developed at the industrial level, but the use of biotechnology has great potential in wood industry, and need more research.

Keywords: Bio-pulping, Biotechnology, Enzymes, Fungal cultures

EFFECT OF TRAINING SYSTEMS AND SPACING LEVELS ON VEGETATIVE AND QUALITATIVE CHARACTERS OF TOMATO (*Solanum lycopersicum* L.) UNDER CONTROLLED CONDITIONS

RUKSANA*, AMIT SAURABH AND VEDIKA SHARMA

Department of Horticulture, Dr. Khem Singh Gill Akal College of Agriculture, Baru Sahib, Sirmour, Himachal Pradesh, India

ABSTRACT

The present study entitled the effect of different training systems and spacing levels on growth, yield and quality of tomato (*Solanum lycopersicum* L.) under protected conditions was conducted in the year 2021 at Experimental Farm Chhapang of Dr. Khem Singh Gill Akal College of Agriculture, Eternal University, Baru Sahib. The experiment was laid out in Randomized Block Design with three replications and nine treatment combinations. There were three different training systems and three spacing levels. Results revealed that single stem training system recorded maximum value for different vegetative characters like plant height, plant spread, leaf area, number of leaflets per leaf and internode distance) and qualitative characters lycopene, pericarp thickness and TSS. Closer spacing recorded best results for

vegetative characters viz. Days to first flowering, Plant height, Internode distance and Days to first harvest. While wider Spacing recorded best results for vegetative characters like Plant spread, leaf area, number of leaflets per leaf and qualitative characters like lycopene, pericarp thickness and TSS. Treatment combination four stem training system with closer spacing recorded minimum value for vegetative characters like Days to first flowering and Days to first harvest and Qualitative character like Ascorbic Acid. Single stem and closer stem recorded maximum value for Plant height and Internode distance. Single stem and wider spacing recorded best results for vegetative character like plant spread, leaf area and number of leaflets per leaf and Qualitative character like Lycopene. Four stem training system with wider spacing recorded the maximum value best results for qualitative characters like TSS and pericarp thickness.

Keywords: Spacing, Tomato, Training, Vegetative, Qualitative

APPLICATION OF ARTIFICIAL INTELLIGENCE IN INSECT PEST MANAGEMENT

SAKSHI SHARMA* AND SAPNA KATNA

**Department of Entomology, Dr. YS Parmar University of Horticulture and Forestry
Nauni, Solan (H.P)**

ABSTRACT

World is facing an emerging challenge of food security. The global population is expected to reach more than nine billion by 2050. To avoid food security crisis, a 70% growth in agricultural production is required which can be achieved by intensification of current production, as availability of arable land is limited. One of the main constraints with intensification of current production has been the insect pest infestation that results in losses to the tune of US\$70 billion annually around the globe. Consequently, agriculture needs help to eliminate this problem and requires new solutions for all aspects of agricultural production including insect pest infestation. Nowadays, the most popular and sustainable approach to controlling pests is Integrated Pest Management (IPM) which requires intensive field observation, trained staff, and data mining. In this context, it has emerged that the use of artificial intelligence (AI) algorithms is a necessity for controlling, tracking, and using these agricultural inputs at the optimal times). AI has applicability in providing solutions to problems that cannot be solved by human or traditional computing structures. It uses techniques like case based reasoning, rule-based reasoning, artificial neural networks, fuzzy logic systems and machine learning in the field of pest management, which are then constituted as Expert Systems and Decision Support Systems that emulates and helps the users to reach the most appropriate decisions. In turn, all these techniques and interfaces translates into the agricultural field by the introduction of smart machines, devices and farming systems like robotics, computer vision and precision farming that can aid agriculturists in managing pests efficiently.

Keywords: Algorithms, integrated, fuzzy, pests

OFF-SEASON VEGETABLE PRODUCTION: IMPACT ON DIVERSIFICATION AND FARM INCOME

SHIVANI SHARMA* JAYESH GARG AND HEERENDRA PRASAD

Department of Vegetable Science, Dr Yashwant Singh Parmar University of Horticulture and Forestry, Nauni, Solan (HP)

ABSTRACT

India is the second largest producer of vegetable crops in the world. Vegetable crops provide food and nutritional security to millions of people and the cultivation is a profitable venture that assured better returns to the farmers in terms of higher yield, better quality produce, more labour engagement and higher economic return. Off-season cultivation of different high value and more demanding crops under protected cultivation in greenhouses, polyhouse, shade net, poly tunnels etc. is a highly remunerative venture. In Himachal Pradesh, agriculture is a very crucial part of the state's economy as it is the main occupation of people. High-value crops like vegetables can potentially increase farmer's income as demand for high-value food products is increasing more quickly than that of the cereal crops. The crop diversification towards selective high value crops including fruits and vegetables, compatible with the comparative advantage of the region, is recommended as an effective strategy in raising incomes, generating employment opportunities and alleviating poverty among small and marginal households. The development of low cost naturally ventilated bamboo based small greenhouses technology provides an excellent opportunity in hills agriculture by virtue of maintaining congenial environmental conditions to produce high quality vegetables and assured regular supply during off season. Its large-scale adoption could lead to enough production for both domestic as well as export market. Thus, off-season production of vegetable crops ensures the round the year production of vegetable crops and maintains the demand and supply of vegetables in the market and ensures high profitability to the growers.

Keywords: Off-season, vegetables, greenhouses, high-value crops, diversification

THE DEVELOPMENT OF AGRICULTURAL VALUE THROUGH EFFECTIVE SUPPLY CHAIN MANAGEMENT

SHIVANI SINGH* AND KRISHAN KUMAR RAINA

Department of Business Management, Dr Yashwant Singh Parmar University of Horticulture and Forestry, Nauni, Himachal Pradesh, India

ABSTRACT

It is observed that the post-harvest losses have impacted both micro and macro levels of economy. The agricultural marketing sector is characterized by fragmented supply chain huge post-harvest losses, multiple intermediaries, higher transaction cost, lack of consciousness and several other socio-economic factors are some of the main problems being faced by Indian Agriculture. However, in India food supply chain is highly fragmented. The numbers of intermediaries are important as they do act as a substitute for infrastructure where none exists. But from last few years, these intermediaries have grown most of which add insignificant value to the produce but jointly add some to the final cost. Supply chain is a composed and coordinated process of producing value for the end user or to the ultimate consumer. The real measure of supply chain is how well the activities under the process coordinate the across the supply chain to create its value to the consumer, while gaining from every link in the supply chain. Using supply chain integration as an organizational core tactical tool it will help to boost agri-business performances to remain and sustain competitive edge over rivals. Therefore, the

managers of agri-business, policymakers, governmental and other interested bodies are encouraged to broaden the scope of advocacy in efficient supply chain integration culture to ensure effectiveness and speedy accomplishment of organizational objectives. In the 21st century, a sustainable agricultural supply chain is not solely about practicing farm cultivation, rather it includes warehousing, transportation, manufacturing and distribution and considering what is best for survival of the company and also what is best for environment and for biodiversity.

Keywords- socio-economic, post-harvest losses, consumer, performances

VEGETABLE DIVERSIFICATION: A BOON FOR INCREASING FARMERS INCOME IN HILLS

SHRADDHA* AND BHARDWAJ RK

Department of Vegetable Science, Dr. YS Parmar University of Horticulture and Forestry Nauni, Solan (H.P)

ABSTRACT

The agriculture in hilly areas is not solely an occupation but a way of life and has become an essential part of the economic and cultural set up. The productivity of hills is stagnant as there is cereal-based agriculture. Mono-cropping is exposed to high risks in the event of vagaries of climatic events that could critically impact agricultural production, such as emergence of pests and the sudden onset of frost or drought. Therefore, crop diversification using selective highvalue cash crops including fruits and vegetables, compatible with the comparative advantage of the region, is suggested as a viable solution to stabilize and raise farm incomes. Hilly areas have a potential of off-season production of vegetables. Vegetables, the main source of vitamins and minerals, are very utilitarian in the rotational system of farming for maintenance of soil fertility and also providing better crop intensification as well as diversification. From the point of view of profitability, vegetables like potato, tomato, cauliflower, peas have proved themselves in obtaining higher return in comparison to other crops and also having higher Benefit-Cost ratio (B:C ratio). Demand of exotic vegetables like lettuce, asparagus, celery, swiss chard, parsley, brussels's sprouts, broccoli and red cabbage, etc. among the mid and high-income population of Delhi is also very high. Thus, these vegetables are affordable to five-star hotels and large restaurants. For this reason, hill vegetables are fetching higher prices and sold at a premium. These do not face any competition from identical producer of the Plains; thus producers have an absolute advantage in vegetable production as compared to other crops. Presently, the supply of these vegetables is very limited. Hence, demand for these vegetables would increase in near future. To achieve the desired results area under vegetable cultivation should be increased in hills, area under exotic vegetables must be increased immediately to bridge the gap between demand and supply.

Keywords: Diversification, Vegetables, Off-season, High income

BIOFORTIFICATION OF VEGETABLES FOR NUTRITIONAL SECURITY

SPARSH MADAIK, JAYESH GARG AND HEERENDRA PRASAD

Dr Yashwant Singh Parmar University of Horticulture and Forestry, Nauni, Solan (HP)

ABSTRACT

The world population is anticipated to rise to 9.8 billion by 2050. The agricultural production and supply chain are the most vulnerable to current global crises like climate change and the COVID-19 pandemic. The pandemic threatens global human life and health, which will be further worsened by intensifying hunger and malnutrition from disrupting the food supply chain mainly in developing countries and it is escalating the challenges for global food security. Despite consuming a carbohydrate-rich diet, the problem of hidden hunger persists, as we are unable to fulfil micronutrient requirements. Most of the disorders caused due to micronutrient deficiency can be reversed with the proper diet, while some cause lifelong impairments such as iodine deficiency in early pregnancy, which causes intellectual incapacity in children. Considering the severity of its consequences eradicating malnutrition is the only sustainable solution to achieving a healthy world. Biofortification is the process of enriching the nutritional status of staple food crops by mounting the nutrient content or bioavailability either through agronomic methods, conventional breeding, or biotechnological tools. This is an elite technique to overcome hidden hunger by the addition of desired minerals to improve the quality of crops. Nutritional targets for biofortification includes elevated mineral content, improved vitamin content, increased essential amino acid levels, better fatty acid compositions and heightened antioxidant level in crops. Biofortified crops provide a low-cost way of reaching people having poor access to formal and health-care systems. Some workers summarised that the biofortified staple food might be unable to furnish as high level of minerals and vitamins per day as the supplemental or industrially fortified food products, but assist in enhancing the daily adequacy of micronutrients intake among the individuals throughout their life cycles.

Keywords: Biofortification, Nutritional Security

ESTIMATION OF SOIL ORGANIC CARBON ALONG AN ALTITUDINAL GRADIENT OF *PINUS ROXBURGHII* FORESTS IN THE GARHWAL HIMALAYA, INDIA

*¹AMIT KUMAR, ²MUNESH KUMAR, ³TARUN KUMAR THAKUR

¹School of Hydrology and Water Resources, Nanjing University of Information Science and Technology, Nanjing, 210098, PR China

²Department of Forestry and Natural Resources, HNB Garhwal University, Srinagar Garhwal, 249161, India

³Department of Environmental Science, Indira Gandhi National Tribal University, Amarkantak, 484887, India

ABSTRACT

In the Indian Himalayas, *Pinus roxburghii* forests are the dominant species and act as a huge carbon sink. However, carbon sink measuring in forest soil is tedious and time-intensive, thus in this study, remote sensing and geographical information system (RS-GIS) approaches are being applied to estimate the soil organic carbon (SOC) in the Garhwal Himalaya, Uttarakhand. In this study, SOC stock of *Pinus roxburghii* along an altitudinal gradient (<1000, 1001–1400, 1401–1800, and >1801 meters above mean sea level) has been estimated at three soil depths (0–30, 30–60, and 60–100 cm). To understand the vegetation information, a normalized difference vegetation index (NDVI) was applied. Result reveals that SOC (0 to 100cm) was

increased with an increase in altitude range. Further results showed that NDVI was a good predictor for SOC estimation in the forest region. The model predicted SOC stock between 57 to 152 Mg ha⁻¹ with a mean of 93 Mg ha⁻¹, which was close to the estimated SOC from field-based inventory. Therefore, RS could be strongly used for SOC mapping in the Himalayas Forest through NDVI which will further help the policymakers in carbon reduction conservation and forest management.

Keywords: climate change, forest, soil organic carbon, NDVI, carbon dynamics

STANDARDIZATION OF BUDDING TECHNIQUES FOR PROPAGATION OF SWEET CHERRY (*PRUNUS AVIUM* L.).

POOJA AND HEERENDRA PRASAD

**Department of Fruit Science, Dr YS Parmar University of Horticulture and Forestry
Nauni, Solan (HP) 173 230**

ABSTRACT

Sweet cherry (*Prunus avium* L.) is a major temperate fruit crop world-wide. Due to better yield, cherry is favoured in temperate locations. In recent years, grafting and budding have given encouraging results in propagating temperate fruits and are gaining commercial popularity. Budding is easier and quicker than grafting, because stock plants yield more buds than grafts, lowering the number of stock plants needed to raise the same number of young trees. The experiment was laid out in Split Plot Design which consisted of three types of budding (chip, shield and annular) as main plot treatments, and sub plot treatments included five different dates (May 15, May 30, June 29, August 28, and September 12) which were replicated four times. The results revealed that among the three methods of budding, chip budding recorded maximum bud-take success (52.21 %), linear growth of scion (67.97 cm) and percentage of saleable plants (59.80 %). Out of various dates of budding, plants budded on 12th September recorded maximum values for proportion of saleable plants (72.92 %). However, appreciable success was recorded in parameters *viz.* per cent sprouting (83.00 %), bud-take success (68.99 %), linear growth of plant (66.18 cm) during 15th may and 30th May. Considering the successful budding and percentage of commercial grade plants, chip budding between May 15th and May 30th can be recommended for cherry propagation.

Keywords: Budding, grafting, bud-take success

IMPACT OF AGRONOMICAL APPROACHES ON GROWTH, YIELD, AND ECONOMICS OF BELL PEPPER (*Capsicum annuum* L.) var. SOLAN BHARPUR UNDER MID-HILLS OF HIMACHAL PRADESH

PRIYANKA BIJALWAN^{*1}, SHILPA², YR SHUKLA³ AND MANISH CHAUHAN³

¹Himgiri Zee University, Sherpur, Dehradun, Uttarakhand (248197) India

²Department of Vegetable Science, CSK Himachal Pradesh Agriculture University Palampur, Himachal Pradesh (176062) India

³Department of Vegetable Science, Dr YS Parmar University of Horticulture and Forestry, Nauni, Solan (HP) (173230) India

ABSTRACT

Capsicum annuum L., popularly known as bell pepper, sweet pepper, and ShimlaMirch, is a vegetable crop in the Solanaceae family. Because of its various nutritional benefits, capsicum is ranked one of the healthiest vegetables; therefore, the desire for this is expanding every day. Through its importance and market requirement in consideration, a study was conducted to assess the impact of planting methods, mulches, and NAA treatment on bell pepper growth, yield, and economics. The study was performed at Experimental Farm of the Department of Vegetable Science, Dr. Y S Parmar University of Horticulture and Forestry, Nauni, Solan (HP) during *Kharif* seasons years 2017-18 and 2018-19 (two years). The experiment was laid out in a randomized block design with three replications comprising twelve treatments. The study revealed that T₃ yielded maximum (384.69 q/ha) as well as recorded maximum values of gross return (Rs. 577,035.00/-), net return Rs. 3,52,416.93/- and comparatively less B:C ratio (1:57). Meanwhile, T₁ recorded 77.80% control in weed population and have maximum (64.12%) efficiency to control emerging weeds as compared to T₁₂.

Keywords: *Capsicum annuum* L., planting methods, mulching, yield, economics.

GROWTH, YIELD AND NITROGEN USE EFFICIENCY OF DIFFERENT RICE GENOTYPES UNDER VARIABLE NITROGEN RATES

RAVI SAINI^{1*}, K.M. MANJAIHAH², KAPIL A. CHOBHE³, SIYARAM MEENA¹

¹Division of Soil Science and Agricultural Chemistry, ICAR-IARI, New Delhi

²ICAR-IARI, New Delhi

³Division of Soil Science and Agricultural Chemistry, ICAR-Indian Agricultural Research Institute (IARI), New Delhi -110012, India

ABSTRACT

Rice is the second most widely consumed cereal in the world after wheat, thereby, occupying a pivotal role in the food and livelihood security of families. Fertilizer nitrogen (N) use efficiency (NUE) of lowland rice, generally ranging from 20% to 40% is mainly due to the losses of N occurring from paddy field. The study of different rice genotypes with respect to nitrogen use efficiency and understanding the plant traits that are associated with high grain yield and high NUE is very important to identify N-efficient genotypes. In present study, we studied five rice genotypes (Swarna, Pusa-44, PB-1, MTU 1010 and Nagina-22) for their response to variable N rates. To accomplish the above objective, a pot culture study was conducted in green house at Division of Soil Science and Agricultural Chemistry, ICAR-IARI, New Delhi. Grain yield and NUE were significantly differed among the five rice genotypes at N application rate of 120 kg ha⁻¹. Among varieties highest biomass was recorded in PB-1 which did not vary significantly with Swarna, whereas the highest grain yield was obtained in Swarna. The grain yield obtained in Pusa-44 and PB-1 were statistically at par with each other. The

lowest grain yield was obtained in Nagina-22 variety. Highest N uptake was recorded in Swarna followed by pusa-44 and PB-1 and lowest was recorded in Nagina-22 which least N responsive among the selected genotypes. Although Nagina-22 variety recorded the highest chlorophyll content but N uptake was lowest as compared to rest of genotypes because of least responsiveness of the Nagina-22 genotype. Among genotypes, the best variety in terms of N use efficiency was Swarna whereas; Nagina-22 was least N responsive variety irrespective of fertilizer dosages.

Keywords: *Nitrogen, Genotypes, Efficiency, Response, Traits*

NORTH-WESTERN HIMALAYAS AS A REPOSITORY FOR INDUSTRIALLY IMPORTANT MEDICINAL HERBS, AND COMPREHENSIVE INSIGHT OF MEDICINAL PLANT BIOTECHNOLOGY VIS-A-VIS TO THEIR CONSERVATION AND BIOACTIVE COMPOUNDS HARNESSING

KAMAL THAKUR*, CHANCHAL KUMARI, ANAMIKA THAKUR, VINAY KUMAR, RAJNISH SHARMA, PARUL SHARMA

Department of Biotechnology, Dr. Y.S. Parmar University of Horticulture and Forestry, Nauni, Solan 173230 (HP) India

ABSTRACT

The Himalayas are considered to be a treasure trove of natural flora owing to their unprecedented biodiversity and unique geo-climatic conditions. Progressively, plants develop the ability to synthesise a myriad of important secondary metabolites (organic molecules with incredible chemical diversity) that have an impact on variety of biological functions across all form of life. Some of the significant plants in the North-Western Himalayas include *Saussurea costus*, *Trillium govanianum*, *Paris polyphylla*, *Dactylorhiza hatagirea*, *Angelica glauca*, *Aconitum heterophyllum*, *Fritillaria roylei*, *Picrorhiza kurroa*, and *Swertia chirayita* etc. These plants each have their own valuable parts (roots, bulbs, leaves, rhizomes, etc.) and tailored variety of SMs (secondary metabolites) that have been recognised as vital sources of aromatic flavours, pharmaceuticals, pesticides, food additives, pigments, and biofuel. But owing to the increase in demand, their natural habitat has been affected by climatic conditions, anthropogenic activities, ruthless collection, illegal and unorganised trade, and turning of most of these rare and endemic herbs into critically endangered species. It is therefore urgently necessary to find alternative sustainable techniques and policies to use these natural resources with simultaneous conservation. Moreover, in the last several decades, different biotechnological aspects have been exploited in some of these medicinal herbs as new and viable complementary options for plant conservation employing plant tissue culture, cryopreservation (short and long term), synthetic seed production, secondary metabolite production (using chemical and biological elicitors), genetic transformation, and molecular markers. So far, promising modern omics platforms (genome, transcriptome, proteome, and metabolome) have enabled us to gain a comprehensive understanding of candidate genes, enzymes, and regulatory sequences involved in the biosynthetic pathways of various plant-derived proteins and drugs with medical significance. On the other hand, modern biotechnological genome editing tools like CRISPR/cas9, Zinc finger nuclease, and TALENs (tail activators like effector nucleases) are needed to explore to produce designer medicinal plants with advanced traits, facilitating the production of pharmaceuticals and nutraceuticals. It is envisaged that information and databases retrieved from the medicinal plant biotechnological studies would be helpful in in-depth study and bioactive compounds production in medicinal plants.

Keywords: Biotechnology, Himalayas, Medicinal Plants, TALENS

PRODUCTIVITY POTENTIAL OF DIFFERENT MEDICINAL PLANTS UNDER PEACH BASED HORTI-MEDICINAL SYSTEM OF AGROFORESTRY

VIPIN KUMAR

Department of Forest Products, Dr Yashwant Singh Parmar University of Horticulture & Forestry (Nauni) Solan (HP) -173 230 India

ABSTRACT

The present investigations entitled ‘Productivity potential of different medicinal plants under peach based Horti-Medicinal System of agroforestry’ was carried out in the field of peach Department of Fruit Science and Medicinal and Aromatic Plants farm of Department of Forest Products, Dr YSP UHF Nauni, Solan. (HP) during 2016 to 2018. The experiment comprised of 9 treatments in *Lepidium sativum*, *Linum usitatissimum*, *Ocimum sanctum* and *Andrographis paniculata* with peach and without peach viz. T₁ (Peach + medicinal plant + FYM 2t/ha), T₂ (Peach + medicinal plant + FYM 4t/ha), T₃ (Peach + medicinal plant + Vermicompost 2t/ha), T₄ (Peach + medicinal plant + Vermicompost 4t/ha), T₅ (Peach + medicinal plant + Jeevamarutha 500 l/ha), T₆ (Peach + medicinal plant + RDF NPK kg/ha), T₇ (Peach + medicinal plant), T₈ (medicinal plant + RDF NPK kg/ha) and T₉ (Control). The maximum growth and yield of medicinal plants (*Lepidium sativum*, *Linum usitatissimum*, *Ocimum sanctum* and *Andrographis paniculata*) was found in T₆ (Peach + medicinal plant + RDF). In *L. sativum*, *L. usitatissimum* maximum estimated seed yield (9.93 q/ha and 7.90 q/ha, 10.16 q/ha and 8.03 q/ha) was recorded in T₆ during 2016-17 and 2017-18 in Rabi season respectively, where as in Kharif season maximum herb yield of *O. sanctum* and *A. paniculata* (16.27 q/ha and 17.13 q/ha and 5.05 q/ha and 5.54 q/ha) was recorded in T₆ during 2016-17 and 2017-18. In Kharif season maximum yield was found in second year as compared to first year. Economic analysis of *L. sativum*, *L. usitatissimum*, *O. sanctum* and *Andrographis paniculata* recorded that maximum gross return (Rs. 129090, Rs 101600, Rs 226350 and Rs 107400), maximum net return (Rs. 152166 and Rs 127556, Rs 125026 and Rs 98185.85, Rs 244357 and Rs 245237, Rs 133644.3 and Rs 137204.30) and B:C ratio (2.46 and 2.12, 2.08 and 1.62, 3.68 and 3.58, 2.33 and 2.35) were recorded in T₆ during 2016-17 and 2017-18. Use of recommended dose of fertilizers increased the availability of nutrients to the plant. Based on the findings of present studies it can be concluded that *Lepidium sativum*, *Linum usitatissimum*, *Ocimum sanctum* and *Andrographis paniculata* can be successfully grown under peach-based agroforestry system.

Keywords: *Lepidium sativum*, *Linum usitatissimum*, *Ocimum sanctum* and *Andrographis paniculata*

VALUE CHAIN MANAGEMENT OF FRUITS, VEGETABLES AND MINOR FOREST PRODUCE IN MANDI AND KULLU DISTRICTS OF HIMACHAL PRADESH

AMAN SHARMA AND KRISHAN KUMAR RAINA

Department of Business Management, Dr Y S Parmar University of Horticulture and Forestry, Nauni, Solan (HP) 173 230

ABSTRACT

The present study entitled “Value Chain Management Fruits, Vegetables and Minor Forest Produce in Mandi and Kullu Districts of Himachal Pradesh” was conducted in Mandi and Kullu districts of Himachal Pradesh. A sample of 375 farmers was drawn by using simple random technique. Five marketing channels were prevalent in the study area for marketing of

vegetables, fruit and forest produce viz., Channel-I (Producer → Consumer), Channel-II (Producer → Wholesaler → Retailer → Consumer), Channel-III (Producer → Pre-Harvest contractor → Wholesaler → Retailer → Consumer), Channel-IV (Producer → Forwarding Agent → Wholesaler → Retailer → Consumer) and Channel-IV (Producer → Retailer → Consumer). The most favored channel adopted by vegetable growers in the study area was Channel-II & III as the highest proportion of total marketed produce moved through these channels. While major problems faced by forest produce collectors were forest fire and climate variations.

Keywords: Value chain; Management; Fruits; Vegetables; Minor Forest Produce; Channel

EVALUATION OF BOTANICALS IN MINIMIZING SEED- BORNE FUNGI OF WHEAT IN IN-VITRO STUDY

NEHA PATHAK*, UMA SHARMA AND RUCHI AGRAWAL

Department of Botany, Sanskriti University, Mathura, India

Many important diseases of cereals can be seed-borne. Seed health testing for the presence of both type of seed-borne pathogens is an important step in the management of plant diseases. Early and accurate diagnoses and pathogen surveillance will provide time for the development and the application of disease management strategies. Among the different disease-causing agents, fungi are major agents responsible for seed deterioration. Hence the present investigations were carried out to study the mycoflora associated with wheat seeds, deteriorations caused by these pathogens and to find out an effective control by integrated methods.

The detection of seed-borne fungi of wheat were done by using the blotter, agar plate and deep-freezing methods as recommended by ISTA. Of the three samples of wheat seeds collected from different places of Aligarh, a total number 15 species belonging to nine genera of fungi were isolated and identified on the bases of their mycelium growth and fruiting bodies *Alternaria alternata*, *Aspergillus niger*, *A. flavus*, *Rhizopus* spp., and *Mucor* spp were quite common in both external and internal seed mycoflora with high frequency value and relative abundance. Aqueous extract of leaves of *Euphorbia hirta*, *Lantana camara*, *Azadiracta indica*, *Calotropis procera*, *Eucalyptus globulus* were used against the fungal mycoflora. The samples were treated with fungicides and botanical to control the seed-borne pathogens. The factorial experiment was conducted in randomize complete block design with five replications. The results were recorded as regards to the highest seed germination (86.3%) reflected the lowest percentage of pathogen (5.0%) in the treated seeds with natural products.

Furthermore, the use of fungicides has resulted in the buildup of toxic chemicals potentially hazardous to man and environment and also in the buildup of resistance by pathogens. Therefore, the development of bio pesticides like plant extracts has been focused as a viable pest control strategy in recent years. Natural products produced by plants is definitely a new source of potential pesticides as different botanicals in the present studies gave encouraging results.

Keywords: Wheat. Seed-borne fungi, Botanicals, Bio-pesticides, Chemicals

ANTIMICROBIAL PROPERTIES OF LEAVES & STEM EXTRACTS OF *Ocimum sanctum* (Lamiaceae) Against Some Pathogenic Bacteria

UMA SHARMA, RAJENDRA SHARMA, SEEMA BHADAURIA AND NEHA PATHAK

Department of Botany, RBS College, Agra

ABSTRACT

The ethanol and aqueous extracts of leaves & stem of *Ocimum sanctum* were subjected to see their effect against two species of pathogenic microorganisms: *Citrobacter freundii* and *Micrococcus luteus*. The antibacterial activity was analyzed using disc diffusion method at different inhibitory concentration. The results revealed that ethanol was the best extractive solvent for antibacterial properties of leaf and stem extracts. The maximum activity was recorded against *Citrobacter freundii* at 12.5mg/ml concentration with 20.00 mm zone of inhibition. The results also indicated that leaf extract of all the tested plants inhibit the growth of both bacterial strains significantly as compared to stem extract. The obtained results provide a support for the use of these plants in traditional medicine and suggest their further advance investigation.

Keywords: Antimicrobial properties, aqueous extract, Ethanolic extract, disc diffusion, *Ocimum sanctum*, traditional medicine.

IN VITRO MUTAGENESIS FOR SALINITY TOLERANCE IN BANANA (*Musa paradisiaca* L.) cv. GRAND NAINE

RAJNI RAJAN^{1,2*} AND M. FEZA AHMAD¹

Lovely Professional University, Phagwara, Punjab, India

Bihar Agricultural University, Sabour, Bihar, India

ABSTRACT

The present investigation entitled “*In vitro* mutagenesis in banana (*Musa paradisiaca* L.) cv. Grand Naine for its improvement against salinity” was carried out in the Division of Horticulture (Fruits and Fruit Technology), BAU, Sabour during 2017-20 with the aim to develop salinity tolerant mutant in banana cv. Grand Naine. The irradiation experiment was carried out in 5 × 5 factorial complete randomized design consisting days of subculture (DAS) (4 DAS, 7 DAS, 10 DAS, 13 DAS and 16 DAS) and irradiation doses (0 Gy, 10 Gy, 20 Gy, 30 Gy and 40 Gy) as well as chemical mutagen doses (Control @ 0 mM, EMS @ 3 mM, EMS @ 5mM, DES @ 3 mM, DES @ 3 mM, NaN₃ @ 1mM, NaN₃ @ 2 mM) respectively. As many as seven markers for identification of salinity have been used where Ma2/3 showed no amplification whereas Ma1/3 and STMS 1fp/1rp showed amplification at 160 bp and 250 bp were selected for salinity tolerance in banana. 10 Gy when exposed over 13 DAS distinguished positive for markers related to salinity while 20, 30 and 40 Gy were found positive at 4 DAS and 7 DAS. EMS @ 3 mM, EMS @ 5 mM and DES @ 5 mM at the 4, 7 and 10 DAS was found positive for salinity markers. Out of 1100 putative mutant lines generated, 134 lines were confirmed through molecular markers, when screened under *in vitro* salinity experiment. 12 mutant lines were further used for *in vivo* salinity experiments. Under *in vivo* condition, lines treated with lower doses of gamma irradiation 10 Gy and 20 Gy and EMS were most effective to improve plant tolerance to salinity.

Keywords: mutation, banana, irradiation, salinity, tolerance

PHYSICO-CHEMICAL ANALYSIS OF DRINKING WATER, WATER SEWAGE AND SOIL OF GLASS INDUSTRIAL AREA OF FIROZABAD DISTRICT IN UTTAR PRADESH, INDIA

RAJAN KUMAR VERMA¹, MANISH KUMAR² AND AKHILESH KUMAR³

Deptt. of Chemistry, Narain College, Shikohabad Firozabad ,U.P. India ¹,

Deptt. of Zoology, Narain College, Shikohabad, Firozabad ,U.P. India²

Deptt. of Physics, Narain College, Shikohabad,Firozabad ,U.P. India³

ABSTRACT

Ground water is one of the most useful water sources. Contamination of such water source is a big problem creating health hazards. The glass and dying units at small scale levels in the glass city of Uttar Pradesh are ever increasing. The industrial waste from different industries plays a vital role in toxicating the ground water quality. In the present study, we have collected groundwater samples, water sewage and soil from different places of Firozabad district (U.P.) India. These samples have been analysed on the basis of various qualitative parameters. Estimation of physicochemical parameters like (temperature, pH, TDS, electrical conductivity, alkalinity, acidity, total hardness, BOD, COD, Na⁺, K⁺, Cl⁻, F⁻, nitrate, phosphate, sulphate) was carried out. This study was aimed to assess the suitability of the ground water, water sewage for the domestic and agricultural purposes and also analyse the quality of soil for removing the heavy metals like zinc, cadmium and mercury by using biological parameters and biological species. The main aim of the present study to reduce the pollution load and improve the water and soil quality in the selected area.

Keyword: Physicochemical parameter, water quality parameter, BOD, COD, Heavy metal

EFFECT OF ZINC MANAGEMENT PRACTICES ON GROWTH, YIELD AND ECONOMICS IN TRANSPLANTED RICE (*oryza sativa* L.) UNDER PARTIALLY RECLAIMED SALT-AFFECTED SOIL

DINESH KUMAR¹, PRASHANT SINGH² AND ARVIND¹

¹Department of Soil Science & Agril. Chemistry, Narain College Shikohabad, Firozabad, (U. P.) – 283135

²Department of Agronomy, NDU&T, Kumarganj, Ayodhya, (U.P.) - 224229

ABSTRACT

Field experiment for growth, yield and economics of transplanted rice variety Arize-6444, was conducted on student's instructional farm, Narendra Deva university of Agriculture & Technology Narendra Nagar Faizabad in during *Kharif* season of 2013. The treatment were included differences of zinc viz. T₁: control, T₂:soil application of 50kg ZnSO₄ ha⁻¹, T₃:soil application of ZnO equivalent to 50kg ZnSO₄ ha⁻¹, T₄: seedling dip in 10kg ZnSO₄ slurry ha⁻¹, T₅ : seedling dip in ZnO slurry equivalent to 10kg ZnSO₄, T₆ : foliar application twice with 0.2% ZnSO₄, T₇ : foliar application twice with ZnO equivalent to 0.2% ZnSO₄, T₈ : foliar application twice with Zn-EDTA equivalent to 0.2% ZnSO₄. The treatments were replicated thrice in Randomized Block Design. The experimental soil was silty loam in texture having pH 8.1, OC% 0.34, available N:170, P₂O₅: 16 and K₂O: 230 kg ha⁻¹. The crop was transplanted in second week of July and harvesting in second week of Nov. 2013.

The maximum yield contributing parameters, grain (7.11 t ha⁻¹) and straw (8.45 t ha⁻¹) yield were recorded in the treatment T₂: soil application of 50kg ZnSO₄ ha⁻¹ showing higher requirement of NPK (150:60:60) ha⁻¹ recommended. Whereas minimum grain (5.70 t ha⁻¹) and straw (7.00 t ha⁻¹) yield was obtained in the treatments having T₁: control. This experiment observed that T₂:soil application of 50kg ZnSO₄ ha⁻¹ significantly superior over the rest treatments.

Keywords: Application, Treatment, Growth and Yield

RESPONSE OF SOME NEW MAIZE HYBRIDS TO SOME NANO FERTILIZERS UNDER WATER STRESS CONDITIONS.

F.S. ABD EL-SAMIE¹, EKRAM, A. MEGAWER¹, H.H.M. HUSSEIN², AND SARA, M. MOHAMED¹

1. Agronomy Department, Faculty of Agriculture, Fayoum University, Egypt

2- Agronomy Department, Faculty of Agriculture, Ain Shams University, Egypt

ABSTRACT

Two field trials were conducted during the two successive summer growing seasons of 2019 and 2020, at the Experimental Farm, Faculty of Agriculture, Fayoum University Fayoum Governorate, Egypt. A split-split design with three replicates was used. The main plots were assigned three water stress treatments (skipping of some irrigations) as follows: normal irrigation (7 irrigations) i.e., control treatment, missing the 4th irrigation (64 DAP), and missing the 6th irrigation (78 DAP). The sub-plots were restricted to three yellow single cross hybrids of maize, i.e. single cross hybrid 2055, single cross hybrid 2066 and single cross hybrid 2088, and the sub-sub plots received three concentrations Calcium carbonate nanoparticles i.e. 500 g fed⁻¹, 750 g fed⁻¹ and 100 g fed⁻¹. The results showed that irrigation treatment reflected positive significant influences on growth parameters, normal irrigation resulted in the best mean values of plant height, maximum number of leaves plant⁻¹, largest leaf area plant⁻¹ and heaviest dry weight plant⁻¹ in both seasons 65 and 80 (DAS). Irrigation treatments had a significant effect on number of days from sowing to 50% tasseling in the two growing seasons. The maximum number of days from sowing to 50% tasseling due to irrigation were produced from the normal irrigation compared with the other irrigation treatments {(Withholding the 4th irrigation (64 DAP) and withholding the 5th irrigation (78 DAP)}. Results showed that yellow single cross hybrids of maize were significantly differed in almost mean values of maize growth, under study in the both seasons. Maize hybrid of S. C. 2088 was significantly surpassed S. C. 2055 and S. C. 2066 in mean values of all growth characters. Calcium carbonate nanoparticles concentrations had a significant effect on growth parameters i. e. plant height, number of leaves/plant-1, dry weight plant-1, and total dry weight of plant in both seasons at 65 and 80 DAS. Data revealed that ear characters i.e. (ear height, ear length, ear diameter, ear weight, number of row/ears, number of grain /row) significantly affected by different irrigation treatments. Normal irrigation produced the highest values. There was significant effect on ear characters i.e. (ear height, ear length, ear diameter, ear weight, number of row/ears, number of grain /row) between different yellow single cross hybrids of maize. S. C. 2088 was significantly surpassed S. C. 2055 and S. C. 2066 in mean values of all ear characters. Application of Calcium carbonate nanoparticles as nano-fertilizers was pioneer and significantly resulted in characters i.e. (ear height, ear length, ear diameter, ear weight, number of row/ears, number of grain /row), high rate of Calcium carbonate nanoparticles produced the highest values.

Keywords: Maize, Water stress, Calcium carbonate nanoparticles, yield and its components.

THERMAL PRESSURES AT HIGH TEMPERATURES ARE USED IN AU (GOLD) FOR EQUATION OF STATE (EOS)

RAKESH KUMAR,

Department of Physics, Narain College Shikohabad, Dist. Firozabad (U.P.)

ABSTRACT

The equation of state (EOS) of condensed matter is important in many fields of basic and applied sciences including physics and geophysics. To explain an equation of state (EOS) and other thermodynamical properties of a Au (Gold) are using measured data. The lattice thermal pressures at high temperatures have been estimated based on the Mie-Gruneisen-Debye type treatment with the Vinet isothermal EOS. The contribution of electronic thermal pressure at high temperature, which is relatively insignificant for Au (Gold), has also been included here. We propose the present equation of state (EOS) to be used as a reliable pressure standard for static experiments up to 3000K and 300 GPa.

ANTI-DIABETIC MEDICINAL PLANT USED IN TRADITIONAL MEDICINE

¹VIJAY KUMAR SINGH, ²MANISH KUMAR AND MANISH MAHESHWARI

¹⁻²Department of Zoology, Narain College, Shikohabad, UP

3 Department of Zoology, DS College (RMPSS University, Aligarh), Aligarh

ABSTRACT

Medicinal plants should be evaluated extensively to determine the active principles present in them that are responsible for the hypoglycemic activity of these plants. Herbal drugs have gained popularity among the general population due to their ability to treat ailments with minimum side effects. The multi-target approaches of medicinal plants make them least susceptible to failure during the treatment therapy. Medicinal plants showing prominent anti-diabetic activity during the initial studies should be further explored to identify the active principles present in them that can become the promising drug candidates for the disease treatment in the coming future. Diabetes is a type of body metabolic derangement that leads to high blood sugar level following low action or lack of insulin. Several type of antidiabetic drugs are used for treatment of high blood sugar level. But due to lack of effective treatment, dietary modification and other alternative intervention is fundamental to successful treatment of diabetes whether it is type I or II. Epidemiological evidence indicates strong correlation between the processed food diet habits and incidence of diabetes. However, the reestablishing a traditional diet and lifestyle as well as alternative treatment of diabetes may reduce the incidence and late complication of type II diabetes. Herbal preparation is used by diabetic patients in all societies even in industrialized countries especially among unsuccessfully treated patients and those who are candidate for insulin therapy. As most of the physician's advice their patients not to use herbal medicine, the diabetic patients will use it without knowledge of their physicians. This type of herbal therapy may lead to drug interaction or false and unstable blood glucose level monitoring. The present review covers advance knowledge of herbal medicine including: *Allium cepa* L., *Allium sativum* L. *Mamordica charantia* L., *Gymnema sylvestre* L., *Trigonella foenum graecum* L., *Atriplex halimus* L., *Vaccinium myrtillus* L., *Ginkgo biloba* L., *Silybum marianum* L. Gaertn., *Citrullus colocynthis* (L.) Schrad, *Securigera securidaca* L. *Camellia sinensis* L. and some flavanoids in the management of diabetes.

Keywords: Diabetes, Traditional medicine, Medicinal plant

PHYTOCHEMICAL PROFILING AND GC-MS ANALYSIS OF AQUEOUS METHANOL FRACTION OF FIELD RESISTANT SOYBEAN LEAVES EXTRACT AGAINST *Spodopetra litura* and *Spilosoma obliqua*

ANCHALA NAUTIYAL

Department of Zoology, Government Degree College, Thatyur, Tehri Garhwal (Uttarakhand)

ABSTRACT

The aim of present investigation was to analyze the bioactive compound from the leaves of field resistant genotypes of soybean against *Spodopetra litura* and *Spilosoma obliqua*. Fresh leaves of soybean genotype SL 688 were collected washed, shade dried and powdered. Methanol extract was prepared by simple soxhlation method. The extract was concentrated and analyzed using Gas Chromatography Mass Spectroscopy for the identification of biochemical components present in genotype SL 688.) data was obtained on a Shimadzu GCMS-QP-2010 plus system using AB inno-wax column (60 m × 0.25 mm id, film thickness 0.25 m).

Phytochemical screening of aqueous methanol fraction of resistant genotypes (SL 688) by GC-MS analysis revealed the presence of total 21 bioactive compounds in the sample extract based on retention time, and per cent area. It is found that out of 21 bioactive compounds the genotype SL 688 has highest amount of phenolic compound activity namely Bis (2-ethylhexyl) phthalate, Phytol, Lup-20(29)-en-3-yl acetate, 9,12,15-Octadecatrienoic acid, methyl ester, Squalene, 2h-1-benzopyran-6-ol, 2-hexadecen-1-ol, Santalol and Geranyl linalool isomer. followed by miscellaneous compounds namely 14-ethylene-14-pentadecn, 1-nonadecene, Tridecane1-heptadecene. Hence it is found that the amount of the toxic phenolic compounds in genotype SL 688 is major key factor in deterrence and its accumulation in different parts of the plant develops feeding barrier and make genotype SL 688 resistant against *Spodopetra litura* and *Spilosoma obliqua*.

Keywords: *Spodopetra litura*, *Spilosoma obliqua*, GC-MS, Phenolic compounds.

A STUDY ON COMPARISON OF COGNITIVE DEVELOPMENT OF CHILDREN ACROSS THE PLACE OF RESIDENCE

SANGEETA SIDOLA

Department of Home Science, Government Degree College, Thatyur, Tehri Garhwal, Uttarakhand

ABSTRACT

The early childhood is the time when the child is so naive and fresh and as well as so eager to learn as much as he can. The early childhood is the period when the maximum of the brain's development takes place and also the physical development of the child is at maximum. However, the rate of growth and development is different amongst the children as every child is unique and different from each other, some are fast in learning, and some need more time to learn. The reasons may be various, to take all this point under consideration the present study was planned to assess the cognitive development of the children across the place of residence. The sample comprises of the children of 3 years of age from the state Uttarakhand across rural and urban areas. The Bayley scale of infant and toddler development was used to assess the cognitive development of the respondents. The data revealed that non-significant differences were observed in cognitive development of the respondents across place of residence. However, it was observed that the children in urban areas were slightly better than the children in the rural areas. Although there were no prominent differences but the reason for the slight difference might be the atmosphere of the urban areas, it provides more of conducive and learning environment also the parents are competitive in urban areas.

Keywords: Cognitive, Rural, Urban

ZIKA VIRUS AS A GLOBAL THREAT: A SYSTEMATIC REVIEW ON CURRENT UPDATES

AMARPAL SINGH BHADAURIYA

Shankarlal Agrawal Science College Salekasa, Gondia Maharashtra, India

ABSTRACT

Zika virus is a *flaviviridae* family virus. It is an emerging disease, spread by the bite of female *Aedes* mosquitoes, primarily by *A. aegypti* but *A. albopictus* can also play a role in transmission. It can also be transmitted from mother to fetus during pregnancy, through sexual contact, breast feeding, transfusion of blood and blood products, and organ transplantation. As it was first reported from the Zika Forest of Uganda in 1947, hence it was named Zika. According to World Health Organization approximately 83 countries have reported Zika infection worldwide till date. Clinical symptoms of Zika infection vary from asymptomatic to low grade fever, conjunctivitis, maculopapular rash, headache, retro-orbital pain and arthritis/arthralgia with periarticular edema, myalgia, vertigo, vomiting and asthenia. Microcephaly in neonates is the most serious clinical symptom of suspected congenital Zika syndrome. RT-PCR is the most well-known laboratory test for Zika virus infection detection. As we all are aware that there is no certified vaccine or therapeutic medication for Zika virus infection, so prevention and control of vector can be an important asset for Zika virus infection control. As it is transmitted by the bite mosquito so vector control methods like environment management, use of biocontrol agents in public health programme, use of mosquito repellents etc., can play a crucial role in control of Zika virus infection.

Keywords: Zika, *Aedes*, *Flaviviridae*, Microcephaly

INFLUENCE OF CHEMICAL WEED MANAGEMENT PRACTICES ON NUTRIENTS UPTAKE AND YIELD OF HIGH-DENSITY PLANTING COTTON IN *VERTISOL* OF NORTHERN KARNATAKA

KAMBLE ANAND SHANKAR¹, CHANNABASAVANNA, A. S.², AJAYAKUMAR³, M. Y., AND KOPPALKAR B. G.⁴.

Department of Agronomy, College of Agriculture, University of Agricultural Sciences, Raichur-584 104, Karnataka, India

ABSTRACT

The experiment was conducted for two consecutive years 2017 and 2018 to study the efficiency of new formulation of pre-emergence herbicide clomazone 50 EC on nutrient uptake and seed cotton yield of HDPS cotton with better weed management in a cost-effective manner. Clomazone 50 EC was tried in three different doses, viz. 250, 500 and 750 g a.i. ha⁻¹ concentrations and was compared with pendimethalin 680 g a.i. ha⁻¹, post-emergence herbicides such as, pyriproxyfen sodium 10 EC and quizalofop ethyl 5 EC @, cultural; method like one HW at 25 DAS and IC at 50 and 75 DAS, weed free check, unweeded control and other integrated methods. The experiment was carried out in a randomized complete block design replicated thrice. The weed flora of the experimental field was dominated by *Cynodon dactylon*, *Rottboellia exaltata*, *Trichodesma indica*, *Commelina benghalensis*, *Digera arvensis*, *Tridax procumbens*, and *Phyllanthus niruri* etc. Significantly lower NPK uptake was recorded by weeds in weed free check (0 kg ha⁻¹ NPK) over unweeded control (42.4, 5.95, 43.3 kg NPK ha⁻¹) and rest of the treatments. With respect to other treatments, pre emergence application of pendimethalin 38.7 CS @ 680 g a.i. ha⁻¹ (9.0 kg ha⁻¹) and clomazone 50 EC @ 250 g a.i. ha⁻¹ (7.8 kg ha⁻¹) with one HW at 25 DAS and IC at 50 and 75 DAS or post emergence application

of pyriothobac sodium 10 EC @ 75 g a.i. ha⁻¹ or combined with post emergence application of pyriothobac sodium 10 EC @ 75 g a.i. ha⁻¹ + quizolofop ethyl 5 EC @ 37.5 g a.i. ha⁻¹ did not show any significant differences and were on par with each other and recorded significantly lower values over unweeded control. The seed cotton equivalent yield was higher when herbicides were used indicating no adverse effect of the herbicide.

Keywords: Pendimethalin, Clomazone, pyriothobac sodium Nutrient uptake and seed cotton

ROLE OF REMOTE SENSING AND GEOGRAPHIC INFORMATION SYSTEM IN SUSTAINABLE DEVELOPMENT

B USHASRI¹, T GIRIDHARA KRISHNA², KV NAGA MADHURI³, Y REDDIRAMU⁴ AND B RAVINDRA REDDY⁵

¹Department of Soil Science & Agricultural Chemistry, S.V. Agricultural College, Tirupati, Andhra Pradesh, India

² ANGRAU, Lam, Guntur, Andhra Pradesh, India

³Department of Soil Science & Agricultural Chemistry, Institute of Frontier Technology, RARS, Tirupati, Andhra Pradesh, India

⁴Department of Agronomy, S.V. Agricultural College, Tirupati, Andhra Pradesh, India

⁵ ITDA, Srisailam, Andhra Pradesh, India

ABSTRACT

Over exploitation of available natural resources for meeting the growing demand for food, fuel and fibre of the ceaselessly increasing population has resulted in severe environmental degradation. Globally, 1964.4x10⁶ ha land are affected by human induced degradation. Of this, 1,903x10⁶ ha are subject to soil erosion by water, 548.3x10⁶ ha to wind erosion, 239.1x10⁶ ha to chemical deterioration, 68.2x10⁶ ha to compaction and 10.5 x 10⁶ ha to waterlogging (UNEP, 1993). Rapid industrialization coupled with the deforestation has led to release of greenhouse gases in the atmosphere resulting in global warming. Thus, it is clear that the environmental degradation process unless detected early and action taken to arrest or mitigate may lead to further deterioration and may affect sustainable development efforts. Sustainable development of natural resources refers to maintaining a brittle balance between productivity functions and conservation practices through identification and monitoring of problem areas and calls for optimal utilization of available natural resources based on their potentials and limitations while maintaining a good harmony with the environment. Information on the nature, extent, spatial distribution along with the potentials and limitations of natural resources is a pre-requisite to achieve the goals of sustainable development. By virtue of providing synoptic view of fairly large area at a regular interval spaceborne multispectral measurements hold great promise in generating reliable, information on various natural resources, namely soils, mineral, surface and ground water, forest cover, marine resources, in a timely and cost-effective manner. Geographic Information System (GIS) offers an ideal environment for integrating spatial and attribute data on natural resources and environment, and for subsequent generation of optimal land use plan on a micro-watershed basis. Furthermore, Global Positioning System (GPS) enables making precise insitu measurements on various terrain parameters which are used for both generating baseline as well as derivative information on natural resources for various developmental activities. Advancements in weather forecasting and tele-communication further help in effective implementation of optimal land use plans/action plans. Applications of different remote sensing techniques are important for crop monitoring, crop condition assessment and yield estimation for sustainability of agriculture and natural resources.

Keywords: Geographical Information System, Global Positioning System, Remote sensing, Sustainability

INFLUENCE OF BIO-PRIMING ON SEED QUALITY OF CHILLI (*Capsicum annuum* L.)

KISHORKUMAR, G. K¹, RAVEENDRA JAWADAGI², SHIVAYOGI RYAVALAD³,
^{1,2}Department of Vegetable Science, College of Horticulture, Bagalkot, Karnataka, India
³Seed Unit, UHS, Bagalkot-587 104, Karnataka

ABSTRACT

Chilli (*Capsicum annuum* L.) is an important spice crop of India and the quality of its seed is an important commercial trait. However, the quality of the seeds is lost if they are stored for the months between harvest and the subsequent sowing. The seeds of Rudra and Byadgi Dabbi varieties were subjected to bio-priming with the *Pseudomonas fluorescens*, *Bacillus* and *Trichoderma viride* on qualitative parameters. The culture of *Pseudomonas fluorescens*, *Bacillus* and *Trichoderma viride* at 2.5g and 5.0g concentration were used as pre-sowing bio-priming treatments. Bio-priming influenced significantly on the capability of the chilli seedlings with the highest germination percentage of 98.69% (2.5 g *P. fluorescens*, T₁), shoot length 6.53cm (5 g *P. fluorescens*, T₂), root length 7.18cm (5 g *T. viride*, T₆), seedling length 13.43 cm (5 g *P. fluorescens*, T₂) and seedling vigour index 1216.44 (5 g *P. fluorescens*, T₂) in Byadgi Dabbi cultivar and where as in Rudra cultivar recorded germination percentage of 99.75% (T₂), shoot length 4.13cm (5 g *T. viride*, T₆), root length 7.38cm (5 g *T. viride*, T₆), seedling length 11.56 cm (5 g *T. viride*, T₆) and seedling vigour index 1140.12 (5 g *T. viride*, T₆) when compared with control. Therefore, bio-priming with *Pseudomonas fluorescens*, *Bacillus* and *Trichoderma viride* are effective in enhancing the seed quality of chilli.

Keywords: Bio-priming, *Pseudomonas fluorescens*, *Trichoderma viride*, *Bacillus*, Chilli

QUANTITATIVE ANALYSIS OF ESSENTIAL INGREDIENTS, NUTRACEUTICAL, AND TRACE ELEMENTS IN HERBAL INFUSION

C. S. SANWAL¹, *A.K. BHANDARI¹, RAKESH BISHT¹, NARAYAN SINGH², M. BAUNTHIYAL³

¹Herbal Research and Development Institute, Mandal Gopeshwar, Chamoli (246401), Uttarakhand, India

²The Energy and Resources Institute (TERI), Latey Bunga, Mukteshwar, Nainital - 263 132, Uttarakhand

³G.B. Pant Institute of Engineering and Technology Pauri-Garhwal (246194), Uttarakhand, India

ABSTRACT

Herbal tea is also known as herbal infusion essentially made up of leaves, flowers, fruit, seeds, and/ or roots of various plant materials which does not have caffeine content. Herbal teas are usually mixtures of multiple ingredients, having prominent dietary sources of polyphenols which have a variety of health benefits. Several kinds of herbal teas have been used for their medicinal properties and some of them are being consumed for their energizing properties to help induce relaxation, curb stomach or digestive problems and also strengthen the immune system due to the presence of antioxidants. The study aimed to perform nutritional, phytochemical, and sensory analysis and assess the potential of herbal formulation made up of various herbs in possessing phytochemical contents and to be a part of herbal tea development. We developed six types of herbal teas, which are pre-dominantly contain proteins (12.49-22.05%), Energy (320-342 Kcal/100gm.), Tannins (2.22-5.67%), Vitamin C (0.20-0.85 mg/100gm.), Crude fiber (13.75-15.50%), Iron (0.10-0.85 mg/100gm), Copper (9.01-17.33)

and Zink (16.94-42.45 mg/Kg). As part of nutritional analysis, tests such as moisture content, ash content, and mineral composition of the herbal formulation mixture were also performed. Formulation of all six herbal teas sensory analysis was performed to validate the aroma, color, astringency, flavor, and overall acceptability parameters in herbal tea. The results of the nutritional and phytochemical showed that the formulation mixture of herbs is an excellent source of Nutraceutical and vitamins with high therapeutical importance. Herbal Teas are commonly consumed for their therapeutic and energizing properties since they can help to induce relaxation. Intend of this study was to develop the formula for different herbal teas and to encourage farmers to take up the cultivation of herbs so that they can enhance their livelihood and society can benefit from it.

Keywords: *Herbal tea, Phytochemicals, Nutraceutical, Vitamin*

AGROFORESTRY SYSTEMS FOR ENHANCING RESOURCE USE EFFICIENCY AND PRODUCTIVITY IN SEMI-ARID AREAS

N. KAUSHIK* AND KAJAL MEHTA

CCS HAU College of Agriculture, Bawal-123501, Rewari, Haryana (India)

More than 6.09 billion ha land of land is under arid and semi-arid region and supports the livelihood of 35% world population. To meet the rising demands for food and other ecosystem services of rapidly growing population is a major challenge in this area. In the last three decades, agroforestry has been widely promoted in the tropics as a natural resource management strategy that attempts to balance the goals of agricultural development with the conservation of soils, water, local and regional climate, and biodiversity (Schroth *et al.* 2004). Planting of trees with agricultural crops has been found economically viable and environment friendly by several researchers. The potential of agroforestry to provide alternate sources of income and employment to the rural poor also has been highlighted (Kaushik *et al.*, 2017). Woody perennial-based production systems, such as agroforestry, have the potential to sequester large quantities of CO₂ and thereby partially offset the global warming process.

Agroforestry has been part of ways to improve and conserve the natural resources and an adaptation to climatic change in dry regions and are more efficient in providing ecosystem services (regulating, supporting and cultural) as compared to other land use systems. All forms of agroforestry/systems of management may not be of general relevance, but the options available from the traditional practices enable their manipulation to meet location-specific requirements. Policy and institutional support to augment production through agroforestry research and development are lacking. Therefore, performance of various agroforestry systems was studied in semi-arid part of North-West India to enhance the productivity and resilience under climate change

Methodology

Different agroforestry systems were developed at Chaudhary Charan Singh Haryana Agricultural University Regional Research Station, Bawal, located in the low rainfall zone of the southern Haryana (28.1° N, 76.5° E and 266 m above mean sea level). The following agroforestry systems were studied

1. Agri-silviculture system

a). *Prosopis cineraria* (Khejri) based Agroforestry model:

The experiment was conducted in 20 years old trees of *Prosopis cineraria* planted at a spacing of 6 x 5 m. with field crops three cowpea (*Vigna unguiculata*), clusterbean (*Cyamopsis tetragonoloba*) and perlmillet (*Pennisetum americanum*)..

b). *Ailanthus excelsa* based model

The experimentation was done with *A. excelsa* planted at four spacing i.e. 10x20; 10x10; 10x6.5 and 10x5 m intercropped with crop sequences viz., pearl millet (*Pennisetum americanum* (L.) R. Br) – Indian mustard (*Brassica juncea*), cluster bean (*Cyamopsis tetragonoloba*) Taub) - wheat (*Triticum aestivum*).

2. Agri-silvi-horticulture system

The combinations of different tree species namely shisham (*Dalbergia sissoo*) + aonla (*Embilica officinalis*), shisham (*Dalbergia sissoo*) + guava (*Psidium guajava*), khejri (*Prosopis cineraria*) + aonla (*Embilica officinalis*) and khejri (*Prosopis cineraria*) + guava (*Psidium guajava*) were planted at a spacing of 6 x 6m. After establishment of trees the crop sequences viz., ridgegourd (*Luffa acutangula*)- tomato (*Lycopersicon esculentum*), moongbean (*Vigna radiata*) - fallow and clusterbean (*Cyamopsis tetragonoloba*) - fallow were raised in the interspaces of the trees.

Treatments comprised of four silvihorticulture systems i.e. *Dalbergia sissoo*, + *Morus alba*, *D. sissoo*+ *Embilica officinalis*, *Azadirachta indica* + *E. officinalis* and *Azadirachta indica* + *Morus alba* in 2:1 ratio and four crops i.e. pearl millet (*Pennisetum americanum*) and clusterbean (*Cyamopsis tetragonoloba*) in Kharif and Raya (*Brassica juncea*) and chickpea (*Cicer arietinum*) in Rabi.

Silvipastoral

The treatments comprised of three top-feed tree species, namely, *Cholophospermum mopane* (Mopane), *Acacia bivenosa* and *Hardwickia binnata* (Anjan tree) alongwith control (no tree) and five fodder crops: pearl millet (*Pennisetum americanum*) cowpea (*Vigna unguiculata*), buffel grass (*Cenchrus ciliaris*), pearl millet + cowpea (2:1) buffel grass + cowpea (2:1).

Results

In general, all agroforestry systems were found more productive and economic when compared with sole cropping of arable crops, however yield reduction was noticed with the maturity of the system. The summary of results is given as under:

Prosopis cineraria (Khejri) based Agroforestry model: The fodder yield was maximum in pearl millet and minimum in buffel grass when the fodder crops were grown either sole or in association with trees. The average increase in yield of green fodder due to canopy cover of the *Prosopis* trees was of the order of 24.1%, 25.4% and 12.3% in cowpea, pearl millet and clusterbean, respectively.

Ailanthus excels based model: The silvoarable system of *Mahaneem* + Indian mustard with plant geometry of 10x5 m was found most remunerative, as the maximum net returns (Rs.100,140 ha⁻¹) and benefit to cost ratio (2.84) were observed with this system. Biomass of 28.6 t ha⁻¹ from trees and 5.9 t ha⁻¹ from wheat (only straw and underground) under 5x4m geometry can be potential feedstock for biofuel production on sustainable basis.

Agri-silvi-horticulture system: There was appreciable build up in soil organic carbon content and decrease in soil pH under agri-silvi-horti systems as compared to sole cropping. The available NPK content also increased under agri-silvi-horti systems and decreased with increasing soil depth. The agri-silvi-horti system of khejri + guava + clusterbean – barley fetched higher net returns (Rs. 76,650 ha⁻¹), while the net returns from sole cropping of clusterbean - barley was only Rs. 15, 953ha⁻¹.

Conclusion: The results showed that agroforestry systems may ecologically advantageously land use system for food and biomass production on sustainable basis. Increased productivity was observed under agroforestry systems. The agroforestry systems were economical as compared to sole cropping. Agroforestry systems had positive effect on soil fertility (OM, available P and K) as compared to sole cropping and with the advancement of age of trees soil health is anticipated to be further benefited. The pattern of resource use and system productivity may also change with maturity of trees.

References

- Kaushik N, Tikkoo A, Yadav PK, Deswal RPS, Singh S. 2017. Agri-silvi-horti systems for semi- arid regions of North-West India. *Agric Res.*6 (2):150 -158.
- Schroth G, Fonseca GAB, Harvey CA, Gascon C, Vasconcelos HL, Izac AMN. 2004. Agroforestry and biodiversity conservation in tropical landscapes. Island Press, Washington, p 523.

BETA-GLUCAN FROM EDIBLE MUSHROOMS AS FUNCTIONAL BIOMATERIAL

SUHANI SAJAD* AND JAGMOHAN SINGH

Department of Food Science & Technology, Sher-e-Kashmir University of Agricultural Sciences & Technology of Jammu, 180009, India

ABSTRACT

Edible mushrooms are important constituents of our daily diet due to their rich nutrition and beneficial properties for human health. Polysaccharides, the main component of edible mushrooms, attracted more and more attention because of their complex structure and diverse biological activities. Health-promoting β -glucans are an auspicious group of polysaccharides. β -glucans are major bioactive compounds known to have biological activities including anti-cancer, anti-inflammatory, and immune-modulating properties. β -glucans from different sources such as cereals, yeast and grass have previously been documented. However, information on mushroom β -glucan is limited. They have been widely regarded as a natural source for functional foods and pharmaceuticals. Due to the specific physical properties of β -glucans, such as water solubility, viscosity, and gelation, it has been increasingly used by the food and other industries. However, the physico-chemically stable and biocompatible properties of β -glucans are rarely explored as a coating material for nanomaterials to overcome the problems of aggregation and cytotoxicity. The aim of this review article is to present an overview on the exploration of β -glucans, in particular those derived from mushrooms, as a natural coating material to modify the surface properties of bioactive substances as a relatively simple and cost-effective strategy to produce stable and biocompatible nanohybrids used for biopharmaceutical use. It is envisaged that such β -glucan based coating method will provide new opportunities to design biocompatible functional nanomaterials for wider clinical applications. Furthermore, the physicochemical properties, chemical modifications, possible industrial applications and future prospects of β -glucans in foods, medicines and other potential value-added products are also summarized.

Keywords: β -Glucan, Functional food, Biocompatibility, Pharmaceutical, Industrial application.

EFFECT OF FEEDING HYDROPONIC HORSEGRAM SPROUTS ON GROWTH PERFORMANCE OF KONKAN KANYAL GOATS

DIVYA KOKANI^{1*}, B. G. DESAI², D. J. BHAGAT², V. S. DANDEKAR³, J. S. DHEKALE³

Department of Animal Husbandry and Dairy Science, College Of Agriculture Dapoli,
DR. Balasaheb Sawant Konkan Krishi Vidyapeeth Dapoli, Dist-Ratnagiri, Maharashtra,
India.

ABSTRACT

An experiment was conducted to study the effect of feeding hydroponic horse gram sprouts on growth performance of goats. Twenty Konkan Kanyal goats (4 to 6 months old) were divided into four groups and fed hydroponic horse gram sprouts *viz.*, T₁ (0%), T₂ (15%), T₃ (30%) and T₄ (45%). The result of study showed that daily dry matter intake was significantly ($p < 0.05$) higher in T₃ (667.02g) than T₁ (619.36g), T₂ (654.73), T₃ (663.59g). Digestible crude protein (g/d) and metabolizable energy (MJ/d) intake of kids was 38.28 and 4.32 in T₁, 38.36 and 4.50 in T₂, 38.50 and 4.54 in T₃ and 38.73 and 4.77 in T₄ respectively. Average daily gain was higher in T₃ (91.24g) than T₁ (85.73g), T₂ (90.89g) and T₄ (90.19g). The feed cost per kg live weight gain (Rs) was 50.71 in T₁, 65.68 in T₂, 81.97 in T₃ and 85.23 in T₄. Therefore, it is concluded that 15% horse gram sprouts with 85% basal feed found beneficial for higher growth performance and economic profitability in goats.

EFFECT OF GIBBERELIC ACID ON MYCELIAL GROWTH OF *Hericum erinaceus*

STANZIN DISKIT¹, SACHIN GUPTA¹ AND MONI GUPTA²

Division of Plant Pathology, Division of Biochemistry, Sher-e-Kashmir University of
Agricultural Sciences and Technology Jammu

ABSTRACT

The edible and therapeutic lion's mane mushroom is a member of the basidiomycete family. It is indigenous to Asia, Europe, and North America. It normally grows on forest wood, but recently there has been a trend to cultivate it on sterilised substrates in order to improve productivity and shorten the length of its culture cycle. To investigate the impact of various gibberellic acid (GA) concentrations on the mycelial proliferation of *Hericum erinaceus* on different media, an experiment was conducted. At 12 days following inoculation, malt extract agar (MEA) medium supplemented with 30 ppm (GA) produced the highest mycelial growth of 8.50 cm and the lowest of 6.70 cm (DAI), while at 12DAI, potato dextrose agar with 30 ppm (GA) added produced the highest mycelial growth of 9.60 cm and the lowest of 6.80 cm. In the case of sawdust extract, agar medium supplemented with 30 ppm (GA) produced the highest mycelial growth of 6.80 cm and the lowest one of 4.50 cm with 10 ppm at 12 DAI, while wheat straw extract, agar medium supplemented with 30 ppm, produced the highest mycelial growth of 5.60 cm and the lowest one of 3.50 cm with 10 ppm at 12 DAI. In rices straw extract agar media, 30 ppm produced the highest mycelial growth of 5.20 cm and 10 ppm produced the lowest growth of 3.40 cm at 12 DAI. The lowest mycelial colony measured 3.40 cm with 10 ppm on rice straw extract agar media at 12 DAI, while the highest, measuring 9.60 cm, was discovered at 30 ppm in potato dextrose agar. 30 ppm outperformed the other two concentrations in terms of *Hericum erinaceus* mycelial colony proliferation.

Keywords: Gibberellic acid, *Hericum erinaceus*, mycelial growth.

RESPONSE OF BUD INDUCTION IN PINEAPPLE OVER APPLIED PLANT BIOREGULATORS

AFIYA R S* AND SENTHILKUMAR S

Department of Horticulture, Central University of Tamilnadu

ABSTRACT

Large scale commercial production and expansion is a major limiting problem in pineapple (*Ananas comosus*) due to the difficulty in obtaining large quantity of quality planting materials and also due to slow rate of multiplication by conventional methods. To overcome this problem an investigation was carried out in pineapple var. Mauritius for rapid multiplication using stem sectioning technique (non-conventional technique). Efficiency of stem sections to produce more propagules and its response to plant growth promoters were analyzed using two factors such as types of stems cutting (whole stem cutting, half stem cutting, sliced stem cutting and longitudinal stem cutting) and growth promoters (IBA, coconut water, chitosan, tetracycline) having twenty combinations replicated twice. Better performance of bud emergence, plantlet production, morphological characters and growth analysis shown by S₁ ‘whole stem cuttings’ followed by S₄ ‘longitudinal stem cuttings. More carbohydrate reserves in whole stem cuttings and longitudinal cuttings fastened the rate of bud emergence and production of more vigorous plantlets. As growth promoter best results were produced by G₂ ‘coconut water’ in early bud emergence as well as sprouting, dormancy breaking of more axillary buds and significant differences in other morphological characters were observed. Coconut water contains growth hormones such as auxin, cytokinin helps in cell division and cell elongation further helps in production of more plantlets. With regard to interactions Whole stem cuttings with coconut water performed better with bud growth and plantlet production but with regard to growth analysis more vigorous shoots with more weight and height was shown by cutting without treatment. Therefore, for fast and rapid multiplication of pineapple plantlets stem sectioning can be adopted commercially by farmers.

Keywords: Pineapple, stem section, growth promoters, hydroponics

CLIMATE CHANGE AND MICROORGANISMS IN AGROECOSYSTEMS.

THOKCHOM DORENCHAND SINGH

Soil Science & Agricultural chemistry, CPGS-AS, Umiam, Meghalaya-793103

ABSTRACT

Global warming and climate change are the most prominent issues of the current environmental scenario. These problems arise due to higher concentration of greenhouse gases in the atmosphere which exert a warming effect. Although much attention has been given to anthropogenic sources and impacts of these gases, the significance and implications of microorganisms have remained neglected. Microbial processes have a central role in the global fluxes of the key biogenic greenhouse gases (carbon dioxide, methane and nitrous oxide) and are likely to respond rapidly to climate change. Microorganisms are ubiquitous in nature and exhibit great diversity in various ecosystems. They are necessary for all life on the earth, because they perform many important functions, for example, nutrient recycling, crop fertility, detoxification of pollutants, regulation of carbon storage, production and absorption of greenhouse gases such as methane and nitrogen oxides. Climate change can have a significant impact on the abundance, diversity, and activity of microorganisms, which is often associated with the loss of soil carbon, changes in the level of greenhouse gases in the environment. Agricultural soils can constitute either a net source or sink of the three principal greenhouse gases, carbon dioxide (CO₂), nitrous oxide (N₂O), and methane (CH₄). Thus, microbes should never be deprived of their due importance in climate change models.

Keywords: Global warming, climate change, microorganisms, carbon-dioxide, agriculture.

PERFORMANCE AND EVALUATION OF DIFFERENT TREE SPECIES UNDER AGRI-SILVICULTURE

P. D. RAUT, V. M. ILORKAR AND AARTI DESHMUKH
AICRP on Agroforestry, Dr. PDKV, Akola

Purpose

One of the most important objectives of agroforestry is the conservation of biodiversity and its suitable utilization. Citrus is a major cash crop in the region. Nagpur oranges are known for its test and quality. The oranges produced in the region are sold in mandis, packed and transported to various part of the country for marketing. Packing of oranges, vegetables, flowers require wooden boxes. Earlier these boxes were made from the wood of mango, kadunim and savari. The local traditional mango plantations have been slaughter for the purpose. This has forced now to cut any tree like babul, palas growing on farm. *Ailanthus excelsa* being a producing soft wood, fast growing, strong copier, having a option for growing under agroforestry offers. Therefore the experiment was planted to study the potential role of Maharukh (*Ailanthus excelsa*) in agroforestry.

Methods

Ailanthus excelsa was planted at spacing 5 m x 5 m along with tree species *Tectona grandis*, *Acacia albida*. Crops like cowpea in kharif and mustard in rabi were grown in the interspaces. The study was carried out with the objectives 1) To assess growth performance of different Multi-Purpose Tree Species and 2) To find out suitable fast growing tree species for Agroforestry. The experiment was planted during 1999 in Randomized Block Design with 07 replication.

Results

Height (m): Among MPTS, *Ailanthus excelsa* attained maximum plant height (14.00 m) followed by tree

species *Tectona grandis* and *Faderbia albida*.

GBH (cm): Among MPTS, *Ailanthus excelsa* attained maximum GBH (116.43 cm) followed by tree species

Tectona grandis and *Faderbia albida*.

Grain and Straw yield (q ha⁻¹): Maximum grain and straw yield of cowpea was recorded under *Ailanthus excelsa* i.e. 4.72 and 9.21 q ha⁻¹, respectively. The cowpea grain yield in *Ailanthus excelsa*+ Cowpea agroforestry system was 68.22 and 28.38 % higher over *Tectona grandis* + Cowpea and *Faderbia*+ Cowpea agroforestry system, respectively. Maximum grain (7.85 q ha⁻¹) and straw yield (14.95 qha⁻¹) of mustard was recorded under *Ailanthus excelsa* followed by *Federbia albida*.

Tree volume (m³ ha⁻¹): Maximum volume tree⁻¹ (1.186 m³), volume ha⁻¹ (474.45 m³ ha⁻¹) were recorded under *Ailanthus excelsa* followed by *Tectona grandis* and *Federbia albida*.

Above ground, below ground and Total biomass (t ha⁻¹): Maximum above ground biomass (227.73 t ha⁻¹), below ground biomass (59.21 t ha⁻¹) and total biomass (286.95 t ha⁻¹) were recorded under *Ailanthus excelsa* followed by *Tectona grandis* and *Federbia albida*.

Above ground, below ground and Total carbon sequestration (t ha⁻¹): Maximum above ground carbon (113.87 t ha⁻¹), below ground carbon (29.61 t ha⁻¹) and total carbon sequestered (143.47 t ha⁻¹) were recorded under *Ailanthus excelsa* followed by *Tectona grandis* and *Federbia albida*.

% Increase in height, GBH and Total carbon sequestration: The percent increase in plant height (30.64 and 25.71), GBH (29.45) and total carbon sequestration was (53.95 and 37.32) in *Ailanthus excelsa* over *Tectona grandis* over *Federbia albida*.

Conclusions

From the result it is concluded that the *Ailanthus excelsa* is performing better in respect of Girth, Height, Volume ha⁻¹, above ground biomass, below ground biomass, total biomass, above ground, below ground and total carbon sequestration. The highest cow pea and mustard grain yield was recorded in *Ailanthus excelsa* (4.72 qha⁻¹ and 7.85 qha⁻¹)

Key words: *Ailanthus excelsa*, *Federbia albida*, *Tectona grandis*, Agrisilviculture system

WOODY SPECIES DIVERSITY, STRUCTURE AND REGENERATION STATUS OF SETEMA NATURAL FOREST, SETEMA DISTRICT, WESTERN ETHIOPIA

BEKELE TULU BAYESSA

Department of Natural Resources Management, Assosa University, Ethiopia

ABSTRACT

This study was conducted on Setema Natural Forest, located in Setema District, Jimma Zone, Oromia National Regional State in Southwestern Ethiopia. The objective of the study was to assess the woody species diversity, structure and regeneration status of the forest. To collect the vegetation data, eight transects were laid with regular interval of 200m distance. Along each transect, plots of 20×20 (400m²) were systematically established at 25m interval (elevation). A total of 47 species belonging to 44 genera and 31 families were recorded and identified. Fabaceae was the most dominant family represented by six species followed by Rubaceae represented by five species and Euphorbiaceae represented by three species. The basal area of the forest was 50.7 m²ha⁻¹. The total IVI of all woody trees/shrubs in the forest was 295.57, of which; *Cordia africana* contributed 43.85 IVI (14.8%) making it the most ecologically important species in the forest. Six plant communities namely: - *Schefflera abyssinica* – *Podocarpus falcatus* Community type, *Ficus sur* – *Syzium guinense* Community type, *Cordia africana* – *Albizia schimperiana* Community type, *Clausena anisata* – *Apodytes dimidiata* Community type, *Prunus Africana* *Milletia ferruginea* Community type and *Polyscias fulva* - *Ficus sycomorus* Community type were identified. The densities for seedlings, saplings and mature woody tree/shrub were 1713.95, 1166.42 and 1628 individual's ha⁻¹ respectively. The regeneration status and population structure of the forest indicated that there are human-induced disturbances in the area and immediate conservation actions should be implemented.

Keywords – Setema Natural Forest, Woody Species Composition, Regeneration.

ASSESSMENT OF HISTORICAL SPATIO-TEMPORAL VARIABILITY IN RAINFALL AND DROUGHT OF KALYAN-KARNATAKA REGION, KARNATAKA, INDIA

J. B. KAMBALE¹ AND D. BASAVARAJA²

1. Department of Soil and Water Engineering, College of Agricultural Engineering, University of Agricultural Sciences, Raichur-585104, India

Corresponding E-mail: jbkambale@gmail.com.

3. Department of Environmental Science and Agroforestry, College of Agriculture, Bheemaranagudi, University of Agricultural Sciences, Raichur-585104, India

ABSTRACT

Meteorological drought assessment relies heavily on rainfall data to determine climate and water supply trends, which in turn helps identify the likelihood of drought as well as the severity it will have. When precipitation is lower than the average, there is a drought.

Precipitation falls short of meeting human needs when this occurrence lasts for an extended length of time. With the use of Standardized Precipitation Index (SPI), we looked at long-term spatial and temporal variability of rainfall and its trend, as well as meteorological dryness in the research region. Non-parametric methods such as the Mann-Kendall test, Sen's slope estimator, and the Standardized Precipitation Index were used to evaluate rainfall data from thirty-one meteorological stations for the period 1960-2014. The rainfall variability maps were created using ArcGIS V.xx. The study's trend analysis shows both a positive and a negative tendency. The research also discloses the total yearly rainfall observed across the study region in the previous 55 years, which was geographically dispersed between 656.25 millimetres and 842.60 millimetres. Taluk wise precipitation data were analysed for meteorological drought and showed a severe dryness and the severity of that situation. Kalyan Karnataka region agricultural productivity in Karnataka state is heavily reliant on rainfall and the frequency of meteorological droughts in the Karnataka.

Keywords: Meteorological Drought, SPI, Mann-Kendall test, Sen's slope estimator

CHARACTERIZATION OF WILD POMEGRANATE AN: OVERVIEW

SAFINA KOSSER*¹ AND DEEP JI BHAT¹

¹Division of Fruit Science Skuast Jammu Chatha

ABSTRACT

Wild pomegranate (*Punica granatum* L.) commonly known as Daru belongs to family Punicaceae which has single genus *Punica* and two species *P. protopunica* Balf and the cultivated *P. Granatum*. Wild pomegranate fruits have been noted with much smaller arils, thicker rinds, and higher acidity than cultivated ones (Kher, 1999). In recent years, the demand for its value-added products got increased due to its recognition as a great source of natural antioxidants and health-promoting constituents like organic acids, anthocyanins, phenolics, vitamins, and minerals (Thakur *et al.*, 2010). Wild pomegranates are characterized by different types of phytonutrients in the form of anthocyanins, phenolics, and flavonoids that impart antioxidant properties in addition to colour (Sharma and Thakur, 2016). The bioactive components are mainly concentrated in the juicy arils of the fruit and the presence of a sufficient amount of the organic acids, vitamins, and minerals have led to categorize it as a functional food with nutraceutical properties. Identifying and preserving genetic diversity is an important factor in any crop improvement program. Identifying and preserving genetic diversity is an important factor in any crop improvement program. Germplasm improvement program in pomegranate was based on morpho-chemical and molecular characterization. Morphological and biochemical analysis provide basic information to compare genotypes for breeding to evaluate growth under different climatic conditions. High level of variation in fruit weight, length, seed weight, rind weight, acidity and TSS was recorded in wild pomegranate genotypes (Ercisli *et al.*, 2007, Bakshi *et al.*, 2014). Finding and utilization of diverse pomegranate genotypes are prime concern for pomegranate for use in breeding and to identify their desirable fruit and yield characteristics. These morphological traits are the primary markers utilized in germplasm management (Karimi *et al.*, 2008). In addition to morphological and biochemical studies, molecular analysis is used for characterization and cultivar improvement through qualitative trait linked analysis because the expression of these characteristics is not always consistent, so morphological information alone is inadequate for evaluating the genetic diversity.

Key words: Wild pomegranate, antioxidants, genetic diversity, crop improvement and germplasm management

EFFECT OF C/N RATIO LEVELS AND STOCKING DENSITY OF CATLA SPAWN (*Gibelion catla*) ON WATER QUALITY, GROWTH PERFORMANCE AND BIOFLOC NUTRITIONAL COMPOSITION IN INDOOR BIOFLOC SYSTEM

SONIA SOLANKI*, S. J. MESHAM, H. B. DHAMAGAYE, S. D. NAIK, P.E. SHINGARE, B. M. YADAV

Purpose:

Biofloc technology (BFT) is studied for its application in nurseries as an additional feed source for postlarvae. The technology improves improve water quality to support a better larval survival and growth. So, the aim of the study was to observe the growth performance of *Gibelion catla* spawn in indoor biofloc system at varying C/N ratio and stocking densities.

Methods

A 20- days 3*3 factorial experiment was conducted in 100 L HDPE experimental tanks to investigate the effect of C/N ratio (10, 15 and 20) and stocking density (3, 4 and 5 spawn L⁻¹) on *Gibelion catla* spawn nursery rearing in indoor biofloc system. Rice bran was used as the carbohydrate source for manipulating C/N ratio. Each treatment was stocked with catla spawn of average length (6.7 mm) and average weight (1.6 mg).

Results

Water parameters showed that, increasing C/N ratio from 10 to 20 significantly ($p < 0.05$) reduced total ammonia nitrogen (TAN), nitrite-nitrogen (NO₂-N) and increased nitrate-nitrogen (NO₃- N) in the water. The insignificant difference ($p > 0.05$) and lowest final average length, length gain, average weight gain and specific growth rate (SGR) were recorded at C/N ratio of 10 and 15 compared to C/N ratio of 20. Significant difference ($p < 0.05$) in survival was observed with increasing C/N ratio. Increasing the fish density resulted in higher mortality. However, higher number of fry produced was observed in the treatments with 3 and 4 spawn L⁻¹. Crude protein content increased significantly ($p < 0.05$) with increasing C/N ratio with higher content in C/N 20. No significant difference ($p > 0.05$) in proximate composition of biofloc was observed in different stocking densities groups.

Conclusion

The application of biofloc technology with C/N ratio of 20 at a density of 4 spawn L⁻¹ could be recommended to increase the production and profitability of catla spawn in indoor biofloc system.

BEE ATTRACTANTS FOR ENHANCING FRUITING BEHAVIOUR IN KIWIFRUIT

N C SHARMA, LANDI JAILYANG, PRIYANKA CHAUHAN* AND TANZIN LADON
Department of Fruit Science, Dr Y S Parmar University of Horticulture and University,
Nauni, Solan, Himachal Pradesh, India 173230

Purpose

To study the comparative performance of commercial and indigenous bee attractants against hand pollination to improve fruit set, fruit size and quality of kiwifruit (*Actinidia deliciosa* A. Chev.) cv. Monty.

Methods

The studies were carried during 2018-19 in the Experimental Kiwifruit Block of the Department of Fruit Science, Dr. Y.S. Parmar University of Horticulture and Forestry, Nauni, Solan. The experiment was laid out in a Randomized Block Design with seven treatments viz., Jaggery solution (10%), Sugar solution (10%), Honey solution (10%), Sugarcane juice (10%), Bee Scent (1.25%), Hand Pollination and Control (water spray) and each treatment was

replicated thrice. Bee attractants were applied as foliar sprays at 5 and 50 per cent flowering. The observations were recorded on fruit set, fruit size, weight and bio-chemical fruit quality characteristics as per standard procedures.

Results

The results of the study revealed that all the bee attractants had significant effects on fruit set, yield attributing characteristics and fruit quality characteristics. Among the different treatments used, Bee Scent (1.25%) spray resulted in maximum fruit set (86.12%), yield (9.59 kg/vine), fruit length (66.50 mm), diameter (46.02 mm), fruit weight (68.75 g), number of seeds/fruit (597.16), TSS (12.20°B), total sugars (5.47%) and ascorbic acid content (60.50 mg/100 g), whereas, it had minimum proportion of ‘C’ grade fruits (29.77%) and titratable acidity (1.15%). Bee Scent treatment demonstrated a substantial increase in the fruit set, yield, number of seeds per fruit, fruit length, diameter, weight, TSS and total sugars by 35.69, 25.20, 38.45, 20.25, 11.13, 14.45, 15.53 and 14.92 per cent, respectively over control. Jaggery solution (10%) was found subsequent to Bee Scent (1.25%) to improve the fruit set, yield and fruit quality attributes of kiwifruit.

Conclusion

The commercial bee attractant Bee Scent (1.25%) and local bee attractant Jaggery solution (10%) have conveyed the prospect to be used in commercial kiwifruit production system as a suitable substitute for laborious practice of hand pollination.

Keywords: Kiwifruit, Bee attractant, Bee Scent, Fruit set, Yield and Fruit quality

AGROFORESTRY AS A STRATEGY FOR CARBON SEQUESTRATION AND CARBON TRADING

MANJOT SINGH SIDHU AND K. K. SOOD

Division of Agroforestry, Sher-e-Kashmir University of Agricultural Sciences and Technology, Jammu-180009

ABSTRACT

Atmospheric carbon dioxide constitutes about 76% of total GHGs and is responsible for 60% of the enhanced greenhouse effect, leading to climate change. Due to various human activities, its concentration in atmosphere has increased from 285 ppm at the end of the 19th century to about 395 ppm in the new millennium. Currently, India ranks 3rd in carbon emission, with annual emission of 2.88 Gt which constitute 6.8% of the world. This carbon can be sequestered for long term in terrestrial biosphere, underground or in oceans. Among these, agroforestry could be better option for sequestering carbon because of environmental and economic benefits. Beside this agroforestry also contribute half of the demand of wood, two third of small timber, 70-80 % wood for plywood. Under the scheme of REDD+, agroforestry also provides the opportunity to enter into carbon market through trade of carbon credits. India is emerging serious player in carbon trading market and expected to play crucial part in delivering climate ambition through the carbon market mechanism. At the same time, agroforestry as a strategy for carbon sequestration in Indian scenario has many bottlenecks for example there are mostly small and marginal farmers having low literacy rate hence, they do not have knowledge of carbon market. Absence of agro-forester’s co-operatives and weak institutional capabilities of forest department are some other hurdles which needs to be crossed.

Keywords: Agroforestry, Carbon Sequestration, Carbon Trading and Climate Change

SCENT-MARKING OF AFRICAN CIVET (*Civettictis civetta*, Schreber, 1776) IN ARIDITY FOREST, WESTERN ETHIOPIA.

DESSALEW SHITU AYENE AND BEKELE TULU BAYISSA

Department of Natural Resource Management, Assosa University, College of Agriculture and Natural Resources

ABSTRACT

The civetry sites of African Civet were investigated in the Aridstey forest Western Ethiopia during August 2017-January 2018. The civetry sites were identified and the scent marking sites were also located. The scent markings were at the height of 32-39 cm above the ground and the civets scent marked mostly on *Eucalyptus* sp., *Clausenia anisata*, and *Capsicum annum* in the present study area.

QUANTITATIVE ANALYSIS OF ESSENTIAL INGREDIENTS, NUTRACEUTICAL, AND TRACE ELEMENTS IN HERBAL INFUSION

C. S. SANWAL¹, *A.K. BHANDARI¹, RAKESH BISHT¹, NARAYAN SINGH², M. BAUNTHIYAL³

¹Herbal Research and Development Institute, Mandal Gopeshwar, Chamoli (246401), Uttarakhand, India

²The Energy and Resources Institute (TERI), Latey Bunga, Mukteshwar, Nainital - 263 132, Uttarakhand

³G.B. Pant Institute of Engineering and Technology Pauri-Garhwal (246194), Uttarakhand, India

ABSTRACT

Herbal tea is also known as herbal infusion essentially made up of leaves, flowers, fruit, seeds, and/ or roots of various plant materials which does not have caffeine content. Herbal teas are usually mixtures of multiple ingredients, having prominent dietary sources of polyphenols which have a variety of health benefits. Several kinds of herbal teas have been used for their medicinal properties and some of them are being consumed for their energizing properties to help induce relaxation, curb stomach or digestive problems and also strengthen the immune system due to the presence of antioxidants. The study aimed to perform nutritional, phytochemical, and sensory analysis and assess the potential of herbal formulation made up of various herbs in possessing phytochemical contents and to be a part of herbal tea development. We developed six types of herbal teas, which are pre-dominantly contain proteins (12.49-22.05%), Energy (320-342 Kcal/100gm.), Tannins (2.22-5.67%), Vitamin C (0.20-0.85 mg/100gm.), Crude fiber (13.75-15.50%), Iron (0.10-0.85 mg/100gm), Copper (9.01-17.33) and Zink (16.94-42.45 mg/Kg). As part of nutritional analysis, tests such as moisture content, ash content, and mineral composition of the herbal formulation mixture were also performed. Formulation of all six herbal teas sensory analysis was performed to validate the aroma, color, astringency, flavor, and overall acceptability parameters in herbal tea. The results of the nutritional and phytochemical showed that the formulation mixture of herbs is an excellent source of Nutraceutical and vitamins with high therapeutical importance. Herbal Teas are commonly consumed for their therapeutic and energizing properties since they can help to induce relaxation. Intend of this study was to develop the formula for different herbal teas and to encourage farmers to take up the cultivation of herbs so that they can enhance their livelihood and society can benefit from it.

Key words: *Herbal tea, Phytochemicals, Nutraceutical, Vitamin*

EVALUATION OF THE ROLE OF MICRO AND MACRO ENVIRONMENTAL FEATURES ON THE ADAPTABILITY OF SAFFLOWER IN A GENOMIC CROP IMPROVEMENT PROGRAM

MEGHA SHARMA^{1*}, ARUN JAGANNATH¹, SHAIENDRA GOEL¹, ANI A. ELIAS²

¹Department of Botany, University of Delhi, Delhi, India-110007

²Institute of forest genetics and tree breeding, Coimbatore, Tamil Nadu, India

Purpose

Safflower (*Carthamus tinctorius* L.) that belongs to the family Asteraceae, is a nutritionally desirable oilseed crop with higher levels of unsaturated fatty acid(s). Besides oil, safflower is used as a colouring dye, a food flavouring agent, and as a source of plant-derived pharmaceuticals. Although being grown in more than twenty countries, safflower occupies the status of a minor oilseed crop, mainly due to lack of acceptance by farmers owing to its lower yield and oil content. A continuous breeding effort supported by identification of important genetic and genomic resources can speed up the development of high-yielding cultivars of safflower. Over the years, various genetic markers viz. SSR, AFLP, and SNP have been exploited for marker-assisted selection (MAS). However, application of MAS is inadequate for quantitative traits such as yield and seed oil. Thus, genomic selection (GS) that uses genome-wide markers is a promising method for the safflower crop improvement program. The environment plays a significant role in the heritability of these traits. Additionally, being a semi-arid crop, safflower shows adaptability to different environments which leads to its genetic variability (Ojaq et al,2020). Incorporating environmental variability in GS model can increase its predictive ability leading to more accurate selection. Safflower is cultivated in relatively marginal areas and identifying the most favourable environment of a cultivar can facilitate increase in production.

Methods

We collected a total of 288 soil samples from 60 cm deep pits from the major safflower cultivating states in India - Karnataka and Maharashtra as well as from our production field station in Delhi. We have been analysing these samples for physical and chemical features.

Result

An environmental relationship matrix will be developed based on the soil features. The matrix can be used to improve the prediction accuracy of the base GS model.

Conclusions

One of the greatest challenges in the precision agriculture is to collect reliable soil data that could delineate the variability in the soil properties (Lund 2008). With the high-resolution data we have, we expect to develop an index for cultivar adaptability to environmental features in marginal farmers' fields through this genomic safflower improvement program.

IPR AND UTILIZATION OF PLANT RESOURCES

NUSRAT UL ISLAM¹, SUMMIRA RAFIQ², GOWHAR ALI³, Z. A. DAR³, M. A. RATHER¹, ALTAF WANI¹, P. A. SOFI¹

1. Division of Genetics and Plant Breeding, FoA, Wadura, Sopore, SKUAST-Kashmir

2. Division of Entomology, FoA, Wadura, Sopore, SKUAST-Kashmir

3. AICRP on Maize-Srinagar Centre, SKUAST-Kashmir

ABSTRACT

Enforcement of Trade Related Aspects of Intellectual Property Rights Agreement (TRIPS) under World Trade Organization (WTO) has resulted in worldwide shift from free exchange and unhindered exploitation to controlled access to plant genetic resources (PGR). Intellectual property rights of plant breeders and farmers need to be protected either by adoption of a patent system or by some form of effective *sui generis* system or by any combination thereof. Use of plant genetic resources (PGR) refers to the process of researching their beneficial properties and using them to increase scientific knowledge and understanding or to develop commercial products. . PGRs are exchanged and searched continuously for specific traits to improve yields and nutritional value in crops. There is continuous search for newer resources to meet the future demands that arise with the emergence of new diseases, abiotic stresses, climate change, and enhanced demand for food and nutritional security. There is need to create avenues through which these can be easily accessed and enact effective policies for their protection especially in their hotspot and regions of high endemism. The rapid advancements in the fields of molecular biology, biotechnology and bioinformatics, led to the emergence of new legal, political and technological regimes regulating access to PGR. Three international negotiations impacted the access to PGR, these are the Convention on Biological Diversity (CBD), the Agreement on Trade-Related Aspects of Intellectual Property Rights (TRIPS) as part of the Agreement establishing the World Trade Organization (WTO) and the International Treaty on Plant Genetic Resources for Food and Agriculture (ITPGRFA). The Convention of Biological Diversity (CBD) 1993 recognised the sovereignty of nations over biological resources. The Biological Diversity Act, 2002 prohibits access to biological resources without the approval of designated authority. The regulation regarding access to PGRs, increasing application of IPRs and the vast potential of biological wealth yet to be tapped through bio-prospecting and genetic engineering, has placed greater demands on nations to adjust to the changing scenario of PGR management.

Key Words: Intellectual property rights, Plant genetic resources, CBD, TRIPS and WT

HIGH-THROUGHPUT PHENOTYPING FOR DEVELOPING CLIMATE CHANGE RESILIENT CROPS

NUSRAT UL ISLAM¹, SUMMIRA RAFIQ², GOWHAR ALI³, Z. A. DAR³, M. A. RATHER¹, ALTAF WANI¹, P. A. SOFI¹

1. Division of Genetics and Plant Breeding, FoA, Wadura, Sopore, SKUAST-Kashmir

2. Division of Entomology, FoA, Wadura, Sopore, SKUAST-Kashmir

3. AICRP on Maize-Srinagar Centre, SKUAST-Kashmir

ABSTRACT

Around 70 percent of crop yield losses are projected because of climate change induced abiotic stresses like moisture stress, soil salinity and heat stress. The current rate of crop improvement is predicted to be insufficient to meet the future needs of a growing human population, especially with an increasingly unstable climate in important cropping regions. Critical to the stability of cropping systems in the face of climate change is the capacity to rapidly grow germplasm with tolerance to complex polygenic inherited abiotic and biotic stresses combined. The slow development of new crop cultivars reflects, in part, the long generation times of crop plants. Molecular breeding provides the means to speed up cereal breeding, but adequate phenotyping protocols are required to ensure that the much-anticipated benefits of novel breeding tools can be realized. Tremendous advances in phenomics have taken place in the recent past. Both forward and reverse phenomics have developed to help determine either the best genotype with the desired feature or mechanism and the genes that make the genotype the best. High-throughput phenomics studies include techniques for screening substantial germplasm sets for a specific trait using high-throughput phenotyping (HTP) technologies like advanced robots, high-tech sensors, 3D imaging, fluorescence imaging, NIR imaging, Lemnatec, etc. The high velocity of plant phenotyping based on phenomics accelerates the selection phase of potential advanced germplasm resilient towards climate induced stresses. High-throughput phenotyping for abiotic stress coupled with the advanced genotyping technologies and other phenomic technologies like transcriptomics and metabolomics have accelerated the process of developing climate change resilient crops and thus cater the needs of global food challenge with respect to the changing climatic conditions and increasing population.

Key words: Climate change, Abiotic stresses High-throughput phenotyping, Forward and reverse phenomics, Climate change resilient crops

PRECISION AGRICULTURE: A NOVEL CROP MANAGEMENT STRATEGY

NUSRAT UL ISLAM¹, SUMMIRA RAFIQ², GOWHAR ALI³, Z. A. DAR³, M. A. RATHER¹, ALTAF WANI¹, P. A. SOFI¹

1. Division of Genetics and Plant Breeding, FoA, Wadura, Sopore, SKUAST-Kashmir

2. Division of Entomology, FoA, Wadura, Sopore, SKUAST-Kashmir

3. AICRP on Maize-Srinagar Centre, SKUAST-Kashmir

ABSTRACT

The rapidly-growing human population has increased food demands for human survival on the earth. Meeting the food requirements with limited resources of the planet is a big challenge. Several state-of-the-art technologies are being incorporated in the agriculture domain to enhance the productivity to cope with this challenge. Precision agriculture (PA), comprised of near and remote sensing techniques, is a modern practice used to enhance crops' productivity using latest technologies, i.e., wireless sensor network (WSN), internet of things (IoT), cloud

computing, artificial intelligence (AI) and machine learning (ML) which help to monitor crop states at multiple growth levels. PA involves the acquisition and processing of a large amount of data related to crop health. The objective of PA is to provide decision support systems based on multiple parameters of crops, i.e., soil nutrients, water level of the soil, wind speed, intensity of sunlight, temperature, humidity, chlorophyll content, etc. PA enables a farmer to know precisely what parameters are needed for healthy crop, where these parameters are needed and in what amount at a particular instance of time. PA includes retrieving real data about the conditions of soil, crops and weather from the sensors deployed in the fields. High-resolution images of crops are obtained from satellite or air-borne platforms (manned or unmanned), which are further processed to extract information used to provide future decisions. PA-based practices have a great influence on sustainability and productivity. The main objective of precision agriculture is to produce surplus yield by optimizing the resources such as water, pesticides, fertilizers, etc., for resource optimization, prescription maps play an important role, which enables farmers to quantify resources required for healthy crops at any particular growth stage. Most of the research accomplished in the agriculture domain focuses on the remote sensing platforms to collect imagery, which reflects only Vegetation Indices (VIs) such as NDVI. Precision agriculture provides a means to monitor the food production chain and manage both the quantity and quality of agricultural produce. Precision agriculture, as a crop management concept, can meet much of the increasing environmental, economic, market and public pressures on arable agriculture.

Keywords: Precision agriculture, Remote sensing techniques, Wireless sensor network, Artificial intelligence and Machine learning

PERFORMANCE OF FIELD PEA (*Pisum sativum*) AS *UTERA* CROP IN RELATION TO GROWTH DURATION OF RICE (*Oryza sativa*) UNDER RAINFED CONDITION

R.K. DWIVEDI*, M.K. AHIRWAR* AND R. JHARIYA*, R. KHAVSE*, A. BADGAIYA* AND AVDHESH PATEL**

***JNKVV. Krishi Vigyan Kendra Damoh (M.P.) Pin 470661**

ABSTRACT

The experiments were conducted during 2019-20 and 2020-21 on the farmers field at 10 locations covering 2 farmers in each of the 5 villages of Dindori district of Madhya Pradesh. The performance of field pea as an *utera* crop with early maturing rice variety Poornima and JR 36 was the best *utera* cropping with traditionally growth rice variety proved to be less remunerative (Rs. 22665/ha) because of very low yield of rice (17.5 q/ha) as well as *utera* crop (8.05 q/ha). The success of rice based *utera* cropping system appears to be much assured under rainfed situation by growing suitable *utera* crop with early medium rice variety due to efficient use of soil moisture.

Key words: field pea, rice-based cropping system, traditionally, *utera*.

IMPACT OF CLIMATE CHANGE ON INSECT PESTS, DISEASES AND THEIR MANAGEMENT

SUMMIRA RAFIQ¹, SHAFIYA RASHID², M. A. MANTOO¹, T. H. ASKARY¹,
NUSRAT UL ISLAM³

¹Division of Entomology, Sher-e-Kashmir University of Agricultural Sciences and Technology of Kashmir

²Division of Entomology, Sher-e-Kashmir University of Agricultural sciences and Technology of Jammu

³Division of Genetics and Plant Breeding, Sher-e-Kashmir University of Agricultural Sciences and Technology of Kashmir

ABSTRACT

Climate change along with rapidly increasing population and degradation of natural habitats and resources would have a direct influence on livelihoods, raising concerns for food security, water availability, health and energy. Climate change is an emerging global concern that has serious threats in every aspect of agriculture. Changing patterns in climatic factors like temperature, precipitation, humidity and other meteorological components are affecting the quality and quantity of agricultural commodities production. Along with direct impacts on crop productivity, climate change is one of the factors driving the spread of pests and diseases, along with the increasing global trade. Climatic change can affect the population size, survival rate and geographical distribution of pests and the intensity, development and geographical distribution of diseases and threatening global food production-related losses of food crops. Being poikilothermic, insects are the organisms that are most likely to respond to changes in climate and it is anticipated that the damage to crops by pests and diseases will increase as a consequence of climate change. Insects respond to climate change in different ways i.e., changes in an insect population's physiology, biochemistry, biogeography and population dynamics. Due to climate change, there is a rise in the number of insect pest populations, outbreaks of insects, increased number of generations and development of resistant biotypes. The impact of climatic change on crop production mediated through changes in the population of serious insect pests need to be given careful attention for planning and devising adaptation and mitigation strategies for future pest management programmes. Therefore, there is a need to have a concerted look at the likely effects of climatic change on crop protection and devise appropriate measures to mitigate the effects of climatic change on food security.

Keywords: Climate change, Agriculture, Insect pests, Plant diseases, Food security, Management.

HORTICULTURE- A PARADIGM SHIFT IN FOOD PRODUCTION AND SECURITY

R H DAHIYA

Horticulture and agribusiness management

Vice President Horticulture, Amol Pharmaceuticasl Pvt Ltd Jaipur, Rajasthan, India

ABSTRACT

In the changing global environment, food, nutrition, health care and livelihood security are the matter of great concern to socio economic development of human being. There has been appreciable progress in food production sector including horticulture crops. However, access to good nutritious food continues to be a cause of concern as millions of people continue to suffer from malnutrition that is a cause for various types of diseases and death of children and women. Therefore, countries will only be food secured if the people have access to nutritious food and balance diet to meet their need for productive and effective life. To overcome this gap horticultural crops namely, fruits, vegetables, tuber crops, mushroom, plantation crops, spices etc. have played a vital role not only to provide required nutrients but also to enhance access to food through enhanced farm profitability. Recent trends indicate that dietary habit is changing with increasing income, from cereal-based diet to nutritious diet which has resulted in a growing demand for horticultural produce. The proven facts and results shows that no doubt the horticulture sector is best option for diversification of food, nutrition, health care and livelihood security.

Horticulture can lead to be the best option?

Horticulture sector has wide adaptability that can provide numerous choices to the farmers for growing range of crops under different environment, soil and climatic conditions. Since horticulture crops can even be grown in marginal and degraded soils. There are many horticultural crops which are important part of food circle i.e. potato, tuber crops and banana, underutilized local fruits and vegetables. Medicinal plants, herbs, spices and vegetable therapy are these days a practice to have good health without medication as many of these crops are considered as high value crops due to their health and nutritional benefits. New paradigm in environment sustainability, climate change and food security and enhanced farm profitability has to be horticulture-based farming system.

Role of Horticulture for health care in recent years

Modern medicine at large takes care of the health of people but still in many parts of Asia about 70-80% of population believes in using herbs as medicine. Even in the modern medicine the doctors generally advice the use of balanced diet and consumption of fruits and vegetables that protects against many illnesses and enhances mechanism of immune system. In just a while back seeing the scenario of recent pandemic, Covid and its related complications for more than two years now horticultural crops such as fruits, vegetables and medicinal plants and herbs have gained their precious presence on every table and have become part and parcel of dietary habits all around the world. Medicinal herbs are once again being used and consumed in different ways by the population rich and poor due to their ample beneficial effect on health and fight against the wide spread disease.

The fruits such as aonla, bael, jamun, papaya, phalsa, etc., vegetables such as carrot, cauliflower, onion, garlic, beans, cucurbits, leafy vegetables, etc., spices such as ginger, turmeric, black pepper, fenugreek etc., and medicinal plants such as Arjuna, Tulsi, Giloe , Ashwaghandha, Hibiscus, Amaltash etc., protects against various kind of diseases. The spices like ginger, turmeric, chillies, pepper and cumin in the diet have been recognized to protect against many illnesses. Coconut the wonder, humble fruit is found to be a great source of mineral and nutrition. Horticultural crops thus provide ample opportunities for health care as

the nutrient needs are required by people irrespective of the gender, age, height, weight, physical condition, activity level and the climatic conditions where they live

Although Cereals are the main staple food which lack in various mineral and vitamins but to lead a healthy life, the food we eat should contain a wide range of nutrients in proper proportion i.e. for a well-balanced diet. The nutrients which are required include proteins, fat, carbohydrates, vitamins, fiber and minerals. There is no single fruit or vegetable which can nourish the body with all the vital ingredients it requires. It is important to consume a variety of fruits, vegetables, spices and herbs to derive required nutrition. Horticultural crops are therefore able to meet essential requirement for nourishment of our body these crops are rich source of energy, proteins, vitamins, minerals and antioxidants etc.

Thus, cultivation of horticultural crops plays a vital role in the prosperity of a nation and is directly linked with the health and happiness of the people. A large variety of fruits are grown in India, of which mango, banana, citrus, guava, grape, pineapple and apple are the major ones. Apart from these, fruits like papaya, sapota, annona, phalsa, jackfruit, ber, pomegranate in tropical and sub-tropical groups and peach, pear, almond, walnut, apricot and strawberry in the temperate group are grown in a sizeable area. Fruit and vegetables are indispensable as sources of vitamins and minerals, which help in building resistance against diseases. Fruits and vegetables furnish 90% of the vitamin C and 60% vitamin A in the world. Mango and papaya are rich in pro-vitamin A and guava in vitamin C, Banana, among fruits is a good source of carbohydrate. Fruits are also a rich source of organic acids like citric acid in citrus fruits and tartaric acid in grapes, which stimulate appetite and helps in digestion, Papaya contains protein digesting enzymes.

It has been observed that due to poverty level micronutrient malnutrition, is posing a threat to vulnerable sections in Asian countries in the form of vitamin A deficiency, iron deficiency, anemia and iodine deficiency disorders which could be minimized through horticulture intervention and awareness drive.

Apart from micronutrient related function, the bioactive phytochemicals present in fruits and vegetables prevent degenerative processes by antioxidant activity. In order to have protective effect, it is necessary to consume approximately 400-600g of fruits and vegetables every day yet the consumption level of fruits is low and widely variable from region to region in India. India is the second largest producer of fruits and vegetables in the world next only to Brazil and China with approximately 77 MT of fruits and 140 MT of vegetables. However, per capita consumption of fruits and vegetables is only around 46kg and 130g

Challenges Ahead:

The growing population is the major concern and is the big challenge for meeting the food needs worldwide. In the prevailing circumstances of globalization and urbanization, small farm land holdings, depleting water resources and changing climate, the situation has become more complex. Through the inputs of science and technology, challenges ahead could be converted into opportunities for sustainable production. Horticulture has proved to be the best mean of diversification for higher land productivity but there is a need to make the sustainable development in production of fruits, vegetables, tuber crops, medicinal crops and plantation crops for meeting the growing demand of rising population.

Climate change scenario and impact

Climate change has been and is a threat and will have impact on horticultural crops, due to erratic rainfall, more demand for water and enhanced biotic and abiotic stresses. However, the changes may only be harmful, as enhanced CO₂ concentration can enhance process of photosynthesis and increased temperature may hasten the process of maturity. At the same time increased temperature will have more effect on reproductive biology, reduction in fruit set and water stress may affect the productivity. Although adaptive mechanisms such as time

adjustment in cultivation and productive use of water shall reduce these negative impact on crops.

These challenges could be addressed and problems resolved through identification of the genes tolerant to high temperature, development of nutrient efficient cultivars and good agricultural practices in better production system for efficient use of nutrients and water. These strategies have to address the enhanced water efficiency and follow the practices that conserve water and promote crop productivity.

Development of horticultural crops which are tolerant to high temperature, moisture stress, salinity and climate proofing through biotechnology and genetics would be essentially required. There is and will be a need for highly prioritized research to address the impact of climate change as we are already facing the difficulties of harsh climate. We shall also be able to enhance the practical based knowledge to address all the strategies which can convert these challenges into opportunities. Integrated efforts and approaches with effectiveness will be essential to meet the ever-increasing demand in food production and consumption.

Way ahead towards ensuring nutritional and livelihood security

There is a need to enhance the level of food security and nutrition by improving the efficiency of the horticultural crop production system and support services such as marketing, processing and value addition, post-harvest loss prevention, etc. through the application of modern and Hi-Tech technologies and diversified cropping patterns, that will not only promote the production and productivity but also provide higher incomes to the small and marginal farmers in a profitable and sustainable manner.

The nutritional status of the population can be improved through creating an environment in which households has sufficient access to fruits and vegetables at affordable prices throughout the year and the necessary knowledge and skills to prepare and consume foods to complement their diet, specifically targeting the women and children.

Develop capability among low-income communities in increasing productivity year-round for production of horticultural crops: fruits, vegetables, spices and medicinal herbs through the introduction of superior quality planting materials and seeds alongside the promotion of production skills.

Minimizing post-harvest losses, improve postharvest handling and increasing growers' profits and income through the promotion of on-farm and community-based produce handling methods as well as to enhance marketing support services.

Promote income-generating activities, including agro-processing, food processing industry to enable the optimum utilization of horticultural produce to supplement family income.

Increase the nutritional awareness among the beneficiaries and develop a comprehensive food-based nutrition program to reduce malnutrition in the target groups comprising all groups of population with major focus on women and children.

Large scale production of fruits, vegetables, flowers, spices, medicinal plants and plantation crops has been successful in the past decade, and to continue to build on success, horticulture sector has to face challenges.

Therefore, there is an urgent need to prioritize the action plan outlining the research, development and extension, to make horticulture sector a key driver in economic development. Demand for high value and good quality safe produce is growing both in domestic and international market at the same time competition is also on the rise. New changes with the entry of corporate retail, strategically designed alliances and supply chain management, strengthening of research on impact assessment of climate change on horticultural crops using controlled environmental facilities and simulation models, analysis of weather data and integration with productivity changes including extreme events are walking hand in hand.

Production, demand and supply of fresh, safe commodities, economics and trade, sensitive stages and process during crop development, diversity and dynamics of major insects, microbes

and pathogens, intensification of studies on pest, disease and weather demands focused alteration and changes.

Therefore, sustainability will depend upon improving competitiveness, reducing impact on environment, quality assurance, food safety and capability of communities engaged in this sector to manage these changes.

NANOBIOTECHNOLOGY APPLICATIONS IN FOOD SECTOR AND FUTURE INNOVATIONS

NIVAS MANOHAR DESAI

Sadguru Gadage Maharaj College, Karad, Maharashtra, India

ABSTRACT

Food nanotechnology is an emerging and rapidly evolving field that encompasses an extremely broad range of disciplines and has found various applications in different food sectors. Bioactive compounds possess plenty of health benefits, but they are chemically unstable and susceptible to oxidative degradation. The application of pure bioactive compounds is also very limited in food and drug formulations due to their fast release, low solubility, and poor bioavailability. Encapsulation can preserve the bioactive compounds from environmental stresses, improve physicochemical functionalities, and enhance their health-promoting and anti-disease activities. Micro and nano-encapsulation based techniques and systems have great importance in food and pharmaceutical industries. The emerging applications evolve towards the preparation of nanoparticles with better physicochemical and biological properties. Nanoparticles of biopolymers like proteins (whey casein, gelatin, collagen, Keratin, etc.) and polysaccharides (starch, β glucan, cellulose, pectin, chitosan, pullulan, and others) allow the formation of fibers and capsules with good loading efficiency and delivery capacity of bioactive compounds. Bioactive compounds in the free form are often unstable and degradation during passage through the digestive system further decreases the amount of biologically active compounds reaching the absorption site. Encapsulation in a biopolymer matrix facilitates the delivery process and protects bioactive compounds like vitamins, polyphenols, and probiotics from harsh environmental, thermal, and gastrointestinal processes. Currently, the nanoencapsulation of bioactive compounds is highly popular and considered more advantageous than microencapsulation. The nanoencapsulation increases the bioavailability, solubility, and bioactivity of encapsulated compounds and thereby increases their bioavailability and bioactivity after digestion.

❖ Improve food consistency and prevent lump formation.

Improve nutritional value and texture of food products.

❖ Improve physical performance of food.

❖ Fortification of minerals and vitamins in foods.

❖ Enhance product shelf life.

❖ Reduce fat and sugar content.

❖ Provide controlled release at target site.

❖ Increase gas permeability, water resistance, and flame resistance.

❖ Nano-biosensors can detect foodborne pathogens.

❖ Able to bind and remove food contaminants.

❖ Help in innovative, lighter, stronger, and active packaging.

There are several benefits of nanoencapsulation system such as enhanced stability and integrity, change in flavor, enhanced bioavailability, easy handling of food products, pH- and moisture-triggered controlled release, long-lasting organoleptic perception, retention of volatile ingredients, taste making, protection against rancidity and oxidation, and consecutive delivery of multiple active ingredients. Nanoencapsulation with calcium alginate is observed to improve the viability of probiotic microorganisms such as *Bifidobacterium* sp., *Lactobacillus* casei, *Lb. acidophilus*, and *Lb. rhamnosus* in freeze-dried yogurt. Encapsulation of curcumin into hydrophobically modified starch showed improvement in its anticancerous property. Carotenoid nanoparticles showed improved bioavailability of carotenoids and nano-based mineral supplements (nano-iron and nano-calcium). Nanometer-sized micellar systems are also available for delivery of minerals, phytochemicals, and vitamins.

Food shortage is one of the major challenges which is expected to be faced by the world in the near future due to expanding population growth, pressure on environment, and efficiency on production system. The major challenge of food sector is development of better food manufacturing, preservation, and storage techniques to provide healthier and nutritious food for human welfare. Hence, nanobiotechnology is an alternate opportunity to overcome global problem and help in providing authenticated, nutritious, safe, secure, shelf-stable, high-quality, fortified, and therapeutic food products to future generations. It is widely accepted that nanofoods will be available largely to consumers worldwide in coming years.

Keywords: Nano-encapsulation, Bioactive Compounds, Biopolymers, Food Nanotechnology
Graphical Abstract

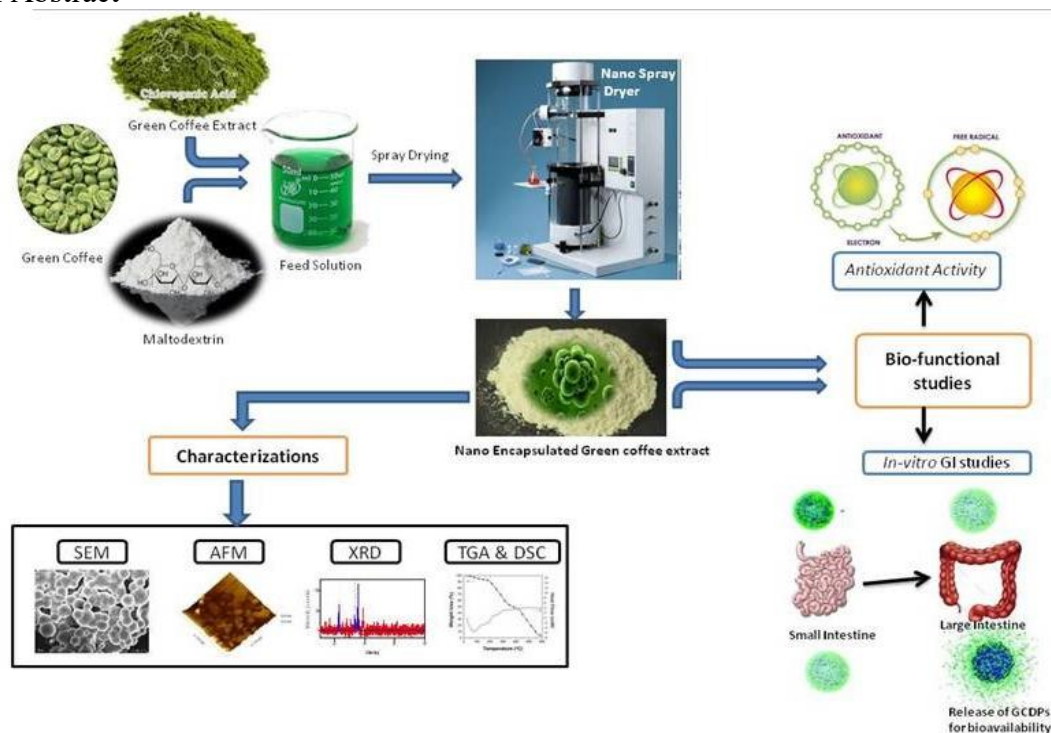

TEMPERATURE SUITABILITY AND CO-OCCURANCE UNDER CLIMATE CHANGE FOR THE FALL ARMYWORM, *Spodoptera frugiperda* (Lepidoptera: Noctuidae).

SHAFIYA RASHID^{1*}, R. K. GUPTA¹, SUMMIRA RAFIQ²

¹Sher-e-Kashmir University of Agricultural Sciences and Technology, Chatha, Jammu, 180009, India

²Sher-e-Kashmir University of Agricultural Sciences and Technology of Kashmir, Jammu & Kashmir, INDIA-193201

ABSTRACT

The fall armyworm, *Spodoptera frugiperda*, a highly invasive species native to North America has been rapidly spreading to other parts of the world. The species has rapidly spread to more than 26 countries in Africa and has been recently discovered in India, demonstrating its high potential to spread and invade. Temperature between 26 and 30 °C is the optimal range for egg, larval and egg-to-adult development. The optimum temperature with the fastest larval development rate and lowest mortality is at 30 °C. The minimum temperature threshold for egg development is 13.01 °C, and that for larvae and pupae is 12.12 and 13.06 °C, respectively. Thus *S. frugiperda* populations will not develop and persist in geographical regions where temperatures decrease to below these levels during winter months. However, with the expected climate change scenarios, it is possible that *S. frugiperda* will invade other areas, thus increasing the damage to major agricultural crops. Simulations indicate an enormous climatic potential for the spread of the species, with potential increases between 12 and 44% in the future. This will increase the potential for interactions between the fall armyworm and its main host plants. The potential co-occurrence with host plants highlights the areas that should be potentially targeted for monitoring.

Keywords: *Spodoptera frugiperda*, invasion, optimum temperature, climate change, potential damage.

ENHANCEMENT OF PLANT PRODUCTIVITY BY INTEGRATED NUTRIENT MANAGEMENT In *Melia composita*: AN OVERVIEW

QURAT UL AIN BINTE SYED^{1*}, K.K. SOOD¹

¹ Department of Agroforestry, Sher-e-Kashmir University of Agricultural Sciences & Technology of Jammu, 180009.

ABSTRACT

Nowadays the global economic productivity demands of a growing human population and need for an eco-friendly strategy for sustainable soil-plant-microbes-environmental system, require significant attention when addressing the issue of enhancing agricultural productivity. One possible way to enhance economic productivity by chemical fertilization, but due to injudicious uses of chemical input in agricultural system detonated the soil, food, environmental and human health, chemical fertilization also increasing their prices 21st century. However, it is not possible to supply all the nutrient requirements of crops through organic manures. *Melia dubia* has been screened as one of the best alternate of pulpwood species (Parthiban *et al.*, 2009). It belongs to the family Meliaceae, commercially known as Malabar Neem and is locally called as Malabar Vepa. It is a large deciduous and fast-growing tree with wide spreading branches, straight and tall bole. *Melia dubia* with its multi-various uses like pulpwood, timber, fuel wood and plywood can fit as a suitable species for agro and farm forestry plantation programme (Saravanan *et al.*, 2013). With the present scenario of environment pollution which

is detrimental to the sustainability there is an urgent need for adoption of farming practice which ensures soil health, human health, animal health and environmental health. Keeping this background in mind, influence of integrated nutrient management (INM) has been developed on the principles of eco-friendly and efficient balanced fertilization and based on optimization of nutrient supplies from all the available sources, inorganic and organic, for pre-defined yield targets of the crop through an efficient combination of soil, water, organic matter etc. INM is a system that helps to restore and sustain crop productivity and also assist in checking the emerging micro-nutrient deficiencies. Nutrient management has played a major role in accomplishing the enormous increase in food production. So by taking into consideration the above facts, integrated nutrient management (INM) has been developed. Integrated nutrient management INM is the best approach for better utilization of available resources and to produce crops with less expenditure. INM is also beneficial for marginal farmers who cannot afford to supply all crop nutrients through costly chemical fertilizations.

Key words: *Melia composita*, Agricultural System, Integrated Nutrient Management, Inorganic Fertilizers and Sustainable Crop Production

EFFICIENCY OF POST EMERGENCE HERBICIDE FOR ENHANCING YIELD ATTRIBUTES, YIELD AND ECONOMICS OF HYBRID MAIZE (*Zea mays* L.)

NOOR MOHAMMAD KAKAR¹, SAYED YUONUS AMINI², MOHIBULLAH SAMIM³

¹ANASTU, Kandahar, Afghanistan

²ICAR-IIMR, Pusa campus, New Delhi

³Division of Agronomy, IARI, Pusa campus, New Delhi

⁴IASRI, Pusa campus, New Delhi

ABSTRACT

An experiment was conducted at research farm of National Agricultural Science and Technology University (ANASTU), Kandahar, Afghanistan in randomized complete block (RCBD) during summer season of 2017 to evaluate the effect of post-emergence herbicides in maize. The experiment consisted ten treatments and replicated thrice. Among the weed control treatments, sequential application of atrazine @ 1.5 kg/ha pre-emergence followed by tembotrione 120 g/ha as PoE at 25 DAS recorded significantly higher grain row⁻¹ (36.18), number of grain cob⁻¹ (502.48) and Grain weight cob⁻¹ (137.63 g). Significantly higher grain and stover yield (6.7 and 11.6 t ha⁻¹) were recorded in weed free check plot which is on par with (T₁₀) atrazine @ 1.5 kg/ha pre emergence fb tembotrione 120 g /ha PoE at 25 DAS (6.5 and 11.4 t ha⁻¹) and (T₉) pendimethalin (1000 ml/ha) pre emergence fb atrazine (750 g/ha) + 2,4-D Amine 0.4 kg /ha at 25 DAS as PoE (6.2 and 11.0 t ha⁻¹). The benefit cost ratio was higher (1.57) in sequential application of Atrazine 1.5 kg/ha fb 2,4-D Amine 0.4 kg/ha at 25 DAS as PoE, which was on par with Pendimethalin (1000 ml/ha) pre emergence fb Atrazine (750 g/ha) + 2,4-D Amine 0.4 kg/ha at 25 DAS as PoE and (T₇) Atrazine @ 1.5 kg/ha pre emergence fb Halosulfuron 67 g/ha 25 DAS.

Keywords: B:C ratio, Economics, Harvest Index, Post-emergence herbicide, weed management, yield

WOMEN AND ENVIRONMENTAL GOVERNANCE IN HIMALAYAS: A CASE STUDY OF UPPER KULLU VALLEY

MONICA AHLAWAT

Department of Geography, Dr. B.R. Ambedkar College, University of Delhi, Delhi, INDIA

Purpose

The term environment is much used in current times. Its content is defined as variously or as broadly as its user determines. Environment denotes all these resources, which make up the totality of the productive base of a region, which is inhabited by people. These resources include land, forests, water, livestock and people. The real meaning is in the interaction between people who are the users of the environment. While all human beings interact with the environment, the people who are closest to it, both as users and as nurturers are women.

Methodology

The statistical base of the study has been provided by both primary and secondary type of information. Primary data have been collected through questionnaire survey conducted in 16 hamlets in area of study & a total of 115 respondents have been questioned. Secondary data was collected through Meteorological Department, Census of India, Wildlife Department etc. Discussions were also held with DRDO officers, Chief Conservator of Forest, Chairman of Mahila Mandal organizations and village School Teachers. The present work is based on the first-hand study and analysis of the role of the women in the utilization, development and management of the mountain environment in upper Kullu valley in Himachal Pradesh.

Results

Rural women are the main producers of the world's staple crops - rice, wheat, maize - which provide up to 90 per cent of the rural poor's food intake. Women sow, weed, apply fertilizer and pesticides, harvest and thresh the crops. Environmental governance refers to the rules, processes and behavior that affect the way power is exercised at all levels in the field of environmental policy. It also includes other areas that have an impact on the environment, and concepts such as openness participation, accountability, effectiveness and coherence. Women do not exist & are unreasonably positioned in environmental governance. They are less involved in environmental decision making & have less capacity in participating in environmental decision making. The disparity between men and women are hardly addressed in environmental decision making. The impacts of environmental decision making to women are barely assessed. Land is one of the most important resources in any region. Women play an important role in land resource management as they are directly related to agriculture, farming, fuel wood collection etc. Participation and contribution of females in agricultural activity continues throughout the year but it has some seasonal variations also. Women devote maximum time in crop farming during harvesting season and the sowing season. Usually it is observed that women devote time in removing weeds and other unnecessary plants and helps in maintaining the quality of the Land. The significance of women's presence in Environmental Governance is through Better way to gender equality, Enhancement of environmental protection, improvement of environmental legal system and good environmental governance. A well-known social organization, Mahila Mandal takes keen interest in management of forest resource of the area. Besides helping the forest department in finding illegal felling of trees in the forests and theft of fuel wood, the Mahila Mandal helps in forest regeneration programmes such as Afforestation. Women contribute significantly to animal husbandry activities.

Conclusion

Women play a significant role in sustainable development by utilizing all the local resources judiciously. In course of activities like collecting fodder and fuel wood they become familiar with the problems of forest. The impending shortage of fuel wood has made women aware

about the deforestation problems. Very few women in the study area has decision making power so despite being aware of the problems of deforestation they could not check it. So more power should be provided to women in decision making. Social organisations like Mahila Mandal should be promoted to counter the problems faced by women.

Key Words: Women, Mountain, Environment, Governance

STUDIES ON PEACH BUDDING IN STOOL BEDS OF 'RUBIRA' ROOTSTOCK

PREETIKA VERMA^{1*}, NAVEEN C SHARMA¹, PRAMOD VERMA AND UDAY SHARMA

Dr Yashwant Singh Parmar University of Horticulture & Forestry, Nauni, Solan, H.P., India

Purpose

Peach (*Prunus persica* L. Batsch) is commonly propagated by tongue grafting. 'Rubira' peach rootstock multiplied through mould layering becomes unsuitable for tongue grafting at the end of season due to excessive diameter of stool shoots forced to go for cleft grafting, which lead to reduction in graft take success. However, this rootstock can be budded in stool beds during summer or rainy season of the same year when the thickness of the rootstock is appropriate for budding to produce a budded plant within one year. The aim of the study was to standardize the ideal method and time of summer budding in peach in stool beds of 'Rubira' rootstock for higher bud take success and production of saleable budded plants within the same season.

Methods

The experiment was laid out during 2020-21 in a Randomized block design (Factorial) with three budding methods (chip, shield and patch beddings) performed at five different timings at 15-days interval between 22nd May and 21st July. There were total 15 treatment combinations which were replicated three times. The observation on bud take success, scion height, scion diameter, number of leaves per plant, fresh and dry weight of shoots, fresh and dry weight of roots, root-shoot biomass and saleable plants were recorded as per standard procedures during the course of investigation.

Results

A significantly higher bud take success (100%) was recorded in chip budding performed on 21st June followed by 6th June (96.67%) and 22nd May (93.33%). The patch budding performed on 21st June and 6th July and shield budding performed on 6th July also exhibited 100 per cent bud take success. The chip budding performed on 22nd May also exhibited highest scion height (149.17 cm), scion diameter (12.70 mm), number of leaves per plant (128.87), fresh and dry weight of shoots (150.33 and 86.67 g, respectively) and root-shoot biomass (106 g). However, maximum number of saleable budded plants (93.33%) was obtained in shield and patch budding performed on 6th June but it was closely followed by chip budding performed on 22nd May.

Conclusions

Chip budding performed during 22nd May and 6th June was proved to be the best methods and time for budding of peach on 'Rubira' rootstock in the stool beds to produce quality nursery plants within one year on the basis of bud take success of more than 90 per cent and significantly higher growth of budded plants.

Key words: Peach, Rubira, bud take and plant growth

INSECT BIODIVERSITY IN AN AGRICULTURAL ECOSYSTEM OF TARAI REGION OF RAMNAGAR, UTTARAKHAND

REKHA*, DEEPIKA GOSWAMI, DEEKSHA ARYA AND B. R. KAUSHAL
Department of Zoology, D.S.B. Campus, Kumaun University, Nainital-263001,
Uttarakhand, India

ABSTRACT

Species diversity and abundance of insects associated in an agricultural ecosystem was studied in Tarai region of district Nainital in Ramnagar, Uttarakhand. Biodiversity is essential for maintaining the ecological functions and provides diverse functional roles in the ecosystems. Insects play crucial role in establishing ecosystems by influencing the relationship between flora and fauna. Insect diversity is essential for valuable services such as scavenger and pollination. Ramnagar the gateway of oldest National Park “Corbett” is located at foothills of Himalayan region and due to its unique geographical location covered with mixed forests and crops, it allured high insect diversity. The survival of these ecosystems and wildlife sustained are now threatened by human activities like harvesting, agricultural expansion, anthropogenic activities, population explosion, urbanization, pollution, lax implementation of environmental policies and tourism, the insect biodiversity of Ramnagar is getting extinct day by day. Not only does this affect the food chain, but also the livelihood and the culture of millions of Indians who depend on local biodiversity. Conservation is an ethic of assets use, allocation and protection. Its primary focus is upon maintaining the health of the natural world, its habits and biodiversity. Biodiversity preservation in ecosystems can provide information about maintenance of environmental resources and sustainable development. The aim of study is to conclude insect diversity, abundance and species richness of agricultural ecosystem of Ramnagar.

Key Words: Agricultural ecosystem, Abundance, Biodiversity, Insects, Tarai region

APPLICATION OF REMOTE SENSING AND GEOGRAPHICAL INFORMATION SYSTEM IN AGRICULTURE AND NATURAL RESOURCES MANAGEMENT

SUMMIRA RAFIQ¹, NUSRAT UL ISLAM², SHAFIYA RASHID³, QURAT-UL-AIN BINTE SYED⁴, AMREENA AKHTER⁵

¹Division of Entomology, Sher-e-Kashmir University of Agricultural Sciences and Technology of Kashmir

²Division of Genetics and Plant Breeding, Sher-e-Kashmir University of Agricultural Sciences and Technology of Kashmir

³Division of Entomology, Sher-e-Kashmir University of Agricultural sciences and Technology of Jammu

⁴Division of Agroforestry, Sher-e-Kashmir University of Agricultural sciences and Technology of Jammu

Faculty of Forestry, Sher-e-Kashmir University of Agricultural Sciences and Technology of Kashmir

ABSTRACT

Agricultural production systems are highly vulnerable to variations in climate, soil and topography of different regions. For sustainable agricultural management, all these factors need to be analysed on a Spatio-temporal basis. Advanced techniques like remote sensing, global positioning system and geographical information system can be of great use for their

assessment and management. Remote sensing and Geographical Information System (GIS) offers an abundant opportunity to monitor and manage natural resources at multi-temporal, multi-spectral and multi-spatial resolution. It is an urgent need to understand the specialized capabilities of an ever-expanding array of image sources and analysis techniques for natural resource managers. Remote sensing and Geographical Information Systems are essential tools with a wide range of applications to tackle these issues. These technologies have manifold applications in agriculture including crop discrimination, crop growth monitoring/stress detection, crop inventory, soil moisture estimation, computation of crop evapotranspiration, site-specific management/precision agriculture, crop acreage estimation and yield prediction. Timely and reliable information on crop acreage, growth condition and yield estimation can be highly beneficial to the producers, managers and policy planners for taking tactical decisions regarding food security, import/export and economic impact. Such information on a regional basis can be made available with the use of remote sensing and geographical information system techniques. Remote sensing and GIS can also be used very effectively in land use/land cover analysis as well as damage assessment because of drought, floods and other extreme weather events due to changing climatic scenarios.

Keywords: Geographical information system, Remote sensing, Natural resources management, Crop yield prediction

ONE CARRIER SPACE-CHARGE-LIMITED CURRENT FLOW IN INSULATOR

R. JHARIYA, M.K. AHIRWAR, R.K. DWIVEDI AND R. KHAVSE
JNKVV. Krishi Vigyan Kendra Damoh (M.P.) Pin 470661

ABSTRACT

The formation of space-charge near cathode occurs during the gathering of the current carriers. The further injection of space-charge current density is restricted due to the mutual repulsion between the individual current carriers. The carrier injection is called single injection, if a single type of current carrier is injected from cathode and collected at the anode of the insulated diode. It is a necessary condition to maintain the carrier injection in the insulator. It gives space-charge limited current flow which is known as SCL current in insulator. It is observed experimentally that the sufficient numbers of electrons are injected from the metal to the insulator even at room temperature. The applied voltage is developed across the diode is represented by $eV(L)$, here e is the electronic charge and L is the device length. The space-charge reservoir of electrons occurs near the source which is known as cathode, it creates the curvature of conduction. The holes may also be injected in a similar manner into the valence band of the diode with the help of suitable metallic contact. It gives an important mechanism of conduction in insulators.

Key words: space-charge, insulator, current carriers, single injection.

BIOFORMULATION OF ENTOMOPATHOGENIC FUNGUS Against *Helopeltis theivora* WATERHOUSE (HEMIPTERA: MIRIDAE)”

PRIYA KAUR AND PURNIMA DAS

**Department Of Entomology Faculty of Agriculture Assam Agricultural University
Jorhat-785013 (Assam)**

ABSTRACT

Pathogenicity test of 5 strains or isolate of entomopathogens on adult *Helopeltis theivora* were carried out in the Physiology Laboratory, Department of Entomology, Assam Agricultural University, Jorhat during 2019-2021. Among the strains or isolate, *Archips sp.* isolate showed the best results at concentration 1×10^7 conidia/ml. The radial growth of *Archips sp.* isolate was found to be 75.33 mm. At concentration 1×10^7 conidia/ml, the conidial density, germination and pathogenicity of *Archips sp.* isolate was 8.08×10^7 conidia/ml, 85.49% and 80%, respectively.

Morphological characters of *Archips sp.* isolate were studied and its molecular characterization was carried out by using CP plant gDNA mini kit protocol and its accession no. was assigned as OM321438. While *Archips sp.* isolate when grown on liquid media supplemented with carbon, nitrogen and mineral sources (Glucose, Peptone and $MgCl_2$), the medium supplemented with the mineral source- $MgCl_2$ (0.75%) showed maximum conidial load (6.54×10^7 conidia/ml) and maximum germination (88.91%). Three talc-based formulations were prepared. One was prepared by using base material as harvested from PDB supplemented with 0.75% $MgCl_2$, second with combination of all the nutrients (0.75% Glucose, 0.75% Peptone and 0.75% $MgCl_2$) and third without nutrient. And among these formulations, all nutrients supplemented talc-based formulation showed maximum conidial density (11.52×10^7 conidia/ml) and germination (90.06%). Also, in order to increase the virulence and efficacy of the prepared bio-formulation, two stickers- Tween-80 and Triton-X@ 0.01% and two spreader oils-coconut oil and mustard oil@ 0.025% were tested. It was found that the formulation incorporated with Tween-80@ 0.01% and coconut oil @0.025% had maximum conidial load (13.12×10^7 conidia/ml) and spore germination (95.49%). Three doses viz., 5, 10, 15 gm/L were tested on the adults of *Helopeltis theivora*. Among these doses, the dose of 15 gm/L showed the highest mortality (88%) at 9th DOT.

SELECTION OF *Melia composita* Willd. PLUS TREES FOR GENETIC DIVERSITY ANALYSIS IN ARUNACHAL PRADESH, INDIA

UNSHANI DARYAL^{1*}, SHIVANI DOBHAL¹

¹college Of Horticulture And Forestry, Cau, Pasighat, India

ABSTRACT

Melia composita is a fast-growing deciduous tree species native to India. It is an important multipurpose tree species suitable for agro and farm forestry, hugely valued for pulp and plywood. The continuous increase of population has put tremendous pressure on the resources of forests for various end uses. Recently, the demand for this tree species has rapidly increased as a result of its potential as a timber species in different parts of India for large-scale plantations. Genetic diversity analysis is important to produce genetically improved planting stocked to meet the unending demands of the species for which the selection of plus trees is crucial.

In the present study, a survey was conducted in 11 villages of East Siang district, Arunachal Pradesh. It was observed that the tree species were found scattered in tribal home gardens.

Based on total tree height (h), clear bole height (cbh), girth at breast height (gbh), collar girth (cg), straightness (st.) and branching behavior (br.), an initial 65 candidate plus trees of *Melia composita* were selected. Using the selection index method, the selected trees were further screened to select potential *Melia* tree species for genetic diversity studies.

The total index value and the clear bole height showed maximum improvement percentage after selection. The mean values before selection for average h, cbh, gbh, cg, st., br. and index values were 1028.15, 307.38, 79.45, 93.33, 2.75, 2.69 and 44.32, which after selection were improved to 1141.18, 417.35, 93.54, 107.74, 3.59, 3.53 and 172.15, respectively. In terms of percent of improvement, substantial improvement for cbh and st. was recorded followed by br., gbh, cg and h. The recorded quantitative traits of the available trees were indexed and on a high index value basis and a total of 34 plus trees were selected.

The 34 phenotypically superior plus trees screened through the selection index method can be used for further analysis work.

Keywords: Genetic diversity, Plus trees, Selection index, Tribal home garden, *Melia composita*

SEX DETERMINATION METHODS IN FARM ANIMALS

SANJEEV RANJAN

Veterinary Science), Krishi Vigyan Kendra, Nalanda, Bihar Agricultural University, Sabour, Bhagalpur, India

INTRODUCTION

One of the uncertainties in reproduction of farm animals, regardless of whether one considers natural reproduction or reproduction assisted by artificial insemination or embryo transfer, is sex of the resulting offspring. This uncertainty can be of significant consequence when the economic value of one sex is considerably greater than that of the other. There are many unsubstantiated folk l-stories available in the literature which recommended that use of a particular method can alter the sex ratio of resulting progenies. Although the gonadal and phenotypic sex are determined later, the genetic sex of a mammal is set at fertilization and depends on whether the X-bearing haploid ovum is fertilized by X or Y bearing haploid spermatozoon.

Possible alternatives

Logically, separation of X-bearing and Y-bearing spermatozoa should undoubtedly be the ideal method of sex selection. Thus, sex could be predetermined if X and Y spermatozoa were separated before insemination. Although some progress in this field has been reported in conjunction with human artificial insemination, these procedures have not yet been successfully extended to agriculturally important animals. Despite the existence of producers that are commercially available for sexing of semen, researchers have generally concluded from results of controlled studies that no such technique can be used to control the sex ratio consistently.

An alternate approach to affecting the sex ratio is identification of the sex of pre implantation embryos after they have been flushed from the reproductive tract of a female and before they are subjected to embryo transfer.

Separation of Spermatozoa

The possibility of separating sperm bearing the X from those bearing the Y chromosome has since long attracted the scientific investigators, physicians and animal breeders. Numerous reports have been published which claimed that such a separation is possible based on physical methods. These include sedimentation rate, counter stream configuration or electrophoresis of the cells under a variety of conditions, and the use of systems that depend on differential

migration of spermatozoa in colloidal media. Claims of success in recent years, coupled with advances in biological knowledge and technology have resulted in three broad-based symposia to evaluate the present state and future prospects. At none of these meetings was there general acceptance of the success of any method, the recurrent theme in this area of investigation has been the mobility to reproduce results. The limiting factors in the separation of X and Y bearing mammalian sperms by physical means are the relative magnitudes of the variations between the two classes of cells and variation within each class. Research on techniques designed to separate sperm cells has also been hampered by the lack of laboratory tests to evaluate the degree of separation.

In 1969, prospective investigation of the effect of various treatments on the X/Y sperm ratio in the ejaculate of man became possible with the discovery of a method for Y body staining. However, it is now generally agreed that in domestic animals the Y chromosome does not fluoresce (Pearson *et al.*, 1971; Ericsson *et al.*, 1973).

Insemination of super ovulated females with supposedly enriched semen followed by embryo sexing might be other experimental approach. Pinkel *et al.* (1983) described a very useful method to evaluate claims of enrichment. They used technique for measuring the nuclear DNA content by flow cytometry that allows determination of the proportion of X and Y chromosome bearing spermatozoa. The process has been adopted for spermatozoa of domestic animals (Garner *et al.* 1983) and can be used to assess the effectiveness of method of sperm Separation much faster and cheaper than determining the sex ratio of embryos or live born animals. For example, samples of bovine semen processed for enrichment with a variety of techniques turned out to have equal proportions of X and Y sperm when analysed with flow cytometry (Pinkel *et al.* 1983). At the present time, sorting sperm cells by flow cytometry is destructive and even if a marker of the chromosome constitution of viable sperm is found, flow cytometry cannot provide a practical answer for commercial application. The number of sperm required for each insemination is in the millions and is beyond what flow sorting can supply. However, flow cytometry can be of great importance for facilitating development of new techniques for sexing spermatozoa.

(B) Sex Chromatin and / or Y Body Identification

The sex chromatin method depends upon the identification of a dark staining body, approximately 0.8x 1.1 μ m in size, lying adjacent to the nuclear membrane in fixed and stained interphase cells. The body known as a Barr body is seen in a proportion of female cells and represents the heterochromatic, inactive, X chromosome. In keeping with the fact that there is generally only one active X chromosome, individuals have as many Barr bodies as they have X chromosomes in excess of 1. In some species, this provides a rapid and useful approach to determining the genetic sex of embryos at transfer and foetuses and of foetuses later in gestation. However, this technique is not applicable to domestic species since the granular nature of cytoplasm makes it difficult to observe the Barr body. Furthermore, even in normal female human epithelial cells, the Barr body is observed in 50% of the cells and is dependent on the stage of the cell cycle and the orientation of the nucleus on the slide.

(C) Sex Chromosomal Analysis

This is a direct method of observing the presence of XX or XY chromosomes in the embryonic cells at metaphase. If sufficient cells are in mitosis, chromosome preparations can be made by a direct method; If not in mitosis the cells have to be cultured and harvested at the appropriate time. The embryonic cells can be collected and processed at different stages of embryonic development.

Betteridge *et al.* (1981) described a procedure whereby trophoblastic cells were removed from bovine embryos and processed for examination of sex chromosomes. These trophoblasts were collected between day 6-7 as well as day 12-15 through biopsy. They have also summarized results from 4 laboratories that used this procedure on day 12 to day 15 bovine embryos and

concluded that only approximately two thirds of the embryos could be sexed with certainty. Absence of metaphase spread and presence of only incomplete spreads after processing the biopsied cells were some resultant problems. Embryos at day-14 are approximately 1 week older than those commonly collected and transferred by non-surgical means. They cannot currently be stored for more than a few hours and, upon transfer to recipients, only approximately a third of the embryos result in pregnancy. Later, with the refinement of techniques of micro manipulation and splitting, half embryos were also processed for chromosome preparation. Despite the promise that this procedure showed and the enthusiasm it generated when first described, it has been largely abandoned for commercial use.

(D) Detection of H-Y antigen

A possible alternative method of sexing embryos is the serological demonstration of the H-Y antigen. The H-Y antigen was first detected in 1955 when it was observed that female mice rejected skin grafts from male syngenic mice (Eichwald and Silmsler, 1955), whereas skin grafts exchanged among the other sex combinations were accepted. This rejection was attributed to H-Y (Histocompatibility-Y) antigen, present in cells of the male but not in those of the female (Billingham and Silvers, 1960). Serum from females that have rejected male skin grafts contains antibodies. (H-Y antibodies) those are able to identify male cells in serological systems. The molecule conferring H-Y antigenicity is phylogenetically conservative. H-Y antibodies of the mouse and rat have been used to identify XY cells in more than seventy species from all classes of vertebrates. Among the mammals, H-Y is present in males of cattle, sheep, goat, horse, pig and human (Wachtel, 1983). Regarding its functional aspects H-Y antigen has been suspected of taking part in the process of primary sex determination (Wachtel, 1983).

(E) Hormonal Assays

The possibility also exists of diagnosing sex prenatally by assay of fetal fluids for hormones (Particularly those produced by the testis). This could be considered as an alternative to chromosomal analysis of cells from the same material collected by amniocentesis or laparoscopy. To be useful for sexing a hormone must (a) be measurable (b) exist in fluids or tissue obtainable from the conceptus and (c) differ between the sexes unambiguously. So far the only group of hormones to have met most of the above criteria are fetal testicular androgens. However, observations at several laboratories are not encouraging to explore this technique for future research.

(F) Y- Specific DNA probes

Use of DNA probes specific to Y-chromosome is new approach attempting to accurately determine the sex of preimplantation embryos. Here, a DNA sequence complementary to the target sequence of gene which is present only on the Y- chromosome is used as a probe. The probe can be either radiolabelled or non-radiolabelled, i.e., biotinylated (Boehm, 1986) or deoxygenated and have been used to detect the presence of Y chromosome in preparation of antenatal cells (Bohem, 1986) and in biopsy of blastocyst stage embryos (Leonard *et al.*, 1987) in human and animals. This technique involves isolation of DNA, gel electrophoresis hybridisation by blotting and autoradiography and takes about 30 hours. In bovines, 7 to 8 day old embryos are collected and 10 to 20 trophoblast cell are removed by biopsy and treated to allow in situ hybridization. It has an accuracy of 95 percent. However, the main disadvantage encountered here is that being an invasive method, it decreases the viability of embryos and limits other potential manipulations which are routinely being carried out with pre implantation embryos.

(G) PCR Techniques in Embryo Sexing

Recent developments in the field of molecular biology and recombinant DNA technology have made it possible to use PCR for the amplification of Y specific DNA sequence using special primers. Many workers have attempted to sex bovine embryos, by this technique (peura, 1991;

Agrawala, 1992; Machaty, 1993; Bredbacka, 1995 and Thibier, 1995). PCR is basically an enzymatic DNA amplification process which involves three steps of denaturation, primer, annealing and primer extension which are repeated many times so that there is an exponential increase in the DNA content. The whole procedure is involved in designing the primers by cloning Y specific DNA and genomic library construction. Different steps involved in this technique are as follows.

Biopsy of Embryos

Lysis of Blastomeres and Isolation of DNA

PCR Amplification of Y- Specific DNA

Identification of Sex of Embryos

References:

- Agrawala, P.L, Winger, V.A and Goldermann, H (1992). *Theriogenology*, 38: 969-978.
- Betteridge, K.J, Hare, W.C.D., and Singh, E.L. (1981). In *new technologies in animal breeding* pp. 109-125. Academic Press, New York, London.
- Bilingham, R.E and Silvers, W.K. (1960). *J. Immunol.* 85: 14-26.
- Bocham. T.L.J. and Drakovsky, D. (1986). *Clin. Genet.*, 30: 509-514.
- Bredbacka, P. Kankannapea, A. and Peippo, J. (1995). *Theriogenology*, 44: 167-176.
- Eichwald. E.J and Silmscrum C.R. (1995). *Transplant Bull.* 2: 148-149.
- Bricsson, R.J. Langevin, C.N and Nishino, M. (1973) *Nature*, 246: 421-424
- Garner, D.L, Gledhill, B. L, Pinkel, D., Lake, S., Stephenson, D., VanDilla, M.A and Johnson, L.A (1983). *Biol. Reprod.*, 28: 312-321.
- Leonard, M., Kirszenbaum, M., Continot., C., Chesne, P., Heyman, Y., Stinkre, M.G., Bishop, C., Delouis, C., Vaiman, M. And Fellous, M. (1987). *Theriogenology*, 27: 248.
- Machaty, Z., Paldi, A., Csakai, T., Varga, Z., Kiss, I., Barandi, I. And Vajata, G. (1993). *J. Reprod. Fertile.*, 98: 467-470.
- Pearson, P.L., Bobrow, M., Vosa, C.G and Barlow, P.W. (1971). *Nature*, 231: 326-329.
- Peura, T., Hyttinen, J.M., Turunen, M. and Janne, J. (1991). *Theriogenology*, 35: 547-535.
- Pinkel. D., Garner, D. L., Gledhill, B.L., Lake, S. Stephenson, D., VanDilla, M.A. and Johnson, L.A. (1983). *J. Anim. Sci.*, 57: 366.
- Thibier, M. and Nibart, M. (1995). *Theriogenology*, 43: 71-80.
- Wachtel, S.S (1983). *H-Y antigen and the biology of sex determination*. Grune and Stratton, NY.

MORPHOLOGICAL CHARACTERIZATION OF PALMAROSA (*Cymbopogon martinii*) FOR ESSENTIAL OIL CONCENTRATION

PAWAN KUMAR^{1*}, AJAY KUMAR¹, RAHUL DEV GAUTAM¹, RAVI KUMAR¹, SANATSUJAT SINGH¹, AND ASHOK KUMAR^{1*}

¹Agrotechnology Division, Council of Scientific and Industrial Research - Institute of Himalayan Bioresource Technology, Palampur - 176061 (Himachal Pradesh) India

ABSTRACT

Cymbopogon martinii (Roxb.) W. Watson, commonly known as palmarosa or rusa grass, is a perennial evergreen aromatic plant cultivated for its essential oil. The essential oil has high demand in cosmetics, tobacco products, and perfumery industries. Palmarosa belongs to the family Poaceae with a chromosome number of $2n = 20$ and is native to India. India exports ~147 tons of palmarosa essential oil to the USA and Europe. An open-pollinated population developed as breeding material at the CSIR-Institute of Himalayan Bioresource Technology (CSIR-IHBT), Palampur, was used in the study. A total of 64 lines selected from the breeding material were screened for morphological traits and biomass yield. The characters recorded are as follows.

a direct or indirect effect on the essential oil of the crop. A significant variation was recorded for the following traits: plant height, stem thickness, number of effective tillers, leaf length, flower head length, flower head diameter and above-ground biomass. Selected lines can be developed as varieties for cultivation and used in breeding programs to develop palmarosa varieties with higher essential oil yield and wider adaptability.

Keywords: Biomass; *Cymbopogon martini*; essential oil; Palmarosa

CONSEQUENCES OF COVID-19 ON THE ENVIRONMENT & SOCIETY

DROUPTI YADAV¹, ARTI YADAV²

¹Environmental Science, SLSBT, CSJM University Kanpur Nagar, U.P., India

² A.N.D. College, Kanpur Nagar, U.P., India

ABSTRACT

Climate change and global warming along with many other reasons like of increasing human population, industrialization, pollution, exploitation & depletion of natural resources (urban/rural), deforestation, and unplanned infrastructural development etc., play drastic role in this havoc. COVID-19 pandemic became bane for the Human population. Human population was effected due to sudden collapse of fast growing business, lack of tourism, economic crisis, life loss, offline markets in all streams except few services like medical, security and online services etc. Lots of studies shows that the COVID-19 impacted in both developing countries as well as the developed nations.

In the recent times environmental sustainability are major concern for the global academician, scientists and researchers. In spite of the adverse consequences on human beings, COVID-19 provided a better circumstance for accelerating the environmental balance. The change in regular lifestyle of the society greatly harsh the emission of carbon which directly impacted on the level of pollution. Many studies reported that it's affected positively for the environment due to less human interventions (due to lockdown situations) throughout the world. Environmental (air, water and soil) balance was positively impacted during lockdown. Due to the controlled automobile sector vehicular pollution was quite less. The atmosphere was looking clear due to less air pollution.

It's time to find out the lots of methods and measures which are required to maintain the ecological balance and find out the feasible solutions for many environmental problems like improve quality of waste water and minimize the hospital waste, such as masks, gloves etc. The impact of lockdown on small scale businesses, man, women, children, senior citizens (urban and rural areas) can be analysed to develop the effective plans for future disaster like pandemics. But this entire period science & technology play vital role for the human development. Now science and technology became boon for the environmental protection and sustainable development in various real time data availability which helps in decision making at economic, social, environmental, political, legal, and administrative level and ultimately protect from the losses due to pandemic.

Key Words: Covid-19, Consequences, Environment, Society, Sustainability.

COLLECTION AND PROFILING OF MAIZE GENETIC RESOURCES TO REDESIGN MAIZE AS A NUTRICEREAL

SURINDER SANDHU*, YOGESH VIKAL, GAGANDEEP SINGH, TOSH GARG, WAJHAT UN NISA AND HARJOT KAUR

Department of Plant Breeding and Genetics, Punjab Agricultural University, Ludhiana-141 004 (Punjab), India

ABSTRACT

With remarkable research interventions, India not only achieved food security but have overflowing foodgrains in godowns. Now, there is clarion call to re-orient our research strategies to nutritional security of masses. Maize (*Zea mays* L.) is one of the most important crops worldwide serving as food, livestock feed, and component of industrial products. With its high content of carbohydrates, fats, proteins, some of the important vitamins and minerals, maize has been designated as a ‘poor man’s nutraceutical. Maize group of Plant Breeding and Genetics at Punjab Agricultural University (PAU), Ludhiana is doing concerted efforts to make maize a profitable alternative cereal and an ideal candidate for crop diversification to replace paddy to a certain extent. The keys areas of research are: redesigning of plant type in maize to make it amenable to high plant density; marker assisted conversion of lines with proven heterotic potential to high beta carotene, lysins and tryptophan rich versions; the use of wild resources to infuse resistance for abiotic and biotic stress tolerance; collection of farmers varieties/land races from hilly areas to harness their quality traits to strengthen maize in food sector; optimization of double haploid technology to accelerate line development and innovative approaches to develop high yielding specialty corn hybrids for value addition. To achieve these targets, an association panel of 400 lines of diverse origin have been prepared, harbouring variability for high density amenability traits viz., leaf angle, plant height, anthesis-silking interval and seed yield. PAU has developed a *desi* type composite JC 4 through modified mass selection from local maize collections of rainfed (*kandi*) region of the state. Analysis for *chapatti* making parameters viz., water absorption of 100 g flour (ml); rollability; diameter (cm); appearance; colour; flavour; texture and taste rated JC 4 as ‘very good’ with overall acceptability eight out of 10. A set of four PAU bred maize lines with high seed yield potential and of heterotic vigour were transformed into quality maize lines through marker assisted selection and have been registered by Plant Germplasm Registration Committee (PGRC) of Indian Council of Agricultural Research, India. Maize from hilly/*kandi* regions of India is known to harbour high quality attributes and based on certain environmental and cultural drivers, farmers are retaining and cultivating to some extent. We reported the exploration conducted to collect the land races by visiting different farmers/research stations of different districts of Himachal Pradesh and efforts to harness the untapped native diversity to strengthen maize quality program. PAU also developed new cytoplasmic male sterility (CMS) based babycorn hybrid named Punjab baby corn hybrid 1. In Feb., 2022, this hybrid has been approved for release by State Varietal Release Committee for *kharif* season in Punjab. Manual detasseling of hybrid to obtain good quality baby corns has been emitted which was a major hurdle in adoption of hybrids at mass scale. A set of 175 doubled haploid fixed lines have been developed in a span of two years in comparison to expected 6-7 years through continuous selfing using haploid inducer stocks from CIMMYT, Mexico. A precise phenotypic process has been reported to select water deficit stress tolerant donors through understanding of plasticity in root anatomy using scanning electron microscopy.

Keywords: Maize, hidden hunger, quality protein maize, baby corn, nutraceutical

FORECASTING OF AREA, PRODUCTION, AND PRODUCTIVITY OF SUGARCANE IN INDIA

LOKESH KUMAR AND *PRADEEP MISHRA

¹Department of Mathematics and Statistics, JNKVV, Jabalpur-482 004(India),

²College of Agriculture, Powarkheda, Jawaharlal Nehru Krishi Vishwavidyalaya, Jabalpur-461 110, India

ABSTRACT

Agricultural commodity statistical studies are critical in decision-making portfolios such as government-non-government policies, food security scenarios, economic development management, and so on. The current research study used multiple parametric models and time series models to forecast the nature of wheat area, production, and productivity in India order to obtain the best pattern from available data, which may play an essential role in future forecasting. Prior to analysis, a thorough examination of the work is conducted in order to establish an analysis model that is suitable for the study's aims.

The main purpose is to use the Box- Jenkins methods to examine the series' forecasting nature. The Autoregressive Integrated Moving Average (ARIMA) model is used to build a model and forecast the series for the next year based on its performance. Before employing the ARIMA model for model selection and model validation, the data series were divided into training and testing sets. The best model was chosen based on maximum R^2 , minimum RMSE, MAPE, MAE, and BIC, as well as its fit. The best fitting models for India's area, production, and productivity were found to be ARIMA (1,1,5), ARIMA (1,1,3), and ARIMA (1,1,1), respectively. The autocorrelation function (ACF) and partial autocorrelation function (PACF) plots were used to assess the residual autocorrelation. The plot shows that the chosen model was well-fitting, since the spikes are followed in between the confidence intervals for all series. Following the discovery of the ARIMA model, the data series was forecasted up to 2026. According to the forecast, India will produce 436792.90 thousand tonnes with a productivity of 86.6 tonnes/ha. The usefulness of time series analysis in agricultural commodities has been successfully tested in this research study. This study will indubitably benefit the farmers, policymakers and different stakeholders by delivering accurate forecast information of India. Also, this work will contribute to the immense and speedily growing literature of adaptation of time series analysis on agriculture.

Keywords: ARIMA, Time Series, Forecasting, Production.

MORPHOMETRIC STUDY OF *Oscheius* genera OF KARANPRAGYAG REGION CHAMOLI UTTARAKHAND, INDIA.

SHIKHA THAPLIYAL* NISHA RANA

ABSTRACT

In Karanpragyag region of Chamoli district Uttarakhand, India entomopathogenic nematodes have been found in agricultural fields. *Oscheius* sp. Was determined to be the genus of nematodes based on morphological and morphometric studies. This study is the first, to document this genus in the Karanpragyag area. 20 males, 20 females, and 20 juveniles in the 13th stage were isolated using the Cobb's decanting and sieve method. Males, females and juveniles had total body lengths of 1122 mm, 1354 mm, and 524 mm, respectively.

Additionally, in the future, molecular analysis will reveal the species in the specific region of Karanpragyag from where the *Oscheius* genus had been isolated.

Keywords - Entomopathogenic nematodes, Karanpragyag, *Oscheius*, Cobb's decanting and Sieving Technique.

ROLE OF NANOPARTICLES IN WATER PURIFICATION AND RECLAMATION

AKANSHA BASSI*, NISHA RANA

ABSTRACT

Providing everyone with safe and inexpensive drinking water has become one of the most challenging problems of the 21st century. Considering the drawbacks on conventional water treatment practises, nanotechnology was introduced. Nanotechnology can be defined as the process of altering items on a nano scale. Several nanomaterials are used in the water treatment process. Nanomaterials are materials having structural components ranging (1-100) nm in size. One of the most important applications of nanotechnology is water treatment and remediation where water purification is done with the help of nanomaterials through various mechanisms such as heavy metal's removal, inactivation of pathogens and the conversion of toxic materials into less toxic compounds. Small size and large surface area imparts high reactivity and absorption capacity to nanomaterials. There have been reports of several nanomaterials of removing bacteria and organic annoyances with success. (AgNPs) Silver nanoparticles are very toxic to bacteria, viruses and fungi and have significant antibacterial capabilities therefore silver nanoparticles have been widely used for water disinfection. (AgNPs) bonded to filter materials have been rated promising for water disinfection due to their high antibacterial activity and cost effectiveness. (AgNPs) are also quite effective against E coli. Pollutants such as azodye, Congo red, toulene, dichlorophenol, and others are found successfully removed using TiO₂ based nanotubes. Other nanomaterials are more expensive then TiO₂ nanomaterials. After possible TiO₂ nano particle aggregation with bacterial cells and subsequent sedimentation, the number of bacterial colonies are reduced. At PH=8 heavy metal such as Pb, Cd, Cu, Zn and Ni are found to be absorbed by TiO₂ NPs using aggregation and size dependent colour changes, Au NPs may be utilized as sensors to detect a variety of contaminants including heavy metals, pesticides and put pesticides and pathogenic microorganisms. The creation of new nano photocatalyst should be main emphasis for future research search, it is essential to create novel nano photocatalyst that have high stability, low cost, minimal environmental effect and high efficiency.

Keywords- Nanotechnology, water treatment, nanomaterials, silver nanoparticles, nanocatalysts.

THE MAGNIFICENT ROLE OF METAL, METAL OXIDES AND PLANTS BASED NANOMATERIALS IN BIOREMEDIATION OF POLLUTANTS

**SUGANDHA MISHRA¹, DHIRENDRA KUMAR^{2*}, RAJESH KUMAR SHARMA³,
ASHA SHARMA⁴, AMIT KUMAR DUTTA⁵**

¹Department of Environment Science, Govt. (PG) College for Women, Rohtak, India,

²Department of Botany, Chaudhary Bansi Lal University, Bhiwani, Haryana, India,

³Department of Physics, MNS Govt. College, Bhiwani, Haryana, ⁴Department of Botany, Maharshi Dayanand University, Rohtak, Haryana, ⁵ Amity Institute of Biotechnology, Amity University Jharkhand, Ranchi, India.

ABSTRACT

Nanomaterials are backbone of the rapidly developing field of nanotechnology. Biological synthesis of nanoparticles is a green chemistry approach that interconnects nanotechnology and biotechnology. Biosynthesis of gold, silver, gold-silver alloy, selenium, tellurium, platinum, palladium, silica, titanium, quantum dots and magnetite are reported widely. Nanotechnology has generated interest among researchers due to its beneficial effects, such as its larger surface

area, the capability of multiple uses, its stability at harsh conditions, easy and efficient manipulations in materials, increased interaction, and many more. The integration of different microorganisms and other biomolecules with nanotechnology has provided a greener approach toward the management of pollutants. Due to amazing large surface-to-size ratios and unique surface properties nanoparticles can specifically adsorb to proteins and biomolecules. In fact, size and surface properties of nanoparticles has been found to play a very significant role in determining the adsorption of proteins at nanoparticle surface. In this way nanoparticles made up of even chemically inert materials might prove toxic because of their surface properties. That's why the synthesis of metallic nanoparticles is an active area of more importantly, “application research” in nanotechnology. A variety of chemical and physical procedures could be used for synthesis of metallic nanoparticles. There is an essential need to develop environmentally gentle procedures for synthesis of metallic nanoparticles. The synthesis of metallic nanoparticles is an active area of academic and, more importantly, “application research” in nanotechnology. A variety of chemical and physical procedures are in use for synthesis of metallic nanoparticles. Indeed, over the past several years, plants, algae, fungi, bacteria, and viruses have been used for production of low-cost, energy-efficient, and nontoxic metallic nanoparticles. Nanotechnology integrated with microorganisms. Generation of nanomaterials with the help of microorganisms provides better ways for cost-effective and sustainable effluent remediation.

Keywords: Bioremediation, Green Chemistry, Carbon Nanotubes, Industrial Effluents, Metal Oxides, Phytoremediation

SOIL HEALTH AND CARBON DYNAMICS AS INFLUENCED BY BIOCHAR APPLICATION IN MAIZE GROWN INCEPTISOLS OF KASHMIR

OWAIS ALI WANI, FARIDA AKHTER, SHAKEEL A MIR, RAIHANA H KANTH, Z A BABA, F A PIR, S R DAR

ABSTRACT

The field experiment entitled “Soil Health and Carbon Dynamics as Influenced by Biochar under Maize Grown Inceptisols of Kashmir Valley” was conducted at Sher-e-Kashmir University of Agricultural Sciences and Technology, FoA wadura dring *kharif* season of 2020 and 2021. The experiment was laid out in three factorial RCBD with seven organic amendments (control, apple biochar 400°C, apple biochar 600 °C apple chips, dalweed biochar 400°C, dalweed biochar 600°C, dalweed) and at three rates (low, medium, high) and at two fertilization regimes (no fertilizer and fertilizer). The soil was slightly acidic in reaction and medium in organic carbon, N, P and K with sandy loam texture. Pyrolysis has profound influence on properties of biochar synthesized and the parameters which are greatly affected are pH, EC, Total carbon, CEC, N, P, K and other micronutrients. Biochar yield in case of Apple biochar was 37.50 and 17.00 percent at 400°C and 600°C respectively, while as in case of Dalweed biochar the yield was 47.00 and 37.00 percent at 400°C and 600°C respectively. In case of apple biochar produced at 400°C the pH was 11.70, EC 1.80 (dS/m), CEC 59.00 (meq/100g), while as moisture, ash, volatile matter, fixed carbon, carbon, hydrogen, oxygen, nitrogen, and potassium was 2.10, 7.25, 31.56, 61.19, 73.50, 4.73 16.50, 2.22, 0.33, 0.91 percent, while as in case of dalweed biochar recorded pH 10.60, EC 8.30 (dS/m), CEC 9.60 (meq/100g), whereas moisture, ash, volatile matter, fixed carbon, carbon, hydrogen, oxygen, nitrogen, phosphorus and potassium contents were 4.10, 39.60, 21.60, 38.80, 58.00, 2.90, 18.70, 4.60, 0.39 and 0.11 percent, respectively. Apple derived biochar improved more soil physical properties than Dalweed biochar. Application of biochar and its rate of application improved soil physiochemical properties as well as available nutrients pH and EC increased

with biochar and residues, MWD, BD, porosity and PR were greatly influenced by organic amendments. Soil hydrological properties like MWHC, WC and HC varied significantly. Increase in available nutrients mainly depended on concentration in organic amendments and as well as on rate of application. Maximum improvement in above parameters was observed in A3. Organic residues as well as biochar mediated improvement in soil hydrological properties which influenced crop growth by improving water availability during non-rainy period especially during critical stages. A3 predicted maximum carbon sequestration as is evident by CMI (250.54) and lowest was recorded in A1 (100.00). Rate of application also increased carbon. Apple wood chips as well as Dalweed residue improved soil quality more in 2nd year due to decomposition and in case of fertilisation, its application hastened decomposition rate. Pyrolysis also decreased some of functional groups making residues more appropriate for soil application and also increasing nutrient contents due to loss of mass due to pyrolysis, surface characteristics of biochar and CEC are responsible to improve nutrient holding capacity as well as water holding capacity of biochars applied which makes soil environment feasible for plant growth and development. Soil erodibility is also improved which is key indicator to restore and maintain soil fertility in hilly areas. Carbon sequestration also improved significantly with application of both biochars as well as residues. Apple residue biochar is best suited for physically degraded soils while as Dalweed biochar is recommended for nutritionally poor soils. Thus, the pyrolysis of two wastes that were central to this research is most effective way for sustainable residue management which improves soil health while making farming climate smart and will help to realize the dream of becoming carbon neutral state (UT) of India.

Key words: Biochar, Organic amendments, Erosion, Carbon sequestration, Soil health, Maize.

PROTECTIVE ROLE OF *Spirulina platensis* AGAINST CADMIUM SULPHATE TOXICITY IN THE HISTOPATHOLOGY OF GILLS IN *Clarias batrachus*

PRAGATI¹ AND DR. GARIMA PUNDIR²

Department of Zoology Raghunath Girls Post Graduate College Meerut UP India

ABSTRACT

Heavy metals play a major role among pollutants of environmental concern. Cadmium is a non-essential element with no known biological function. It has many industrial uses such as, cadmium batteries, anti-corrosive coating of metals, pigments, and as stabilizers for plastic. It is black listed by ‘Black list ‘of European Community and is reported as major contaminant of aquatic ecosystem causing adverse effects to aquatic ecosystems. *Clarias batrachus*, which is important food fish in India is contaminated by heavy metal and suffers pathological alterations. Gills are the first target organ of the fishes by any aquatic pollutant. Cadmium sulphate also cause pathological alterations, in Gills of *Clarias batrachus*. *Spirulina platensis* is a cyanobacterium, which is used in many countries as nutritional supplement for human and animal consumption and is labelled as a powerful food which is, rich in proteins, carbohydrates, polyunsaturated fatty acids, Sterols, minerals and vitamins. It has a unique quality to detoxify (neutralize) or to chelate toxic minerals, and this characteristic is not yet noticed in any other microalgae. Protective effects of dietary supplementation of *Spirulina platensis* (SP) in the gills of *Clarias batrachus* against Cadmium Sulphate was elucidated after 30- and 45-days interval of time. Histoarchitectural changes in the gills were assessed. The LC 50 value of Cd was calculated 13.6mg/l. The fishes were divided into three groups, first group is used as control group, second group of fishes treated with Cadmium sulphate and third group treated with *Spirulina platensis* supplemented diet along with Cadmium sulphate. Gills of the fishes of control group showed normal histoarchitectural structure with normal organization of the gill lamellae without any pathological alteration. The gills of the Cadmium treated fishes in group

second showed various histopathological alteration such as hyperplasia of gill epithelium, lifting of epithelium of primary and secondary gill lamellae and necrosis in primary and secondary gill lamellae after 30 days duration of time. These histopathological lesions were more severe after 45 days exposure of time. Gill of the fishes of group third treated with *Spirulina platensis* supplemented diet along with Cadmium sulphate, showed less histopathological lesions as compared with group Second which showed the protective role of *Spirulina platensis*. The results of the present study indicate that dietary *Spirulina platensis* can be recommended as a protective agent against Cadmium Sulphate toxicity in fishes.

Keywords: *Spirulina platensis*, *Clarias batrachus*, Cadmium Sulphate

BETA-GLUCAN FROM EDIBLE MUSHROOMS AS FUNCTIONAL BIOMATERIAL

SUHANI SAJAD* AND JAGMOHAN SINGH

Department of Food Science & Technology, Sher-e-Kashmir University of Agricultural Sciences & Technology of Jammu, 180009, India

ABSTRACT

Edible mushrooms are important constituents of our daily diet due to their rich nutrition and beneficial properties for human health. Polysaccharides, the main component of edible mushrooms, attracted more and more attention because of their complex structure and diverse biological activities. Health-promoting β -glucans are an auspicious group of polysaccharides. β -glucans are major bioactive compounds known to have biological activities including anticancer, anti-inflammatory, and immune-modulating properties. β -glucans from different sources such as cereals, yeast and grass have previously been documented. However, information on mushroom β -glucan is limited. They have been widely regarded as a natural source for functional foods and pharmaceuticals. Due to the specific physical properties of β -glucans, such as water solubility, viscosity, and gelation, it has been increasingly used by the food and other industries. However, the physico-chemically stable and biocompatible properties of β -glucans are rarely explored as a coating material for nanomaterials to overcome the problems of aggregation and cytotoxicity. The aim of this review article is to present an overview on the exploration of β -glucans, in particular those derived from mushrooms, as a natural coating material to modify the surface properties of bioactive substances as a relatively simple and cost-effective strategy to produce stable and biocompatible nanohybrids used for biopharmaceutical use. It is envisaged that such β -glucan based coating method will provide new opportunities to design biocompatible functional nanomaterials for wider clinical applications. Furthermore, the physicochemical properties, chemical modifications, possible industrial applications and future prospects of β -glucans in foods, medicines and other potential value-added products are also summarized.

Key words: β -Glucan, Functional food, Biocompatibility, Pharmaceutical, Industrial application.

EFFECT OF RICE HUSK ASH ON CONTROLLING STORAGE INSECT PESTS OF PIGEON PEA

M.S. SINGH, TABULIU ABONMAI AND KSH. MANISHWARI DEVI
College of Agriculture, Central Agricultural University-Imphal

ABSTRACT

An experiment was conducted at Department of Agronomy, College of Agriculture, CAU, Imphal during 2017-2018 to study the "Effect of rice husk ash on controlling storage insect pests of pigeon pea". It was observed that when the seeds were mixed with rice husk ash properly and stored in a polythene bag for one year at the rate of 300g rice husk ash and above per kilogram of pigeon pea seeds, there was no insect pest attack on the seeds. But in control where no rice husk ash was mixed, after one year of storage, all the seeds were affected by the insect pests. Based on this study, rice husk ash has potential for refinement into an effective protectant for management of stored insect pests.

Keywords: Pigeon pea, rice husk ash, insect pests

A COMPARATIVE STUDY ON PROTEIN, IRON AND ZINC CONTENT ON CERTAIN RED RICE CULTIVARS OF MANIPUR

TABULIU ABONMAI, M.S SINGH AND KSH. MANISHWARI DEVI
College of Agriculture, Central Agricultural University-Imphal

ABSTRACT

Twelve red rice local cultivars from different districts of Manipur were studied for their protein, iron and zinc content. Pigmented rice (red and black rice) is widely known as enriched rice with a unique taste and health improvements. Red rice has a nutritional value more than that of milled and or polished rice. Red rice has a very high nutritional value with a good source of minerals and antioxidants which help in preventing and curing several diseases. In particular, red rice are known to be rich in iron and zinc content. Highest total protein content was found in the cultivar Cha Neng. The results showed that the iron content of pigmented rice was highest in Beng Neng and the highest Zn content was found in the cultivar Mariumi Kahengbo. It further indicates that most of the waxy cultivars showed higher iron content.

Keywords: Red rice, nutrient, protein, iron, zinc

EFFECT OF SEASONING D ON SOME SERUM KIDNEY FUNCTION PARAMETERS

¹ABDULMUTALIB A., ¹A.Y ABBAS, ²SALAUDEEN A.A. AND ¹ABDULJALAL A

¹Usmanu Danfodiyo University

²Abdu Gusau Polytechnic, Talata Mafara

Purpose:

In the present world, the rate at which seasonings are used in meal preparation is alarming, with the negligence in the effect it exerts to the system. About 80% of the meal, we consume today contain high amount of chemically composed seasonings which is said to cause some changes in the concentration of some biochemical co-factors, this leading to some defects, hyperactive metabolic process or deficient metabolic product. Hence, this study is to assess its safety. The research was primarily based on how seasoning D affects urea, uric acid and creatinine to which albino rats were used. The percentage weight change was also ascertained.

Method:

The weight of all host albino rats was measured weekly during the administration of seasoning D in accordance with their respective groups.

The blood sample were also extracted after the whole process and subjected to laboratory analysis using standard method. The concentration of these parameters was analysed in accordance to difference in the dosage administered.

Results: The percentage body weight reduced with increase in concentration of seasoning D administration. Moreover, the studied parameters were seen to decrease in concentration with increase in dosage of seasoning D.

Conclusion:

The present study provides an insight on the effect of seasoning D on urea, uric acid and creatinine. With reference to the obtained result, seasoning D is considered not to exert any adverse effect on the studied kidney function parameters thereby considered safe for consumption.

Keywords: Urea, Uric Acid, Creatinine, Seasoning D, Albino rats

NUTRITIONAL STATUS OF DRAGON FRUIT

BHAVANA DHAKER*, RAJA RAM BUNKER **

* Department of Horticulture, CoA,SKRAU-Bikaner Rajasthan

** Department of Horticulture, RCA,MPUAT, Udaipur, Rajasthan

ABSTRACT

Dragon fruit is a low-calorie fruit that contains less sugar and fewer carbs than many other tropical fruits. These are some of the main antioxidants contained in dragon fruit pulp. Free radicals are unstable molecules that cause cell damage, which may lead to inflammation and disease. One way to combat this is by eating antioxidant-rich foods like dragon fruit. Antioxidants work by neutralizing free radicals, thus preventing cell damage and inflammation. Studies suggest that diets high in antioxidants may help prevent chronic diseases such as heart disease, cancer, diabetes and arthritis. Vitamin C: Observational studies have found correlations between vitamin C intake and cancer risk. For example, a study in 120,852 people associated higher intakes of vitamin C with lower rates of head and neck cancer. Betalains: Test-tube studies indicate betalains can combat oxidative stress and may have the ability to suppress cancer cells. Carotenoids: Beta-carotene and lycopene are the plant pigments that give dragon fruit its vibrant color. Diets rich in carotenoids have been linked to a reduced risk of cancer and heart disease.

Keywords- Dragon fruit, antioxidant, betalains etc.

MECHANISMS OF POLLINATION AND BREEDING OBJECTIVE OF GLADIOLUS

MANISHA VERMA AND RAJA RAM BUNKER

Department of Horticulture, Rajasthan College of Agriculture, MPUAT, Udaipur (Raj.)

ABSTRACT

The stamen and stigma's arrangement and structure indicate that Gladiolus is basically an outbred species. Anthesis takes place between 8:15 and 10:15 hours, and another dehiscence follows shortly after. Nearly 1 1/2 hours after another dehiscence, the stigma becomes responsive. Only hand-pollinated flowers indicated the maximum pod development, whereas naturally cross-pollinated and bagged flowers showed a significant loss in pod development. *Apis indica* is a common flower visitor that enters through the tube to obtain nectar or may land

directly on the anthers to gather pollen. Three taxa, including the element species *G. tristis*, have self-incompatibility. From completely self-incompatible to highly self-incompatible cultivars, there is a graded series. Outcrossing is suggested by floral biology and the presence of self-incompatibility. Despite their hybrid origins, all of the cultivars show a consistent breeding process.

Keywords: Anthesis, flowers, hybrid, breeding, pollination etc.

SEASONAL INCIDENCE OF GRIDLE BEETLE (*Obereopsis brevis*) IN SOYBEAN [*Glycine max (L.) Merrill*]

DEVESH PARMAR¹, J. KAVIPRIYA²

Department of Entomology, Rajasthan College of Agriculture, Maharana Pratap University of Agriculture and Technology, Udaipur, Rajasthan-313 001, India.

Department of Nematology, Rajasthan College of Agriculture, Maharana Pratap University of Agriculture and Technology, Udaipur, Rajasthan-313 001, India.

ABSTRACT

A significant oilseed crop with excellent nutritional value, soybean [*Glycine max (L.) Merrill*] containing 43% protein and 20% edible oil. The crop is infested by more than 275 insect pests on various plant parts. *Obereopsis brevis*, one of these girdle beetles, is the predominant pest of the soybean crop. When the crop was 30 days old and in the third week of August 2021, the girdle beetle infestation (*Obereopsis brevis*) began. It lasted until the fourth week of September 2021. 0.80 percent of the plants had an initial infection. But in the third and fourth weeks of August, the infestation drastically increased to 1.20 and 2.7 percent, respectively. From 4.8 to 28.7 percent, with the highest percentage in the second week of September 2021, an additional increase in infestation was noted. Infestation of plants began to decline in the third week of September, and it continued to do so through the fourth week (12.5 and 2.00 percent respectively). After that, the crop reached maturity and was harvested on October 20, 2021. So, from the third week of August to the fourth week of September, the pest was active. The adult female girdled the stem, branch, petiole, and petiolet made three holes near the proximal ring for egg laying. During the second week of August, the frequency of girdling was detected on the stem (1%), followed by the petiole (2%), and the petiolet (2%), although the branches and petiolet were not offered for girdling during this period. The petiole (9%) and petiolet (16%) showed the highest frequency of girdling in the second week of September, and the infestation persisted into the third and fourth weeks. However, during the last week of September, there was a 4 percent rise in the incidence of girdling on petiolet. This might be described by the branches' relative succulence to the stem. The highest intergirdle length of 14.5 mm was observed in the second week of September, and the maximum distance of the egg hole from the proximal girdle was 3.5 mm.

Key words: Soybean, Seasonal incidence, Gridle beetle

ORGANIC FARMING - A NEED FOR HEALTHY ECOSYSTEM

PRATIBHA AND MANISHA VERMA

Department of Horticulture, Rajasthan College of Agriculture, MPAUT, Udaipur (Raj).

ABSTRACT

Agriculture became a high investing and low yielding due to uncontrolled use of synthetic chemicals which are becoming harmful to the ecosystem. To protect our ecosystem organic farming is well practiced without using harmful chemicals, they are replaced by bio-fertilizers, bio-pesticides etc. Organic farming works in harmony with nature rather than against it. This involves using techniques to achieve good crop yields without harming the natural environment or the people who live and work in it. An organic farmer produces vegetables, fruit, cereal crops, or livestock without the use of chemical fertilizers, pesticides, or herbicides. In another way organic farming is kind of agricultural that provide the consumers, with fresh, tasty and reliable food while regarding natural life cycle systems. In addition to health benefits of organic products for consumers, there are vital environmental benefits for the earth. An organic farming keeps biodiversity healthy and reduce environmental pollutions such air, water and soil. In today's time there is a great need for organic farming becoz of It helps to maintain environment health by reducing the level of pollution. It reduces human and animal health hazards by reducing the level of residues in the product. It helps in keeping agricultural production at a sustainable level. It reduces the cost of agricultural production and also improves the soil health.

Keywords: Organic Farming, Biofertilizers, Ecosystem.

INTRODUCTION OF *GMELINA ARBOREA* BASED AGROFORESTRY IN EASTERN UTTAR PRADESH (INDIA)

ANUBHA SRIVASTAV & RAMBIR SINGH*

Forest Research Centre for Eco-rehabilitation, Prayagraj

*Forest Research Institute, Dehradun

ABSTRACT

Agroforestry as a traditional land-use adaptation may potentially support livelihoods improvement through simultaneous production of timber, food, fodder and firewood as well as mitigation of the impact of climate change. Tree-Crop interaction is an important aspect in Agroforestry where trees are grown in association with crops. In Eastern part of Uttar Pradesh, species like, *Tectona grandis*, *Eucalyptus sp.*, *Poplar sp.* are well established commercially. But more options of species selection in agroforestry systems are urgently needed to strengthen species diversity and rural livelihood in the region. Several studies in different parts of the country suggested that agroforestry is more profitable to farmers than agriculture or forestry for a particular area of land. Thus, with a view to introduce *Gmelina arborea* (Gamhar), which is successful species in other parts of the country, was established in agroforestry models in different crop combinations in block (4x5 & 5x5 m) and bunds (1-3 m) on alkaline soil (pH 8.5) of Prayagraj district. *Gmelina arborea* in dry areas of these states can grow well by tall planting, about 6-7 months aged plants with proper silvicultural practices. The economics of estimated B:C ratio & net profits of *Gmelina arborea* based agroforestry models in 8 years rotation were estimated and found maximum to be (3.29 & Rs.19.15 L) in model-1 (Gmelina-Agri at 4x5m) followed by model-2 (Gmelina-Agri at 5x5m) with (3.13 & Rs.17.54 L), model-3 (Gmelina-Agri+ vegetables on bund) with (2.99 & Rs.19.09 L) respectively. The bund-based agroforestry is more popular in the eastern part of Uttar Pradesh due to marginal land holding.

The *Gmelina arborea* (white Sagaun), a introductory species in the region can replace Teak due to its fast growth, easy establishment in fields and good returns in shorter period of time for rural livelihood. The timber and roots are most important part of this species, thus, can be well utilized commercially in wood/plywood/veneer and medicinal/ayurvedic industries for preparation of Dashmoolarisht.

Keywords: Agroforestry, *Gmelina arborea*, commercial value, introduction, rural livelihood

EFFECTS OF MALARIA PARASITE ON COMPLETE BLOOD COUNT

SWATI¹, SANCHITA PAL², AANCHAL¹

¹Department of Medical laboratory Technology Motherhood University, Roorkee.

²Department of Microbiology Motherhood University, Roorkee.

ABSTRACT

Malaria continues to be a major health problem in some of the most populated areas of the world. Malaria is one of the most serious and widespread parasitic disease of humans. It is caused by protozoa parasite of the genus plasmodium which infects and destroys red blood cells. Four species of plasmodia (*P. falciparum*, *P. malariae*, *P. ovale* and *P. vivax*) cause malaria in humans. survival advantage against malaria, inherited red cell disorders are the most common monogenic diseases affecting over a billion people globally. Each year, more than 500 million people are infected with malaria parasites and half a million (predominantly infants and young children) die as a consequence of the infection. Plasmodium species infection in stained thick and thin blood films. Hematological parameters were obtained by analyzing EDTA blood samples, using automated hematological analyzer system (Sysmex-KX2IN). hematological abnormalities that have been reported to invariably accompany infection with malaria include anemia, thrombocytopenia, splenomegaly, mild-to-moderate atypical lymphocytosis and rarely disseminated intravascular coagulation (DIC)The clinical symptoms of malaria are manifested when parasites invade and multiply inside human red cells. These effects facilitate survival of the parasite within the host cell and tend to increase the virulence of disease that include cerebral malaria and anemia. Numerous proteins secreted by the internalized parasite and interaction with red cell membrane proteins are responsible for the changes occurring to the host cell. Anemia a serious clinical manifestation of malaria is due to increased destruction of both infected and uninfected red cells due to membrane alterations, as well as ineffective erythropoiesis. There is very good evidence that various red cell disorders including hemoglobinopathies and hereditary ovalocytosis decrease the virulence of disease following parasite infection.

Keywords: plasmodium. *falciparum*, plasmodium. *malariae*, plasmodium. *ovale* and plasmodium *vivax*.

FACTORS ASSOCIATED WITH ANEMIA

AVDHESH KAMBOJ¹, SANCHITA PAL², AESHA KAMBOJ³

¹Department of medical laboratory Technology National Paramedical group of institute chandausi.

²Department of Microbiology Motherhood University Roorkee.

³Department of medical laboratory Technology Motherhood university Roorkee

ABSTRACT

Anemia is a major public health problem particularly affects young children. Anemia is not a disease but an objective sign of disease and needs further evaluation to determine the

underlying cause and appropriate treatment. All living things contain inside their bodies which serves many function like blood act as important connective tissue in transport of oxygen to the all cells. Anemia is defined as a reduction in Haemoglobin concentration below the level, which is expected for healthy persons of same age & sex, and in the same environment. haemoglobin is the carrier protein for oxygen, adequate oxygen cannot be delivered to various organs and tissues due to low oxygen carrying capacity of blood and hypoxia condition occurs which leads to major symptoms like fatigue, weakness, dizziness & shortness of breath. Anaemia may be caused by two major mechanisms. Decreased production of RBCs and increased destruction of RBCs (hemolytic anemia). There are two main ways of classifying anemia. In the First stage of iron deficiency, iron stores are depleted without declining the iron levels in the blood and in second stage normal blood formation take place but metabolism at the cellular level is affected which lead to effect on the nervous system. Treatments for anemia depends on the cause, range from taking supplements to having medical procedures. Many types of anemia cannot be prevented, but some anemia like deficiency anemia (IDA, Megaloblastic anemia) can be avoided by eating a balanced diet. Interavenous therapy was safe, convenient and more effective than intramuscular iron therapy, in treating iron deficiency anemia.

Keywords: Red blood cells, haemoglobin, Intramuscular, Intravenous.

BRUCELLOSIS: AN OVERVIEW

AANCHAL¹ SANCHITA PAL²

¹Department of Medical laboratory Technology Motherhood University, Roorkee.

²Department of Microbiology Motherhood University, Roorkee.

ABSTRACT

Brucellosis is a bacterial infection that spreads from animals to people. brucellosis is still a serious zoonotic disease. The ecological range of *Brucella* has been expanded recently due to the isolation of different strains from marine mammals. Even though *Brucella abortus* has been eradicated from cattle in many nations, *Brucella melitensis* has started to infect cattle in some regions, as well as sheep and goats. Malta fever is a highly contagious disease caused by bacteria of the *Brucella* species. It is also called Mediterranean fever. It is transmitted to humans by domesticated animals, such as cattle, dogs or pigs. It can be transmitted by drinking milk, eating meat or coming in contact with their secretions of these infected animals. Fever, sweating, lethargy and body aches occur in the acute phase of the disease and sometimes it continues for months in a chronic form. In most of the animal species, the disease primarily affects the reproductive system with concomitant loss in productivity. Three species of *Brucella* are known, which are found in three species of animals: *Brucella melitensis* in goat, *Brucella suis* in pig and *Brucella. Abortus* in cattle. The incubation period is 5 to 21 days. Sometimes it takes 6 to 9 months for the symptoms of the disease to become visible. The immunological response to *Brucella* infection involves both humoral and cellular immune responses. Clinical symptoms of *Brucella* infection are non-pathognomonic, hence laboratory testing are mostly used to determine the disease's diagnosis. The conventional tests, viz. Rose Bengal plate agglutination test (RBPT), serum tube agglutination test (SAT) and complement fixation test (CFT) are commonly used. Isolation is still the gold standard. Other commonly used tests are enzyme linked immunosorbent assay (ELISA), polymerase chain reaction (PCR), native hapten (NH) gel precipitation tests, brucellin skin test and fluorescence polarization assay (FPA).

Keywords: *Brucella melitensis*, *Brucella suis*, *Brucella Abortus* in cattle. enzyme linked immunosorbent assay, complement fixation test, Bengal plate agglutination test, fluorescence polarization assay

NATIONAL EDUCATION POLICY 1986 & NATIONAL EDUCATION POLICY 2020: AN INSIGHT THROUGH COMPARATIVE ANALYSIS

SUDHANAND PRASAD LAL^{1*} AND MALLELA BANDHAVYA²

¹PG Department of Extension Education (PGCA), Dr Rajendra Prasad Central Agricultural University, Pusa, Samastipur, Bihar- 848125, India

²Department of Agricultural Extension, S.V. Agricultural College, Tirupati-517502, (Acharya N.G. Ranga Agricultural University, Andhra Pradesh), India.

ABSTRACT

Any nation's growth and development have been greatly aided by education. Education determines a nation's future prosperity and that of its students. The most powerful tool available to use in the fight to transform the world is education. At the school and university levels, an effective, progressive education policy is essential because education promotes any country's economic and social development. In the 21st century, a key reform that took place recently in India was the development of the National Education Policy (NEP) 2020, which the Indian Cabinet approved on July 29, 2020. The Government of India announced its unique education rules, based on recommendations made by Dr. Krishnaswamy Kasturirangan (expert committee head), a former chairman of the ISRO, to accelerate the development of the Indian education sector. The first NEP was conceptualized in 1968, 2nd in 1986, and the central government conceptualized 3rd NEP in 2020. The National Education Policy of 1986's main goal was to create courses with a standardized framework, a common core, and extra-stretchy components. The National Education Policy-2020 emphasizes a thorough approach to multidisciplinary courses and gives students a wide range of options to choose the subjects that interest them the most. In NEP-1986 common education structure of 10 (5+3+2)+2+3+2 was followed, while in 2020 Common education structure of 5+3+3+4+4+1 is recommended. The scope of this plan is wider, starting with elementary school education (literacy level) and continuing through higher education (specialist focus), incorporating both rural and urban settings. The three major objectives of the new education policy are to maximize superiority, impartiality, and truthfulness throughout the entire educational system, from elementary school to post-secondary education. Reducing the number of pupils enrolled in the core curriculum and allowing them to be more "inter-disciplinary" and "multilingual" is the main goal of the new policy.

Keywords: Comparative analysis, HEIs, National Education Policy 1986, National education policy 2020, National Research Foundation.

ORGANIC FARMING WITH RESIDUE-FREE PRODUCTION

MADHUBALA KURMANCHALI*, AKSHIT KUKRETI**

***Department of Genetics and Plant Breeding, Govind Ballabh Pant University of Agriculture and Technology, Pantnagar (U.K.), India**

**** Department of Agricultural Sciences, Maya college of Agriculture and Technology, Selaqui, Dehradun**

ABSTRACT

Despite conventional farming, which shows high dependency on use of synthetic chemical fertilizers and pesticides, organic farming prohibits on farm use of synthetic fertilizers and pesticides and also has the potential for sustainable agriculture which is capable of maintaining land productivity and useful to society over the long run. Organic farming serves conventional higher yield stability, improved soil fertility, higher yields and profitability, lower external

input use, reclamation of degraded land, improved market access, and improved capacity of farmers to use indigenous knowledge, self-reliance in agricultural production and also conserve global biodiversity with maintaining food security; a critical challenge with ever fast growing population. In the present era organic and residue-free farming are the hot topics for food safety. Residue-free farming is a farming system of protection and growth enhancement of seedlings and plants by the application of organically derived bio-fertilizers and biocides. This farming system adopts a much wider scope with the employment of modern farming techniques viz; bio-fertilizer management, grafting, polyhouses, rainwater harvesting etc. Residue farming can be seen as a modern adaptation of organic farming not only maintains but also improves the productivity of the soil without hampering the production capacity and produce high nutritional value food crop for health conscious consumers. In today’s health-conscious food industry, both organic and residue-free farming have their space. Buyers are opting for produce with minimal chemical traces and high nutrition value. So organic farming with residue free production offers a more cost-effective and sustainable alternative and is more viable approach for large-scale farming of quality food. This farming practice is a harbinger of a greener, cleaner and healthier agricultural sector.

CLIMATE-SMART AGRICULTURE WITH AN EMPHASIS ON MITIGATING THE IMPACTS OF CLIMATE CHANGE ON AGRICULTURE AND FOOD SECURITY.

OSMAN ALI, DEBLINA ROY, SUCHANDRA NEOGI

**Department of Agronomy, Faculty of Agriculture, Bidhan Chandra Krishi
Viswavidyalaya, Mohanpur-741252, West Bengal**

ABSTRACT

Indian agriculture has made rapid strides in improving food production and the country has become not only self-sufficient in food production, but now exports to several other countries as well, but currently, it is facing many challenges. Stagnating net sown area, plateauing yield levels, deterioration of soil quality, reduction in per capita land availability, and the adverse effect of climate change are the major challenges for Indian agriculture. Since agriculture in India is incredibly weather- and climate-dependent, due to extreme weather and unique meteorological circumstances, the nation has experienced a significant loss in crop production. Future agricultural production in the nation is anticipated to be significantly impacted by significant variations in the weather and climatic characteristics, as predicted in the Global Circulation Model Climate Change experiments. So, declining agricultural productivity is associated with food security and climate change could thus have far-reaching effects on the patterns of trade among nations, development, and food security. To cope up with climate change more effectively, crops have to cope with increased variability of weather, extreme events, and changing climate patterns throughout the growing season. A practical strategy for guaranteeing food security in a changing environment is climate-smart agriculture. Climate-smart agriculture is an agricultural practice that sustainably boosts production, builds resilience, reduces greenhouse gas emissions, and improves the attainment of targeted goals and national food security. The effects of climate change can be mitigated through adaptation techniques built on the tenets of climate-smart agriculture, such as the promotion of conservation agriculture, sustainable resource management, and climate-smart crops.

Keywords: - Climate-smart agriculture, climate-change, food-security.

EVALUATION OF VARIABILITY IN SOIL PROPERTIES INFLUENCING PIGEONPEA (*Cajanus cajan L.*) YIELD: A MULTIVARIATE STATISTICAL APPROACH

VIJAYA B. WALI, RAJESH N.L.

Purpose

The aim of the study was to reveal the variability in soil properties influencing pigeon pea (*Cajanus cajan L.*) seed yield under semi-arid rainfed condition.

Methods

Secondary data on soil properties and yield of pigeon pea for two site years viz., 2018-19 and 2019-20 was collected, where the soils were initially classified into series level and further these series were divided into soil phase units. Surface soil samples from each soil phase units were collected before sowing of pigeon pea and subsequently crop growth parameters at critical stages were collected by the soil scientists. Principal component analysis (PCA) is used as a dimension reduction technique and it is an extremely powerful technique often used to indicate the significance and non-significance of specific variables influencing crop yield. Therefore, in the present study both physico-chemical properties and crop growth parameters were subjected to PCA and resulting components were subjected to stepwise linear regression analysis to check the significant effect of soil properties on crop yield.

Results

The principal component analysis with varimax rotation resulted in five components for both the site years having eigenvalues greater than one explained more than 80 percent of variability. The stepwise linear regression analysis showed that the pigeon pea seed yield was linearly correlated with PC1 ($P < 0.01$), PC2 ($P < 0.01$), and PC4 ($P < 0.05$) of soil properties with $R^2 = 0.767$ during 2018-19, whereas during 2019-20 the seed yield was linearly correlated with PC1 ($P < 0.01$), PC2 ($P < 0.01$), and PC5 ($P < 0.05$) of the soil properties with $R^2 = 0.692$. In site year 1 Fe, Zn, Cu, Mn, Ca, P, K, Mg determined the yield. In site year 2, Fe N, P, Cu, Zn, Mg, and clay determined the yield.

Conclusions:

The principal component analysis performs a reasonable dimension reduction and operates well with highly correlated variables, therefore all the PC's with high cumulative variance should be considered for principal component regression analysis. In site year 1 Fe, Zn, Cu, Mn, Ca, P, K, Mg and in site year 2, Fe N, P, Cu, Zn, Mg, and clay which were identified from principal component regression analysis can effectively explain the yield variability and need to be applied in site specific way to increase the crop yield.

Keywords: Principal component analysis, Stepwise regression analysis, Variability in soil properties, Yield

ORGANIC FARMING - A NEED FOR HEALTHY ECOSYSTEM

PRATIBHA AND MANISHA VERMA

Department of Horticulture, Rajasthan College of Agriculture, MPAUT, Udaipur (Raj).

ABSTRACT

Agriculture became a high investing and low yielding due to uncontrolled use of synthetic chemicals which are becoming harmful to the ecosystem. To protect our ecosystem organic farming is well practiced without using harmful chemicals, they are replaced by bio-fertilizers, bio-pesticides etc. Organic farming works in harmony with nature rather than against it. This involves using techniques to achieve good crop yields without harming the natural environment

or the people who live and work in it. An organic farmer produces vegetables, fruit, cereal crops, or livestock without the use of chemical fertilizers, pesticides, or herbicides. In another way organic farming is kind of agricultural that provide the consumers, with fresh, tasty and reliable food while regarding natural life cycle systems. In addition to health benefits of organic products for consumers, there are vital environmental benefits for the earth. An organic farming keeps biodiversity healthy and reduce environmental pollutions such air, water and soil. In today's time there is a great need for organic farming becoz of It helps to maintain environment health by reducing the level of pollution. It reduces human and animal health hazards by reducing the level of residues in the product. It helps in keeping agricultural production at a sustainable level. It reduces the cost of agricultural production and also improves the soil health.

Keywords: Organic Farming, Biofertilizers, Ecosystem.

EFFECT OF FEEDING HYDROPONIC HORSEGRAM SPROUTS ON GROWTH PERFORMANCE OF KONKAN KANYAL GOATS

DIVYA KOKANI^{1*}, B. G. DESAI², D. J. BHAGAT², V. S. DANDEKAR³, J. S. DHEKALE³

Department of Animal Husbandry and Dairy Science, College of Agriculture Dapoli, Dr. Balasaheb Sawant Konkan Krishi Vidyapeeth Dapoli, dist-Ratnagiri, Maharashtra, India.

ABSTRACT

An experiment was conducted to study the effect of feeding hydroponic horse gram sprouts on growth performance of goats. Twenty Konkan Kanyal goats (4 to 6 months old) were divided into four groups and fed hydroponic horse gram sprouts *viz.*, T₁ (0%), T₂ (15%), T₃ (30%) and T₄ (45%). The result of study showed that daily dry matter intake was significantly ($p < 0.05$) higher in T₃ (667.02g) than T₁ (619.36g), T₂ (654.73), T₃ (663.59g). Digestible crude protein (g/d) and metabolizable energy (MJ/d) intake of kids was 38.28 and 4.32 in T₁, 38.36 and 4.50 in T₂, 38.50 and 4.54 in T₃ and 38.73 and 4.77 in T₄ respectively. Average daily gain was higher in T₃ (91.24g) than T₁ (85.73g), T₂ (90.89g) and T₄ (90.19g). The feed cost per kg live weight gain (Rs) was 50.71 in T₁, 65.68 in T₂, 81.97 in T₃ and 85.23 in T₄. Therefore, it is concluded that 15% horse gram sprouts with 85% basal feed found beneficial for higher growth performance and economic profitability in goats.

SOCIO-ECONOMIC PROFILE OF STAKEHOLDERS OF NATIONAL AGRICULTURE MARKET (e-NAM)

MALLELA BANDHAVYA^{1*}, ASHOK KUMAR SINGH², SUDHANAND PRASAD LAL³ AND GYAN SHUKLA⁴

¹Department of Agricultural Extension, S.V. Agricultural College, Tirupati-517502, (Acharya N.G. Ranga Agricultural University, Andhra Pradesh), India.

^{2,3}Post Graduate Department of Extension Education, Dr. Rajendra Prasad Central Agricultural University, Pusa (Samastipur) Bihar-848125(India)

⁴Benaras Hindu University, Varansi, UP.

ABSTRACT

The present study covered the Guntur mandi of Andhra Pradesh as it was the top mandi in Andhra Pradesh in trade volume and value of transactions through e-NAM. This study was undertaken to analyse the socio-economic profile of the stakeholders of e-NAM. The ex- post

facto research design was adopted. The sample size was 100. A pre-tested interview schedule was used. Data were collected from five different stakeholders: 30 Farmers, 30 Traders, 5 FPOs, 25 Commission agents, and 10 e-NAM officials selected based on the disproportionate stratified random sampling method. It was discovered that the majority of farmers, traders, and commission agents were middle-aged individuals with small families. The majority of farmers (70%) were found to be in the 36 to 50 age range, had small families (5 members), had secondary or intermediate education, not belong to any social organisation (86.6%) in the study area, engaged in crop cultivation alone (66.6%) with large land-holding (66.7%), had a medium level of annual family income (₹327450), and had medium level of extension education (63.3 percent). A total of 12 explanatory variables of the farmer have been considered for regression analysis out of which Scientific orientation was positively significant at a 1%, land-holding is negatively significant at a 1%, while social participation and annual family income were found significant at a 5%. The remaining variables were found non-significant. Multiple linear regression analysis portrayed that all the selected variables put together accounted for 79.60% variation in the performance of e-NAM. The majority of the traders were middle-aged (53%) and had small families. They also pursued secondary/intermediate education (53.3%) and had average yearly household incomes (₹401333.3). The majority of the commission agents were middle-aged (40%) and had small families. They had pursued primary or middle school education (32%), and their annual family income was around ₹492600. The majority of e-NAM officials were middle-aged (40%) and had small families. They also had graduation-level education (40%) and a moderately high annual family income (₹130700). The average age of traders was more than commission agents and farmers, whereas the family size of farmers was more than commission agents and traders. Commission agents had more average annual family income than other stakeholders, traders, farmers, and e-NAM officials. The illiterate percent was more among farmers than traders, commission agents, and e-NAM officials.

Keywords: e-NAM, Market-led extension, National Agriculture Market, Online marketing, Stakeholders, socio-economic and personal profile.

USE OF MULTILINE AND MIXED CULTIVAR FOR PESTS MANAGEMENT IN HILL FARMING SYSTEM

B. TUDU, B. PATRA, B. R. SHARMA, H. K. TARAFDER S. BASKEY, S. GURUNG, S. ALI AND T. S. GHIMIRAY

**Regional Research Station (Hill Zone), Uttar Banga Krishi Viswavidyalaya
Kalimpong, West Bengal, India, PIN – 734301**

ABSTRACT

Hill and upland Agriculture, Agro-forestry and Horticultural Ecosystems are Organic in nature by default. In recent years, there has been an increase in health concerns among consumers. The demand for organic agricultural products produced is on the constant increase worldwide as consumers are shunning the use of chemical fertilizers and pesticides. Apart from increasing total farm productivity, multiline and mixed cultivars cropping can bring many important benefits such as improvement of soil fertility management, on-farm biodiversity and suppression of pests and/or diseases. In this sense it can be seen as performing different eco-services in the farm system. This concept notes discuss intercropping of multiline and mixed cultivars in this context while focusing on its potential and actual use as a tool to manage pests and diseases in conservation agriculture ecosystem.

Keywords: Multiline, mixed cultivars, biodiversity, pest management

ROLE OF MELATONIN IN GASTRO INTESTINAL TRACT

ARVIND KUMAR PATHAK¹, SANCHITA PAL², VINAY YADAV¹

¹Department of Biochemistry Sai Institute paramedical and Allied sciences Dehradun, Uttarakhand.

²Department of Microbiology, Motherhood University Roorkee, Uttarakhand.

ABSTRACT

Melatonin, an indole formed enzymatically from L-tryptophan, is the most versatile and ubiquitous hormone molecule produced not only in all animals but also in some plants. The focus of this review is on the function of melatonin in the upper GIT gastro intestinal tract, which includes the mouth, oesophagus, stomach, and duodenum. Here, indole is produced, released into the GIT lumen, and the portal circulation, where it is taken up by the liver, processed, and then released into the duodenum. Originally identified in pinealocytes, the biosynthetic steps of melatonin involve two major rate-limiting enzymes, arylalkylamine-N-acetyltransferase and hydroxyindole-o-methyltransferase. These enzymes have also been found in entero-endocrine cells of the GIT wall, where they may act via endocrine, paracrine, or luminal pathways through G-protein coupled receptors. Melatonin production in the GIT was found to be 500 times greater than that in the pineal gland. Melatonin production by the pineal gland has a circadian cycle with a significant night time peak, particularly in younger age, followed by the entire process throughout the daytime. Due to its high lipophilicity, melatonin levels drop while blood concentrations during the day are reduced but maintained, primarily as a result of its release from the GIT. Intact and Pinealectomized animals showed an increase in plasma melatonin following oral administration of tryptophan, suggesting that extrapineal sources such as circadian entrainment, free radical scavenging activity, and protection of mucosa against various GIT lesions like stomatitis, esophagitis, gastritis, and peptic ulcer may also be involved. The production of melatonin in the upper GIT.

Key words: Melatonin, Tryptophan, G-Protein, Gastro Intestinal Tract.

A REVIEW OF METHICILLIN RESISTANT *Staphylococcus Aureus*

Aesha kamboj¹, Sanchita Pal², Avdhesh Kamboj³

¹Department of Medical laboratory Technology Motherhood university Roorkee.

²Department of Microbiology Motherhood University Roorkee.

³ Department of Medical laboratory Technology National Paramedical group of Institute Chandausi.

ABSTRACT

MRSA is a strain of *Staphylococcus aureus* which is gram positive & facultative anaerobic bacteria. Selective media used for isolation of MRSA is Mannitol Salt Agar or Baird-Parker Agar. MRSA contains a new gene, encoding a protein (Mec A) present in cell wall of MRSA. Antibiotics like penicillin & Methicillin do not bind to Mec A, so they cannot kill the bacteria. MRSA is a pathogen of public health importance and leading cause of bacteraemia, endocarditis, skin & soft tissue infection, bone & joint infection & hospital acquired infection. MRSA is of two major types i.e. HA-MRSA & CA-MRSA. MRSA colonization increase the risk of infection and infecting strains match colonizing strains. MRSA infection is detected by Antimicrobial Susceptibility Test i.e. Disc Diffusion Test by using cefoxitin or oxacillin discs. MRSA isolates showed variable resistance to ciprofloxacin, erythromycin, clindamycin & tetracycline. MRSA contains a new gene encoding a protein (MecA) present in cell wall of MRSA. Antibiotics like penicillin & Methicillin do not bind to Mec A So they cannot kill the bacteria.

Keywords: *Staphylococcus*, HA-MRSA- Healthcare Associated – MRSA, CA-MRSA - Community Associated - MRSA.

ASSESSMENT OF GROUNDWATER QUALITY USING WATER QUALITY AND HEALTH RISK INDEX IN NCR REGION OF UTTAR PRADESH, INDIA

FAHEEM AHAMAD* MUKESH RUHELA AND SWETA BHARDWAJ
Swami Vivekanand Subharti University Meerut-250005, (UP), India

ABSTRACT

Groundwater quality and quantity both are important for the survival of human beings on this planet. In the present study an attempt has been made to assess the groundwater quality at mass using points. To fulfil the objectives of the present study, four sites (Sahibabad, Ghaziabad, Muradnagar, and Modinagar) were selected along the metro line construction from Delhi to Meerut. At all these sites, workers of metro line projects are living and working and using the groundwater for drinking purpose. Sampling was carried out from July 2021 to June 2022 using grab method of sampling. The samples were analysed for pH, total dissolved solids (TDS), total hardness (TH), calcium, magnesium, chloride, sulphate, nitrate, and fluoride. The data was processed using water quality index (WQI) and Pearson correlation matrix. TDS at all the study sites ranged from 514mg/l to 549.3mg/l and the values are above the standard limit of BIS (500mg/l). Values of TH, calcium and magnesium were found above the limits prescribed. Concentration of Chloride, nitrate, sulphate, and fluoride were found below the limits prescribed by BIS. However, nitrate is approaching to the standard limit (45mg/l). Correlation matrix shows that calcium is responsible for increasing values of TDS. As per the values of WQI, water quality of site 2 (46.7762), 3 (48.3523) and 4 (48.6281) falls in good category while at site 1 (50.9363) in poor category. Minimum HI (1.8380) was observed at SS-4 while maximum (2.6960) was observed at SS-3. The HI values at all the sites were found greater than 1 which indicates that consumption of the groundwater in the study area is not safe. The HI values also declare carcinogenic risk due to consumption of groundwater in the study area. Based on the present study, we can conclude that groundwater of the study area is not suitable for drinking purpose in the raw form but it requires treatment.

COSTS AND BENEFITS OF TWO OIL PALM PLANTATIONS LOCATED IN UGANDA AND MALAYSIA

Bonny Kayondo, Mohamadu Boyie Jalloh, Iimas Abdurofi, Nur Aainaa Binti Hasbullah, Paramanathan Selliah

Purpose

Oil palm is an adaptable crop grown in diverse tropical environments. However, its optimal productivity is constrained by prevalence of poor soils, weak agronomic practices and environmental constraints common in Africa. Therefore, to increase its productivity and efficiency in such areas requires extra costs to match yields obtained in ideal environments and well-managed commercial plantations found Malaysia. High yields reduce the cost of production, which is a key to compete in a commodity-based market. In this study, we aim to determine the economic feasibility of the two oil palm plantations.

Methods

Cost benefit analyses were used with the Input-Output Ratio measurement. Secondary oil palm fresh fruit bunch and crude palm oil production data from 2016 to 2021 from the two plantations was used. Total revenue, total variable costs and total fixed costs were computed using the CBR formula.

Results

Generally, the average CBR results of 1.70 show that the plantation investment in Uganda is 19% economically more rewarding than the plantation in Malaysia. However, in 2016 & 2017,

the lower CBR results for the plantation in Uganda compared to that in Malaysia was because of the low yields hence high crude palm oil product cost.

Conclusions

Cost benefit analysis results obtained from plantation in Africa imply that investment in soil fertility and water conservation increases oil palm production and land productivity. Policy makers in the oil palm sector should therefore consider expanding the commercial oil palm industry in Uganda.

Keywords: Costs, benefits, oil palm, soils, agronomic practices.

WATERSHED PRIORITIZATION OF KAILALI DISTRICT THROUGH MORPHOMETRIC PARAMETERS AND LANDUSE/LANDCOVER DATASETS USING GIS

SUSIL OJHA^{1*}, LILA PURI¹, ARJUN PRASAD BASTOLA¹

¹Institute of forestry Pokhara Campus, Tribhuvan University, Nepal

ABSTRACT

Watershed prioritization is considered an important tool for soil and watershed management. This study focuses on watershed prioritization of Kailali district in terms of soil erosion considering morphometric parameters and land use/landcover (LULC) datasets using GIS. ALOS DEM of 28.96 m resolution was used to delineate sub-watersheds and calculate linear, areal, and relief morphometric parameters. Similarly, Esri LULC 2021 (Sentinel-2 imagery at 10m resolution) was used to calculate LULC parameters. An integrated approach of Principal Component Analysis (PCA) and Weighted Sum Analysis (WSA) was used for prioritization. PCA was used to reduce selected parameters, calculate the correlation matrix, and define the significant parameters. WSA was used to define weightage value and Compound Value (CV) was calculated for ranking of sub-watersheds. 22 sub-watersheds with at least 3rd order stream and 15 parameters were selected for prioritization. PCA integrated with WSA was found to be effective for prioritization. The findings showed that about 61.58% of the watershed area is under the high-priority category suggesting those areas are at a higher risk of erosion. Therefore, different land rehabilitation programs and bioengineering techniques should be focused on the Sub-watershed of high-priority categories followed by medium and low priority categories to control further soil erosion. The adopted methodology of prioritization can also be performed for multi-hazard mapping.

Keywords: Compound Value, Principal Component Analysis, Soil Erosion, Weighted Sum Analysis

EFFECT OF DIFFERENT LAND USE SYSTEMS ON SOIL QUALITY UNDER SUBTROPICAL REGION OF JAMMU.

D.MAMTA*, K.R. SHARMA

Division of Soil Science & Agricultural Chemistry, Faculty of Agriculture Sher-e-Kashmir University of Agricultural Sciences & Technology of Jammu

ABSTRACT

Soil quality degradation is a major challenge in sub-tropical region of Jammu. This poses a great threat to soil quality of this particular area. Thus, a study was conducted to evaluate the effect of different land uses on physico-chemical, biological parameters and on soil quality. Geo-referenced soil samples were collected from five different land uses of subtropical region of Jammu and analyzed in the division of soil science and agricultural chemistry, FOA,

SKUAST-J, Chatha for different physical, chemical, and biological attributes. The results showed that the forest land resulted in reduced surface and sub-surface compaction, highest water holding capacity and saturated hydraulic conductivity and better aggregate stability and pore-size distribution as compared to agriculture land use and higher water retention in surface and sub-surface soil depths, was registered in grassland followed by forest, agroforestry, horticulture and lowest in agriculture. Available N and K were highest in the soil depths of forest and lowest in agriculture land use but available P was highest under agriculture land use and lowest under horticulture land use. Forest land use registered highest organic carbon content in the surface and sub-surface soil depths and lowest in agriculture. Labile carbon was found to be highest in forest and lowest in grassland system. Highest CEC was recorded in forest land and lowest in agriculture land. Forest soils were found to have the highest content of exchangeable Ca and Mg and it was least in the agriculture soils. In case of sodium the horticulture land use registered highest content in both the depths and forest recorded the least. DTPA extractable zinc was highest in forest and lowest in grassland. Horticulture land use registered greatest content of DTPA extractable iron and copper in the surface and sub-surface soil depths and lowest in grassland. Whereas DTPA extractable iron and lowest in grassland. Agriculture land use registered highest content of extractable manganese in the surface and sub-surface soil depths and lowest in grassland. Forest land use recorded highest soil DHA, SMBC, SMBN, alkaline phosphates and microbial population in the surface and sub-surface soil depths followed by grassland, horticulture, agroforestry and lowest in agriculture. The selected soil quality indicators from various land uses, namely DHA, macro aggregates, clay, and phosphorous, are most appropriate soil quality indicators. SQI as affected by different land uses was followed the trend Forest > Grassland > Agroforestry > Horticulture > Agriculture. The Forest land use obtained maximum SQI was at par with that in grassland but significantly higher than that in Agroforestry, Horticulture and Agriculture. Forest land use had 21.7 per cent higher SQI than that in agriculture

Keywords: Land uses, soil quality, soil quality index, subtropical

ROLE OF SUCROSE AND ITS METABOLISM IN SEED DEVELOPMENT

¹APARNA JYOTI, AMRITA KUMARI²

¹Department of Seed Science and Technology, CSKHPKV, Palampur-176062, Himachal Pradesh

²Department of Soil Science and Agricultural Chemistry, CSK Himachal Pradesh Krishi Vishvavidyalaya, Palampur – 176062

ABSTRACT

Sucrose is most abundant disaccharide and the major product of photosynthesis. Sucrose is the most common carbohydrate used to transport carbon within a plant. It is a non-reducing sugar with limited chemical reactivity and thus is utilized as a transport and storage molecule in most plants. Sucrose is used as source of energy, building blocks, signalling molecules for non-photosynthesizing organs of plants and also supports plant growth and metabolism. Sucrose synthesis is predominant in leaves, but the ability to synthesize sucrose is fairly widespread among plant cells. The translocation of synthesized sucrose from source to sink tissue is essential for proper plant growth and development. Sucrose can be translocated either simplistically or apoplasts with the help of sucrose transporter.

Sucrose involves two enzymes for its cleavage i.e., sucrose synthase and invertase. The sucrose degrading enzymes are required for seed development as well as enhancing other seed quality parameters like germination, vigour. The sucrose has three fates either it is used as source of energy, stored in form of starch or stored in vacuole if it is in excess.

Thus, it can be concluded from above studies that sucrose plays an important role in seed quality enhancement. By knowing the role of genes involved in sucrose transportation and its metabolism and their effect on seed quality, level of sucrose can be manipulated by using different biotechnological approaches which in turn will be helpful for improving germination, longevity, and vigour of seeds.

Keywords: Seed, Sucrose, Seed development,

ANALYSING FOREST MANAGEMENT PRACTICE THROUGH REGENERATION STATUS AND GROWTH PATTERN IN DIFFERENT FELLING SERIES: A CASE STUDY FROM COMMUNITY FOREST OF RUPANDEHI DISTRICT, NEPAL

BISHWABANDHU ACHARYA^{1*}, BIKASH ADHIKARI¹, ARJUN PRASAD BASTOLA¹, YAJNAMURTI KHANAL²

¹Institute of Forestry, Pokhara Campus, Tribhuvan University, Nepal

²REDD Implementation Centre, Babarmahal, Kathmandu

ABSTRACT

Forest regeneration means the renewal or development of new plant species in the forest area. Assessment of regeneration status in any forest is vital to understanding forest dynamics and developing management strategies. Scientific Forest management (SciFM) in community forestry emphasizes establishing and growing regeneration adopting different silvicultural systems. In order to assess the effectiveness of forest management practices, we examined the regeneration condition and its pattern in the forest with scientific forest management plan. Data relating to regeneration status and its growth pattern were collected from two community forest using stratified random sampling. The results depicted the good regeneration conditions (Seedling>5000, Sapling>2000) in all the felling series of both the forest. The number of seedlings and saplings were found highest in the sixth-year felling series (22,000 per ha) in Kanchan CF while it was highest in fifth year felling series (35,700 per ha) in case of Rajapani CF. The forest of both the CF was dominated by Sal (*Shorea robusta*) followed by Asna (*Terminalia alata*) and Karma (*Adina cordifolia*). The number of seedlings per hectare was found higher in the strata with latest regeneration felling while the number of poles per hectare is found higher in the strata with oldest regeneration felling in condition where there was less human pressure. The overall growth pattern of regeneration based on average diameter and average height of Kanchan CF showed an upward sloping curve with the increase in years after the regeneration felling while that of Rajapani CF showed a slightly irregular curve representing irregular growth of regeneration based on average height. There were altogether 14 and 13 species in Kanchan and Rajapani CF respectively where both CF showed similar degree of species richness and evenness. This research contributes to assess forest sustainability based on regeneration growth and develop appropriate management strategies. It recommends the implementation of SciFM with proper monitoring and continuous management practices enhances the forest health and growth.

Keywords: Growth pattern, Regeneration, Scientific Forest management, Silvicultural system, Sustainability

CYANOBACTERIA AS A BIOREACTOR FOR THE AGNPS SYNTHESIS AND THEIR APPLICATIONS

SHAHEEN HUSAIN

AINT Amity University Uttar Pradesh, Noida, 201303

ABSTRACT

The green synthesis of metallic nanoparticles has paved the way for improving and protecting the environment by decreasing the use of toxic chemicals and eliminating biological risks in biomedical applications. Biological synthesis of metal nanoparticles is gaining more importance due to simplicity, rapid rate of synthesis and eco-friendliness. Biosynthesis of silver nanoparticles (AgNPs) using cyanobacterial aqueous extract as the reducing and capping agent for AgNPs synthesis. The synthesized nanoparticles were characterized by UV-VIS spectrum, SEM, EDS, TEM, AFM, DLS and XRD. Obtained nanoparticles were polycrystalline in nature and synthesized AgNPs with surface plasmon significant band in the size range of 6-45nm with average 30 size nm. FT-IR study revealed the role of secondary metabolites present in aqueous extract for the synthesis of AgNPs. Biological activities of purified AgNPs as antioxidant and antibacterial potential showed the highest antibacterial activity against *Staphylococcus aureus* MTCC 902.

Keywords: Cyanobacteria, AgNPs, Biological synthesis, Antioxidant, Antibacterial

INTRODUCTION OF *HEENG* (*Ferula assa-foetida*) PLANT TO COLD DESERTS OF INDIAN HIMALAYAS

ASHOK KUMAR^{1*}, SANATSUJAT SINGH¹, SATBEER SINGH¹, RAMESH CHAUHAN¹, AND SANJAY KUMAR²

¹Agrotechnology Division, Council of Scientific and Industrial Research - Institute of Himalayan Bioresource Technology, Palampur - 176061 (Himachal Pradesh) India

² Director, Council of Scientific and Industrial Research - Institute of Himalayan Bioresource Technology, Palampur - 176061 (Himachal Pradesh) India

ABSTRACT

Heeng (*Ferula assa-foetida*) is one of the important spice and medicinal plants in India. *Ferula assa-foetida*, a native of Iran, Afghanistan and Uzbekistan, is a herbaceous perennial plant of the family Apiaceae. *Heeng* is used as a spice in household kitchens in India and other south Asian countries. India alone consumes approximately 40% of the world's *Heeng* produce and is 100% dependent on imports. India imports about 1542 tons of *Heeng* annually and spends about ₹950 crores on it. Recognizing the importance of *Heeng*, CSIR-Institute of Himalayan Bioresource Technology (CSIR-IHBT), Palampur introduced its seeds through ICAR-National Bureau of Plant Genetic Resources (ICAR-NBPGR), New Delhi. Seed germination of *Heeng* was standardized by overcoming the seed dormancy through various experiments. After standardization of germination, seedlings were raised in controlled conditions at CSIR-IHBT, Palampur. *Heeng* cultivation has been initiated at farmers' fields in five districts, i.e., Lahaul & Spiti, Kinnaur, Mandi, Kullu and Chamba of Himachal Pradesh, and other states and the Union Territory of India, i.e., Jammu & Kashmir, Ladakh and Uttarakhand, covering an area of 4.86 ha (32,000 *Heeng* plants). The country's first '*Heeng* Germplasm resource center' has also been established at the experimental farm of CSIR-IHBT, Palampur. To the best of our knowledge, it is the first attempt to domesticate the *Heeng* plant in India. Cultivation of *Heeng* will also help improve farmers' economic status in cold desert regions. The production of *Heeng* in the region will help its local availability at a cheaper cost.

Keywords: Domestication; *Ferula assa-foetida*; *Heeng*; Indian Himalayas; Introduction; Spice

ASSESSMENT OF IMPACT OF POVERTY ON CHURE DEPLETION

BIPIN YADAV, DHRUVA BIJAY GC AND JIT NARAYAN SHAH

Purpose

This case study analyses dependency of local community on chure forest for major forest products and also analyses impacts of poverty on chure degradation in Fulbariya region of Mirchaiya municipality, Siraha. It also describes local community’s knowledge, perception and practice of chure forest. Poor community living adjacent to chure forest are highly dependent on forest resources from chure, however it is known that level of dependency of local people on chure forest will not be the same for all. Hence this study entitled “Assessment of Impact of Poverty on Chure Depletion” (A case study from Siraha District) assesses chure forest resource use pattern and its impacts by the influence of various socio-economic variables of respondents.

Method

Primary data collection method included semi-structured questionnaires for 65 Households, 5 Focus Group Discussions and 15 Key Informant Interviews followed by direct field observation and frequent field visits. The secondary data were collected from reports available at Division Forest Office, Siraha, office of Mirchaiya Municipality, operational plan of Ram Krishna Community Forest, Information available at Rashtrapati Chure Terai Madhesh Conservation Board and Institute of Forestry, Pokhara. Primarily, this research is based on descriptive statistics. Microsoft- Excel and R were used to analyze collected data, where analysis is illustrated by column, line, area, bar diagram and 3-D pie-chart. Spearman’s Rank Correlation was used to determine the dependency of various socioeconomic variables on forest products collections. Forest products collection was found correlated negatively significant with net annual income.

While discussing with local, we came to know that among timber, fuelwood and fodder, Fodder followed by fuelwood were highly collected. Timber collection was found rare. The daily average forest products collection was highest among madheshi dalit who had collected 75 loads of fodder and 44 loads of fuelwood from chure, where the least was among aadiwasi group who collected only 4 loads of fodder and 2 loads of fuelwood on daily average. Average daily collection was also highest among poor, who collected an average of 130 loads of fodder and 78 loads of fuelwood, where rich did not collect any forest products from chure. One way ANOVA was used to test if there is significant difference between forest products collection with wealth rank and ethnicities. For both tests, null hypothesis was rejected and alternate hypothesis was accepted implying there is significant differences.

Result

The serious issue recognized was exploitation of chure forest to meet subsistence need of forest products by landless poor community, that has led to heavy deforestation, open grazing, encroachment of bighas of chure forest, agricultural expansion and human settlement expansion. Chure depletion in Fulbariya has resulted in shortage of forest products such as timber, fuelwood and fodder for livestock, increased human wildlife conflicts, water resources depletion, land degradation and loss of biodiversity.

Keywords: Chure, Depletion, Socio-economic, Descriptive, Microsoft- Excel, Encroachment, Degradation, Biodiversity and Sensitization

RESOURCE ASSESSMENT AND MARKETING OF CATERPILLAR FUNGUS (*OPHIOCORDYCEPS SINENSIS*) IN THE BUFFER ZONE OF MAKALU BARUN NATIONAL PARK, NEPAL

DAMODAR GAIRE^{1*}, KAMAL KAFLE² JIT NARAYAN SAH³

¹Tribhuvan University, Institute of Forestry, Hetauda Campus, Nepal,

²Chitwan National Park, Nepal

³Tribhuvan University, Institute of Forestry, Pokhara Campus, Pokhara, Nepal

ABSTRACT

Yarsagumba (*Ophiocordyceps sinensis*) is one of the highly expensive and potential medicinal mushrooms in the world. Owing to the herb's high efficacy and potency in curing various diseases, it is well known as an important nourishing tonic. The study has attempted to gather information regarding Yarsagumba, its associated species, various medicinal uses, and marketing channel. Out of 15 plots, only 3 plots were recorded the Yarsagumba with a frequency of 0.2 which was very low compared to other medicinal plants. We randomly recorded the Yarsagumba with a density of 833 (No)/ha equal to 0.5 kg/ha in the effective area. There was an imbalance between the population of moths and the spores of Caterpillar fungus. There were increasing trends in *Cordyceps sinensis* market, heavily dependent on Chinese buyers. The Chinese companies send agents to collect Yarsagumba directly from the fields. And they pay US\$ 10/piece to villagers (according to the latest field study, June 2019). China is the largest producer of Yarsagumba and meets 95 percent of the world's demand. Nepal is the second largest supplier of fungus. Expansion of marketing channel is essential for getting more benefits focusing on local Yarsagumba collectors. It was observed that only 14.51 percent of men participated to collect the Yarsagumba because the majority of men migrated to India and overseas for searching jobs. Therefore, women would play a vital role in the sustainable harvesting of Yarsagumba. Different pharmacological actions such as antiasthma, antineoplastic, and antibacterial as well as actions on the heart and blood vessels, and on the smooth muscles of the intestine and uterus have been reported. The government of Nepal should prepare a national Yarsagumba management policy and local Yarsagumba management guidelines to address conflicts by clearly defining the roles, responsibilities, and rights of local institutions and actors. The Makalu Barun National Park should also prepare a separate management plan for sustainable harvesting so that local people would enhance their income, and the government would also increase income through royalties.

Keywords: Yarsagumba; Production; Collection; Sustainable Harvesting; Marketing, Policy

HABITAT AND ANTHROPOGENIC FACTORS INFLUENCING GHARIAL (*Gavialis gangeticus*) DISTRIBUTION AND HABITAT USE IN NARAYANI RIVER OF CHITWAN NATIONAL PARK, NEPAL

CHITRA REKHA BASYAL, BIJAYA NEUPANE, JIT NARAYAN SHAH

Purpose

The gharial (*Gavialis gangeticus*) is critically endangered freshwater fauna. Yet, information on its habitat characteristics and impact of anthropogenic threats on its existence is limited in Nepal. Thus, this study assessed habitat and anthropogenic factors associated with gharial occurrence in the Narayani River. Further, the Knowledge, Attitude, and Practice (KAP) of river-dependent communities towards gharial conservation was also examined.

Methods

The 50 km segment of the Narayani River was taken as an intensive study area and habitat characteristics were recorded at stations spaced at 500m intervals along the river and wherever gharials were sighted. A total of 155 respondents living within 1 km of river bank were interviewed for the KAP survey. Habitat factors influencing the probability of detection of gharial were analyzed using binomial logistic regression using R software whereas SPSS was used to analyze the KAP scores.

Results

A total of 33 gharials were detected with an encounter rate of 0.6 gharial per km. Among the 12 habitat variables examined, only four habitat variables, air temperature, mid river depth, cloudy and sunny weather exhibited significant differences in the probability of gharial sightings, and other eight habitat factors like river bank orientation, river width, river bank substrate type, topography, river bank slope, invasive species, water temperature, availability of basking site and altitude did not have significant differences. The majority of the gharials were detected at 2 m to 3 m of water depth, 25- 30°C of air temperature, 19 °C of water temperature and 200 - 300 m of river width. Further, in sandy river bank, flat river topography of 0-10°, river bank slope of 0-30°, locations with no invasive species and no observed anthropogenic threats majority of gharials were observed. Gillnet fishing, pollution, and human disturbances were recorded as the major anthropogenic threats to gharial. The KAP analysis showed that moderate knowledge (65.25%), positive attitude (72.16 %), and safe practice (53.45%) and significant correlation between the KAP scores.

Conclusion

This study recommends for the preservation of river confluences, sand bank management and effective enforcement on the use of gillnet for gharial conservation in Narayani River.

Keywords: Attitude, Knowledge, Practice, Temperature, Water depth

INNOVATION OF SPOT APPLICATOR IN PINEAPPLE CROP FOR UNIFORM HARVESTING

MR. RAJEEV P. NADIG^{*}, DR. ARUNKUMAR P.^{}, DR. SHASHIDHAR K. C.^{**}, DR. PREMASUDHA B G.^{***}**

***Prabhat tek nova, Shivamogga – Karnataka – India - 577201,**

****Keladi Shivappa Nayaka University of Agricultural and Horticultural Sciences (KSNUAHS), Shivamogga – Karnataka – India – 577201,**

*****Siddaganga Institute of Technology (SIT), Tumkur - Karnataka – India – 572103**

PURPOSE :

Technology developed by KSNUAHS, Shivamogga and PRABHAT TEK NOVA had MOU with KSNUAHS for production and commercialization for this tool. This tool delivers the measured liquid flow through the nozzle at one trigger and controlled by micro controllers and fits inside a 12 V battery operated backpack sprayer. In automatic made tool provides time setting, delay setting and volume setting for uniform harvesting in pineapple crop. Intelligent tool to deliver volumetric dispatch at once to the point of application, easy to use, reduce drudgery, less labor requirements, eliminated Health related chemical handing problems.

METHODS :

For uniform maturity of fruits & one stoke harvesting, 50ml ethrel is used on each plants crown @ 12-month days after planting. Otherwise harvesting period will extend up to 90 days in traditional method of cultivation. Volumetric dispatch at once to the point of application. Point the nozzle on the crown of the plant and press trigger exactly 50ml liquid will be delivered to the crown.

RESULT :

Labor required for application in 1 ha with medium density planting in pineapple crop required 2 man-days in SPOT APPLICATOR whereas 10 man-days in manual method. After the application of ethrel with SPOT APPLICATOR harvesting period is within 10 days where as in traditional method of cultivation it takes 90 days after the 12 months days after planting. Precise delivery to the exact point. It reduces drudgery and injury to the labor. Eliminated health related chemical handling problems. Easy to use with safety compare to traditional method of application.

CONCLUSION:

Creates safe working environment in agriculture, work effortless in the field, reduces drudgery of men and women labors in pineapple field, safety in handling chemicals, save time and money to the farmers, reduces unnecessary dumping of chemical to environment, reduces environment pollution.

Keywords: Spot applicator, uniform harvesting, volumetric dispatch, point of application.

MASS CLONAL PROPAGATION OF *MUCUNA PRURIENS* (FABACEAE) AND ASSESSMENT OF ITS PHYTOCHEMICAL PROPERTIES.

NEHA SAINI, NAVEEN GAURAV

Department of Biotechnology, Shri Guru Ram Rai Univesity, Patel Nagar, Dehradun,248001, Uttarakhand, India [NS, NG].

ABSTRACT

Mucuna pruriens, an essential remedial plant growing in the bushes, hedges and dry deciduous forests throughout India. It is thoroughly used in traditional homoeopathic medicine system of India for the treatment of male virility and neurological diseases. It is documented that *M. pruriens* comprises L-3,4-dihydroxy phenylalanine (L-DOPA) a neurotransmitter precursor, used for the cure of Parkinsons disease. Although all plant parts such as leaf, stem, seed and root of *Mucuna* have been promulgating to possess medicinal properties and these properties has been evaluated in various contexts, comprising for its aphrodisiac, anti-epileptic, antivenom, anti-diabetic, anti-neoplastic and anti-microbial activities. Apart from its medicinal properties, in many parts of the world, *M. pruriens* is utilized as an essential fodder, untilld and green compost crop in world scenario. These plants are additionally utilized as a very successful green fertilizer to add up to the fundamental issues of soils or as a cover crop as bioherbicide to preserve the environmental services of soil. Traditional techniques of propagation of this plant are restricted to seeds therefore germination rate and viability of seeds are very poor and also constitute problems because of allergic characteristics that give rise uncurbed itching, the contemporary methods of asexual propagation are Micropropagation that has manifest to be advantageous for in vitro propagation for *Mucuna pruriens* for commercial utilization of valuable plant-derived drugs. Seeds restrain a wide range of phytochemical elements such as alkaloids, glycosides, saponins, reducing sugars, and tannins, which lay out a path to explore it for its wider applications. In this review process of micropropagation and phytochemical properties and environmental preserverce properties of *M. pruriens* are summarized.

Keywords: *Mucuna pruriens*, Aphrodisiac, Parkinsons disease, Anti-epileptic, antineoplastic, bioherbicide, antivenom, etc.

NUTRITIONAL ASSESSMENT OF FRESH AND FERMENTED BAMBOO SHOOTS LOCALLY CONSUMED IN SIKKIM

L. BASANTARANI¹ & Y. RANJANA DEVI^{2*}

¹College of Agricultural Engineering & Post Harvest Technology, Ranipool, Sikkim

^{2*}Central Agricultural University, Lamphelpat, Imphal, Manipur

ABSTRACT

Bamboo, the giant arborescent grass of sub family *Bambusoideae* (family- *Poaceae*) is one of the most important forest resources of Sikkim. In Sikkim, there are more than 26 indigenous species of bamboo covering 10 genera which constitutes over 50% of bamboo species found in north eastern region. Though popularly known for industrial usage, a lesser-known fact of bamboos is the utilization of its juvenile shoots as food that can be consumed fresh, fermented, canned or pickled. Consumption of bamboo shoots is mainly concentrated in Southeast Asia, where they are a popular ingredient in the local cuisine. In India consumption of tender shoots and its fermented forms is confined mainly to the North Eastern states of India where they are part of the traditional cuisine. In Sikkim young tender edible bamboo shoot locally known as *tama* is used in preparation of unique and classic sikkimese curry which is a very popular food item amongst the ethnic people residing in Sikkim. Fermented bamboo shoot locally called as *mesu* which is as popular as *tama* is mostly eaten as a pickle and also as curry. The research work was undertaken to determine the nutritional content of *tama* and *mesu* to assess which form of the bamboo shoot is nutritionally richer and better for health. It was observed that both fresh and fermented bamboo shoots are rich in nutrient components, mainly proteins, carbohydrates and minerals and is low in fat. However, fermentation process leads to the depletion of nutrient components as compared to fresh shoots. Higher fibre content was observed in fermented shoot as compared with fresh shoot. Comparatively the fresh shoots are found to be nutritionally richer and better for health than the fermented shoots. Bamboo shoots with their high nutritive value, bioactive compounds, different medicinal properties and their easy availability to common man may help in solving nutritional deficiency of rural poor. It holds great promise for utilization as health food.

SEED PRODUCTION IN ANNUAL FLOWER CROPS

RAHAT ASHRAF¹ AND MEHJABEEN^{2*}

¹SCHOOL OF AGRICULTURAL SCIENCES AND TECHNOLOGY, RIMT UNIVERSITY, PUNJAB

²DEPARTMENT OF ECONOMICS, PERIYAR UNIVERSITY, SALEM

ABSTRACT

Seeds are perfect natural packages that facilitate plant species' migration across land and sea. In commercial floriculture, flower seed production is the most profitable and remunerative enterprise. About 800 ha of the area is under flower seed production in India. From Ludhiana, Bangalore and Kalimpong are the three main centers where 80-90% of seed production comes. India has great potential and scope for flower seed production with its diverse agro-climatic conditions, inexpensive human resources and other materials. The factors affecting flower seed production are environmental conditions, time of planting, planting density, nutrition requirement, PGR, pollination requirement, land requirement, isolation distance, field inspection, weed control, seed source and selection of variety, time and method of harvesting and post-harvest handling. In most flower crops, the seed yield is mainly dependent on the number of flowers bearing branches, which can be manipulated by checking the vertical growth

of plants. Growth regulators and nutrients are used to overcome limiting growth and yield to harness maximum benefit from seed production. It is also observed that foliar application of growth regulators and nutrients stimulates flowering, pollination, fertilization, and seed set to get maximum seed yield. Quality seeds of commercial value can be produced by adopting advanced agronomic practices specific to the crop. Productivity can also be increased by exploiting genetic male sterility and self-incompatibility. The two best methods for hybrid seed production utilizing somatic embryogenesis, which is cost-effective and time-saving, also seem to have great potential in future. Using advanced seed enhancement practices to improve germination and seedling vigor to obtain disease-free and quality products of commercial value should be encouraged to bring profit and Improved harvesting. Post-harvest management practices should be well planned.

Keywords: Seed, flower production, Post-harvest Management

SUSTAINABLE UTILISATION OF NATURAL RESOURCES: PROBLEMS AND SOLUTION

MADHU SHARAN

**Department of Clothing and Textiles, Faculty of Family and Community Sciences
The Maharaja Sayajirao University of Baroda, Vadodara, Gujarat, INDIA**

ABSTRACT

Depletion of natural resources is a big question in the present context across the world. Do able solution is required to minimize the use of natural resources without affecting the human life. Problem underlying this is that natural resource management cannot be taken in isolation, it is always based on more than one factor. It should consider human health, laws and regulations, politics, availability of resources, factual basis and costs. This paper deals with the workable solution for the sustainable use of natural resources keeping in mind all the factors involved. Sustainable here has been taken as the method of utilization of natural resources which can be continued over a period of time and are easy to be adopted. Waste from the agriculture were explored for its utilization, thus reducing waste and producing useful products simultaneously.

Keywords: sustainable, resource, depletion, solution

EFFECT OF IRRIGATION AND FERTIGATION LEVELS MULCH ON GROWTH, YIELD AND QUALITY OF CAPSICUM (*Capsicum annum* L.) UNDER POLY HOUSE

SUNIL KUMAR YADAV *, RAJA RAM BUNKER **

*** Department of Horticulture, SKNCOA, SKNAU-Jobner Rajasthan**

****Department of Horticulture, RCA, MPUAT, Udaipur, Rajasthan**

ABSTRACT

A field experiment was conducted at Hi-tech Nursery field, located at Main Campus, Swami Keshwanand Rajasthan Agricultural University, Bikaner to study the effect of irrigation levels and mulch on growth, yield and quality of cucumber under poly house, during *Rabi* 2017-18. The experiment was laid out in split plot design with four replications. The treatment comprised of three drip irrigation levels at 0.4, 0.6, 0.8 and 1.0 ETC assigned in main plot and three fertigation levels viz; 75%NPK,100%NPK and 125%NPK assigned in sub-plot.

Research results indicated significant variation in all the vegetative growth attributes, yield and quality parameters in different drip irrigation and fertigation levels. The maximum number of branches per plant, length of plant, number of leaves per plant and leaf area were recorded with 1.0 ETC as compared to other drip irrigation treatments at 60, 90 DAT and harvest. However,

in respect to earliness *i.e.* days to first flowering, fruiting and harvesting were also observed with the treatment 1.0 ETc. The maximum fruit length (13.04 cm), fruit girth (3.67 cm), average fruit weight (110.52 g), number of fruits per plant (12.99), fruit yield per plant (1.39 kg), total fruit yield (567.03 q ha⁻¹) and net return (Rs. 114995 ha⁻¹) with 3.16 B:C ratio were recorded under 1.0 ETc of drip irrigation treatment. Further, 0.8 ETc gave at par values for all these parameters with 1.0 ETc. However, water use efficiency (13.13q ha⁻¹ mm⁻¹) was found maximum with 0.8 ETc. The results also revealed that quality parameters like chlorophyll content (60 DAT) were found maximum with the treatment 0.6 ETc and 1.0 ETc, respectively, whereas, drip irrigation levels did not influence moisture content in fruit.

Keywords: Drip irrigation levels, fertigation levels etc.

EFFECT OF GIBBERELIC ACID IN CUCUMBER

KAMLESH KUMAR YADAV¹, SUNIL KUMAR YADAV¹ AND GANPAT LAL YADAV¹

¹Department of Horticulture, S.K.N. College of Agriculture, Jobner, Rajasthan-303328

ABSTRACT

Cucumber (*Cucumis sativus* L; 2n = 2x = 14), is one of the most economically important members of the family Cucurbitaceae. Basically, the fruits are extremely nutritive and folk medicine for many diseases. Also, cucumber has been used as skin protector. Cucumber have trimonoecious flowering habit which produces gynoecious, predominantly gynoecious and monoecious flower. Gibberellic acid (GA) is a tetracyclic di-terpenoid compound, a plant hormone that stimulate plant growth and development. GAs stimulates seed germination, trigger transitions from meristem to shoot growth, juvenile to adult leaf stage, vegetative to flowering, determines sex expression and fruit development along with an interaction of different environmental factors *viz.*, light, temperature and water. The major site of bioactive GA is stamens that influence male flower production and pedicel growth. GA can regulate sex expression of cucumber via GA₃ application markedly induced male flowers but decreased ethylene production in shoot tips. The evaluate potential of seed pre-soaking in different concentrations of gibberellins (0, 5µg/ml, 10µg/ml and 20µg/ml) on cucumber growth, flowering, and yield. Application of 10 µg/ml GA₃ was established to the majority appropriate for improving growth, flowering performance, and fruit yield.

Keywords: Cucumber, Gynoecious, Gibberellic Acid, Sex expression etc.

EFFECT OF DIFFERENT DRYING CONDITION ON THE COLOR AND REHYDRATION CHARACTERISTIC OF ASPARAGUS (*Asparagus Racemosus* L.) ROOTS

DEEPIKA KOHLI

Department of Processing and Food Engineering, College of Technology and Engineering, Maharana Pratap University of Agriculture and Technology, Udaipur, Rajasthan-313001

ABSTRACT

Drying is used in food processing industry to provide microbiological stability, reduce the product deterioration due to chemical reactions, facilitate storage, and also lower transportation costs. The selection of a suitable drying technology is a challenging task because fruits and vegetables are susceptible to heat. In the present study, fresh asparagus roots were pre-treated in hot water at 80°C for 5 min. The methods of drying used for study was tray drying,

microwave drying, infrared drying and heat pump drying. Experiments were conducted to study the effect of drying conditions on color and rehydration characteristics. Total drying time decreases with increase in drying air temperature from 45°C – 65°C. The whole drying took place in falling rate period only. It can be concluded that the product quality in terms of rehydration characteristics and colour was found to be most acceptable when asparagus roots were dried in infrared dryer.

Keywords: Drying, Asparagus, food quality, food processing, food preservation.

PRINCIPAL COMPONENT ANALYSIS IS AN EFFICIENT TOOL FOR HIGHLIGHTING THE RELATIONSHIPS WITH IN YIELD AND YIELD ATTRIBUTES OF GREENGRAM [*Vigna radiata* (L.) Wilczek]

SHAILENDRA SAGAR PRAJAPATI¹, SANJAY KUMAR SINGH¹, PRATIK KUMAR¹, PARIKHA PRAKASH SINGH², KARISHMA BEHERA¹ AND KRISHNAKANT VISHWAKARMA³

¹Department of Genetics and Plant Breeding, College of agriculture, JNKVV, Jabalpur, MP, 482004

² Department of Plant Physiology, College of agriculture, JNKVV, Jabalpur, MP, 482004

³Department of Molecular Biology and Biotechnology, College of agriculture, JNKVV, Jabalpur, MP, 482004

ABSTRACT

A total of 39 genotypes of mungbean were taken for analysis in the present study for statistical analysis related quantitative traits. To investigate the Principal component analysis (PCA) is an analysis technique used primarily to display patterns in multivariate data among these mungbean genotypes using quantitative traits. The present study was carried out at the BSP Soybean unit, College of Agriculture, JNKVV, Jabalpur, and Madhya Pradesh. The genotypes were sown in six rows of with 30 X 10 cm spacing under RCBD design with three replications. The seed sowing was made in the month of November. The statistical methods and parameters used for deriving inference were to Principal Component Analysis (Massy, 1965 and Jolliffe, 1986). It aims to display the relative positions of data points in fewer dimensions while retaining as much information as possible. PCA assumes that the relationships between dependent variables are linear. Large datasets are more prevalent than ever and are frequently challenging to comprehend. A method for lowering the dimensionality of such datasets, improving interpretability while minimising information loss, is principal component analysis (PCA). It accomplishes this by producing fresh, uncorrelated variables that maximise variance one after the other. As a result, PCA is an adaptive data analysis technique. Finding these new variables, the Principal components, simplifies to solving an Eigen value/ Eigen vector issue, and the new variables are specified by the dataset at hand, not a priori. It is also adaptable in the sense that numerous variations of the technique have been created to fit different data formats and types. This essay will begin by outlining the fundamental concepts of PCA and outlining what it can and cannot accomplish. Based on the results of PCA, promising lines Identified are: TJM 124, TJM 134 and Pusa Vishal for yield and resistance. Genotypes TJM 141, TJM 145 and TJM 134 contributed maximum PC scores in different PC components. These identified genotypes should be utilized for crop improvement programme for yield improvement traits.

Keyword: Mungbean, Principal component analysis, PC Score

COMPARATIVE STUDY OF CARBON STOCK IN COMMUNITY FORESTS OF CHURE AND MAHABHARAT RANGE IN SINDHULI DISTRICT, NEPAL

Sushma Poudel*, Keshav Raj Acharya, Dhiraj Bhatta, and Srijana Khanal

Purpose

Community forests have been critical in halting deforestation and mitigating climate change in Nepal's vulnerable Chure and Mahabharat ranges, but carbon assessments in these ranges have yet to be quantified, necessitating the current study.

Method

14 circular sample plots with a sampling intensity of 0.5% were laid out systematically in each community forest. For a tree, pole, sapling, leaf litter, herbs, and grasses (LHGs), sample plots of 500 m², 100 m², 25 m², and 1 m² were established, respectively. Additional soil samples were collected from each plot at depths of 0-10 cm, 10-20 cm, and 20-30 cm. The biomass of trees, poles, and LHGs was calculated directly in the field and multiplied by 0.47 to convert to carbon. The Walkley-Black method was used to determine soil carbon. The data was compiled and analyzed using Microsoft Excel and R.

Results

Carbon stock in the Mahabharat Chyandada community forest was 166.53 t/ha, with 57.29% in soil, 33.80% in above-ground biomass, 8.71% in below-ground biomass, and 0.20% in leaf litter, herbs, and grasses biomass, and 169.66 t/ha in Chure's Pashupati community forest, with 55.61% in above-ground biomass, 33.21% in soil, 11.12% in below-ground biomass, and There was no significant difference in tree carbon stock between the two ranges when the two independent samples T-test was used. Total pole carbon stock, total sapling carbon stock, total leaf litter, herbs, and grasses carbon stock, and soil carbon stock differed significantly between the two ranges. Soil carbon levels were found to decrease as soil depth increased.

Conclusions

The difference in carbon stock between the two ranges was due to the different carbon sequestration potential of different species and also the ability of carbon sequestration varies according to the site, time, and management intervention applied. This study shows that community forests have great potential for storing atmospheric carbon, thereby reducing emissions.

Keywords: Biomass- carbon sequestration- chure- community forest- Mahabharat- soil carbon

PHYSIOLOGICAL APPROACHES FOR YIELD MAXIMIZATION IN RICE (*Oryza sativa* L.)

YASMEEN BEGUM¹, R. P. PATIL² AND K. MAHANTHASHIVAYOGAYYA³

¹Department of Crop Physiology, University of Agricultural Sciences, Raichur, Karnataka, India 584 104

²Department of Crop Physiology, University of Agricultural Sciences, Raichur, College of Agriculture, Bheemarayana Gudi- 585 287

³ARS, Gangavathi, University of Agricultural Sciences, Raichur

ABSTRACT

A field experiment was conducted at Agricultural Research Station, Gangavathi, UAS, Raichur, Karnataka, during *kharif* 2017 to study the effect of different agrochemicals in rice variety GNV-10-89. The experiment was laid out in randomized complete block design with 3 replications and 10 treatments along with control *i.e.*, T₁: 25 % extra nitrogen (N) soil application, T₂: NPK (19:19:19) @ 1 %, T₃: triacontanol (2 mL/L), T₄: GA₃ (50 ppm), T₅:

nitrobenzene (20 ppm), T₆: salicylic acid (500 ppm), T₇: 6-BAP (20 ppm), T₈: borax (0.2 %), T₉: T₃ + T₈ foliar applications and T₁₀: control. This variety showed chaffyness problem of about 35 per cent therefore, foliar and soil application of different agrochemicals at 65 and 85 days after transplanting (DAT) was done to improve morphological, physiological, biochemical, yield and yield attributing parameters. The results obtained at 95 DAT indicated that among different treatment, T₂ (NPK- 19:19:19 @ 1.0 %) recorded the significantly greater results as compared to other treatments as follows: morphological parameters *viz.*, number of green leaves (69.8), least number of senescent leaves (7.7) and higher number of productive tillers per hill (17.4) except plant height whereas, the highest plant height (98.2 cm) was recorded in T₄ (GA₃- 50 ppm) over rest of the treatment. The highest grain yield (8709.8 kg ha⁻¹) and less per cent of chaffyness (20.9 %) were recorded in T₂ (NPK- 19:19:19 @ 1.0 %) than other treatment. It was concluded that among foliar and soil application of agrochemicals T₂ (NPK- 19:19:19 @ 1.0 %) was found to be the best treatment and most ideal and economically feasible at 65 DAT and at 85 DAT. It was increased 22.9 per cent higher yield over control.

IMPACT OF CLIMATE CHANGE ON FISHERIES AND AQUACULTURE IN NEPAL

DILIP KUMAR JHA,

**Department of Aquaculture, Faculty of Animal Science, Veterinary Science and Fisheries
Agriculture and Forestry University, Rampur, Chitwan, Nepal**

ABSTRACT

Climate change is a replacement or an alteration in the normal weather pattern occurring over prolonged period of time affecting the whole world or only an specific region. Earlier evidence suggests that the global climate is now changing as a result of human activities. The rising of global temperature is going on and patterns of precipitation have also changed: arid and semiarid regions are becoming drier, while other areas, especially mid-to-high latitudes, are becoming wetter. In an aquatic system climate change is affecting the biological processes and the productivity of fish species. The consequences for sustainability of fisheries and aquaculture and the people that depend on them, are uncertain. It is now generally accepted that warming of the climate system is unequivocal, as evidenced from global increases in: average air and ocean temperatures; melting of snow and ice; and average sea levels. Unavailability of the proper amount of water may create problems in the near future. The fluctuation of minimum downstream release is found as the major cause for declining fish diversity. More anthropogenic disturbances and project structures are found creating impact on extinction of several protected species.

Nepal, a landlocked mountainous country is blessed with a number of watersheds in the form of rivers, streams, lakes, reservoirs, ponds, marginal swamps, low land irrigated paddy fields, irrigation canal and highway side ditches which covers an area of more than 828171 ha. The watersheds with different altitudinal variations from 60m-8848m represents a total of 252 fish species. Among them 236 species are indigenous while 16 species are exotic. These species belong to 15 orders, 40 families and 120 genera. Carps of the order Cypriniformes are the major fishes cultivated in Nepal. These includes Indian Major Carps; Rohu (*Labeo rohita*), Mrigal (*Cirrhina mrigala*), and Chinese Major carps; Grass carp (*Ctenopharyngodon idella*), Silver carp (*Hypophthalmichthys molitrix*) and Bighead carp (*Hypophthalmichthys nobilis*). Two varieties of Common carp; Scale carp (*Cyprinus carpio var. communis*) and Mirror carp (*Cyprinus carpio var. specularis*) are cultivated also. The exotic catfish, Pangas (*Pangasianodon hypophthalmichthys*) and Nile Tilapia (*Oreochromis niloticus*) are cultivating to some extent. Though the African catfish (*Clarias gariepinus*) is restricted for farming but it

is found in some farmers ponds also. The exotic coldwater Rainbow trout (*Oncorhynchus mykiss*) is growing in the hilly regions of Nepal. These indigenous and exotic fishes are important in several respects. Aquaculture has emerged as one of the fastest growing food production sub-sectors under agriculture and has great potential for future expansion. Inland capture fisheries and aquaculture are supported by the diverse agro ecological zones providing suitable habitat for different fish species which contributed 4.22% and 1.59% of the agriculture GDP and National GDP respectively. Annual fish production of Nepal is 104623 metric tons with the contribution of 83623 metric tons from aquaculture and 21000 metric tons from the inland capture fisheries, indicating per capita fish production 3.43 kg only. Nepal’s capture fisheries are stable while aquaculture is currently moving toward a sustainable development pattern with small input and major output. Aquaculture diversification and commercialization have drawn attention of the planner and policy makers in terms of generating more income, employment opportunities, and biodiversity conservation. The farming of high value low volume fishes and optimum utilization of available resources for production, processing and marketing operation has been conceived for the sustainable development of nation.

National Adaptation Program of Action to climate change indicates that Nepal is highly vulnerable to climate change and variability. Many natural disasters like floods, extreme temperature, erratic rainfalls, droughts, and erosion are causes due to the climate change. Climate change worsen the situation of small-holder fish farming households through total stock loss, increased mortality, reduced fish yield, damage to rearing units, increase operating cost, and also affect their livelihoods. Climate change impacts, if any, are likely to produce more significant net effects on the aquaculture sub sector in subtropical Terai regions than elsewhere because production is more concentrated there. The general effects of climate change on freshwater systems likely increased water temperatures decreased dissolved oxygen levels, and the increased toxicity. In lentic systems, eutrophication may be exacerbated and stratification becomes more pronounced and stronger. This could alter food webs and change habitat availability and quality. Fish growers faced many challenges and consequences in aquaculture during drought periods. The lack of adequate precipitation can cause reduced soil moisture, diminished stream flow, crop damage, and a general water shortage in the fish rearing unit. Climate change is an additional pressure on the freshwater aquaculture and the impacts of climate change on freshwater aquaculture are more complex than those on terrestrial agriculture because fish is poikilothermic animal which is highly sensitive to various kind of biotic and abiotic stress that directly affect the growth, reproduction, physiology and behaviour of fishes. Abrupt changes in the raining pattern effected the production of fishes during summer. Generally, this is the high time for the growth of fishes. Some of the farmers adopted many local practices to cope with drought and flood impact on aquaculture. In near future global hydroelectric capacity is going to be doubled and dam blocking of rivers degrading water quality, disturbance of aquatic and riparian habitat, migratory fish route blockage, economic impacts on fishery, and displacement of local communities. There is a need for a collaborative approach among different nations to cope with climate-related disasters.

A STUDY ON AGRICULTURE PRODUCTION IN INDIA

V. GANGADEVI AND A. SARAVANADURAI

Department of Economics, Periyar University, Salem-11.

ABSTRACT

The agriculture sector is the mainstay of the Indian economy, contributing about 15 per cent of the Gross Domestic Product (GDP). More importantly, nearly half of India's population is wholly or significantly dependent on agriculture and allied activities for their livelihood. In 1970-71 agriculture contributed about 44 per cent of GDP, which is declining nowadays. The total foodgrain production in the country stood at 251.1 MT in 2014–15, showing a decline of 13.9 MT from 2013–14. The soybean was taken in first place for the production of the oilseeds, whereas overall oil seeds production had decreased during 2014-2015 compared to the earlier year production in our nation. Cotton and jute production decreased during 2014-2015 with the reach of the previous year's output. But sugarcane production increased by 44.19 tonnes in 2014-2015 compared with 2013-2014. This study took the secondary data from the Directorate of Economics and Statistics, EPW Research Foundation, Handbook of Statistics on the Indian Economy, Central Statistical Office, and Various Journals and Publications. The objective of this study was agriculture production in India.

Keywords: Food Security, Policy Implications, Agriculture, Green Revolution and Uncertain Rainfall.

ESTIMATION OF MAIZE-SOYBEAN INTERCROPPING ON RUNOFF, SOIL AND NUTRIENT LOSS, AND CROP GROWTH UNDER FIELD CONDITION AT DIFFERENT SLOPES FOR SHIVALIK FOOTHILLS IN HIMALAYAS

RAM KUMAR, P. V. SINGH AND GURVINDER SINGH

Department of Soil and Water Conservation, College of Technology, Govind Ballabh Pant University of Agriculture and Technology, Pantnagar (Uttarakhand) India 263145

ABSTRACT

Supporting sustainable crop production on hilly, sloppy, and erodible soils in the Himalayas region of northwestern India is a difficult task. Intercropping is commonly described as a long-term strategy for reducing soil erosion and maximizing resource utilization. The field study was carried out at the Norman E. Borlaug Crop Research Centre (CRC), G.B. Pant University of Agriculture and Technology, Pantnagar, Uttarakhand, during the monsoon season of the Kharif season, to observe the significant effect of land slopes and intercropping on productivity and resource conservation. According to the findings of this study, maximum runoff, sediment yield, and nitrogen loss were observed in the barren plot at a slopes in 8% followed by 5, 2% in the barren land. Among cropping patterns, intercropping of one row maize and soybean, two-row maize and soybean (M2+S2), and sole maize resulted in the greatest surface runoff reduction. Thus, decreasing surface runoff, soil loss, and nitrogen loss while increasing crop growth on sloppy and barren land.

Keywords: Maize, Soybean, Slope, Intercropping, sediment, nutrient loss

ESTIMATION OF VARIABILITY PARAMETERS FOR SEED YIELD AND YIELD CONTRIBUTING TRAITS IN INDIAN MUSTARD (*Brassica juncea* L)

SABYASACHI SAHU, S.K. TEWARI, USHA PANT, B. SUDHAKAR REDDY
Dept of Genetics & Plant Breeding, GBPUA&T Pantnagar, Uttarakhand

ABSTRACT

The primary condition for incorporating desired traits to maximise economic yields is knowledge on the type and extent of genetic variability existing in a population for desirable traits, their relationship, and relative contribution to yield. The goal of the current research was to determine the genetic variability, heritability, and genetic advance in fourty four Indian mustard (*Brassica Juncea* L.) advanced generation lines along with checks. A randomized block design with three replications was used to assess the experimental material in rabi 2020. Phenotypic coefficient of variation (PCV) was high than Genotypic coefficient of variation (GCV) for all characters. Higher values of GCV and PCV found in number of secondary Branches, 1000 seed weight while moderate in siliqua on main raceme and number of primary branches. High heritability along with high genetic advance as percentage of mean were found for number of secondary branches, 1000 seed weight.

IMPACT OF DISASTERS IN HUMAN, ANIMAL AND ENVIRONMENT

NIVEDITA KHIRIYA AND SANDEEP KUMAR

Department of Veterinary Public Health and Epidemiology, College of Veterinary & Animal Science, Udaipur, (RAJUVAS), Rajasthan, India-313601

ABSTRACT

Disaster is when hostile forces quickly and significantly disrupt the available resources. On all parties involved, it leaves a serious physical, emotional, social, and financial wound. Numerous humans, animal and environment are impacted by disasters all throughout the world, regardless of their location, race, or economic standing. In actuality, they are now a common occurrence. Nearly every day, you hear of disasters occurring in one part of the world or another. To take corrective action, we need to understand how disasters affect people, companies, governments, and the environment. Many of the consequences of disasters are the same for both natural and man-made disasters.

Keywords: Disaster, human, animal, environment, impact

ROLE OF *Trichoderma* SPECIES AND THEIR SECONDARY METABOLITES IN THE IMPROVEMENT OF CHILLI HEALTH AND YIELD

NASREEN MUSHEER* AND ANAM CHOUDHARY

Glocal University, Saharanpur and Aligarh Muslim University, Aligarh

ABSTRACT

Trichoderma, a filamentous soil inhabiting ubiquitous fungus, offers multifarious activities to benefits plants include: control phytopathogenic fungi, improve plant growth and increase soil fertility. It is used as a biofungicides and biofertilizers in sustaining many crops especially vegetable crop. Most the herbaceous crops at seedling stage are sensitive towards biotic and abiotic constrains, which emphasised the healthy seedling development. Among the vegetables, chilli (*Capsicum annum* L.) is an important annual herbaceous vegetable and spice grown in tropical and subtropical region throughout the world. The study was aimed to

determine the impact of *Trichoderma* strains and their secondary metabolites such as harzianic acid (HA) and viridin on the percent seed germination and seedling vigour for higher crop production under polyhouse conditions. The two *Trichoderma* strains namely, *T. harzianum* and *T. viride* were isolated from *Curcuma longa* L. (turmeric) rhizosphere and used to treat the chilli seeds. For dry chilli seeds (100 in numbers) coating, 5×10^5 cfu ml⁻¹ spore suspension of each *Trichoderma* species was prepared with 2% starch (2gm of starch per litre of water) as an adhesive to evaluate the percent seed germination and seedling vigour in chilli crop. Among the two *Trichoderma* strains, *Trichoderma harzianum* along with harzianic acid was found most effective in improving the percent seed germination and seedling vigour over untreated seeds. Also, higher vigour index values with better germination of chili seeds after *T. harzianum* seed coating help in reducing the seed dormancy. Thus, study results concluded that *Trichoderma* is an effective substitute of chemical fertilizers and fungicides that helps to overcome the residual risk development in animal, human and environment health and it could be used as biofungicides and biofertilizers in improving the crop protection and production.

Keywords: *Trichoderma*; Chilli; Secondary metabolites; seed germination; seedling vigour.

EFFECT OF INORGANIC FERTILIZER, ORGANIC MANURES AND NANO UREA ON GROWTH PARAMETERS OF GARLIC (*Allium sativum* L.)

RAJESH CHOUDHARY^{1*} M R CHOUDHARY^{1*}, MURARI LAL CHOPRA¹, ASHOK CHOUDHARY² ANITA CHOUDHARY¹ KIRAN CHOUDHARY¹ AND SUNIL KUMAR YADAV¹

¹Department of Horticulture, Sri Karan Narendra Agriculture University, Jobner, Jaipur-303328.

²Department of Horticulture, College of Agriculture, GBPUAT, Pantnagar- 263145

ABSTRACT

The present investigation entitled “Effect of inorganic fertilizer, organic manures and nano urea on growth parameters of garlic (*Allium sativum* L.)” was conducted at S. K. N. College of Agriculture, Jobner (Rajasthan) during 2020-21 and 2021-22. The experiment comprising of 24 treatment combinations with six levels of inorganic fertilizers, organic manures alongwith biofertilizers the treatments with their symbols are described as under (O₁B₀ – 100% RD via Inorg. Frt. without Biofert, O₁B₁ – 100% RD via Inorg. Frt. with Biofert, O₂B₀ – 75% RD via Inorg. Frt. & 25 OM without Biofert, O₂B₁ – 75% RD via Inorg. Frt. and 25 OM with Biofert, O₃B₀ – 50% RD via Inorg. Frt. and 50% OM without Biofert, O₃B₁ – 50% RD via Inorg. Frt. and 50% OM with Biofert) and four levels of nano urea (N₀-control, N₁-Nano urea @ 25 ml/ha, N₂-Nano urea @ 50 ml/ha, N₃-Nano urea @ 75 ml/ha) in Split Plot Design with three replications. The application of treatment 100% RD of N through inorganic fertilizers + biofertilizer inoculation recorded significantly maximum plant height (27.64 cm), number of leaves (4.96 cm), and chlorophyll content (1.85 mg/g). Further, the foliar application of nano urea @ 75 ml/ha being at par with foliar application of nano urea @ 50 ml/ha and significantly increased in growth parameters viz., increment in plant height (27.48 cm), number of leaves and chlorophyll content (1.83 mg/g).

Keywords: Nano urea, plant, growth, number of leaves and chlorophyll

BIODIVERSITY OF NORTH-EAST INDIA AND SEED AS MAJOR ENIGMA FOR CONSERVATION

NAFLATH, T. V., RAJENDRA PRASAD, S. AND NAGARAJU, K. S.

**Department of Seed Science and Technology, University of Agricultural Sciences,
Bengaluru-560065**

ABSTRACT

Northeast India is the easternmost region of India representing both a geographic and political administrative division of the country. It has the richest reservoir of plant diversity in India and supporting about 50% of India's biodiversity. About 40% of flowering plants of the area are endemic to the region. The region is the home to many botanical curiosities and botanical rarities. There is an urgent need of actions to promote conservation and sustainable use of the forests and forest resources of Northeast India. Biodiversity shows the richness of a country in terms of economy, culture and knowledge. Future progress in crop improvement and our food security depends to a great extent on the immediate conservation of the rapidly vanishing crop gene resources and their effective utilization by plant breeders. Seed is the fertilized ovule consisting of food reserve and a protective coat. So the seed is self-protected from unsafe environmental condition by having extra appendages, mechanism of dormancy, phenolic contents *etc.* The seed is the most vital and crucial input for the conservation of Rare, Endangered and Threatened (RET) plant species. The sexual cycle of reproduction assures mechanism of reproduction and multiplication of these species by the formation of seeds. The provenance of seed material used in ecological conservation or habitat creation is a prominent source and means for a success result. The genetic diversity and seed polymorphism are the key facts one conservator must anticipate and practice for successful conservation. Often collected RET medicinal and aromatic plants are assumed to be true to type i.e. they have attained homozygosity. Until and unless the genetic purity in terms of attainment of homozygosity is attained the conservation of a particular RET plant will be questionable. For the conservation of cross-pollinated species attention should be given to select the homozygous plants from the Mendelian population of such species. The progeny of a cross-pollinated species contains fifty per cent homozygous and fifty per cent heterozygous plants, according to Mendel's law of segregation and independent assortment. Diversity assessment in the natural population and collection has to be planned for the successful conservation. The variation in seed dormancy and the subsequent patterns of seedling emergence are largely known to be controlled by environmental conditions. Dormancy is an important phenomenon in the seed to conserve the biodiversity that will escape the unfavorable conditions of the environment. So the seed itself is a source of biodiversity conservation.

Keywords: Biodiversity, Conservation, Dormancy, Seed, Seed polymorphism

ECO FRIENDLY SOLUTION TO COMBAT NUTRITION DEFICIENCY USING MICROGREENS AND NANO TECHNOLOGY (F SHEET)

JEEVA.M¹, AJAY PATTABIRAMAN² and PAVITHRA VERTHIKERE RAVI³

¹Nanogene Bionest, PSGCAS step, Coimbatore, Tamil Nadu,

²Primary Health Centre, Anaikatti, Coimbatore, Tamil Nadu, Founder, Nanogene Bionest, PSGCAS step, Coimbatore, Tamil Nadu,

³Sri Ramakrishna Engineering College, Coimbatore, Tamil Nadu,

Co-Founder, Nanogene Bionest, PSGCAS Step, Coimbatore, Tamil Nadu.

ABSTRACT

Creating sustainable farming techniques and maintaining food security have become two of the top problems in the agriculture sector. There is an increased global demand for food and a rise in nutritional deficiencies as a result of the world's population growth, which has prompted calls for new sustainable agricultural practices. Nanotechnology in conjunction with soilless and microgreen farming may offer a revolutionary answer as well as a more productive and sustainable alternative to traditional farming. F sheet is a declaration of intent to live healthily. F-sheets are foldable farm sheets with an eco-friendly base that is 3D printed (3-5 cm thick), with jute fiber as the plant substrate which is biodegradable, and organic seeds mixed into the substrate using soluble paper and nanoparticles as the binding agent. These materials are enriched with essential plant nutrients and minerals. By better managing nutrients and water, nanoparticles in soilless farming primarily aim to reduce nutrient losses while also enhancing yields. Due to their high specific surface and related reactivity, nanoparticles can provide the plant with more soluble and usable forms of nutrients. Additionally, F sheets allows controlled release of active nutrients, to ensure that the necessary nutrient is available throughout the growing process. So, nanotechnology could be exploited to preserve the microgreens in F sheets, thereby extending their shelf life. Based on the Nutritional requirement of the customer, F sheets can be customized and sold in variety of types like, Infant model, Workout/gym/CrossFit Model, Gestation/Pregnancy Model and General Model. F-sheet offers biodegradable, environmentally friendly, and very economical planters to enhance organic consumption around the year and simple gardening/zero cropping in less space with high durability and sustainability. F sheet is committed to provide healthy and nutritious food to every household in an affordable prize to promote better lifestyles. F sheet has been filed for patent and is waiting for its approval.

EFFECT OF MACRO AND MICRONUTRIENT ON GROWTH PARAMETERS OF LEMON (*Citrus limon* L.)

MURARI LAL CHOPRA*, K K MEENA, RAJESH CHOUDHARY, KAMAL MAHALA AND SUNIL KUMAR YADAV

Department of Horticulture, Sri Karan Narendra Agriculture University, Jobner, Jaipur-303328.

ABSTRACT

The present investigation entitled “Effect of macro and micronutrient on growth parameters of lemon (*Citrus limon* L.)” was conducted at S. K. N. College of Agriculture, Jobner (Rajasthan) during 2021 on four years old uniform plants of lemon var. Pant Lemon-1. The experiment comprising of 16 treatment combinations with four levels of nano nitrogen (N₀-control, N₁ – nano nitrogen @ 1.50 ml/plant, N₂ – nano nitrogen @ 3.0 ml/plant and N₃ – nano nitrogen @ 4.50 ml/plant) and four levels of zinc sulphate (Z₀-control, Z₁- ZnSO₄ @ 0.40 %, Z₂- ZnSO₄ @ 0.80 % and Z₃- ZnSO₄ @ 1.20 %) in Factorial Randomized Block Design with three replications. The application of treatment N₃ (Nano nitrogen @ 4.50 ml/plant) significantly increased growth characters viz., increment in plant height (27.64 cm), plant girth (4.96 cm), plant spread N-S (28.35 cm), plant spread E-W (30.02 cm), shoot growth (15.43 cm) and chlorophyll content (1.85 mg/g). Further, the foliar application of treatment Z₂ (ZnSO₄ @ 0.80 %) significantly increased in growth parameters viz., increment in plant height (27.48 cm), plant girth (4.91 cm), plant spread N-S (28.31 cm), plant spread E-W (30.12 cm), shoot growth (15.33 cm) and chlorophyll content (1.83 mg/g).

Keywords: Nano nitrogen, plant, growth, girth and chlorophyll

THE EFFECT OF NITROGEN ON GROWTH, YIELD AND QUALITY OF BEETROOT

ANITA CHOUDHARY* AND RAJESH CHOUDHARY

Department of Horticulture, Sri Karan Narendra Agriculture University, Jobner, Jaipur
ABSTRACT

A field experiment was conducted to study the during *rabi* season 2020-21 at Horticulture Farm, S.K.N. College of Agriculture, Jobner (Rajasthan). The experiment consisted of twelve treatment combinations including four nitrogen levels (control, 30 kg N/ha, 60 kg N/ha & 90 kg N/ha) and three treatments of plant geometry (15 x 10 cm, 30 x 10 cm & 45 x 10 cm) were under taken in factorial randomized block design with three replications. The results of the study clearly indicated that application of nitrogen 60 kg per ha to beetroot significantly. However, the application of 60 kg N per ha was significantly increased root diameter, length of root, shoot: root ratio, root weight.

Keywords: Plant, nitrogen, growth and root

Mesorhizobium IMPROVES CHICKPEA GROWTH UNDER CHROMIUM STRESS AND ALLEVIATES CHROMIUM CONTAMINATION OF SOIL

HUMA NAZ^{1,*}, RIYAZ Z. SAYYED², RIYAJ UDDIN KHAN³ ASMA NAZ⁴, OWAIS ALI WANI⁵, AYESHA⁶ AND SAMIYA⁷, ALI FAHAD⁸, SHABBIR ASHRAF¹

¹Faculty of Agriculture Sciences, Department of Plant Protection, Aligarh Muslim University, 202002, India

²Department of Microbiology, PSGVP Mandal's S I Patil Arts, G B Patel Science & STKV Sangh Commerce College, Shahada, 425409, India

³Department of Electronics & Electrical Engineering, Indian Institute of Technology (IIT) Guwahati, 781039, India

⁴Mohammed Ali Nazeer Fatima Degree College, Hardoi, 241001, India

⁵Department of Soil Science and Agriculture Chemistry, Sher-e-Kashmir University of Agricultural Sciences and Technology, Kashmir, Wadoora, 190025, India

⁶Krishna College, Bijnor, 246701, India

⁷TUM School of Life Sciences, Technical University of Munich, 80333, Munich, Germany

⁸School of Vocational and Applied Science, Gautham Buddha University, Greater Noida, 201312, India

ABSTRACT

Environmental pollution has become a transnational issue that impacts ecosystems, soil, water, and air, and is directly related to human health and well-being. Chromium toxicity decreases plant and microbial development. The decontamination of chromium-stressed soils via phytoremediation is a cost-effective and environmentally benign method that has gained more attention. Plant growth and chromium remediation efficiency are quickly increased by multifunctional plant growth-promoting rhizobacteria (PGPR), which also possessed characteristics that lowers chromium levels. By altering root architecture, secreting chemicals that bind metals in the rhizosphere, and reducing phytotoxicity brought on by chromium, PGPR increases chromium uptake. In this study, we investigated the bioremediation capacity of metal-tolerant PGPR strain, RC3, against chickpea inoculated with or without strain cultivated in pot experiment treated with 15.13, 30.26, and 60.52 mg/kg of Chromium. *Mesorhizobium* strain RC3 enhances nodulation, chlorophyll, leghaemoglobin, seed production, and grain protein in chromium-grown chickpea. In chickpea crop roots, shoots, and grains, the strain decreased chromium uptake. Due to its growth-promoting and chromium-attenuating qualities, *Mesorhizobium* strain RC3 could be used to repair chromium-contaminated locations.

Keywords: Chromium, Phytoremediation, *Mesorhizobium*, Chickpea, PGPR, Bioinoculant

EFFECT OF INSECTICIDES ON THE MANAGEMENT OF *Scirtothrips dorsalis* ON CHILLI CROP

SURENDRA SINGH SHEKHAWAT* AND M. SHAFIQ ANSARI

Department of Plant Protection, Faculty of Agricultural Sciences, Aligarh Muslim University Aligarh- 202002

ABSTRACT

Experiments were carried out to evaluate the efficacy of insecticides in field condition at Department of Plant Protection, Aligarh Muslim University, Aligarh in 2018 and 2019. A total 14 insecticides; thiamethoxam 25 WG, lambda-cyhalothrin 5 EC, fipronil 80 WG, fipronil 5 SC, profenophos 50 EC, emamectin benzoate 5 SG, imidacloprid 17.8 SL and 70 WG, buprofezin 25, acetamiprid 20 SP, dimethoate 30 EC, flonicamid 50 WG, Azadirachtin 5% were evaluated for the management of *S. dorsalis* and cost-benefit ratio. Results showed highest control was recorded with profenophos and fipronil 80WG (0.06 thrips/leaf) on 1 DAA and density of thrips was below 1 thrips/leaf with all insecticides till 10 DAA while fipronil 5SC and 80WG (0.80 and 0.60 thrips/leaf), emamectine benzoate (0.63), spinetoram (0.36), acetamiprid, flonicamid, imidacloprid 17.8SL and 70WG and thiacloprid (0.36, 0.36, 0.63, 0.46 and 0.76 thrips/leaf) were effective in checking thrips population till 15 DAA in 2018, significantly ($P < 0.05$). During 1st application in 2019, the lambda-cyhalothrin, profenophos and imidacloprid 70WG proved effective in reducing thrips infestation (0.16, 0.16 and 0.10 thrips/leaf) while fipronil 5SC and 80WG, emamectine beanzoate, spinetoram, acetamiprid, flonicamid, imidacloprid 17.8SL and 70WG and thiacloprid (0.76, 0.87, 0.63, 0.50, 0.67, 0.50 and 0.80 thrips/leaf) remained effective till 15 DAA. The maximum cost-benefit ratio was obtained with application of imidacloprid 70WG (1:7.21), acetamiprid (1:6.03) while minimum with buprofezin and spinetoram (1: 1.65 and 1.97) in 2018 and highest with imidacloprid 70WG (1: 5.22) and lowest with buprofezin and spinoteram (1: 1.16 and 1.57).

Keyword: *Scirtothrips dorsalis*, insecticide efficacy, management, cost-benefit ratio

BIOLOGY OF FALL ARMYWORM, *Spodoptera frugiperda* (NOCTUIDAE: LEPIDOPTERA) ON DIFFERENT CEREAL HOST PLANT

PHOOL SUMERA AND PARVEZ QAMAR RIZVI

Faculty of Agricultural Sciences, Department of Plant Protection, Aligarh Muslim University, Aligarh, India

ABSTRACT

This laboratory study was conducted to evaluate the growth and development of fall army worm *Spodoptera frugiperda* (J E Smith) on three cereal host plants. Incubation period was 2 days on maize and pearl millet followed by sorghum (2.26 days).and Highest egg hatch observed on maize and followed by sorghum (89%) and pearl millet (84%). Shortest larval duration noticed on maize (12.58 days) followed by sorghum (15.93 days), pearl millet (16.93 days) and Highest pupation registered on sorghum (91 per cent) followed by maize (88 per cent), and pearl millet (71 per cent). The lowest pupal duration recorded on maize (6.74 days) followed by pearl millet (7.61 days), sorghum (7.99 days) and Highest adult longevity of male on maize (6.29 days) Maximum adult longevity of female on maize (8.46 days) and Lowest total life cycle duration of male on maize (27.61 days) followed by pearl millet (30.85 days), sorghum (31.31 days) and Minimum total life cycle duration of female on maize (29.78 days) followed by sorghum (32.52 days), pearl millet (33.34 days). Highest oviposition period on maize followed by sorghum, pearl millet (1.88, 1.14, 1.20 and respectively). Fecundity was highest on maize (436.44) followed by pearl millet (139.30) and sorghum (106.44).

Keywords: *Spodoptera frugiperda*, maize, pearl millet, sorghum, fecundity, egg hatching, larval instars, larval, pupal, adult.

**NEW RECORD OF SIX-SPOT GROUND BEETLE *Anthia sexguttata* (Fabricius, 1775)
(Coleoptera: Carabidae), A BIOLOGICAL PEST CONTROLLER, FROM
JEHANABAD, BIHAR (INDIA)**

AKHLAQ HUSAIN¹ AND WAJID HASAN²

¹ (former Scientist, Zoological Survey of India)

41, Hari Vihar, Vijay Park, Chakrata Road, Dehra Dun, Uttarakhand, India

²Krishi Vigyan Kendra, Jehanabad, BAU, Sabour, Bihar, India

ABSTRACT

The present communication deals with the new record of *Anthia sexguttata*, the Six-spot Ground Beetle, belonging to family Carabidae, from Jehanabad, Bihar (India). Their adults feed on agriculture pest mainly on soil and seeds of weeds etc. but they also sometimes ascend to vegetation around in search of their preferred food and hence are considered the beneficial predators as playing a major role in biological control of insect pests and unwanted weeds affecting the main crops in agricultural fields. Their larvae, which mostly subsist on pests in soil, also help in their control. In view of their importance a detailed account is provided here.

Key-words: New record, *Anthia sexguttata*, Jehanabad, Bihar.

**ESTIMATION OF G X E INTERACTION BY AMMI MODEL IN SOME ELITE
CHICKPEA (*Cicer arietinum* L.) Genotypes**

**ARVIND CHAUHAN *, ANJU ARORA, R.K.PANWAR, S.K.VERMA, SHREYA,
NIMITA KANDWAL AND ANUPRIYA RANA.**

Department of Genetics and Plant Breeding, G.B. Pant University of Agriculture and Technology, Pantnagar, Uttarakhand-263145

ABSTRACT

The G x E interaction was studied in chickpea genotypes using AMMI model. Ten elite chickpea breeding lines along with two check varieties (HC5&GNG2171) were grown in five different environments during *rabi* 2020 and *rabi* 2021 at crop research centre GBPUA&T Pantnagar, Uttarakhand. Five different environment were created by following different dates of sowing in viz. early sown, timely sown and late sown during first year and timely and late sown during second year of experiment. The results indicated that main effects as well as G x E interaction effects were significant for most of the traits indicating broad range of diversity among genotypes and differential performance of genotypes over the environments. Major portion of the G x E was contributed by the environment. AMMI model having two principle components axis was found as the best predictive model in this study. AMMI biplots, ASV and YSV indicated PG289 to be the most stable genotype for seed yield during in all five environments.

Keywords: Chickpea, Genetic variation, cold tolerance, pollen germination.

INTEGRATED NUTRIENT, WEED, DISEASE AND PEST MANAGEMENT

AKANSHA VERMA*, JHABAR MAL TETARWAL¹

*Swami Keshwanand Rajasthan Agricultural University, Bikaner Rajasthan 334006

¹Animal husbandry expert GLIU JSM-BRM (GEF) FAO

ABSTRACT

Insect pests, diseases and weeds are interlinked and complement each other. Personally, each any such is accountable for a great loss via itself information if one stays overlooked; it gives rise to the infestation of the alternative. Some bugs secrete a sugary substance on which fungi develop. Weeds serve as the alternate host for rust and other fungi, and additionally harbour insect pests. Therefore, for green insect pests and disorder management, it's miles vital to additionally control weeds. Everyday removal of weeds is a form of preventive manipulate as it minimises opposition of nutrients, prevents hibernating pests, as well as, helps proper aeration and alertness of insecticides. The key in the back of the achievement of insect pests, diseases and weed management lies in early and best detection of maladies and their management. Eradicating and treating assets of inoculate within the area are vital preventive measures. Reinforce the crop through maintaining soil fertility, drainage and aeration check infection from soil, and broaden resistance in the crop in opposition to pest attack. Infections within the crop can be soil-borne, aerial or seed-borne. further, some insect pests suck the cell-sap of the crop, some bite the foliage and floral elements, some bore into the stems, buds and fruits, at the same time as there are bugs where their larvae mine the leaves and every now and then even the stems Each of these problems and infestations need specific approach towards prevention and control. For an effective strategy on pest management, it is essential together technical know-how on identification of the pests. This will be useful for appropriate selection of pesticide with its specific dose, method and time of application.

Keyword: interlinked, nutrients, soil fertility, diseases

HI TECH HORTICULTURE FARMING USHERED IN A NEW ERA

POOJA KUMARI

Department of Horticulture, RCA, MPUAT, Udaipur, (Raj.) 313001

ABSTRACT

The conventional method of farming cannot manage with the increased demand, so it is required to ameliorate the technologies in the agriculture field, In recent years, with the increase in population, there has also been an increase in the demand for food and nutritional security. The horticultural sector provides great scope for the use of Hi technology in this area since by cultivating on a small area of land, the productivity is higher (especially for vegetables, flowers, and medicinal crops) as compared to other agronomic crops. Hi-tech horticulture has enormous potential for producing large quantities of high-quality produce. Hi-tech horticulture can be defined as the precision techniques used for the production of crops by using the inputs efficiently at the proper time and quantity to improve the yield and quality of the produce. It uses farming technology to increase yields, assure high quality (usually fungicide- or pesticide-free), and ascertain increased market value (NABARD, 2019). Protected cultivation is a method of growing crops in a controlled environment in which the temperature, light, relative humidity, etc. can be controlled. The different types of protected structures include greenhouses, glass houses, shade nets, fully automated greenhouses, etc. Advantages of protected structure are that the crops can be protected from adverse weather condition and can be cultivated in off season with use of suitable varieties. Under a protected

structure hybrid Seed and seedlings can be produced for High Value Horticultural Crops (National policy paper 13, 2001).

Keywords: Greenhouses, Glass Houses, Shade Nets, Fully Automated Greenhouses, Hi-Tech Horticulture etc.

MICRONUTRIENTS IN FOOD PRODUCTION: WHAT CAN WE LEARN FROM NATURAL ECOSYSTEMS

PRAKASH CHAND GURJAR

Rajasthan College of Agriculture, MPUAT, Udaipur (Raj.)

ABSTRACT

Soil micronutrients limit crop productivity in many regions worldwide, and micronutrient deficiencies affect over two billion people globally. Microbial bio fertilizers could combat these issues by inoculating arable soils with microorganisms that mobilize micronutrients, increasing their availability to crop plants in an environmentally sustainable and cost-effective manner. However, the widespread application of bio fertilizers is limited by complex micronutrient–microbe–plant interactions, which reduce their effectiveness under field conditions. Here, we review the current state of seven micronutrients in food production. We examine the mechanisms underpinning microbial micronutrient mobilization in natural ecosystems and synthesize the state-of-knowledge to improve our overall understanding of bio fertilizers in food crop production. We demonstrate that, although soil micronutrient concentrations are strongly influenced by soil conditions, land management practices can also substantially affect micronutrient availability and uptake by plants. The effectiveness of bio fertilizers varies, but several lines of evidence indicate substantial benefits into-applying bio fertilizers with conventional inorganic or organic fertilizers. Studies of micronutrient cycling in natural ecosystems provide examples of microbial taxa capable of mobilizing multiple micronutrients whilst withstanding harsh environmental conditions. Research into the mechanisms of microbial nutrient mobilization in natural ecosystems could, therefore, yield effective bio fertilizers to improve crop nutrition under global changes.

Keywords: Soil Micronutrient Availability; Food Crop Production; Microbial Bio fertilizer; Micro bail nutrient Mobilization; Plant Micronutrient Uptake; Bio fortification etc.

EFFECT OF INORGANIC AND ORGANIC SOURCES OF FERTILIZATION ON NUTRIENT CONTENT, UPTAKE, AND QUALITY OF FENUGREEK (*Trigonella foenum-graecum* L.) UNDER AGRO-CLIMATIC CONDITIONS OF RAJASTHAN

MANOJ

Sri Karan Narendra Agriculture University, Jobner- Jaipur

ABSTRACT

An experiment was laid out during rabi 20119-20 for studying the effect of inorganic and organic sources of fertilization on nutrient content, uptake, and quality of fenugreek. Results revealed that the application of 100% RDF significantly enhanced growth kinetics i.e. CGR and RGR; nitrogen uptake by seed (71.2 kg ha⁻¹) and haulm (104.7 kg ha⁻¹); phosphorus uptake by seed (10.3 kg ha⁻¹) and haulm (17.8 kg ha⁻¹); chlorophyll content (4.42 mg g⁻¹) at 50 per cent flowering and crude protein (22.1%) in seed as compared to lower doses of inorganic sources of fertilization. The escalating levels of inorganic sources significantly improved nitrogen (279.41 kg ha⁻¹) and phosphorus (24.36 kg ha⁻¹) status of soil after harvesting of crop. The application of FYM 5 t ha⁻¹ + Rhizobium + PSB notably increased nitrogen uptake by seed

(67.8 kg ha⁻¹) and haulm (91.8 kg ha⁻¹). Phosphorus uptake was significantly higher with application of vermicompost 2.5 t ha⁻¹ + Rhizobium + PSB. After harvesting of crop, significantly more N (302.32 kg ha⁻¹) and P (23.82 kg ha⁻¹) content in soil was observed under the application of FYM 5 t ha⁻¹ + Rhizobium + PSB. Likewise, quality parameters viz. chlorophyll content (3.38 mg g⁻¹) at 50 per cent flowering stage and crude protein content (21.2%) in seed was significantly higher with the application of FYM 5 t ha⁻¹ + Rhizobium + PSB.

Keywords: Organic, inorganic, nutrient, quality, fenugreek

युवकों के मानसिक एवं शारीरिक स्वास्थ्य तथा स्वास्थ्य जोखिम व्यवहार पर बेरोजगारी के प्रभाव का अध्ययन

कु० प्रतिक्षा¹ एवं डॉ० सीमा रानी^{2*}

¹शोध छात्रा, गृह विज्ञान विभाग, एम० एल० एंड जे० एन० के० गर्ल्स कॉलेज, सहारनपुर, उत्तर प्रदेश।

^{2*}प्रोफेसर एवं विभागाध्यक्ष, गृह विज्ञान विभाग, एम० एल० एंड जे० एन० के० गर्ल्स कॉलेज, सहारनपुर, उत्तर प्रदेश।

सारांश

प्रस्तुत शोध में मुरादाबाद जनपद के कार्यरत् एवं शिक्षित बेरोजगार युवकों के मानसिक तथा शारीरिक स्वास्थ्य एवं स्वास्थ्य जोखिम व्यवहार पर बेरोजगारी के प्रभाव की व्यापकता का विश्लेषण करने का प्रयास किया गया है। तथ्यों का तुलनात्मक अध्ययन करने पर यह स्पष्ट होता है कि लगातार दबाव महसूस करने जैसी समस्या बेरोजगार एवं कार्यरत् युवकों दोनों में सामान्य रूप से पायी गयी। यहाँ पर यह भी कहा जा सकता है कि बेरोजगार युवकों में इस दबाव की स्थिति के लिए सामाजिक एवं पारिवारिक परिवेश उत्तरदायी है जबकि कार्यरत् युवकों में यह दबाव उनके कार्यक्षेत्र की विभिन्न प्रतिकूल परिस्थितियों के कारण उत्तपन्न होता है।

प्रस्तुत शोध अध्ययन में अनुसंधान की रूपरेखा में उद्देश्य, अनुभवजन्य सत्यापन के लिए परिकल्पना, नमूना चयन की प्रक्रिया, आँकड़ों के विश्लेषण के लिए सांख्यिकीय तरीके और आँकड़ें प्राप्त करने के लिए माप के लिए उपयोग किए जाने वाले उपकरण शामिल हैं।

वर्तमान जांच में युवाओं में उनके रोजगार की स्थिति, लिंग और निवास के संबंध में असुरक्षा, मानसिक स्वास्थ्य और अवसाद की भावना का अध्ययन करने का प्रयास किया गया है। इस अध्ययन ने युवा पीढ़ी के बीच मानसिक स्वास्थ्य, सुरक्षा/असुरक्षा के स्तर और अवसाद के बीच संबंधों का भी पता लगाया। प्रतिदर्श में मुरादाबाद जिले से नियोजित और बेरोजगारों की समान संख्या वाले 500 युवाओं को शामिल किया गया है।

आँकड़ों के विश्लेषणात्मक अध्ययन से ज्ञात होता है कि लगभग 88.80% युवकों का मानसिक स्वास्थ्य बेरोजगारी के कारण प्रभावित है। सांख्यिकी विश्लेषण के आधार पर प्राप्त आँकड़ों से यह निष्कर्ष प्राप्त होता है कि शिक्षित बेरोजगार युवकों के मानसिक स्वास्थ्य पर कार्यरत् युवकों की अपेक्षा (04.80%) अधिक प्रभाव पड़ता है। यहाँ पर यह भी विदित है कि जिन युवकों का शारीरिक स्वास्थ्य अधिक प्रभावित था उन्हीं युवकों का मानसिक स्वास्थ्य भी उसी अनुपात में प्रभावित पाया गया।

लगभग 87.20% युवकों का शारीरिक स्वास्थ्य बेरोजगारी के कारण प्रभावित है। अतः सांख्यिकी विश्लेषण के आधार पर प्राप्त आँकड़ों से यह निष्कर्ष प्राप्त होता है कि शिक्षित बेरोजगार युवकों के शारीरिक स्वास्थ्य पर कार्यरत् युवकों (03.60%) की अपेक्षा अधिक प्रभाव पड़ता है। फलतः यह स्पष्ट है कि जिन युवकों का मानसिक स्वास्थ्य अधिक प्रभावित था उन्हीं युवकों का शारीरिक स्वास्थ्य भी उसी अनुपात में प्रभावित पाया गया।

250 बेरोजगार युवकों पर किये गये अध्ययन में स्वनिर्मित प्रश्नावली पर आधारित सांख्यिकी विश्लेषण से प्राप्त आँकड़ों में औसतन 71% युवकों में 5 या उससे अधिक स्वास्थ्य जोखिम व्यवहार पाये गये। लगभग 64% बेरोजगार युवकों में 3 या उससे अधिक स्वास्थ्य जोखिम व्यवहार पाया गया। कुल चयनित न्यादर्श युवकों पर किए गये अध्ययन से ज्ञात होता है कि लगभग 64% युवकों का स्वास्थ्य जोखिम व्यवहार बेरोजगारी के कारण प्रभावित है।

मुख्य शब्द – बेरोजगारी, मानसिक स्वास्थ्य, शारीरिक स्वास्थ्य, स्वास्थ्य जोखिम व्यवहार।

STUDY OF THE IMPACT OF UNEMPLOYMENT ON YOUTH'S MENTAL AND PHYSICAL HEALTH AND HEALTH RISK BEHAVIOR

PRATI KSHA AND SEEMA RANI

Department of Home Science, M.L. and J.N.K. Girls' College, Saharanpur, Uttar Pradesh.

ABSTRACT

In the presented research, the impact of unemployment on the mental and physical health and health risk behavior of the active and educated employed people of Moradabad district has been analysed. Studying the risks, it is clear that the problem of persistent feeling of pressure remains common in both. It can also be said here that social and family responsibilities are responsible for this pressure situation in the stretcher whereas this pressure arises in the living youth due to the different status of their workplace.

Research outline includes objectives, definition for empirical validation, process of sample selection, methods of record making for data analysis and tools used for large to identify.

The present investigation attempts to study the sense of security, mental health and depression among youth in relation to their employment status, gender and residence. The study also explored the relationship between mental health, levels of security/insecurity and depression among the younger generation. The sample consists of 500 youths from Moradabad district with benefit numbers of schemes and estimates.

It is known from the study of statistics works that about 88.80% of the youth's mental health job is affected. The data obtained on the basis of specific analysis, it is concluded that the sharpness of adhesive (04.80%) has more effect on the mental health of the watchmen. It is also known here that the mental health of the youths whose physical health was more affected was found to be affected in the same proportion.

About 87.20% Physical health of humans is affected by employment. Therefore, from the data obtained on the basis of standard analysis, it is concluded that the health of artisan artisans has more impact on the health of artisans. As a result, it is clear that the physical health of the youth, whose mental health was affected, was also found to be affected in the same proportion. In an earlier study of 250 estimates, an average of 71% of the data obtained from standard analysis on self-determination determined 5 or more health risk behaviors in humans. About 64% of the estimates had 3 or more health risk behaviors. Studies conducted on the total selected sample youth show that about 64% of the youth's health risk behavior is affected by unemployment.

Keywords: occupational, mental health, physical health, health risk behaviour.

ADVANCEMENTS AND FUTURE PROSPECTIVE OF DNA BARCODES IN ANTICANCER ACTIVITY OF MEDICINAL PLANTS

SAPTARSHI BISWAS¹, SHRIKANT SHARMA²

¹Department of Biotechnology, Shri Venkateshwara University, Gajraula, U.P., India

²School of Applied Science, Shri Venkateshwara University, Gajraula, U.P., India

ABSTRACT

In the field of herbal medicine over the past two decades, there has been a global comeback of medicinal plants. The main reason for the adulteration problems in the herbal industries is the increased consumption of therapeutic plants and the products derived from them. As a result, fake and illegal raw materials have an impact on the quality of herbal goods. The identification of adulterants in herbal samples using DNA barcodes, a recent advance in molecular plant identification, has become a reliable technology. So, the key to the herbal industry's success is the quick and precise identification of therapeutic plants. The study's goal is: The application of DNA barcoding and other cutting-edge technologies that have arisen over the past ten years in relation to the identification and authenticity of medicinal plants, as well as the prospects for this technology's future, are thoroughly reviewed in this study. Scientific databases were used to compile data on DNA barcodes (Google Scholar, Web of Science, SciFinder and PubMed). Books, doctoral theses, and master's theses dissertations were used to supplement the content. The single locus-based DNA barcodes (rbcL, ITS, ITS2, matK, rpoB, rpoC, and trnH-psbA) to multi-locus DNA barcodes have become the successful species-level identification among herbal plants since it is difficult to develop an acceptable DNA barcode for plants. Multi-loci have also improved in their ability to authenticate herbal goods. Successful herbal plant/sample identification has been made possible by recent developments in DNA barcoding and related technologies like next-generation sequencing, high-resolution melting curve analysis, Meta barcodes, and mini barcodes. In order to check and logically and effectively quality control the herbal pharmaceuticals, DNA barcoding must be used in conjunction with other procedures. It is proposed that the herbal products might be verified using DNA barcoding methods in conjunction with metabolomics, transcriptomics, and proteomics. The future focus of pharmacopoeial monograph development for herbal pharmaceuticals will be the creation of easy, affordable, and enhanced DNA barcoding techniques to identify herbal drugs and their associated compounds of therapeutic value in a fool-proof manner.

Keywords: DNA Barcode, anti-cancer cells, medicinal plants

INSECTS AS BIOINDICATORS OF ENVIRONMENTAL CHANGES

DEEPENDRA KUMAR SAINI

Department of Entomology, Rajasthan college of Agriculture, Maharana Pratap University of Agriculture and Technology, Udaipur, Rajasthan 313004

ABSTRACT

Industrial revolution, intensive agriculture and growing human population are causing extensive exploitation of natural ecosystem. Responses of some species (insects, bats, frogs, fishes, plants etc.) to disturbances can be used as a parameter of analysis about levels of change in the environment. Bioindicators are the species or species group that reflects the abiotic or biotic state of an environment, represents the impact of environmental change on a habitat, community and ecosystems. McGeoch (1998). The mouthpart deformities in Chironomid larvae (Diptera) were investigated in relation to sediment contamination in the Shiroro Lake in

Nigeria. Metals and chironomids were sampled monthly at three stations (A–C) between August 2013 and January 2014. Mouthpart deformities were significantly higher at Station A compared with Station C, and seasonally significantly higher during dry season compared with wet season. Strategies need to be developed to reduce the contaminations and the biological effects (Arimoro et al., 2018). Butterflies have ecological faithfulness to their habitat but changes in habitat due to degradation by environmental stresses such as mining, agriculture and pollution cause reduction in their species richness and abundance (Kyerematen et al., 2018). Winged termites *Reticulitermes* sp. When these insects come out of the soil in a group after rainfall occurs, it is believed that rain will not come again for some time. If there was no rain in the previous day or week but the insects are coming out of the soil, rain is expected to come soon so they act as an indicator for the occurrence of rain Chinlampainga et al (2011). A strong understanding of insect responses to environmental changes is necessary both to support policy decisions for conservation and to evaluate functional consequences of human disturbance on ecosystem. Insects have many potential representatives that can be successfully used as bioindicators for environmental changes.

Keywords: Bioindicators, Intensive agriculture, Pollution, Insects, Metals, ecosystem.

CLIMATE CHANGE AND ABIOTIC STRESS MANAGEMENT”

SONAL ATHNERE

Department of Agronomy, MPUAT, Udaipur, Rajasthan, India

ABSTRACT

As a result of human activity, the amount of carbon dioxide (CO₂) in the atmosphere has increased. This change has an impact on climate, changing the seasonality, length, and intensity of rainfall patterns as well as increasing the likelihood of drought, waterlogging, and evapotranspiration. This has a negative impact on the growth, production, and quality of the plants grown in this environment. Plant stress, plant responses to various types of stress, and plant stress management techniques have all been studied in an effort to create stress tolerant/resistant plants and increase crop productivity. The various abiotic stressors that affect plants and how climate change affects them need to be thoroughly discussed, as well as how these plants react to various abiotic stresses or a combination of stresses and how to manage abiotic stress.

Keywords: Climate, abiotic stress, development, plants etc.

DEVELOPING CLIMATE CHANGE RESILIENT CROP

DEVENDRA KUMAR VERMA

Department of Agricultural Economics and Management, Maharana Pratap University of Agriculture and Technology, Udaipur, Rajasthan, India

ABSTRACT

The frequency and severity of various abiotic stresses, such as droughts, heat waves, cold snaps, and flooding, are alarmingly increasing due to global warming and climate change. This has an adverse effect on crop yields and contributes to food shortages. The composition and behaviour of various insect and pathogen populations are changing as a result of climate change, which is increasing yield losses globally. The rising levels of pollutants produced by humans and the detrimental effects of climate change on soil microbiomes place additional restrictions on agriculture. Although we are trained to examine the effects of individual stress conditions on plants in the lab, in the field, numerous stresses, pollutants and pests may have

an impact on plants at the same time or in succession, leading to conditions of combinational stress. Therefore, when combined with other factors, strategies to increase a crop's tolerance to a specific stress may not succeed in increasing tolerance to that particular stress. Here, there is need of recent research on how various plant species respond to various stressors and suggest new strategies and directions for cultivating resilient crops to both stressors and climate change.
Keywords: Climate change, strategies, crops, mitigation etc.

IMPACTS OF CLIMATE CHANGE ON INDIAN AGRICULTURE

JITENDRA SUMAN AND P. S. SHEKHAWAT

Department of Agril. Economics, Sri Karan Narendra Agriculture University, Jobner, Jaipur, Rajasthan

ABSTRACT

Indian agriculture is highly prone to the risks due to climate change; especially to drought, because 2/3rd of the agricultural land in India is rainfed and even the irrigated system is dependent on monsoon rain. Flood is also a major problem in many parts of the country, especially in eastern part, where frequent flood events take place. In addition, frost in north-west, heat waves in central and northern parts and cyclone in eastern coast also cause havoc. In recent years, the frequency of these climatic extremes are getting more due to the increased atmospheric temperature, resulting in increased risks with substantial loss of agricultural production. Climate change can affect agriculture through their direct and indirect effects on the crops, soils, livestock and pests. Increase in ambient CO₂ rise temperature that reduced crop duration, increase crop respiration rates, alter photosynthesis process, affect the survival and distributions of pest populations and thus developing new equilibrium between crops and pests, hastens nutrient mineralization in soils, decrease fertilizer use efficiencies, and increase in evapo-transpiration. Climate change also have considerable indirect effect on agricultural land use in India due to availability of irrigation water, frequency and intensity of inter- and intra-seasonal droughts, floods, decline in arable areas due to submergence of coastal land, and availability of energy. Under elevated CO₂ concentration, crop residues have higher C: N ratio, which may reduce their rate of decomposition and nutrient supply.

Keywords: Agriculture, climate change, rainfed, Monsoon, flood, CO₂ etc.

EFFECTIVE VALUE CHAIN MANAGEMENT TO IMPROVE LIVELIHOOD SECURITY OF MILK PRODUCERS

LAKSHEETA CHAUHAN^{1*}, RAMESH CHAND BUNKAR²

1Rajasthan College of Agriculture, MPUAT, Udaipur. 313001 (Raj.)

2Division of Dairy Extension, NDRI, Karnal. 132001 (HR)

A value chain is a set of activities that a firm operating in a specific industry performs to deliver a valuable product for the market. Livestock plays an important role in Indian economy as it contributes about 20.5 million people rely on livestock for their livelihood. Livestock provides livelihood to two third of rural community. As we all know India is number one milk producer in the world. It is producing about 198.40 million tones of milk in a year (2019-20). Not only milk but milk products are rich in calcium and also provide various essential nutrients i.e. easily accessible to the body. Milk producers in rural areas should have the effective management of value chain so that they can get benefit they want. The objective of this study is to establish the effective value chain management to improve livelihood of milk producers in rural areas. Analysing the best value chain management of selected area a case study was conducted at

Dholpur district of Rajasthan. Improvement of livelihood security can be achieved through good value chain management with the value addition of dairy product by milk producers. The potential of farmer to participate more equitably in markets can increase their ability to earn more sustainable income and at the same time strengthening the value chains through the input and involvement as producers, workers, entrepreneurs and consumers.

Keywords: Value chain, Management, Livelihood, Milk producers, Improvement

WORLDWIDE EDUCATION POLICIES AND NATIONAL EDUCATION POLICY 2020

RAMESH CHAND BUNKAR^{1*}, LAKSHEETA CHAUHAN²

1. Department of Agricultural Extension and Communication, PGI,MPKV,Rahuri(MH)

2. Rajasthan College of Agriculture, MPUAT, Udaipur. 313001 (Raj.)

ABSTRACT

Education is a human right, a powerful driver of development and one of the strongest instruments for reducing poverty and improving health, gender equality, peace and stability. The Education Policy Outlook is an analytical observatory that monitors the evolution of policy priorities and policy developments from early childhood education to adult education, mainly among organization for Economic Co-operation and Development education systems, to provide a comparative understanding of how policies are evolving, and how they can be best implemented or improved over time. For individuals, education promotes employment, earnings, health and poverty reduction. Globally, there is a 9% increase in hourly earnings for every extra year of schooling. For societies, it drives long-term economic growth, strengthens institutions and fosters social cohesion. The Government of India took several initiatives to improve and promote education in the country after independence. NPE 1968 was also implemented after independence to improve the Indian education system. NPE 1968 was framed to equalize educational opportunities across the country. It aimed at creating an education system that can provide unrestricted access to education. This policy focused on the development of values for national integration because it acknowledged the power of education for the country's economic and cultural development.

Keywords: Economic, Education, Global, National, Policy,

ORGANIC HORTICULTURE: A HEALTHY APPROACH IN THE MODERN WORLD

RAM LAKHAN MEENA AND RAJA RAM BUNKER

Department of Horticulture,RCA,MPUA&T, Udaipur, (Raj.) 313001

ABSTRACT

Horticultural crops, mainly fruits and vegetable share consumed on daily basis and are called as protective food but the trends of high yielding varieties (require lot of fertilizers) and newly emerging pests and diseases are changing this title. These made farmers to use more chemical fertilizers and pesticides which are harmful to environment as well as human. Farmers have no idea regarding this harmful impact and chemicals are being used indiscriminately. The best solution to combat this problem is promoting organic farming (organic agriculture or organic horticulture) among the farmers. Presently India holds 6th position in terms of largest certified organic area having 30% of the total organic producers in the world with 2.30 million hectare of organic farming land. The National Project on Organic Farming (NPOF) and National Horticulture Mission (NHM) scheme of Department of Agriculture and Cooperation is

significantly contributing to growth of Organic farming. Organic farming or Organic horticulture is the integrated and sustainable approach where all the aspects of farming system are interlinked with each other and produce nutritious, healthy, palatable and safe food (fruits, vegetables, spices and medicinal crops) by utilizing on-farm inputs like crop residues, organic formulations (eg.: jeevamrutha, panchagavya), animal waste, botanicals, bio-fertilizers and bio-pesticides, with complete exclusion of off farm inputs. Biodynamic agriculture, rishi krishi, panchagavya krishi and homa organic farming are the prevailing organic production systems in India. Since organic farming keeps away with almost all synthetic inputs like chemical fertilizers and chemical pesticides, also shows a superior environmental performance per unit area than conventional agriculture therefore it can be adapted for sustainable agriculture and healthy lifestyle.

Keywords: organic farming, chemical fertilizers, bio-pesticides, biodynamic agriculture

***IN VITRO* SHOOTS PROLIFERATION FROM DIFFERENT EXPLANTS IN POMEGRANATE (*Punica granatum* L.)**

REKHA CHOUDHARY^{1*}, M. L. JAKHAR² AND SUSHILA CHOUDHARY³

1Division of Genetics and Plant Breeding, RARI, Durgapura, Jaipur (SKNAU, Jobner), Rajasthan, India-303329

2Division of Genetics and Plant Breeding, SKNAU, Jobner, Rajasthan, India-303328

3Division of Plant Pathology, RARI, Durgapura, Jaipur (SKNAU, Jobner), Rajasthan, India-303329

ABSTRACT

Explants and antioxidants have a significant impact on pomegranate in vitro culture. Especially in mature explant, explants and medium browning is a major problem in pomegranate due to the exudation of high amount of phenols. Browning and latent contamination are challenges of the study (Choudhary et al., 2022). As a result, the current study was carried out in order to offer a suitable technique for in vitro cultivation with the least amount of phenolic exudates in order to create virus-free plants that are true to type. Due to the existence of pre-existing meristems, cytokinins have been demonstrated to be beneficial for the induction of numerous shoots from apical/axillary explants in the current study. In fact, such a characteristic has been fully used in the species for micropropagation. Various plant growth regulators, such as cytokinins (BAP/KN) and auxins (IAA/2,4-D), were applied to explants at different concentrations (Tarai et al., 2022). In shoot apex explants, maximum shoot proliferation was recorded on a medium containing 2.5 mg/l BAP, followed by 3.0 mg/l BAP and 2.0 mg/l 2,4-D with 100% frequency. With a 100% frequency, 2.0 mg/l BAP, 2.0 mg/l Kn, and 2.0 mg/l 2,4-D produced the most shoot proliferation in the Nodal section. At higher concentrations (4.0-5.0 mg/l), bud induction was entirely suppressed. At 1.0 mg/l and 5.0 mg/l Kn, the minimum number of shoot buds (1.3) was reported 100% frequency. The induction of shoot buds was gradually decreased as the concentration of BAP (> 2.0 mg/l) was increased.

Keywords: Pomegranate, Shoot proliferation, Micro propagation and Tissue culture.

BROAD STRATEGY FOR IMPROVING FARMERS' INCOME

AKASH TANWAR

Department of Extension Education, Rajasthan college of Agriculture, MPUA&T-
Udaipur(Raj.)

ABSTRACT

We can conclude that agriculture is not only an important component of the primary sector, but it also helps sustain and develop both the secondary and tertiary sectors. Thus, it is the backbone of the economy. Agriculture is the backbone of the Indian economy. improvement in Agricultural Output Viz Productivity: Agronomic output has to be increased through access to irrigation and technological advancement. Resource use efficiency or savings in the cost of production: increase in cropping intensity, i.e., the ratio of net area sown to the total cropped area, by raising short-duration crops after the main Kharif and after the main Rabi seasons so that agricultural land does not remain unused for half of the productive period. Diversification: Toward high-value crops like fruits, vegetables, fiber, condiments and spices, and sugarcane towards other allied enterprises like forestry and dairying rather than depending primarily on crop cultivation. Shifting Cultivators to Non-Farm Occupations: Non-farm sectors provide 2.76 times more productive employment than the agriculture sector in rural areas. Improvement in terms of trade for farmers: use of the CPIAL (consumer price index for agricultural labour) as a deflator to change nominal farm income to real farm income.

Keywords- farmers income, production, diversification

INFLUENCE OF DIFFERENT TRANSPLANTING DATES AND SHOCK PREVENTING METHODS ON YIELD AND ECONOMICS OF PEARL MILLET (*Pennisetumtyphoides*L.) VARIETIES

VIJAY LAXMI YADAV AND RANI SAXENA

Department of Agronomy, Sri Karan Narendra Agriculture University Jobner, Jaipur, Rajasthan, India-303329

ABSTRACT

A field experiment was conducted on loamy sand soil at the Rajasthan Agricultural Research Institute, Durgapura, Jaipur during two consecutive *kharif* seasons in 2019 and 2020. The experiment comprises two pearl millet varieties (RHB-173 and RHB-177), four transplanting shock preventing methods (No treatment, Triacantanol @ 0.25 ml/litre, Triacantanol @ 0.50 ml/litre and Leaf clipping) and three dates of transplanting (15th – 30th June, 1st – 15th July and 16th – 31st July) replicated thrice in factorial randomized block design. Result revealed that pearl millet cultivar RHB-173 proved significantly superior with respect grain yield (2559 kg/ha),stover yield(6301kg/ha), net returns (60148 ₹/ha)and B: C ratio(3.76) were significantly higher with hybrid RHB-173 as compared to RHB-177. Among transplanting shock preventing methods, the pearl millet grain yield (2452 kg/ha), stover yield (5955kg/ha), net returns (56140 ₹/ha) and B: C ratio (3.55) were significantly greater under the treatment triacantanol @ 0.50 ml/litre as compared to no treatment and leaf clipping, but it remained at par with its lower dose treatment triacantanol @ 0.25 ml/litre. Result further revealed that transplanting of pearl millet during 1st – 15th July gave higher grain yield(2376kg/ha), stover yield(5828kg/ha), net returns (54179 ₹/ha) and B: C ratio (3.39) as compared to 15th – 30th June, but it remained at par with transplanting during 16th – 31st July.

Keywords: Pearl millet, varieties, transplanting shock, yield, net returns, B: C ratio

IMPACT OF PHYSIOLOGICAL PARAMETERS ON GROWTH AND SPORULATION OF *Fusarium oxysporum* f. sp. *Lycopersici* CAUSING TOMATO FUSARIUM WILT

SUSHILA CHOUDHARY^{1*}, R.K.BAGRI² AND REKHA CHOUDHARY³

1Division of Plant Pathology, RARI, Durgapura, Jaipur (SKNAU, Jobner), Rajasthan, India-303329

2Division of Plant Pathology, RARI, Durgapura, Jaipur (SKNAU, Jobner), Rajasthan, India-303329

3Division of Genetics and Plant Breeding, RARI, Durgapura, Jaipur (SKNAU, Jobner), Rajasthan, India-303329

ABSTRACT

Fusarium oxysporum f. sp. *Lycopersici* (Sacc.) Snyder and Hansen is a major and serious threats in production of tomato and caused considerable yield losses up to 45 per cent under favorable climatic conditions, that's why considered as an important disease of tomato vegetable. The challenges posed by Fusarium wilt in tomato production are significant, as the disease can lead to reduced yields and pathogen ability to survive in soil and plant debris for extended periods makes management difficult. A Ph.D. experiment was conducted during *kharif*, 2019 and 2020. In present investigation wilt infected tomato roots were collected from Research Farm of RARI, Durgapura, Rajasthan, India and pathogen was isolated, purified and identified with cultural and morphological behavior as per described by Sacc. Snyder and Hansen, further confirmed by Indian Type Culture Collection, New Delhi and confirmed as *Fusarium oxysporum* f. sp. *lycopersici*. To better understand the physiological activities of the pathogen, we investigated the effects of temperature, hydrogen ion concentration, and relative humidity on its growth and sporulation. We found that the maximum mycelial growth (88.51mm) and excellent sporulation were obtained at 25 °C temperature, while the maximum mycelial weight (272 mg) and excellent sporulation were recorded at a pH of 6.5. Additionally, we found that the growth of mycelial (89.10 mm) with abundant sporulation was recorded at 90 percent relative humidity.

Keywords: *Fusarium oxysporum* f. sp. *lycopersici*, Tomato, Physiological activities, Growth and Sporulation.

SEMIOCHEMICALS IN PEST MANAGEMENT

UDAI PAL SINGH

Department of Entomology, Swami Keshwanand Rajasthan Agricultural University, Bikaner, Rajasthan

ABSTRACT

As global biodiversity declines, biodiversity and conservation have become ever more important research topics. Research in chemical ecology for conservation purposes alone cannot work. Semiochemicals are chemicals that change the behaviour of organisms at the nanoscale. Both insects and plants make and use them for communication. The term is derived from Greek word 'semeion' meaning 'signal', a chemical substance that is released by an organism that affect behavior of the other organism. Semiochemicals have been used in three methods to obstruct insect pests' activities: monitoring, mating disruption, and mass capturing and push-pull techniques are highlighted. Semiochemicals are categorized into two classes: communication among individuals of same species (intraspecific) or communication among different species (interspecific). Sex aggregation, alarm, trail, and host-marking pheromones

are examples of intraspecific semiochemicals. Interspecific semiochemicals include allomones and kairomones. By integrating stimuli that act to make the protected resources unattractive while luring them towards an attractive resource, where the pest is then removed, the push-pull strategy manipulates the behaviour of insect pests and their natural enemies. Semiochemicals are important in managing insect pests and hold great promise for controlling many insects through ecologically and environmentally sound means. Semiochemicals are of natural origin, species specific, have low persistence in nature, and are safe for non-target organisms.

Keywords: Semiochemicals, Pest Management, Intraspecific, Interspecific Allomones, Kairomones

PRODUCTION OF F₁ HYBRIDS OF PEARL MILLET USING LINE X TESTER METHOD

KOMAL SHEKHAWAT,¹ P. C. GUPTA

Agricultural Research Station, Bikaner, Rajasthan, India

ABSTRACT

A total of 30 pearl millet hybrids were developed in line x tester fashion during summer 2022 using 10 male sterile and 3 restore lines of pearl millet. These hybrids along with three standard checks of pearl millet were evaluated in a Randomized Block Design with three replications for yield and yield attributes during *kharif* 2022 at Agricultural Research Station, Bikaner. Analysis of variance indicated significant difference among the hybrids for all the characters under study. Among the hybrids three hybrids viz., ICMA 88004 x BIB-6, ICMA 96444 x BIB-.22 and ICMA 15222 x BIB 15 depicted 45,37 and 33% superiority respectively in terms of grain yield over the best check hybrid (RHB -234).

Keywords: Line X Tester, pearl millet, hybrid, Randomized Block Design,

EFFICACY OF FUNGICIDES PLANT EXTRACTS AND BIO-AGENTS ON MANAGEMENT OF ANTHRACNOSE OF CHILLI THROUGH SEED TREATMENTS

CHANDRA SINGH CHOUDHARY

Department of Agriculture Science, Government of Rajasthan

ABSTRACT

Chilli (*Capsicum annum* L.) is an important and widely grown cash crop in India and it cultivated in largest area of the world. The present investigation was carried out by Seed treating of fungicides, plant leaf extract and Bioagents in which the fungicides tested gave significantly higher percentage of seed germination ranges from 77.75 to 93.0 per cent against 68.00 per cent in control. Highest per cent of seed germination (93.00%) was recorded in Bavistin treated seeds followed by Captan (91.00%), Thiram (90.50), Vitavax (84.75%) and Indofil M-45 (77.75%). The result of plant leaf extract for fungicidal / fungistatic property against seed borne *Colletotrichum capsici* indicated that seed treated with leaf extracts of all the plant tested gave significantly higher per cent of seed germination ranges from 77.75 to 94.00 per cent in comparison to control (69.00%). Maximum per cent seed germination was observed in seed treated with leaf extract of safeda (94.00%) followed by neem (92.00%) and Tulsi (90.50%). Maximum per cent seed germination (82.35%) was recorded in *Trichoderma viride* treated seeds followed by *T. harzianum* (81.50%). All the bioagents treated seed significantly increased the seed germination except seed treated with *Pseudomonas fluorescens* (71.56%) as compared to control (70.00%).

Keyword: *Capsicum annum*, Fungicides, *Trichoderma viride*,

ROLE OF POST-HARVEST TECHNOLOGY IN HORTICULTURAL CROPS

DUSHYANT PARIHARI AND CHANDER SINGH CHOUDHARY²

1ICAR- CAZRI, Jodhpur

2Department of Agriculture, Government of Rajasthan

ABSTRACT

The fruits and vegetables have been part of human food. The systematic nutritional value of some fruits and vegetables was recognized in the early 17th century in England. The ability of the citrus fruit to cure scurvy, diseases wide spread among naval personnel. An example of the importance of the field to post-harvest handling is the discovery that ripening of fruit can be delayed, and thus their storage prolonged, by preventing fruit tissue respiration. The knowledge of the fundamental principles and mechanisms of respiration, leading to postharvest storage techniques such as cold storage, gaseous storage, and waxy skin coatings. Another well-known example is the finding that ripening may be brought on by treatment with ethylene. Fruits and vegetables are being rich in vitamins and minerals, known as protective foods. Due to their high nutritive value, ready availability, and being inexpensive they make significantly contributes to human well-being. Realizing the worth of fruits and vegetables in human health ICMR recommend consumption of 120g of fruits and 280g of vegetables per capita per day.

AN ECONOMIC ANALYSIS OF MARKETING OF PAPAYA IN JAIPUR CITY OF RAJASTHAN

¹SUMAN CHAUDHARY, ²OM PRAKASH,

¹Agricultural Economics, SKNCOA, SKNAU, Jobner, Jaipur-303328

²ICAR-ATARI, Zone-II, CAZRI, Jodhpur-342005

ABSTRACT

India is the world's second largest producer of fruits next to China that occupied an area of 6.48 million hectares with a production of 99.07 million tons (Second Advance Estimates) published by National Horticulture Board, during 2019-20. The Papaya (*Carica papaya* L.) is an economically important fruit in India. India is the world's largest producer of papaya with a production of 6.05 million tons in 2019 (FAO Statistical database 2019). Marketing of fruits involves a number of intermediaries performing various functions before it reaches to the hands of ultimate consumers. The intermediaries add to the cost of marketing and also receive a major share of processor's / consumer's prices as their margins. Our study based on the behavior of market power within the distribution chain of perishable agricultural products, taking dynamics and price fluctuation into account. In view of this the present study was undertaken by collecting monthly wholesale prices of papaya in Jaipur city of Rajasthan. This study was based on the primary data for studying the market power of papaya wholesalers and secondary data on arrival and prices of papaya in A.P.M.C., Muhana mandi, Jaipur for the period of 10 years i.e., from 2007-08 up to 2016-17. In the results the market power was measured by two indices namely concentration ratio (CR) and Herfindahl-Hirschman index (HHI). In the analysis the selected market showed increasing trend in the prices of papaya in the selected market and was found to be significant. The findings of cyclical fluctuations in wholesale price of papaya in muhana mandi exhibited one cycle of four years (2010-11 to 2014-15). The irregular fluctuations did not exhibit any definite periodicity in their recurrence in the selected mandi for the papaya. The seasonal price index provides a measure of the month-to-month variation in papaya prices. In respect to price indices, the highest seasonal index was found during the month of July and lowest in month of December which were 109.89 and 89.43 respectively

during the study period., respectively. With respect to arrivals highest indices was in the month of December (170.42) and lowest in July (61.87). The higher seasonal indices of prices were observed during July during which the arrivals were found to be low.

Keywords: Papaya Market power, Concentration ratio (CR) and Herfindahl-Hirschman index (HHI) Prices and arrivals, seasonal, trend, cyclical, irregular

GENETIC DIVERGENCE ANALYSIS IN TARAMIRA (*Eruca sativa* Mill.) UNDER DIFFERENT ENVIRONMENT CONDITIONS WITH SPECIAL REFERENCE TO PRINCIPAL COMPONENT ANALYSIS

MAHAVEER PRASAD OLA AND M. L JAKHAR

Plant Breeding and Genetics, Sri Karan Narendra Agriculture University, Jobner (Jaipur)

ABSTRACT

The field experiment was conducted to identify the principal components among ten morphological and one biochemical (oil content) characters of thirty germplasm lines obtained from all India coordinate research project on oilseeds (Taramira) in a randomized block design (RBD) with three replications in each of the test conditions, which were generated using 3 separate sowing dates with fifteen days interval from October 2nd week to November 3rd week (15th October, 30th October & 15th November 2018-19). First three principal components contributed 76.8% proportion of variation with an eigen value more than one (1.329). The largest percent contribution (30.11) to overall genetic divergence was shown by silique per plant followed by test weight, number of primary & secondary branches per plant & seed yield per plant. The genotypes were divided into nine groups, with cluster II having the most genotypes (12), followed by cluster I with five genotypes. Based on mean value of seed yield, oil content & cluster analysis, eight germplasms with cross combination viz., RTM-1806 X (RTM-314, RTM-1351, RTM-1805, RTM-1810, RTM-1800, RTM-1791, RTM-1815) & RTM-1804 X (RTM-314, RTM-1351) were identified as high yielding which can be widely utilized as a parents in hybridization programme for the development of 9 new diverse varieties/ hybrids for enhanced seed yield as well as oil content.

Keywords: Cluster, Components and Yield

CLIMATE CHANGE MANAGEMENT IN RURAL LIVELIHOOD OF INDIA

GYAN PRAKASH MORYA

Department of Entomology, C.C.S.P.G. College, Bardari, Barabanki, U.P., India

ABSTRACT

The livelihood of the rural people is directly dependent on climate sensitive natural resources. It is endowed with varied climates supporting rich biodiversity and highly diverse ecology. More than 60% of its population living in rural areas, where agriculture is the major concern rural economy that is the backbone of the Indian economy. The impact of climate change on these natural resources affects the agriculture, forests, water resources and human health. The consistent impact of climate change may threaten livelihood activities, which are mostly based on agriculture providing food security. Climate change and global warming pose a significant threat to agriculture. Pest populations are strongly dependent upon temperature and humidity. It has been predicted that 10-40% losses in crop production in India with an increase in temperature 3 to 5°C by the end of 21 century. The allied sectors of agriculture have also been affected adversely by climate change e.g., lowering production in dairy cattle, poultry and fishery. The loss in net revenue at the farm level is estimated to range between 9% to 25% for

a temperature rise of 2°C to 3.5°C. The adaptation, mitigation and natural resource management are basic components of remedial measures taken to combat the adverse impact of climate change. To minimize the adverse impact of climate change, adaptation comprises shifting the population living close to the sea side to escape the rising sea level or promote crops that can tolerate higher temperatures and mitigation comprises measures to reduce the emissions of greenhouse gases by switching to renewable sources of energy.

To combat the adverse impact of climate change on agriculture, its urgent need to adopt climate resilient strategies and initiatives for agriculture in India. The National Action Plan on Climate Change (NAPCC), National Mission for Sustainable Agriculture (NMSA) and National Innovations in Climate Resilient Agriculture (NICRA) are major initiatives for climate resilient agriculture in India. This paper was attempted to review the approaches of climate change management for rural livelihood in India.

Keywords: Climate change management, Climate resilient agriculture, Rural livelihood, India.

EFFECT OF ROCK PHOSPHATE, POULTRY MANURE AND PHOSPHATE SOLUBILIZING BACTERIA ON YIELD OF CHICKPEA

DESHRAJ MEENA, R.H. MEENA, AJIT KUMAR MEENA, KRITI SHARMA

Department of Soil Science and Agricultural Chemistry, Rajasthan College of Agriculture
Maharana Pratap University of Agriculture and Technology, Udaipur, 313001, Rajasthan

ABSTRACT

A field experiment was conducted to study the rock phosphate, poultry manure and phosphate solubilizing bacteria on the availability of phosphorus and yield of chickpea at instructional farm, Rajasthan College of Agriculture, MPUAT, Udaipur during by 2021-22. The experiment was laid out in randomized block design with three replications. The experiment comprises 9 treatments *viz.*, T₁: Control, T₂: PSB, T₃: 100% P through SSP, T₄: 100% P through RP, T₅: 100% P through PM, T₆: 50% P through RP + 50% P through PM, T₇: 100% P through RP + PSB, T₈: 100% P through PM+PSB and T₉: 50% P through RP + 50% P through PM+ PSB. The results showed that application of 50% P through RP + 50% P through PM + PSB (T₉) significantly improved seed and stover yield. However, it did not significantly different from the treatments T₆ (50% P through RP+ 50% P through PM), T₈(50% P through PM+ PSB). The best economic grain yield (2056 kg ha⁻¹) and stover yield (3113.00 kg ha⁻¹) were observed under application of 50% P through RP + 50% P through PM + PSB (T₉).

VEGETABLE GARDEN FOR SEED PRODUCTION

GAJENDRA CHAWLA, KULDEEP HARIYANA

Department of Horticulture, Rajasthan College of Agriculture, MPUAT, Udaipur (Raj.)

ABSTRACT

Annual seed requirement of major vegetables in India is around 51,000 tonnes. Major share of requirement is met with home saved seeds of farmers. With advancement of technologies, especially development of improved varieties and hybrids, seed production has become a specialized job requiring great expertise. Vegetables for seed production are grown in idea soil, climate and disease-free conditions. Each crop / variety is grown in specified isolation distance meeting all the field and crop standards. Timely inspection and rouging are also done to maintain seed purity. Handling of seed crop curing, threshing, cleaning, package and storage are specialized jobs requiring thorough knowledge. Since pests and diseases affect seed field

more than that of vegetable field, timely crop protection measures are to be taken, especially for control of seed borne diseases.

Keywords: Seed Production, Seed purity, Seed Quality etc.

THE ROLE OF LIVESTOCK IN INDIA'S ECONOMIC DEVELOPMENT

KESHARAM MEENA AND BHAVYA PAL

Department of Animal Production, RCA, MPUAT, Udaipur (Rajasthan)

ABSTRACT

Livestock plays an important role in the growth and development of the Indian economy. Livestock has always been considered important to support and improve the health of farmers and to provide additional and stable income throughout the year. The livestock industry offers a unique career opportunity for entrepreneurs. Today, India is the world's largest producer of milk, and dairy cows provide farmers with a steady income from milk sales and interest. Livestock has long been viewed as a mobile bank, as it can be disposed of in emergencies and financial problems. The rapid growth in livestock production has created employment for women and youth. Integrated agriculture is sustainable and by doing different things at the same time increases farmers' incomes and recycling waste products lowers the cost of all agricultural expenditures. Animal foods such as milk, meat and eggs are the main source of animal protein and variations are very rare. With the increase in income and urbanization, food consumption patterns have changed in both urban and rural areas and livestock consumption has changed a lot. Increasing the productivity of farm animals is one of the main problems, because animals provide favorable benefits to food, improving nutrition and health, generating income and employment, and facilitating foreign exchange through exports.

KITCHEN GARDEN OR NUTRITION GARDEN

KULDEEP HARIYANA, GAJENDRA CHAWLA

Department of Horticulture, Rajasthan College of Agriculture, MPUAT, Udaipur (Raj.)

ABSTRACT

Kitchen garden or home garden or nutrition garden is primarily intended for continuous supply of fresh vegetables for family use. A number of vegetables are grown in available land for getting a variety of vegetables. Family members do most of works. Area of garden, lay out, crops selected etc. depend on availability and nature of land. In rural area, land will not be a limiting factor and scientifically laid out garden can be established. In urban areas, land is a limiting factor and very often crops are raised in limited available area or in terraces of buildings. Cultivation of crops in pots or in cement bags is also feasible in cities. The unique advantages of a kitchen garden or home garden are : Supply fresh fruits and vegetables high in nutritive value. Supply fruits and vegetables free from toxic chemicals. Help to save expenditure on purchase of vegetables and economize therapy. Induces children on awareness of dignity of labour. Vegetables harvested from home garden taste better than those purchased from market.

Keywords: Kitchen Garden, Vegetables, Fruit, Land etc.

CHANGES IN LAND USE PATTERN AND AGRI-HORTI PRODUCTION OF FARMERS THROUGH THE TRANSFERRED TECHNOLOGIES UNDER VILLAGE ADOPTION PROGRAMME OF MPUAT, UDAIPUR

***NITESH KUMAR TANWAR, **RAJEEV BAIRATHI, ***S. S. SISODIA**

*Department of Extension Education, Rajasthan College of Agriculture, Udaipur.

**Directorate of Extension Education, MPUAT, Udaipur.

***Department of Extension Education, Rajasthan College of Agriculture, Udaipur.

ABSTRACT

The Village Adoption Programme (VAP) aims to improve the productivity of important crops of the village by dissemination technologies recommended by the scientists of the University and to bring socio-economic development by way of involving the village communities as a whole. Conveying technologies developed by the university and by collaboration with line departments, NGOs, Corporate houses etc. and developing the villages as Smart or Model villages. The present study was conducted in adopted villages by MPUAT, Udaipur. For the selection of beneficiary farmers, all three adopted villages that are Chhali, Undithal and Kerachavas were selected and for the non-beneficiary farmers, the other three non-adopted villages that are Mada, Malariya kalan and Vejaji ka bas were selected for the present investigation. 30 beneficiary farmers from each adopted village and 30 non-beneficiary farmers from each non-adopted village were selected randomly. Thus, a total of 180 farmers were selected for the study. The data was collected by structured schedule and data analyzed by using appropriate statistical methods viz; Z test. The finding of study revealed that changes in Land use pattern (5.559**) and Agri-Horti production (4.499**) of farmers were found significant. These aspects had shown changes after adoption of transferred technologies. The probable reason for change in Land use pattern might be due to use of integrated farming system and changes in Agri-Horti production might be due to adoption of high-yielding varieties.

Keywords: Village Adoption Programme, Technology, Smart village, Beneficiary, Village development.

ROLE OF PLANT ROOT METABOLITES AS NEMATODE ATTRACTANTS, REPELLENTS AND HATCHING STIMULANTS

BASANT DESHWAL

Department of Nematology, IARI, Pusa, New Delhi-110012

ABSTRACT

Management of plant-parasitic nematodes is achieved through crop rotation, cultural practices, use of resistant varieties and chemical nematicides. The chemicals nematicides are costly and many have been banned or are being phased out in parts of the world because of environmental and human health concerns. Therefore, we need to focus on sustainable alternatives for pest management. The biologically active compounds in plant root exudates are reported to act as signalling molecules, attractants, stimulants and also as inhibitors or repellents (Sikder and Vestergard, 2020). A considerable number of bioactive root compounds are documented to have effects on the behaviour, development or even survival of plant-parasitic nematodes (Kud *et al.*, 2021). However, the effects observed in vitro can be altered in soil due to the physicochemical complexity of soil systems. Selection of cultivars that produce high levels of nematicidal or repellent metabolites can be utilised for grafting and breeding nematode-resistant cultivars. Within the last five years, the first studies to establish how root chemicals

regulate genetic expression in plant parasitic nematodes have been published (Bell *et al.*, 2019). Further disclosures of nematode molecular responses to specific root metabolites, and an in-depth understanding of their modes of action will help us predict which compounds hold the largest potential for efficient control or management of plant parasitic nematodes. Besides, studies need to be carried out to observe the effect of these compounds on non-target organisms.

ASSESSING THE EFFICACY OF INSECTICIDAL SPRAY SCHEDULES FOR WHITEFLY CONTROL ON CHILLI (*Capsicum annuum* L.)

LAXMAN SINGH SAINI^{*1} AND MANGAL SUKHI MEENA²

¹Department of Entomology, SKNAU, Jobner, Rajasthan, INDIA

²Department of Entomology, MPUAT, Udaipur, Rajasthan, INDIA

ABSTRACT

The investigation evaluates and validate the bio-efficacy of selected insecticides against whitefly on chilli (*Capsicum annuum* L.). This study revealed that, among the treatments tested, the combination of insecticides as per spray schedule treatment T₁ (Acetamiprid 20 SP @ 100 g/ha + Ethion 50 EC @ 1500 ml/ha followed by Imidacloprid 17.8 SL @ 125 ml/ha + Propargite 57 EC @ 1500 ml/ha followed by Buprofezin 25 SC @ 300 ml/ha + Fenazaquine 10 EC @ 1250 ml/ha followed by Fipronil 5 SC @ 1000 ml/ha + Spiromesifen 240 SC @ 400 ml/ha followed by Chlorantraniliprole 18.5 SC @ 150 ml/ha) was found significantly most effective against whitefly population up to 15 days after treatment with low population 1.77 whitefly/3 leaves.

Key words: Chilli, Bio-efficacy, Sucking insect pests, Insecticides, Population

SEASONAL INCIDENCE OF BIHAR HAIRY CATERPILLAR (*SPILOSOMA OBLIQUA* WALKER) INFESTING SOYBEAN VARIETY JS 97-52

^{1*}MANGAL SUKHI MEENA, ^{2*}LAXMAN SINGH SAINI

¹Department of Entomology, MPUAT, Udaipur, Rajasthan, INDIA

²Department of Entomology, SKNAU, Jobner, Rajasthan, INDIA

ABSTRACT

The bihar hairy caterpillar larval population on soybean cultivar JS 97-52 first time appeared in 33rd SMW (14 August) and there after larval population gradually increased and reached it's peak in the 34th SMW (21 august) with 2.55 larvae/mrl, respectively in different varieties when average temperature, relative humidity and rainfall was 28.2 °C, 74.8 per cent and 30.0 mm, respectively. After 34th SMW larval population decreased but remained active up to 39th SMW. Correlation of bihar hairy caterpillar larval population with weather parameters showed positive correlation with average temperature and relative humidity while, rainfall was negatively correlated.

DTPA – EXTRACTABLE MICRONUTRIENTS STATUS OF THE SOILS UNDER PADDY - POTATO CROPPING SYSTEM OF MEERUT DISTRICT OF UTTAR PRADESH, INDIA

SHIVAM SINGH¹, SATENDRA KUMAR¹, B. P. DHYANI¹ AND U. P. SHAHI¹

Department of Soil Science and Agricultural Chemistry, Sardar Vallabhbhai Patel University of Agriculture and Technology, Meerut

ABSTRACT

The goal of the current study was to evaluate the soil fertility of soils in paddy – potato cropping system. The soil samples were collected from farmer's fields at three depths: 0-15 cm, 15-30 cm, and 30-45 cm. Results showed that the soils were neutral to slightly alkaline in soil reaction, non-saline in salt content, and sandy clay loam to clay loam in texture. Mean values of CEC 17.63, 14.33 and 12.49 C mol (p⁺) kg⁻¹ and Soil organic carbon 2.49, 2.88 and 1.80 g kg⁻¹, DTPA Zn 0.22, 0.36 and 0.49 mg kg⁻¹, DTPA Fe 5.80, 7.39 and 9.73 mg kg⁻¹, DTPA Mn 5.5, 7.38 and 8.64 mg kg⁻¹ and DTPA Cu 0.85, 1.02 and 1.26 mg kg⁻¹ were recorded at 0-15cm, 15-30 cm and 30-45cm, respectively. Soils in this cropping system are deficient in available zinc while sufficient in available iron, manganese, and copper content.

Keywords: DTPA – Zinc, Mn, Fe and Cu.

PROMISING ARRANGED IMPACTS OF ASHWAGANDHA ON BROILER EXECUTION AND CARCASS CHARACTERISTICS: A COMPREHENSIVE REVIEW

BHAVYA PAL AND KESHARAM MEENA

Department of Animal Production, Rajasthan College of Agriculture, MPUAT, Udaipur (Raj.)

ABSTRACT

Poultry production contributes significantly to closing the world's food deficit. Many countries prohibit the use of antibiotics as growth promoters due to increased disease/resistance to antibiotics and the presence of antibiotics in the bird's tissues. That's why the world is turning to other ways to improve bird production and prevent disease. Ashwagandha is commonly known as winter cherry, *Withania somnifera* is abundant in many countries around the world and is considered a potent herbal medicine due to its special chemical, chemical, biological and physiological properties. The plant has antioxidant, cardioprotective, immunomodulatory, antiaging, neuroprotective, antidiabetic, antibacterial, antistress, antitumor, hepatoprotective and growth promoting activities. In chickens, the addition of lily juice to feed has been shown to improve feed intake, weight gain, feed quality and conversion rate, as well as reduce mortality, increase survival, improve disease, reduce stress, and protect chicken health. In this review, the distribution, chemical structure and biological effects of *W. somnifera* and its effects on chicken production, survival, physiological characteristics, good meat, bad blood, immunity and economic activity are presented.

Keywords: Ashwagandha, Antioxidant, Immunomodulatory, Cardioprotective and Antidiabetic

EFFECT OF WEED MANAGEMENT ON NUTRIENT CONTENT AND UPTAKE OF LENTIL (*Lens culinaris* Medik. L.).

SATYA NARAYAN GURJAR,

Department of Agronomy, Rajasthan College of Agriculture, MPUAT, Udaipur (Raj.)

ABSTRACT

A field experiment entitled “Effect of Weed Management on nutrient content and uptake of Lentil (*Lens culinaris* Medik. L.)” was conducted during *rabi* 2021-22 at the Instructional Farm of Agronomy, Rajasthan College of Agriculture, MPUAT, Udaipur. The experiment consisted of twenty treatments combinations *i.e.*, two levels of weeding (control, hoeing at 20 DAS and weeding at 40 DAS) and ten weed management chemicals *viz.*, Pendimethalin 500 g ha⁻¹, Pendimethalin 750 g ha⁻¹, Pendimethalin 1000 g ha⁻¹, Imazethapyr 50 g ha⁻¹, Imazethapyr 60 g ha⁻¹, Imazethapyr 70 g ha⁻¹, Pendimethalin + Imazethapyr 500 g ha⁻¹, Pendimethalin + Imazethapyr 750 g ha⁻¹, Pendimethalin + Imazethapyr 1000 g ha⁻¹, and Control. These were replicated thrice in Factorial randomized Block Design (FRBD).

Keywords- Lentil, weed management, pendimethalin, imazethapyr

SUITABILITY AND GROWTH PERFORMANCE OF *Labeo calbasu* (Hamilton, 1822) IN CARP POLYCULTURE SYSTEM AT MID HILL AREAS OF ARUNACHAL PRADESH, N.E.R INDIA

V.K. MISRA

K.V.K West Kameng, Dirang Arunachal Pradesh

ABSTRACT

The carp polyculture in India plays a major role in culture fisheries system by contributing about more than 80% of their share with three Indian major carps (*Labeo rohita*, *Catla catla*, *Cirrhinus mrigala*) and three exotic carps (*Hypophthalmichthys molitrix*, *Ctenopharyngodon idella*, and *Cyprinus carpio*) with varying level of management, investment and productivity. However, our country is blessed with a large number of other fish species that have very good potential for domestic and export market besides their hardy nature to cope up with various diseases which may occurs during adverse environmental conditions. The culture potentiality of many of these indigenous species has remained unexplored and various ecological, socio-economic and disease problems are increasing day by day because of the introduction of several alien species in our aquaculture system. In view of the above it is high time to pay emphasis to screen out the diversified indigenous candidates with high market value and aquaculture potential to meet the needs of hours. Keeping in mind of the above facts the present study were undertaken in the three locations coming under mid hill areas *i.e.* Dirang, Chug and Changpa of Dirang block during the year 2015-17 under West Kameng district lying approximately between 91° 30' to 92°40' East longitudes and 26° 54' to 28° 01' North latitudes, with the varying elevation ranging about from 300-4200 meter and covering about 7422 Sq.KM of geographical region accounting for 8.86% of the total area of the state Arunachal Pradesh. An important indigenous fish species *i.e.* *Labeo calbasu* (Hamilton, 1822), were introduced as a new species in carp polyculture system for the study on growth performance and their suitability for culture in mid hill areas of the district West Kameng. During the experimental period the observations were made periodically on monthly basis by recording average length and weight of fishes for the monitoring of growth performance of the said species in comparison to other species of carp polyculture system. The encouraging results were recorded in comparison to other fish species of polyculture system especially with reference to common carp. The result clearly indicates that *L. calbasu* is compatible to other component species in composite carp culture system and its inclusion will enhance the economic viability of the system.

Keywords: *Labeo calbasu*, polyculture, monoculture, compatibility, composite carp culture

ICT APPLICATIONS IN AGRICULTURE MARKETING

VIKASH KUMAR MEENA

ABSTRACT

India is one of the major agrarian economies of the world, which is the principal source of livelihood for more than 50% of the population of India. Agriculture is the largest livelihood provider in rural India. In spite of this, the small farmers gains are not enough compared to the efforts put in and agriculture cost inputs; this can affect the agricultural productivity and food security of the nation. In the agriculture sector, constant application of latest ideas and better technologies is essential to enhance economic wellbeing of the farmer. It is demographically the broadest economic sector and plays a significant role in overall socio-economic fabric of India. Agriculture is the backbone of rural households as majority earns their bread from agriculture. But the contribution of agriculture to the economy as well as the economic condition of the farmers is not what they should have been in this era of technology. Indian agricultural system regularly encounters with a number of shortcomings which put significant impact on distribution. Five main trends have been the key drivers of the use of ICT in agriculture, particularly for poor producers: (1) low-cost and pervasive connectivity, (2) adaptable and more affordable tools, (3) advances in data storage and exchange, (4) innovative business models and partnerships, and (5) the democratization of information, including the open access movement and social media. These drivers are expected to continue shaping the prospects for using ICT effectively in developing country agriculture.

Keywords: ICTs, Agriculture, Productivity, Economy, social media.

EFFECT OF CONSERVATION TILLAGE AND *IN-SITU* GREEN MANURING ON SOIL MICROBIAL POPULATION

DEVAPPA¹, RAJASHEKARAPPA, K. S¹, DEVARAJ, K², LATHA, H. S²

¹Department of Soil and Water Engineering, College of Agricultural Engineering, UAS, GKVK, Bengaluru-560065, Karnataka, India

²AICRP for Dry land, Agriculture, UAS, GKVK, Bengaluru-560065, Karnataka, India

ABSTRACT

A field experiment was conducted during *Kharif* 2021 at AICRP for Dryland Agriculture, UAS, Bangalore to know conservation tillage effect on soil nutrient status with pigeonpea as test crop. The experiment was laid out in split plot design with three each main plots on different conservation tillage and sub plots of *in-situ* green manuring practices replicated thrice. Different conservation tillage practices and *in-situ* green manuring crops have caused significant variation on population of bacteria, fungi, actinomycetes status of soil after harvest of the pigeon pea crop. Among different conservation tillage practices, zero tillage (M₃) has recorded significantly maximum population of bacteria, fungi and actinomycetes in soil (21.03×10^6 , 18.26×10^3 and 8.38×10^3 CFU g⁻¹ of soil, respectively) as compared conventional tillage (M₁) (14.42×10^6 , 11.47×10^3 and 5.71×10^3 CFU g⁻¹ of soil, respectively). The microbial population observed among tillage practices was in the order of M₃ > M₂ > M₁. Whereas, lower soil microbial population under conventional tillage was due to excessive ploughing operations, sequent intercultural operations caused greater soil disturbance, lower soil moisture content under dry spells and faster decomposition organic matter resulted in the unfavourable condition for their survival. Horsegram *in-situ* manuring (C₃) has recorded significantly higher population of bacteria, fungi and actinomycetes status in soil (22.71×10^6 , 18.48×10^3 and 8.95×10^3 CFU g⁻¹ of soil, respectively) followed by Sunhemp (C₂) (19.78×10^6 , 14.25×10^3 and 6.86×10^3 CFU g⁻¹ of soil, respectively) as compared to their respective control (C₁). The treatments interaction effect was found non-significant differences. Overall, Zero tillage with Horsegram in situ green manuring has positive impact on crop favourable microbial population.

Keywords: Tillage, Bacteria, Fungi, Actinomycetes, Zero tillage, Horse gram