

3rd International Conference
Global Initiatives in Agricultural, Forestry and Applied Sciences
(Theme: Food Security, Environmental Safety and Sustainable Development)

Souvenir Cum Abstracts/ Proceedings Book

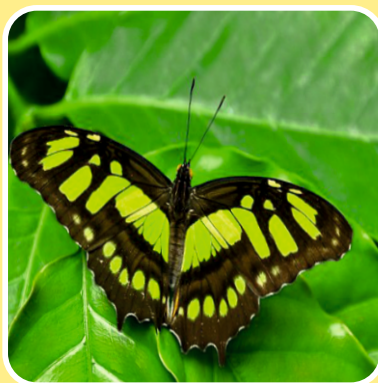

Volume 1



Editors :

■ Dr. Wajid Hasan	■ Dr. C. P. Singh	■ Dr. A.K. Srivastava	■ Dr. U. S. Rawat
■ Dr. Sanjay Swami	■ Dr. Moinuddin	■ Dr. Arvind Kumar	■ Dr. Jameel Akhtar
■ Dr. Md.Minnatullah	■ Mr. Kota Chakrapani	■ Dr. Hrikesh Singh	■ Dr. Huma Naz



October 17-18, 2021

E-Mail: gifas2021@gmail.com, **Website:** www.agetds.com

Global Initiative in Agricultural, Forestry and Applied Sciences
(Food Security, Environmental Safety and Sustainable Development)

Editors:

Dr. Wajid Hasan
Dr. C.P. Singh
Dr. A.K. Srivastava
Dr. U.S. Rawat
Dr. Sanjay Swami
Dr. Moinuddin
Dr. Arvind Kumar
Dr. Jameel Akhtar
Mr. Kota Chakrapani
Dr. Harikesh Singh
Dr. Huma Naz

First Edition 2021

Copyright © Authors

All right reserved.

ISBN: 978-93-5419-016-2

No part of this book shall be reproduced or transmitted in any form or by any means, electronic or mechanical, including photocopying, or by any information storage and retrieval system without permission of the publisher.

DISCLAIMER

The authors are solely responsible for the contents of the papers compiled in this volume. The editors or publisher do not take any, responsibility for same in any manner. Errors, if any are purely unintentional and readers are requested to communicate such errors to the editors or publisher to avoid discrepancies in future.

Published by: Self Published

E-Publication

Website: www.agetds.com, e-mail: entowajid@gmail.com

“Quest for Excellence”



SHRI GURU RAM RAI UNIVERSITY
(Established under Shri Guru Ram Rai University
Act. No. 03 of 2017)

Message

I am happy to learn that the 3rd International Conference on Global Initiatives in Agricultural, Forestry and Applied Sciences (GIAFAS-2021) with the theme of Food Security, Environmental Safety and Sustainable Development is being organized by the Agricultural and Environmental Technology Development Society (AETDS), U. S. Nagar, U.K., India at Shri Guru Ram Rai University, Dehradun w.e.f. October 17-18, 2021. The conference will take an in-depth look at many issues about the obstacles and opportunities induced by the changing Global climatic scenario. This conference is a step towards achieving our vision in becoming a world-class academic and research institution in order to produce human capital with excellent state of mind.

Dehradun is a beautiful city and one of the most notable academic and research destinations of India where learning is promoted in the best possible way and carries the label of “School Capital of India”, thus it is known also as India’s education hub. Shri Guru Ram Rai School of Agricultural sciences, Dehradun is a prime centre of teaching and learning for those candidates who want to frame their career in mega agriculture sector of the world. The School focuses on synergizing multi-disciplinary education and strengthening problem specific research relevant to the state which helps building innovative set-up.

I am confident that this occasion will be able to provide a platform towards strengthening our relationships in knowledge sharing while at the same time provide the necessary thrust in joint research collaborations and product commercialization within the research society. I hope that this conference will be a foundation for the growth of new ideas towards a better tomorrow. I would like to thank AETDS, US Nagar, U.K., India for choosing SGRR University as venue of this conference and wish a grand success of this conference.

Shri Mahant Devendra Dass

Chancellor

Shri Guru Ram Rai University



Ref: AETDS/ SO/201

Date: 15.10.2021

Dr. C.P. Singh

President



MESSAGE

It's a matter of great pleasure that the Agricultural & Environmental Technology Development Society (AETDS), U.S. Nagar, UK, India organizing **3rd International Conference on "Global Initiative in Agricultural, Forestry and Applied Sciences for Food Security, Environmental Safety and Sustainable Development (GIAFAS-2021)"**, with the collaboration with Shri Guru Ram Rai University, Dehradun, Uttarakhand, India; Department of Agronomy, Sher-e-Bangla Agricultural University, Dhaka, Bangladesh; Soil and Water Research Institute (SWRI), Karaj, Iran; Department of Soil Science, Faculty of Agro-Based Industry, UMK, Malaysia; College of Horticulture and Gardening, Yangtze University, P.R. China and Corteva agriscience at Shri Guru Ram Rai University, Dehradun, Uttarakhand, India on October 17-18, 2021.

In this context, emphasis will be on novel tools and technologies in the field of Agricultural and Allied Science, Medical Science, Social Sciences, Biological, and Physical Sciences. This conference will bring together the global scientific community, policymakers, administrators, industry representatives, and other stakeholders to exchange and share their experiences, new ideas. It will be an opportunity of sharing our expertise and experience with renowned speakers from all over the world. It will also be a platform to strengthen the friendship and collaboration among the scientists, academia, and the institutes. The various subthemes of the conference will offer many opportunities to delegate to learn new things and apply the same in their respective workplace.

I want the conference associate eminent accomplishment in achieving its goal towards food security, environmental safety and property development therefore enlightening international innovative in agricultural, biological science and applied sciences.

(Prof. C. P. Singh)

Conference Director & President AETDS

Former Prof. GBPUAT, Pantnagar

डॉ. प्रदीप कुमार बिसेन
कुलपति

Dr. Pradeep Kumar Bisen
Vice Chancellor



जवाहरलाल नेहरू कृषि विश्वविद्यालय
कृषि नगर, आधारताल, जबलपुर ४८२ ००४ (म.प्र.)
Jawaharlal Nehru Krishi Vishwa Vidyalaya
Krishi Nagar, Adhartal, Jabalpur 482 004 (M.P.)

Message

I am happy to know that Agricultural & Environmental Technology Development Society is organizing a 3rd International Conference on "Global Initiatives in Agricultural, Forestry and Applied Sciences" during October 17 -18, 2021 at Shri Guru Ram Rai University, Dehradun, Uttarakhand, India.

Agriculture is an important component of rural livelihoods. Agriculture scientists play a pivotal role in all agricultural technologies from planting-to-harvesting-to-post-harvest. Tremendous challenges are being put forth by biotic and abiotic stresses before the agricultural scientists to meet the ever-growing demands of food and nutritional security with a climate change scenario. Food Security, Environmental Safety and Sustainable Development are posing a major threat to agricultural crops in several parts of the country. Development of sustainable food security, management strategies offers one of the best options to enhance the crop production and protection, as land water and other natural resources are depleting.

I am confident that interactions among scientists during the conference will provide useful recommendations.

I congratulate Dr. Wajid Hasan, Secretary, AETDS, Society and Prof. C. P Singh, Conference Director and President AETDS, Society, U.S. Nagar, U.K. for taking initiation and leadership.

I extend my heartiest greetings to participants and wish the event the grand success.

(P.K. Bisen)



Professor Dr. Md. Shahidur Rashid Bhuiyan,
Vice-Chancellor, Sher-e-Bangla Agricultural
University, Dhaka-1207
&
Patron: GIAFAS-2021, E-Mail: vc@sau.edu.bd
Cell: +0244814051



Message from Patron

It gives me immense pleasure to know that Agricultural & Environmental Technology Development Society (AETDS), U.S. Nagar, UK, India is going to organize the 3rd International Conference ‘*Global Initiatives in Agricultural, Forestry and Applied Sciences (GIAFAS-2021)*’ in collaboration with Department of Agronomy, Sher-e-Bangla Agricultural University, Dhaka-1207 along with other reputed organizations around the world. The theme for this year conference “*Food Security, Environmental Safety and Sustainable Development*” is of global priority today.

The COVID-19 pandemic is still on-going. During the last couple of years, the world has experienced and realized how whimsical the nature could be at times and how badly the consequences could affect the entire mankind for food, treatment and shelters. As we know this world is still the one and only liveable habitat for human, other animals and plants which is facing tremendous environmental pressures in recent years due to regular advent of natural disasters. Limited agricultural resources and continuous population increase in developing countries ultimately leading to an environmental imbalance thus aggravating the food security issues in coming decades. In addition, under the present pandemic circumstance, farmers and their farming have become more challenging and vulnerable to ensure food and nutritional security. However, to comply with the SDGs’2030 we need to nurture our environmental resources in a sustainable way giving emphasis on sourcing renewable energies. Thus, there is a great need for institutional efforts and peoples’ participation to address issues related to food security, environmental safety, sustainable development and preserving natural resources in general. To do so, the linkages between agricultural and applied sciences are essential. Collective efforts should be made by relevant institutions through ensuring participations of people from all walks.

I am sure that this dual mode (offline and virtual) International Conference will focus on the various scientific tracks covering major areas of research on agriculture, biological and applied sciences and would become a platform for bringing together administrators, business bodies, policy makers and the members of global scientific community including scientists, researchers and distinguished professors to find out the key problems, challenges and pragmatic solutions which will help in in-depth understanding of the global food security and environmental safety issues in a long-lasting way. I do believe that the outcomes of this International Conference will help policy makers to formulate plans and take immediate actions appropriate for ensuring food and nutrition security and agricultural sustainability in the deprived regions of the world.

I would like to appreciate the organizing institutes of this conference and thank the people whose dedicated efforts and creative plans will make the conference successful. Finally, I wish a grand success of the 3rd International Conference going to held at Shri Guru Ram Rai University, Dehradun, U.K., India during 17th to 18th October 2021.

Dated: 10-10-2021



Date : 11.10.21

Message

With immense pleasure and pride, I heartily congratulate the Department of Agriculture of the University for organizing a two-day International Conference *w.e.f.* 17th -18th October, 2021 in collaboration with other organization of national and international repute on Global Initiatives in Agricultural, Forestry and Applied Sciences (GIAFAS-2021) with the premise of Food Security, Environmental Safety and Sustainable Development supported by the Agricultural and Environmental Technology Development Society (AETDS), U. S. Nagar, U.K., India.

In view of the changing Global climate, the theme of the conference chosen by the organizers is need of the hour and highly appreciable. Participants from several institutions around the world meet here to share their research work. The discussions during the conference through the expert-talks and dialogic-exchanges on the challenges of Food Security, Environmental Safety and Sustainable Development under changing climatic conditions are documented as proceeding of the conference. The conference proceeding shall help the policy-makers to shape the policies in the interest of common people and other stakeholders that eventually positively shape our nation and make the citizens future-ready. This conference will also inspire the entire team of the University to persistently undertake such ventures which work for knowledge- enhancement of the society at large.

I am optimistic that this International Conference organized by the Department of Agriculture, Shri Guru Ram Rai University, Dehradun in association with other national and international organization and supported by AETDS, U. S. Nagar, U.K., India will further strengthen and promote collaboration in the Commerce fraternity.

My best wishes for the success of the conference.

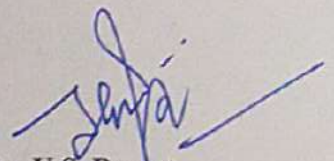
Dr. U.S. Rawat
Vice Chancellor

Amar P. Garg

M.Sc., Ph.D., LL.B., F.B.S., F.P.S.I., F.S.M.P., M.N.A.Sc., F.N.R.S., CAS Fellow (U.K.), DAAD Fellow (Germany)
Distinguished Professor, Dean Research, Director Biotechnology
Sectional President Environmental Science, 108th Indian Science Congress (2020-22)
Former Professor & Head, C.C.S. University, Meerut, Former PVC, JNU, Jaipur, Former Vice Chancellor SIET, Meerut
Email: amarprakashgarg@yahoo.com, deanresearch@shobhituniversity.ac.in
Mob. 8077633273, 9410608377



I am delighted to know that one of the most prominent society of Agricultural education popularly known as AETDS based in Uttarakhand, **India** is organizing *3rd International Conference on “Global Initiative in Agricultural, Forestry and Applied Sciences For Food Security, Environmental Safety and Sustainable Development (GIAFAS-2021)”* at Shri Guru Ram Rai University, Dehradun in collaboration with Sher-e-Bangla Agricultural University, Dhaka, Bangladesh; Soil and Water Research Institute (SWRI), Karaj, Iran; UMK, Malaysia; Yangtze University, P.R. China and Corteva Agriscience, on October 17-18, 2021.

The organizers have very rightly selected the most relevant topic in view of the focus of world economy on agriculture which is the foundation growth and development of any country. The conference will provide an excellent opportunity for active interaction with great International Professors, prominent agriculturalists, food security experts, environmentalists and authorities working in various fields of Life Sciences to discuss various issues related to Agriculture, Forestry, Environment and Allied Sciences. I am confident that the participants will take fullest advantage of this international conference in dual mode and will enjoy the excellent weather of Dehradun.

I wish all success to the organizers.

Dated: 06-10-2021

(Prof. Amar P. Garg)
Dean, Research & Development



Professor Dr. Mirza Hasanuzzaman, Department of
Agronomy, Sher-e-Bangla Agricultural University,
Dhaka-1207

&
Associate Director: GIAFAS-2021

E-Mail: mhzsauag@yahoo.com

Cell: + 8801716587711



Message from Associate Director

I would like to take the opportunity to express my profound joy on the event of the 3rd International Conference ‘*Global Initiatives in Agricultural, Forestry and Applied Sciences* (GIAFAS-2021) jointly organized by the Agricultural & Environmental Technology Development Society (AETDS), U.S. Nagar, UK, India and other widely known organizations at Shri Guru Ram Rai University, Dehradun, U.K., India during 17th and 18th October 2021.

The United Nations sustainable development goals include eradication of hunger from the world by 2030. But the world currently is in need of surplus production of food in order to meet the food demand especially in developing nations where hunger is still one of the major issues. Food security and environmental safety are both key policy goals in the contemporary global arena, but there is no necessary congruity between them. Conflicts and contradictions always pave their ways when actors (global, national or local) seek to achieve both security in food supply and delivery, and sustainability in the use of the natural resources needed to produce food. However, making a hunger free world is a gigantic task that involves many other issues like environmental protection, nutritional safety, reduce deforestation and urbanization that also need to be addressed with prior concern. Therefore, at this juncture, the initiative taken up by the collaborating institutions under the theme ‘*Food Security, Environmental Safety and Sustainable Development*’ for this year conference is of global preference today.

Projected world population by 2050 will reach 10 billion. To feed 10 billion mouths, we need to get the trade-offs right between sustainability, food security, food safety, and make better use of food already produced. Hence, feeding 10 billion people in a sustainable way will probably require disruptive changes of the food supply chains during the next 20 years. Moreover, the reduction of food losses and food waste could be a part of the solution. Equally, the introduction of new socio-technologies in rural areas, for instance for renewable energy generation, driven by environmental interests, may help to undermine the social sustainability of such areas in ways which threaten continued food production.

I hope the deliberations and sharing of the core ideas, experiences, creative imaginations, innovations and formulas of different expertise under different sub-themes will be a milestone for the solutions of ongoing challenging issues of food and environmental security of the world. Indeed, I believe that, such kind of scholarly gatherings could play a vital role in making the world a better place and also make ready to tackle any difficult situations in the near future.

As an Associate Director of the Organizing Committee, I am grateful to the researchers and academicians of national and international level and others who have offered their collaboration by submitting constructive papers and abstracts for this conference.

Finally, I wish the conference an eminent accomplishment in achieving its goal towards food security, environmental safety and sustainable development thus enlightening global innovative in agricultural, forestry and applied sciences.

Dated: 05-10-2021

(Mirza Hasanuzzaman)



**Dr. Sanjay-Swami, Professor (SSAC)
& Organizing Convener: GIAFAS-2021**
School of Natural Resource Management,
College of Post Graduate Studies in
Agricultural Sciences (CPGS-AS)
(Central Agricultural University)
Umiam-793 103 Meghalaya, India
E-Mail: sanjayswamionline@gmail.com
Cell: + 91-94191-57291



MESSAGE

It is indeed a matter of great pride for me in organizing the 3rd International Conference on *Global Initiatives in Agricultural, Forestry and Applied Sciences for Food Security, Environmental Safety and Sustainable Development* (GIAFAS-2021) organized by the Agricultural & Environmental Technology Development Society (AETDS), U.S. Nagar, UK, India and many other reputed organizations at Shri Guru Ram Rai University, Dehradun, U.K., India during 17th to 18th October 2021 in hybrid mode.

Friends, while agriculture can feed the world's population, it is responsible for deforestation globally. Commercial agriculture accounts for about 40 per cent of deforestation in the tropics and sub-tropics, local subsistence agriculture for 33 per cent, infrastructure for 10 per cent, urban expansion for 10 per cent and mining for 7 per cent. Combating climate change and ensuring food security are both extremely important. When we compare the numbers, deforestation or converting forests into agricultural lands contributes more than 10 per cent of greenhouse gas emissions annually, but it only expands the world's agricultural land by around one-tenth of a per cent a year. This means that protecting and restoring forests is critical for stopping climate change, but the big gains in improving food security will happen elsewhere.

The 2030 agenda for sustainable development, as well as the Paris agreement on climate change recognizes that we can no longer look at food security and the management of natural resources separately. There are clear linkages and synergies between agricultural production and sustainable forest management. If the sustainability of the agriculture and forests can be assured, food security, environmental safety and sustainable development would go in long-term perpetuity.

I am confident that this International Conference will deliberate on the issues of food security, environmental safety and sustainable development to ensure triple win through innovative approaches of agricultural, forestry and applied sciences.

I wish the International Conference a grand success.

Dated: 17-10-2021

(Sanjay Swami)



Ref:AETDS/SO/403

Date: 16.10.2021



From the Desk of Chief Organizing Secretary

It is a matter of great privilege for me to organize the **3rd International Conference on “Global Initiative in Agricultural, Forestry and Applied Sciences for Food Security, Environmental Safety and Sustainable Development (GIAFAS-2021)”**. Jointly Organized by the Agricultural & Environmental Technology Development Society (AETDS), U.S. Nagar, Uttarakhand, India; Shri Guru Ram Rai University, Dehradun, Uttarakhand, India; Department of Agronomy, Sher-e-Bangla Agricultural University, Dhaka, Bangladesh; Soil and Water Research Institute (SWRI), Karaj, Iran; Department of Soil Science, Faculty of Agro-Based Industry, UMK, Malaysia; College of Horticulture and Gardening, Yangtze University, P.R. China and Corteva agriscience at Shri Guru Ram Rai University, Dehradun, Uttarakhand, India on October 17-18, 2021.

On behalf of the organizing committee, I warmly welcome all participants, delegates, researchers, scientists, students from different institutions, colleges, and universities from India and abroad.

GIAFAS-2021 has been designed to focus on various scientific tracks covering major areas of research on agriculture, biological, and applied sciences. In this context, emphasis pointed on novel tools and technologies in the field of Agricultural and Allied Science, Medical Science, Social Sciences, and Biological Sciences. This conference will bring together the global scientific community, policymakers, administrators, industry representatives, and other stakeholders to exchange and share their experiences, new ideas. The conference is aimed to provide a common platform to scientists, researchers, academicians, professionals, social workers, policymakers as well as farmers and expertise corporate to exchange their new ideas and recent research findings with colleagues, which will boost their knowledge and experience. In this global event scientists across the world are participating.

The organizing committee has been very active and arrangements are well underway to ensure that **3rd International Conference on “Global Initiative in Agricultural, Forestry and Applied Sciences for Food Security, Environmental Safety and Sustainable Development (GIAFAS-2021)”** is a resounding success. I appeal to the research community to extend their continued support and cooperation to the future activities of AETDS.

I look forward to welcoming you all and pray almighty to bless us for making GIAFAS-2021 a grand success.

(Dr. Wajid Hasan)

Chief Organizing Secretary, GIAFAS-2021

Secretary, AETDS, Society

Email: gifas2021@gmail.com, Mob. 7004942581



Shri Guru Ram Rai University

(Estd. By Govt. of Uttarakhand, vide Shri Guru Ram Rai University Act No. 03 of 2017 Act No. 03 of July 2017)

Dr. Moinuddin

Associate Professor (Agronomy)

School of Agricultural Sciences

Shri Guru Ram Rai University (Quest for Excellence)

Pathri Bagh, Dehradun, Uttarakhand-248001, India



I am gratified to Almighty God, the most gracious and most merciful, for His blessings in giving us this precious opportunity to organize this memorable event. The 3rd International Conference on Global Initiatives in Agricultural, Forestry and Applied Sciences (GIAFAS-2021) with the theme: Food Security, Environmental Safety and Sustainable Development is a wonderful experience of my career. It gives me a great pleasure to welcome you all at 3rd International Conference on Global Initiatives in Agricultural, Forestry and Applied Sciences (GIAFAS-2021) to be held *w.e.f.* 17th -18th October, 2021. Due to the challenging times COVID-19 for last two years, the conference is being organized in a hybrid mode of both off- as well as on-line. The scientific sessions of the conference have been carefully planned that will cover a wide spectrum of topics along with orations, guest lectures, key note addresses, etc. which will cover latest innovations, research and current topics. We propose making this a high tech conference with innovations in registration, entries and audiovisuals.

I would like to thank each of you for attending GIAFAS-2021 and bringing your expertise to this awesome gathering. You, as researcher, have the vision, the knowledge, the resources and the experience to help us pave our way into the future technical activities. Throughout this conference, I request you to stay engaged, keep us proactive and help us bringing out more such events in future. My personal admiration and gratitude goes out to all of you.

I, on behalf of the SGRR University, Dehradun, AETDS, U. S. Nagar and other organizing associates welcome you all for your active and large participation in this conference to make it a grand success.

Dr. Moinuddin
Organizing Secretary

CONTENTS

ABSTRACTS

S. No	TITLES AND AUTHORS	Page No.
1	Determining the nutrients level norms for high yield apple orchards in two main regions of Iran Majid Basirat ^{1,*} , Akbar Gandomkar ² , Farokh Ghani Shayesteh ³ and Seyed Majid Mousavi ¹	1
2	Biochar; A solution to increase nitrogen use efficiency in paddy soils Meysam Cheraghi 1 , Sepideh Bagheri Novair 2	1
3	Importance and functions of biochar in soil and plant health Meysam Cheraghi 1 , Seyed Majid Mousavi 2* , A. K. Srivastava 3	2
4	Comparison of statistical Data-mining techniques in estimating important points of soil water retention curve of Iran soils Arash Taftah 1* , Naser Davatgar 2 , Azadeh Sedaghat 3	2
5	Response of sesame plants to different amounts of nitrogen and timing of application in main regions of Iran Fereydun Nourgholipour 1* , Seyed Majid Musavi 1 , Arash Sabbah 2 , Majid Rajaii 3 , Mohammad Reza Rafii 4 , Mokhtar Zolfi Bavariani 5	3
6	The effect of potassium and calcium foliar application on physico-chemical characteristics of ‘Thomson Navel’ sweet orange during cold storage ¹ Tahereh Raiesi and ² Javad Fatahi Moghadam	4
7	Concept, formation and role of rhizosheath in increasing plant tolerance to water deficit stress and nutrient deficiency Meysam Cheraghi ^{1*} , Seyed Majid Mousavi ² and Babak Motesharezadeh ²	5
8	Estimating important points of soil water retention curve with experimental-physical models Arash Taftah ^{1*} , Naser Davatgar ² , Azadeh Sedaghat ³	5
9	Estimating the soil surface moisture by using spectral indices of Sentinel-2 satellite and Machine learning Azadeh Sedaghat ^{1*} , Mahmoud Shabanpour Shahrestani ¹ , Ali Akbar Nourouzi ² , Alireza Fallah Nosratabad ³ and Hossein Bayat ⁴	6
10	Transcriptomic Analysis Uncovers the Change in Sucrose Metabolism of Fruits in Late-Ripening Sweet Oranges after Foliar Application of EE-GRSP Hui-Hui Wu ¹ , A.K. Srivastava ² , Yan Li ³ , Ying-Ning Zou ¹ , and Qiang-Sheng Wu ¹ *	7
11	Effects of field inoculation with arbuscular mycorrhizal fungi on fruit quality and root physiological activity of citrus Ming-Ao Cao ¹ , A.K. Srivastava ² , Ying-Ning Zou ¹ , and Qiang-Sheng Wu ^{1*}	7
12	Status of Litchi in Bangladesh: Production, Marketing and Postharvest Loss Assessment Sayla Khandoker ¹ , M. A. Rashid ¹ , M. Khatun ¹ and M. S. Hoq ¹	8
13	Breeding innovation for vegetable and forage maize research in Vietnam: The Progress and Future perspective Nguyen Trung Duc ^{1*} , Pham Quang Tuan ¹ , Nguyen Thi Nguyet Anh ¹ , Vu Van Liet ¹ , Nguyen Xuan Thang ²	8
14	Status, opportunities and genetic improvement of minor cereals in Bangladesh Zahirul A. Talukder ^{*1} , A.N.M.S. Karim ¹ , M.M. Rohman ¹ , M.M. Billah ¹ , S.S. Alam ¹ , S.H. Omy ¹ , A.H. Akhi ¹ , M.K. Alam ¹ and M.M. Ali ¹	9
15	VERMIREMEDIATION: AN INNOVATIVE APPROACH FOR CLEANING UP THE CHEMICALLY POLLUTED SOILS	10

	Sanjay-Swami, Thokchom Dorenchand Singh, Shubham Singh and Pritisha Patgiri	
	Sustainable Development and Environment of Biomass from	
16	Agriculture Residues	16
	Abdeen Mustafa Omer	
17	The role of plant growth promoting rhizobacteria in the management of disease complex induced by root knot nematode and fusarium wilt fungus	45
	Zakaullah Khan*, Bharat H. Gawade and V Celia Chalam	
18	Land potentiality evaluation based on GIS modeling technique for Agroforestry uses in the Jharkhand state of India	46
	Firoz Ahmad ^{1*} , Abdul Majid Ansari ² , Firoz Ahmad ³ , Laxmi Goparaju ¹	
19	Morpho-Physiological and Biochemical Performances of Different Sugarbeet Genotypes under Salinity Stress	48
	Abdul Awal Chowdhury Masud ^δ , Naznin Ahmed, Md. Rakib Hossain Raihan, Mirza Hasanuzzaman*	
20	The role of mycorrhiza in food security and challenge with climate change	49
	Dr. İbrahim Ortaş	
21	Protective Role of Biochar and Chitosan Biopolymer in Enhancing Salt Tolerance in <i>Corchorus olitorius</i>	50
	Md. Rakib Hossain Raihan ^δ and Mirza Hasanuzzaman*	
22	Implication of melatonin on photosynthesis, photosystem, fast chlorophyll fluorescence and related gene expression in tomato seedling under high temperature stress	51
	Mohammad Shah Jahan	
23	Knowledge about Sustainable Forest Management Practices of Joint Forest Management Committee Members and Non-members.	52
	Shobha Nagnur and Akshata Ramannanavar*	
24	ENTOMOPATHOGENIC NEMATODES EMERGING AS POTENT BIOCONTROL AGENT AGAINST INSECT PESTS	53
	RASHID PERVEZ	
25	Influence of sowing time and seed rate on the growth and yield of BARI Mung-6	54
	Chaity Dey Puja, A.K.M. Ruhul Amin and Babu Lal Nag	
26	Morpho-Physiological and Biochemical Responses of Napier Grass under Water Stress Conditions	55
	Faria Jannat ^δ , Taufika Islam Anee, Mst. Mahbuba Khatun, Mirza Hasanuzzaman*	
27	Enhancement of Salt Stress Tolerance in <i>Glycine Max</i> by Zinc Priming	56
	Farzana Nowroz ^δ , Md. Rakib Hossain Raihan, Mirza Hasanuzzaman*	
28	Improving Rice Productivity in Cadmium-Contaminated Soil using Azolla: Study on Cadmium Accumulation, Antioxidant Defense and Glyoxalase Pathway	57
	Kamrun Nahar ^{1*} , Mirza Hasanuzzaman ² , Khursheda Parvin ³ , Sayed Mohammad Mohsin ⁴ , Kamal Uddin Ahamed ¹ and Masayuki Fujita ^{5*}	
29	Vanillic Acid Pretreatment-induced Modulation of Physiology, Antioxidant Defense and Glyoxalase Systems to Improve Drought Tolerance of Tomato	58
	Khursheda Parvin ¹ , Mirza Hasanuzzaman ^{2*} , Sayed Mohammad Mohsin ^{3,4} , Kamrun Nahar ⁵ and Masayuki Fujita ⁴	
30	Insight into the Mechanisms of Salt and Drought Tolerance in <i>Chenopodium album</i>	59
	Khussboo Rahman ^δ , Mira Rahman and Mirza Hasanuzzaman*	
	Department of Agronomy, Sher-e-Bangla Agricultural University, Dhaka-1207, Bangladesh	

31	Role of Different Organic Amendments in Mitigating Drought Stress-Induced Oxidative Stress in <i>Triticum aestivum</i> Taufika Islam Anee ^δ , Md. Nur Nabi Islam, Abdul Awal Chowdhury Masud, Mahabub Alam, Mirza Hasanuzzaman*	60
32	Morpho-phenetical diversity of white jute cultivars in Bangladesh M.M. Mukul*, M.H. Rashid, N. Akter	61
33	Determination of LD ₅₀ for Chemical (EMS) Mutation in White Jute (<i>Corchorus capsularis</i> L.) under laboratory condition MM Mukul*, MH Rashid, SSU Ahmed, M Al-Mamun, MM Islam, SA Jui, IJ Nur, SK Biswas, MG Mostofa, N Akter	61
34	Fixation of Lethal Dose 50 (LD ₅₀) for Ethyl Methane Sulphonate (EMS) Mutation in Tossa Jute (<i>Corchorus olitorius</i> L.) under laboratory condition MM Mukul*, SSU Ahmed, MM Islam, N Akter, MG Mostofa	62
35	Evaluation of Different Millet Based Inter Cropping Systems under Organic Farming in Northern Transitional Zone of Karnataka R. Basavarajappa	63
36	Effect of Different Inorganic, Organic and Bio-Fertilizers on Plant Growth of Sweet Orange (<i>Citrus sinensis</i> Osbeck.) Johnson Lakra ^{1*} , Muktilata Tirkey ² , Ravina Pawar ¹ and Panma Yankit ¹	63
37	Effect of silicon application on growth and yield attributes on rice (<i>Oryza sativa</i> L.) under normal and water stress condition Thi Thi Myint (Myanmar)	64
38	Seroprevalence of brucellosis in raw milk sample in Jaipur city Raghavendra Prasad Mishra*, Rizwan Khan, A. Bhattacharya	64
39	An improvement in biochemical properties of curd in sprouting broccoli [<i>Brassica oleracea</i> (L.) Plenck var. <i>italica</i>] by micronutrients and organics Manju Netwal ^{1*} , M R Choudhary ¹ , O P Garhwal ² and S P Singh ¹	64
40	Race specific adult plant resistance test against selective prevalent stem rust pathotypes under glasshouse condition V. M. Sali *, M. A. Sushir. D. S. Kadam, M. A. Gud and D. P. Deshmukh	65
41	Seedling resistant test of wheat genotypes against selective pathotypes of stem and leaf rusts under glass house condition M. A. Sushir*, D.S. Kadam, V. M. Sali, M. A. Gud and D.P. Deshmukh	65
42	<i>In vitro</i> antifungal activity of essential oils against <i>Rhizoctonia solani</i> causing sheath blight of rice Udaykumar Thera*, Ashmita Timsina	65
43	The wisdom for dual role of rural women in household and papad making enterprise for their livelihood in Bihar state Rambha Kumari ¹ and Shishir Kala ²	66
44	Exfoliative vaginal cytology and hormonal profile of malabari crossbred does during the oestrus cycle Upasana Ratnakaran ^{*1} , Aravinda Ghosh ¹ , K.N., Metilda Joseph ¹ , Hiron, M. Harshan ¹ , R. Thirupathy Venkatachalapathy ² and V. Ramnath ³	67
45	Impact of climate change on Agriculture and its mitigation strategies: A Review Mehnaz Aijaz and Eyram Hamid	67
46	Design and development of farmer’s participatory newsletter on honey production in Nainital district of Uttarakhand Aafreen Malik and Amardeep	68
47	Genebank Genomics Chaw Su Su Htwe	68
48	Survey report on crop losses due to late blight disease in potato	69

	Ekta Pandey ¹ and Medha Pandey ²	
49	Characterization of efficient biosurfactant producing bacterial isolates from the Yamuna River sediments Zarreena Siddiqui and Abdul Malik	69
50	Studies on the variation in quality traits of pickle prepared from aonla (<i>Emblica officinalis</i> Gaertn.) cultivars and their suitability for pickle preparation Rajendra Kumar*	70
51	A slippery model of sweet corn output and growth Medha Pandey ¹ and Ekta Pandey ²	70
52	Recent advancements for energy production and sustainable environment in anaerobic digestion technology P. S. Bandgar, Sudhir Jain and N. L. Panwar	71
53	Elucidating the effect of Farmyard Manure and Zinc along with optimum dose of inorganic fertilizer on the productivity of rice (<i>Oryza sativa</i> L.) Neelam Pankaj	71
54	Genetics and Epigenetics- role in development of Climate resilient crops Piyusha Singh ¹ , Akanksha Tiwari ¹ , Vimlesh Kumar ² and Alok Kumar Singh ³	72
55	Effect of fertilizer on growth and yield of bamboo (<i>Bambusa balcooa</i>) under rain fed condition Aarti P Deshmukh, V. M. Ilorkar and P.D.Raut	72
56	Production Potential of agricultural crops under citrus based Agroforestry systems in semi-arid region of Maharashtra. Aarti P Deshmukh ¹ , Lalji Singh, V. M. Ilorkar and P.D.Raut	72
57	Impact of zinc and boron in shelf life of vegetable crops (onion and tomato) Tariq Ahmad Bhat ^{1*} , A.M. Rather ² and F.Mushtaq ²	73
58	Development and recent trends in IoT based food drying system: An overview Nikita Mishra ^{1*} , Ashok Kumar ¹ , S.K. Jain ² , N.K. Jain ² , N. Agrawal ³	73
59	Synthesis and characterization of surfactant (CTAB/TSC/TX-100) assisted Ir & Sn mono/ bimetallic nanoparticles and their application Anjali Goel, Sudha Tomar*	74
60	Synthesis, characterization, and effect of cationic, anionic, and nonionic stabilizers on the particle size of Ir-Ni bimetallic nanocrystals Anjali Goel and Shikha*	74
61	Impact of Climate Change on Migration Minakshi Chakraborty	75
62	Trees as Sound Barriers Dipali Chatse*, Dipmala Kedar, Ramakant Gajbhiye	76
63	Traditional agricultural knowledge of tribes and resource based nutrient management interventions for the tribal farmlands of Madhya Pradesh *Shinogi K.C., Sanjay Srivastava, Priya Gurav, Nishant Kumar Sinha, Bharat Prakash Meena, K. Bharati, Rameshwar Prasad Ahirwar, Hiranmoy Das and A.K Tripathi	76
64	Acute toxicity of Silica oxide nanoparticles on Indian Major carp <i>Labeo rohita</i> fingerlings Ujjwala Upreti and Avdhesh Kumar	77
65	Development and Assessment of Small Scale Mechanized Groundnut Decorticator Geeta Chitagubbi, Rajeshwari Desai and Shobha Kasar	77
66	An interventional analysis on drudgery reduction technologies for empowerment of farm women Geeta Chitagubbi, Rajeshwari Desai and Shobha Kasar	78

67	Performance of maize (<i>Zea mays</i>) as influenced by drip irrigation schedules and nitrogen levels Y. Deepthi Kiran, V. Sumathi and G. Prabhakara Reddy	78
68	Molecular identification and characterization of <i>Banana bunchy top virus</i> from Uttar Pradesh, India. Deepak Panwar, D. Pratap*	78
69	Antibiotic Resistance in Foodborne Pathogens in Milk in Lucknow District of Uttar Pradesh (India) Shruti Mishra*	79
70	Studies on genetic variability, heritability and genetic advance for various yield attributing traits in chickpea (<i>Cicer arietinum</i> L.) Karthikeyan M ¹ , Sharad Pandey ² , Gideon Synrem ² and Vivek Singh ²	79
71	Doubled Haploid Technology: Tool for Crop Improvement Anju Nehra*, Dr S S Poonia ¹ , Dr M L Jakhar ² , Dr D K Gothwal ³ , Manisha Shivran ⁴	80
72	Melissopalynology of honey samples during major and minor honey flow periods of kodagu district, Karnataka C N Nidhi *, R N Kencharaddi	80
73	Biological control: an important tool of IPM Mohammad Faisal and Sharad Pandey	81
74	Biofortification: A Sustainable Agricultural Strategy For Reducing Malnutrition Swati Kumari ¹ and Ritu Kumari ²	81
75	Relative performance of wheat (<i>Triticum aestivum</i>) varieties under different residue management and tillage systems Kapil Malik*, O. P. Lathwal ¹ , A. K. Dhaka ¹ , Abhilash ² and Pankaj Dah Iya ²	82
76	Foraging Behaviour of <i>Apis mellifera</i> L. on Onion, <i>Allium cepa</i> L. bloom Neeraj Kumar and G.S. Giri	82
77	Participatory approach in adoption of fodder cultivation technology towards increase in milk production in garhwa district of jharkhand Sushma Lalita Baxla ¹ , Ashok Kumar ¹ , Pankaj Seth ² , Sudhir Kumar Jha ¹ , and Sunita Kumari Kamal ³	82
78	Study of Diversity of Family Encyrtidae (Hymenoptera: Chalcidoidea) in Forest and Agricultural and horticulture Habitat of Doon Valley, Uttarakhand, India. Rashmi Nautiyal and Sudhir Singh	83
79	Seed priming: a useful technique for abiotic stress management of crops plants F. A. Khan*, Sumati Narayan, Moinuddin#, Mohammad Amir and Fasil Fayaz	83
80	Effect of harvesting stages on seed physiological quality characteristics of French bean (<i>Phaseolus vulgaris</i> L.)” under temperate conditions of Kashmir Ume Salma, F. A. Khan*, S. A. Bhat, Sumati Narayan, S. A. Mir, Showkat Ara, Moinuddin# and Fasil Fayaz	84
81	Hydroponic fodder production: a boon for landless farmers Moinuddin*, F. A. Khan, Sumati Narayan, Mohammad Amir and Fasil Fayaz	84
82	Prospects of hydroponic strawberry production in temperate region of India Saima fayaz, F. A. Khan, Sumati Narayan, Moinuddin#, Mohammad Amir and Fasil Fayaz	85
83	Effects of Foliar Application of Melatonin on Head Yield and Quality of Broccoli cv. Palam Samridhi Mansha Gul, F. A. Khan, S. A. Bhat, S. A. Mir, A. A. Malik, Amit Kumar, S. Narayan, Moinuddin and S. A. Lone	85
84	Effects of accelerated aging and subsequent priming on seed quality and biochemical change of onion (<i>Allium cepa</i> L.) Rifat Maqbool Bhat, Farooq Ahmad Khan, Imtiyaz Murtaza, Gul Zaffar ¹ , Moinuddin* and Rifat Ramzan	86

	Watercore – a physiological disorder of apple related to imbalance carbohydrate metabolism in fruit tissues	
85	Farooq Ahmad Khan, Sujat Ahmad Lone, Amit Kumar, Sajad Ahmad Bhat, Moinuddin [#] , Umme Salma, Fasil Fayaz and Saima Fayaz	86
	Physiological basis of sunburn development in fruits and vegetables	
86	Farooq Ahmad Khan, Sumati Narayan, Sajad Ahmad Bhat, Imtiyaz Muratza, Moinuddin and Sujat Ahmad Lone	87
	Effect of organic manures and biofertilizers on growth and seed yield of radish(<i>Raphanus sativus</i> L.) under temperate conditions of Kashmir.	
87	Iqtab Mushtaq Wani, Sumati Narayan, Farooq Ahmad Khan, Khurshid Hussain, Sameena Maqbool, Iftisam Yaseen	87
	Management of spot blotch of barley through different dates of sowing and chemical and organic amendments.	
88	Mohammad Amir, J P Srivastava, Maneesh Kumar, Rishabh Kumar Singh, Moinuddin ¹	88
	Mitigation of spot blotch of barley (<i>Hordeum vulgare</i> L.) through different nitrogen levels and PGPRs to maximize the seed quality	
89	Mohammad Amir, Maneesh Kumar, R B Singh, Rajesh Kumar ¹ and Hamsa P Prakash ²	88
	New record of twelve species of Encyrtidae (Hymenoptera: Chalcidoidea) from different states of India	
90	T. Krishna Chaitanya ¹ and S. Manickavasagam ¹	89
	Integrated Disease Management of Charcoal Rot of Sesame (<i>Sesamum indicum</i> L.) Incited by <i>Macrophomina phaseolina</i> (Tassi.) Goid.	
91	Kiran Choudhary and A. K. Meena	89
	Prominence of Carbon nanotubes - New Trend of Agriculture	
92	M. Lakshmi Durga	90
	Influence of salicylic acid application on growth characteristics and herbage yield of vegetatively propagated <i>Bacopa monnieri</i> (L.)	
93	Shamiya Jahan ¹ and Sonia Tamta ²	90
	Effect of organic manures and biofertilizers on seed yield and soil nutrient status after harvest of spinach beet (<i>Beta vulgaris</i> var. <i>bengalensis</i>)	
94	Asma Jabeen, Sumati Narayan, Geetika Malik, Sanjay Chadha	91
	<i>Spirulina</i> -derived bioactive compounds: emerging and potential source for food and medicine	
95	Manpreet Kaur ^{1*} , Surekha Bhati ² , Urmila Gupta ³ , Yamini Tak ⁴ , and Manoj Bali ⁵	91
	A Versatile Flavonoid Quercetin and its Health Benefits	
96	Yamini Tak ¹ , Rajendra Kumar ² , Manpreet Kaur ³ , Praveen Kumar Chachaiya ⁴	92
	Mapping of QTLs associated with drought tolerance component traits in wheat under multilocation irrigated and rainfed environments	
97	Shashikumara, P ^{1*} , Harikrishna ² , Neelu Jain ² , SV Sai Prasad ² , P. C Mishra ³ , P. K Singh ² , G. P Singh ⁴ and K. V Prabhu ⁵	92
	Flower waste management – a wonderful opportunity for uplifting economical status of rural women	
98	Gandham Aditya [*] , Rayavarapu Tejaswi ¹ and Zehra Salma ²	93
	Effect of irrigation salinity on morphological characteristics of rice genotypes.	
99	Megha Budakoti and Deepti Shankhdhar	93
	Evolution and global status of Cross laminated timber as Concrete of 21 st century	
100	Priyank Maithani, Shakti Singh Chauhan, Rakesh Kumar	94
	Therapeutic Management of Post-parturient udder edema in goats	
101	K.P. Singh ^{*1} , R.V. Singh ² , R. A. Siddique ³ , Praneeta Singh ⁴ and S. K. Singh ⁵	94
	Market Arrivals and price behaviour of Wheat in APMC, Akola (M.S.)	
102	Sulbha M.Sarap ¹ Dr.Devyane K.Nemade ² Dr.Sunil N.Ingle ¹	94

103	<i>In vitro</i> screening of botanicals and bio-agents to manage black scurf of potato disease, caused by <i>Rhizoctonia solani</i> Tania Nuri	95
104	Assesment of Potential therapeutic properties of Green tea Aqueous extract against Imidacloprid toxicity in Chick Tejinder Kaur Chhabra	95
105	Growth and Instability in Area, Production and Productivity of Coffee in Kodagu district and Karnataka state Thanuja P ^{1*} , G.L. Meena ¹ , Babita Kumari ²	96
106	Information and communication technology: concept and constraints faced by students Gargi Paliwal ¹ , Dr.D.K. Singh ² , Samarjeet Singh ²	96
107	Diversity analysis and clustering of chickpea genotypes using SSR markers Nimita Kandwal and R. K. Panwar	96
108	Development of union fabrics from blended yarns of delignified <i>dhaincha</i> fibres with cotton and bamboo fibres Pooja Bhatt and Anita Rani	97
109	Integrated management of <i>Fusarium</i> Head blight in North Eastern Gangetic plains Gnanasing J. Maharaja, S. Hembram, M. K. Debnath, P. M. Bhattacharya, A. Roy, A. K. Chowdhury	97
110	Genome editing for climate resilience crops, an underlying genesis in crispr tool Divakar, S. and S.Pazhanisamy	98
111	Effect of different cropping systems on enzymztic activities in calcreous soils of Bihar Vivek Kumar ¹ , Munmun Majhi ² , Sanjay Kumar Singh ³ , Kaushal Kishor ¹ and Rahul Kumar Raushan ¹	98
112	Studies on effect of tillage and cultivars on yield and yield attributes of rice (<i>Oryza sativa</i> L.) under conservation tillage systems Ankit*, Sandeep Manuja, Suresh Kumar, Shabnam Kumari and Nikhil Dogra	99
113	Strains associated with the nature of work among women tea pluckers of Assam Alinda Kashyap, Manorama Devi, Shishir Kala and Neetu Kumari	99
114	Impact of Climate Change on Soil Structure and Properties in the Himalayan Region Anil Kumar*, Manju Kandpal	100
115	Plant biodiversity enhances bees and other pollinators in agro ecosystems Mohammad Rizwan ¹ , Mohammad Imran ² , S.K. Sachan ³ , Nazim Ali ⁴	100
116	Application of information and communication technology in agriculture Gargi Paliwal ¹ , D.K. Singh ² , Samarjeet Singh ²	100
117	Indian traditional methods of water storage and purification for a healthy life S. Nikil** and A. Bharani*	101
118	Evaluation of granular insecticides against yellow stem borer and leaf folder in rice S. S. Thorat*, R. K. Gangwar, M. B. Parmar, D. B. Prajapati, S. G. Patel and D. J. Kacha	102
119	Grain amaranth (<i>Amaranthus hypochondriacus</i> L.) yield and economics under sulphur fertilization in rainfed hilly region of Garhwal Himalayas Rahul Rana, Arunima Paliwal*, Ajay Kumar, Shikha ¹ and Gargi Goswami ²	102
120	Biomimetic textiles: An innovative approach towards conserving the future Pratikhya Badanayak* and Jyoti V. Vastrad	103
121	Environmental challenges and sustainable development	103

3rd International Conference on “Global Initiative in Agricultural, Forestry and Applied Sciences for Food Security, Environmental Safety and Sustainable Development (GIAFAS-2021)”

	Rahul Kumar Maurya, Ashish Kumar, Niyaz Ahamed and D.K. Dwivedi Efficacy of herbicides on weed dynamics and seed yield of finger millet (<i>Eleusine coracana</i> (L) Gaertn.)	104
122	Amit Kishore, Ajay Kumar, Arunima Paliwal, Bhim Jyoti, Sumit Chaudhary and Kanchan Harbola	
123	Legume protease inhibitors (pi's) for curtailing insect pest menace Ankur Tripathi, Rabiya Basri, Shailesh Kumar Singh, Shama Parveen, Nitika Nehal	104
124	Edible coatings with active agents for shelf-life extension in fruits and vegetables Sadaf Ahmad ^{1*} , Nazia Tabassum ²	105
125	Habitat Management of Green lacewings: A Potential Biocontrol Predator in Agroforestry System Tanmaya Kumar Bhoi*, Sangeeta singh ¹ and Shiwani Bhatnagar	105
126	Information communication technology in agriculture Akanksha Sharma ¹ , Babita Baghel ²	106
127	Farm mechanization and post harvest technologies to enhance farm profitability Babita Baghel, Akanksha Sharma	106
128	Weed dynamics and wheat performance as influenced by different fertility levels and herbicides Sarita ^{1*} , Ishwar Singh ² and M.L. Mehriya ²	107
129	Protection of Plant Varieties and Farmer Rights Act and its role in Germplasm Collection Bonani Kakoty ^{1*} and Alongber Basumatary ²	107
130	Endophytes and their role in sustainable agricultural practices Akanksha Rathore*, Neerja Rana and Ranjna	108
131	Eminence attributes of okra (<i>abelmoschus esculentus</i> L. Moench) pods as pretentious by cultivar and fruit size Tanu shiri*, Shailendra S. Gaurav, S.K. Singh and S.Jain	109
132	A green and facile approach for Anti-inflammatory potency of <i>Ficussubincisa</i> Fruit Abha Shukla, Priyanka Pokhriyal and Supriya Dubey	109
133	A reseach on e-commerce agri business in scope and status in india N. Hariharan	109
134	Effect of mulches and fertigation on yield of turmeric (<i>Curcuma longa</i> L.) Chanchal Nikam, V. S. Kale and A. P. Pawar	110
135	Priming: Seeds retain their germination overstretch Guntha Adhithya	110
136	Farmers' Perception about Climate Change: A prerequisite for appropriate adaptation measures at farm level Neha ¹ and Mohammad Aslam Ansari ²	111
137	Population genetic analyses of potato cyst nematode <i>Globodera rostochiensis</i> using microsatellite markers Amit Ahuja*, M. R. Khan, and Vishal Singh Somvanshi	111
138	Effects of nanofertilizers on wheat Influence of Silty Clay Loam Soil and Sand conditions on Agricultural Disc	112
139	abrasive wear Annu Rani*, T. P. Singh, Jayant Singh	112
140	Bacteria-derived luminescent carbon quantum dots for antibacterial activity Megha Pant, Veena Pande and Anirban Dandapat*	113

141	Synthesis and characterization of novel heterocyclic 2-Aminopyrimidine Schiff bases as fungitoxic agents. Amanpreet Kaur ^{1*} , Sunita Sharma ² , Diksha Verma ¹ , Tanvi Sahni ¹ and Sukhmanpreet Kaur ¹	113
142	Utilization of shrimp shell meal derived natural astaxanthin with its synthetic variant enhanced antioxidative status and immune responses in <i>Symphysodon aequifasciatus</i> (Pellegrin, 1904) Ramjanul Haque*, Paramita Banerjee Sawant, Parimal Sardar, Tincy Varghese, K.A Martin Xavier, and Narinder Kumar Chadha	113
143	An account of tribe chaetostichini (chalcidoidea: trichogrammatidae) egg parasitoids from jammu & kashmir (India). Yawar Manzoor Bhat ^{1*} and Mohd. Yousuf ²	114
144	Cultural Significance of Medicinally Important Wild Edible Fruits in North Kashmir with Reference to District Bandipora Gousiya Majeed, Rayees Afzal Mir, Syed Aasif Andrabi Hussain. Mohd. Gulfishan	114
145	Low-cost polyhouse technology for quality production at lower cost Anand Nagsen Warghat* Shyamkant Munje, H.H. Dikey and R.S. Wankhade	115
146	True morels, <i>Morchella</i> from Jammu and Kashmir-Biodiversity, Nutritional and Phytochemical composition, Health benefits, Sustainable conservation and Marketing: A Review Eyram Hamid and Mehnaz Aijaz	115
147	Afforestation and Development of Wasteland through Agroforestry Kushmita Dhan, Firoz Ahmad, B.C Oraon	115
148	Study of hymenopteran insect pollinators in district Baramulla of Jammu and Kashmir Shafkat Jabbar. Mohd Majid Jamali, Rayees Afzal Mir, Syed Aasif Hussain Andrabi	116
149	A review on organic weed management in Okra Sidra Qidwai, A. K. Singh, Niyaj Ahmad	116
150	Forest cover change and its environmental impact in Kupwara region of Jammu and Kashmir through remote sensing Sajjad Ahmad Khan	117
151	Field evaluation of novel botanical based formulation against <i>Meloidogyne incognita</i> infesting turmeric cultivation as intercrop under Coconut cropping system Rashid Pervez ¹ , Rajkumar ² , Leela N.K. ³ , Santhosh J. Eapen ³ and Surekha R. ²	117
152	Zero Budget Natural Farming of vegetable crops in India Omkar Aralikatti*, Vinay Verma, Aman Deep Ranga, Divya Arti and Shraddha Pundeer	117
153	Selenium nanoparticles stimulate growth and defence response in <i>Anabaena variabilis</i> under paraquat stress Haleema Naaz, Nida Jamil Khan & Tasneem Fatma*	118
154	Effect of different growth regulators on stem cuttings of Poplar (<i>Populus deltoides</i>) Satyen Chhetri, Dharmveer	118
155	Synthesis of azomethines and β -lactams of aza heterocycles and antifungal evaluation against <i>Rhizoctonia solani</i> Diksha Verma ^{1*} , Sunita Sharma ² , Tanvi Sahni ¹ , Amanpreet Kaur ¹ and Sukhmanpreet Kaur ¹	119
156	Methods of breaking hardseededness in mungbean Adhithya, G. and Siddaraju, R.	119
157	Impact of imidazolinones on weeds in pigeon pea (<i>Cajanus cajan</i> L.) Amit Kumar*, A.K. Dhaka, Satish Kumar and Rajesh Kathwal	119

158	Essential Oils Effectively Manages, Anthracnose of Chilli caused by <i>Colletotrichum capsici</i> during storage Anand Milan*, Sobita Simon, Abhilasha A. Lal and R K Prajapati	120
159	Effect of nutrients and growth regulator on growth and yield parameters of ber (<i>Ziziphus mauritiana</i> Lamk.) cv. Apple ber Sumit, Satpal Baloda*, Jeet Ram Sharma, S.K. Sehrawat, Sushil Sharma, Arvind Malik and Sakshi	120
160	Assessment of Wheat yield Under Climate Change in the Indian States Pankaj Dah Iya ¹ , Abhilash ¹ , Kapil Malik ² and Ekta Patha K Mishra ³ Bael-a medicinal tree & its conservation an dreligious value in india K.P.Dwivedi, R.P.Bain and A.K.Tomar	120
161	Need of conservational strategies of medicinal plants in Kashmir Himalayas. Bilques Aashiq. Dr. Rayees Afzal Mir, Dr. Mohd. Gulfishan, Dr. Syed Aasif Andrabi Hussain	121
162	Bringing colours to food: Bell pepper Divya Arti	121
163	Effect of organic, integrated and inorganic nutrient sources on plant height, tiller numbers leaf area index and total chlorophyll content of Pant Basmati I (<i>Oryza sativa</i>) Sheela Rautela* and Gurdeep Bains	122
164	Influence of salicylic acid application on growth characteristics and herbage yield of vegetatively propagated <i>Bacopa monnieri</i> (L.) Shamiya Jahan* and Sonia Tamta	122
165	Production and Immobilisation of amylase from thermophilic Bacteria from manikaran hot spring water and its application in food industry Neerja Rana ¹ , Majneesh ¹ , Devina Vaidya ² and Neha Verma ¹	123
166	Detection of Adulteration in Milk Samples from retail shop and local vendors of Jaipur, Rajasthan, India Rizwan Khan*, Raghavendra Prasad Mishra and A.Bhattacharya	123
167	Economic Study of Pigeon pea (Tur) Devyanee K. Nemade ¹ , Sulbha M. Sarap ² and N.V. Shende ³	123
168	Phenology of flowering and fruiting extent in Nagpur mandarin (<i>Citrus reticulata</i> Blanco) under Central India conditions R. K. Jhade ^{1*} , A. D. Huchche ² and S. K. Pandey ³	124
169	Characterization of amylase producing bacteria isolated from hot water spring (jeori, shimla) and role in clarification of juices and bun making Neha Verma* and Neerja Rana	124
170	The Role of Salicylic Acid in Plants Exposed to Heavy Metals Fatima Shabir	125
171	Fortification Additives and Nutritional Spectrum of Food Sangeeta	125
172	Govt. Policies and planning for Sustainable Development of Agriculture FPO; a step forward to Succeed Amit Dixit, Pappu Lal Bairwa	126
173	Genetic improvement of <i>Capsicum annum</i> L. through induced mutagenesis Mohd Gulfishan*, Rayees Afzal Mir, Syed Aasif Hussain Andrabi, Ajmat Jahan	126
174	Integrated farming system: a boon for farmer's income in rural India Hrishikesh Nath ^{1*} , Dr. Rajan Kumar ² , Dr. Biswajit Pramanick ²	127
175	Contribution of green technologies in sustainable development Ragini Kumari*, Mona Kumari, Shailja Kumari, Gopal Kumar, Rajeev Padbhushan and Rajkishore Kumar	127

176	Attitude of Farmers towards Drip Irrigation: A Study in Kumaon Hills of Uttarakhand Pooja Karki and Amardeep	128
177	Plant growth promoting rhizobacteria (pgpr): an ecofriendly approach forsustainable agriculture and abiotic stress management Ranjna*, Neerja Rana and Akanksha Rathore	128
178	Biodiversity and ethnobotanical use of plants of district upwara, J&K, India LaraibAhad, Dr. Rayees Afzal, Dr. MohdGulfishan, Dr. Syed Aasif Andrabi Hussain	129
179	Monitoring of water pollution caused by aminophenols by degradation with oxone: A kinetic-spectrophotometric study Manila & Neha Bhatt	129
180	Effects of different media on the <i>in vitro</i> shoot induction of <i>Elaeocarpus ganitrus</i> Manisha Chaudhary ¹ , Rishi ^{1*} , Harinder Vishwakarma ² , Sandeep Kumar ^{1*}	130
181	Nutritional Aspects of <i>Moringa oleifera</i> Lam. Mohit Kundal	130
182	Influence of Nitrogen with Different Organic Sources on Yield and Quality of Peanut (<i>Arachis hypogaea</i> L.) Moinuddin ¹ , Wajid Hasan ² , Farooq Ahmad Khan ³ and Tahir Ali ⁴	130
183	Indigenous knowledge of medicinal plants: a case study of Gulmarg area of J&K Muzamil Mohiuddin. Dr. Rayees Afzal Mir, Dr. Mohd. Gulfishan, Dr. Syed Aasif Andrabi Hussain	131
184	Utilization of <i>Trichoderma spp.</i> for growth promoting and controlling <i>Fusarium oxysporum</i> disease of <i>Ocimum tenuiflorum</i> (Linn.) Nasreen Musheer* and ShabbirAshraf	131
185	Evaluation of Modified Onion Storage Structure under Northern dry zone of Karnataka P. V. Naik, Zaheer Ahamed, RajuTeggeli, Mahantesh Jogi, Yusufali and Shreenivas B.V	131
186	Organic Production of Vegetable Crops from Farm Generated Inputs Vinay Verma	132
187	Assessing the relationship of Human Ecological Variables on Linguistic Intelligence of Elementary Boys Priyanka*, Sudha Chhikara and Diksha	132
188	Speed breeding: a promising tool to crop breeding Aman Deep Ranga	133
189	Fabrication of Syringic Schiff bases and β -lactams along with their antimicrobial evaluation Tanvi Sahni ¹ , Sunita Sharma ² , Diksha Verma ¹ , SukhmannpreetKaur ¹ and AmanpreetKaur ¹	133
190	Transgenics in vegetable crops Ankush Chaudhary	133
191	Impact of climate change on incidence of major soybean and black gram diseases under Bundelkhand Agro-climatic zone U.S. Dhakad, R.K. Prajapati, B.S. Kirar, I.D. Singh and Jai Pal Chhigarh	134
192	Interactive effect of <i>Meloidogyne incognita</i> and fly ash on the growth, physiology, and antioxidant properties of carrot (<i>Daucus carota</i> L.) Adnan Shakeel*, Abrar Ahmad Khan	135
193	A study of customer relationship management practices of J&K Zakir hussain khandy	135
194	Significance of Organic Manures on the Growth and Yield of Indian Spinach (<i>Beta vulgaris</i> var <i>bengalensis</i>) under Low-Hills of Uttarakhand Alice Kaintura [*] , Dr Suneeta Singh ² and Dr Anil Kumar Saxena ¹	136

195	Production, optimization and characterization of siderophore produced by fluorescent pseudomonads and its application in growth suppression of pathogen (Plant and Human) and enhancement of Mustard plant Apoorva Dixit, Chhaya Verma, Rajesh Kumar	136
196	Effect of Green synthesized iron oxide nanoparticles on growth and development of mung bean Samia Saleem and Mohd. Saghir Khan	136
197	Trees for Remediation Desha Meena ^{1*} , Shiwani Bhatnagar ²	137
198	Climate-resilient agriculture for ensuring food security in the face of climate change with special reference to Arunachal Pradesh, india Dipak Sharma*, SailajanandaSaikia, Jyoti Saikia	137
199	A kinetic mechanistic study of hexacynoferrate (III) oxidation of o-aminophenol to 2-aminophenozin-3-one in aqueous alkaline medium Anjali Goel and Monika Rani*	137
200	Food and nutrition security for gender equality Renu Gangwar ¹ , Dharendra Kumar Singh ² and Amita Yadav ³	138
201	Eco-Friendly Textiles: Fostering Sustainability and Accountability Arpita Grover* and Nisha Arya	138
202	Antibacterial potential of synthesized silver nanoparticles using bioactive metabolites of actinobacteria against Bacterial meningitis Naushin Bano ¹ , Roohi ¹ , Mohammad Amir ¹ and Saba Siddiqui ^{2*}	139
203	Effect of altitude and aspect on vegetation structure, carbon density and soil nutrients in shankaracharya Forest. Mohsina Niyaz, Dr. Syed Aasif Hussain Andrabi, Dr. Rayees Afzal Mir, Sajjad Ahmad Khan	139
204	Studies on distribution of fruit flies (diptera: tephritidae) in mango orchards of saharanpur district of Uttar Pradesh DilMahjoora Majeed* MohdMajidJamali & Rayees Afzal Mir	140
205	Identification of high yielding stable genotypes of finger millet by using GGE Biplot AMMI analysis Ekhlaque Ahmad* and Abdul Majid Ansari	140
206	Nanotized plant growth regulators and its effect on growth, yield and essential oil production in <i>Coleus aromaticus</i> Naushin Quasar* and M Masroor Akhtar Khan	141
207	Present Status, Problem and Prospect of Duck Farming in Kolhan Region of Jharkhand Pankaj Seth ¹ , Sushma Lalita Baxla ² and Jagarnath Oraon ³	141
208	Delineation of ground water potential zones using remote sensing, gis and geophysical technique in Harahua block, district Varansi, Uttar Pradesh Ritu Jain	142
209	Growth and biomass production of <i>Bombax ceiba</i> L. plantations after six years in relation to stand density Rodda Chandana Devi, D.K. Das and S. Pazhanisamy ¹	142
210	Investigation of the allelopathic potential of <i>Parthenium hysterophorus</i> L. and <i>Pinus roxburghii</i> Sarg. on Tulsi (<i>Ocimumtenuiflorum</i>) Monali Chauhan*, Sonam rawat, Pallavi Sati, M.C. Nautiyal	142
211	Effect of circular saw blade’s constructional and operational features on cutting torque requirement in context of henna harvesting Shital Sonawane ¹ , A.K. Mehta ² , Ajay Kumar Sharma ³ , S.S. Meena ⁴ , N.L.Panwar ⁵	143
212	Revival and contemporizing of traditional Khana doobby designs into jacquard woven kurta materials	143

	Pratikhya Badanayak* and Sadhana D. Kulloli	
	Impact of Joint Forest Management Programme on livelihood of Rural People in Jammu Division of Jammu and Kashmir	
213	Tariq Iqbal ¹ , P.S. Slathia ¹ , Rajinder Peshin ¹ , Sandeep Sehgal ² , Manish Kumar Sharma ³ , Kiran Kour ⁴ , Rakesh Kumar ¹ , S.K. Gupta ² , and Bharat Bushan ⁵	144
214	A review on Process Technology for Milk Cooling and Chilling	144
	Kumar Ashok ¹ , Jain SK ² , Jain NK ² , Lakhawat S S ² , Kumar Arun ²	
215	Trichoderma and Nanotechnology: Combining Biocontrol with Bio-efficacy	145
	Efath Shahnaz*, Saba Bandy, Ali Anwar, QadrulNisa, Gazala Gulzar and T. A. Sofi	
216	Molecular identification of host-specific phytopathogens isolated from <i>Macrotyloma uniflorum</i> plant and assessment of their potential bio-control agents	145
	Pooja Pant ¹ , Ankit Negi ¹ , Sushma Tamta ² and Rishendra Kumar ^{1*}	
217	Effect of Land Configuration and Integrated Nutrient Management on Growth, Yield and Economics of Pigeon pea (<i>Cajanus cajan</i> L. Millsp.) Under Rainfed Condition”	146
	Neha Singh, Kiran D.S. Sasode, Varsha Gupta, R.P. Prajapati	
218	Agroforestry- alternative land management for sustainable development	146
	Supriya K Salimath ^{1*} , Deepthi Dechamma N L ¹ , Clara Manasa P A ¹ , Maheshwarappa V ¹ Ramakrishna Hegde ¹ and Ashwath M N ²	
219	Seasonal Effect on Physicochemical Properties of Soil Samples from test sites of Bamboo Plots	146
	Abha Jha and Sunila Das	
220	Ginger Exports from India: A Markov chain analysis	147
	Namami Gohain ¹ , Surbhi Bansal ² , Shruti Mohapatra ³	
221	Investigation about the lipid composition of some freshwater fishes	147
	Basant Kumar ¹ and Abha Jha ²	
222	The process of making fossils record more widely applicable	148
	Shivam Mani Tripathi	
223	Studies on the Chickpea (<i>Cicer arietinum</i> L.) wilt in relation to variation in the pathogen (<i>Fusarium oxysporum</i> f. sp. <i>ciceri</i>) and its eco-friendly management	148
	Mohammad Faisal and Shashi Tiwari	
224	Effect of soy protein isolate as foaming agent on the physicochemical properties of the persimmon (<i>Diospyros kaki</i> L) fruit pulp during foam mat drying	149
	Anjum Ayoub	
225	Survey on timber yielding plants of six tehsel of district Rampur	149
	Sompal Singh	
226	Intervention under use of value Added Jaggery for Increasing	149
	Rashmee Yadav ¹ , Brij Vikash Singh ² and Sarita Bharti ³	
227	Effect of Bionanoconjugate of Indole Acetic Acid on Seed Germination in Cotton (<i>Gossypium hirsutum</i> L.)	150
	Shiwani Mandhania, Vikram Singh*, Rashi Datten, Sonika Jakhar, A. Aravind Reddy	
228	Organic farming: A new paradigm for pest control in cucurbits	150
	Sunidhi Pilania*, Krishna Rolania, Surender Singh Yadav, Amit Kumar	
229	Response of Budload and Fertilizer on Berry Shape, Quality and Shot berry disorder in Grapes cv. Sahebi	150
	Aroosa Khalil*, Newsheen Nazir, Shaila Din, M.K. Sharma, Amit Kumar	
230	Estimation of queen rearing techniques for quantitative queen characters in <i>Apis mellifera</i>	151
	Rajan Kamboj* and Surender Kumar Sharma	
231	A study on the performance of print media in popularization of new cultivation technology in Fenugreek at Neemuch District	151

3rd International Conference on “Global Initiative in Agricultural, Forestry and Applied Sciences for Food Security, Environmental Safety and Sustainable Development (GIAFAS-2021)”

	P.S.Naruka, Shilpi Verma, S.S.Sarangdevot, C.P.Pachauri and J.P.Singh	
232	Study on the nesting behavior of <i>Apis cerana indica</i> F. feral colonies with respect to comb parameters	152
	B.V. Shwetha, Bharath Kumar. A. K and K.S.Jagadish	
	Pigmented Rice and its Utilization in Food Industry	
233	Faruk Ansari*, Devina Vaidya, Manisha Kaushal, Anshu Sharma, Sanjay Patidar, Priyanka Arya, Anupama Anad, Kavita Thakur, Ruchi Sharma, Harpreet Kaur Saini and Chahat Thakur	152
234	Development of process protocol for sugarcane juice	152
	Priyanka Chauhan*, Manisha Kaushal, Devina Vaidya, Faruk Ansari	
235	Fruits and Vegetables Processing Waste Utilization in Food Packaging	153
	Sanjay Patidar*, Devina Vaidya, Manisha Kaushal, Anshu Sharma, Faruk Ansari, Priyanka Arya, Anupama Anad, Ruchi Sharma, Harpreet Kaur Saini and Chahat Thakur	
236	Role of plasma technology in food	153
	Kavita Thaku ^{1*} and Faruk Ansari ²	
237	Growth Behavior and Productivity Status of Wheat under <i>Dalbergia sissoo</i> (Roxb.) based Agri-silviculture System	154
	Priya Jaiswal and Yashpal Singh	
238	Biofortification of rice- a brief overview	154
	Takhellambam Julia, Sushilkumar S., Rimamay K. and N. Sunita Devi	
239	Silver nanoparticles in dentistry: An emerging trend to combat oral diseases	155
	Mohd Sajjad Ahmad Khan*	
240	Devil disaster of India: Floods and their blow on rural economy of India	155
	Alongber Basumatary*, Sudhanand Prasad Lal, Biswajit Mallick and Srishti Paliwal	
241	Income analysis of production and marketing of Potato (<i>Solanum tuberosum L.</i>) under different marketing channels	156
	Vishwas Deep and Amita Girdhar*	
242	The influence of groundwater desalination by bentonite / modified active carbon on its application in agriculture	156
	Mohamed Eid Abdelhamid Elsayed	
243	Impact of rice residue management options and fertilizers on yield and yield attributes of rice (<i>Oryza sativa</i>)	157
	Kavita ¹ , Dev Raj ¹ and Kavinder ²	
244	Management of soil fertility with incorporation of crop residues for sustainable crop production under Bundelkhand Agro-climatic zone	157
	R.K. Prajapati, B.S. Kirar, U.S. Dhakad and I.D. Singh	
245	Enhancement in Crop Production through Hydrogel	158
	Bhawani Singh Prajapat* and M. K. Kaushik	
246	Validation of Ovsynch and Heat Synch Protocol in Post Partum Anoestrus Cows	158
	Dinesh Mahto	
247	Diversity and Community Structure Of Plant And Soil Nematodes Associated With Sugarcane (<i>Saccharum Officinarum</i>) From District Shamli (Uttar Pradesh)	159
	Rashid Pervez* And Uma Rao	
248	Efficacy of pre and post-emergence herbicides on weed density, weed dry weight and growth and yield of direct seeded puddled wet rice under Cauvery command area Karnataka	159
	Nagesh C. R. Sathisha C. and Vinutha B. B	
249	Diversity of Entomopathogenic Nematodes from Different Districts of Western Uttar Pradesh	159
	Rashid Pervez* and Uma Rao	

250	Evaluation of different formulation of <i>Trichoderma viride</i> on seed germination, root length and shoot length of Bengal gram	160
251	Isolation, evaluation and characterization of disease suppressing Plant Growth Promoting Rhizobacteria (PGPR) of lentil rhizosphere Niyaj Ahamad, Adesh Kumar, N.A. Khan	160
252	Indigenous Versus Advanced Preparedness Strategies Adopted by Farmers in Cyclone Vulnerable Region of Odisha Biswajit Mallick, Sudhanand Prasad Lal, Alongber Basumatary and Srishti Paliwal	160
253	Studies on Diversity of Edible Wild Mushrooms In Semarsot Wildlife Sanctuary, Chhattisgarh Bhavna Dixit* and Reshma Ekka	161
254	Selenium nanoparticles stimulate growth and defence response in <i>Anabaena variabilis</i> under paraquat stress Haleema Naaz & Tasneem Fatma	161
255	Effect of Monsoon Season on Different Stocking Density of <i>Litopenaeus Vannamei</i> (Boone, 1931) Growth, Survival in Province of Gujarat State in India	162
256	Biorational: New approach in plant protection Vijay Laxmi Rai and Dharendra Pratap Singh	162
257	Influence of Bio-Stimulants on Growth and Yield of <i>Aggregatum Onion Var. Co 4</i> Ragulraj, H., *Ramesh Kumar, A. and Srivignesh, S.	162
258	Major Problems Faced by Selected Dairy Farmers in Haryana State Manju Loura and Suman Ghalawat	163
259	Effect of Micro Irrigation On Water Use Efficiency And Yield of Bitter Gourd In Summer Season Vinay Kumar, Uday Kumar Singh, Anil Kumar, Neena Bharti and Rupa Rani	164
260	Priming: Seeds retain their germination overstretch Guntha Adhithya	164
261	Response of zinc sources on yield and quality of soybean (<i>Glycine max</i> L. Merrill) grown under acidic upland soil conditions of Nagaland	165
262	Eminence Attributes Of Okra (<i>Abelmoschus Esculentus</i> L. Moench) Pods As Pretentious By Cultivar And Fruit Size Tanu shiri ^{1*} , Shailendra S. Gaurav ¹ , S.K. Singh ² and S. Jain ¹	165
263	Effect of GA ₃ and NAA on growth and physiological attributes of bishop’s weed (<i>Ammi majus</i> L.) Aman Sobia Chishti ^{1*} , Sarika Singh ¹ , Sangram Singh ¹ , Urooj Hassan Bhatt ¹ , M. Masroor A. Khan ¹ and Moin Uddin ²	165
264	Impact of Farm Pond Technology on Economic Development of the Farmers in Palamu District of Jharkhand Ashok Kumar Sinha ¹ , Rajiv Kumar ¹ , Ramesh Kumar ¹ , Vinay Kumar ² and Sanjay Kr. Ram ¹	166
265	Fertility parameters’ estimation of Kurnool soils using AVIRIS-NG hyperspectral reflectance data Ali R.A. Moursy ^{1*} , R.N. Sahoo ² , Nayan Ahmed ³ , Shalini Gakhar ² , and Bhabani P. Mondal ²	166
266	Vegetable Cultivation in Mizoram: Status, Sustainable Approaches and Future Scope Saraswati Pandey ¹ and Suryakant Choubey ²	167
267	Success Stories on Empowering Farmers Through Horticultural Technologies In Dehradun Region Of Uttarakhand S.S. Singh*	167

268	Effective Dissemination of Pick Bag Technology through Media Form Nisha Arya and Nirmala Yadav	168
269	Effect on India Agriculture Due to Climate Change Shishir Kumar Kaushal ¹ , Ekta Sharma ¹ , Ratnakiran Wankhade ² and Hemant Kumar Singh ¹	168
270	The modernization Pumped hydro Energy Storage small Hydro Power plant Ekta Sharma ¹ , Shishir Kumar Kaushal ² and Ratnakiran Wankhade ³ Factors Influencing the Use of Vermicompost among Farmers in Sirsa District, Haryana	169
271	Megha Goyal ¹ , Sagar Mehta ² and Nitin Kumar ³ Studies on resistance to <i>in-situ</i> germination in inter-specific derivatives of mung bean (<i>V. radiata</i> × <i>V. radiata</i> var. <i>sublobata</i>)	169
272	R.A. Jadhav, S.P. Mehtre, D.K. Patil and V.K. Gite Forest Fire: An Changes The Environmental Condition	170
273	Harischadra Darro ¹ and Rajesh Kumar ² Assessment of Improved Production Practices on Fibre Yield and Quality of Jute in Murshidabad district of West Bengal	170
274	Amrita Kumar Sarkar*, Sudhanand Prasad Lal and Dasikonda Sangeeth Pradhan Mantri Ujjwala Yojana: An Overview of Phase 1 & Phase 2	171
275	Srishti Paliwal *, Ashok Kumar Singh, Biswajit Mallick, Alongber Basumatary and S.P.Lal Impact Assessment of PM-KISAN Yojana: its lacunas & corrective measures	171
276	Rishabh S. Gaur*, Karunesh Verma, Biswajit Mallick and Sudhanand Prasad Lal Adoption of High Density Apple (<i>Malus Domestica</i>) Plantation And Its Economic Impacts On Rural Livelihood Of Darchula District, Nepal	172
277	Binod Pokhrel ^{1*} , Suman Bhattarai ² and Ankit Ojha ³ Need and Scope of Aquaculture apropos Economic and Nutritional Security: an Indian Perspective	172
278	Karunesh Verma*, Rishabh Singh Gaur, Amrita Kumar Sarkar and S. P. Lal Organic manure as an alternative to the conventional mineral fertilizers in cultivation of <i>Digitalis purpurea</i> L.	173
279	Yashwant Singh Tariyal*, Sadaf Ansari and Pratti Prasad Impact of Salicylic acid on Morphological traits of <i>Valeriana wallichii</i> DC under Drought stress	174
280	Sadaf Ansari, Yashwant Singh Tariyal and Babita Patni Study on Knowledge and adaption of soil testing regarding utility of soil health card in Maharajganj district of Uttar Pradesh	174
281	Girijesh Kannaujiya ¹ , R.K. Doharey ¹ , Abhinav Singh ¹ , Niyaj Ahamad ² Genetic variability and association studies of marketable traits in gladiolus (<i>Gladiolus hybridus</i> Hort.) in Bundelkhand Conditions	175
282	Rakesh Kumar*, Ajay Kumar Singh, Krishna Singh Tomar and Amit Kanawjia Influence of Potting Media Composition On Quality Flower Production Of Petunia (<i>Petunia Hybrida</i>)	175
283	Ajay Kumar Singh, Rakish Kumar, K.S.Tomar, Arvind Gupta, Hitesh Kumar and Rahul Patel Agricultural Crop Residue Utilization for Sustainable Bioenergy Production: an Asian Perspective	176
284	Jayashree Dey Sarkar ¹ , Amrita Kumar Sarkar ² , Prithusayak Mondal ³ , Prasanta Kumar Bandyopadhyay ¹ , and S. P. Lal ² Drought stress related grain quality traits of wheat (<i>Triticum aestivum</i> L.) varieties	176

- Dommalapati Sudhakara Rao^{1*}, Midathala Raghavendra¹, Parveen Gill², Shashi Madan¹ and Renu Munjal³
- 285 Impact of Trichoderma linked IDM trainings on management of Major Diseases of Horticulture Crops in Kalaburgi District of Karnataka 177
Zaheer Ahamed, B , Vasudev Naik, Raju Teggelli G, Yusuf Ali N and Shreenivasa B V
- 286 Strengthening Marketing Through E-Commerce 177
Parveen Kumar¹ and Vijay Kumar²
- 287 Socio-economic and communication characteristics of farm women using ICT tools 178
Shivani Jha^{1*}, S. K. Kashyap², M. A. Ansari², Deepshikha Gariya², Smriti Singh²
- 288 Antibacterial potential of methanol extract of invasive plant *Sonchus wighitianus* DC. leaf from Kumaun Himalaya 178
Amrendra Nath Tripathi and Suresh Chandra Sati
- 289 Lemon grass-a new paradigm for farmers, eco-systems and sustainable development of livelihood under Bundelkhand Agro-climatic zone 178
B.S. Kirar, R.K. Prajapati and Jaipal Chhigarh
- 290 Lemongrass comes as boon for drought-hit Bundelkhand Agro-climatic zone farmers 179
T. R. Sharma, R.K. Prajapati and P.K. Gupta
- 291 Molecular characterization of monopartite *Bhendi yellow vein mosaic virus* infecting wild okra (*Abelmoschus moschatus* ssp. *moschatus*) in India 180
Pooja Kumari^{1*}, SP Singh⁵, KK Gangopadhyay², VC Chalam¹, Basavaraj Y. B³, V. Venkataravanappa⁴, Ashwini Kumar³ and Satish Kumar Yadav⁶
- 292 Evaluation of Modified Onion Storage Structure under Northern dry zone of Karnataka 181
P. V. Naik, ZaheerAhamed, MahanteshJogi, RajuTeggeli, Yusufali and Shreenivas B.V.
- 293 X-Ray Induced Mutagenesis For Improved Grain Yield And Nutritional Value Of Maize (*Zea Mays* L.) 181
Oke, EJ^{1*}, Yilwa, VM¹; Appah, J¹, Mbah, EU², Kwon-Ndung, EH³
- 294 Loss of Food Grains Due to Insect pests in Storage 182
Shashi Bala
- 295 Multi-facet Approach to recycle household waste into wealth: a Case Study of a Lady having Zero waste Lifestyle 182
Nisha Arya and Sudhanand Lal Prasad
- 296 Effect of irrigation salinity on morphological characterstics of rice genotype Megha Budakoti 183
- 297 Investigation of the allelopathic potential of *Parthenium hysterophorus* L. and *Pinus roxburghii* Sarg. on Tulsi (*Ocimum tenuiflorum*) 183
Monali Chauhan*, Sonam rawat, Pallavi Sati, M.C. Nautiyal
- 298 New locality record of Yellow-bellied House Gecko *Hemidactylus flaviviridis* Rueppell, 1835 (Reptilia: Squamata: Sauria: Gekkonidae), a potential biological controller, from Shikohabad, Firozabad district, Uttar Pradesh (India) with its systematic account, distribution and other aspects 183
Akhlq Husain
- 299 Novel bacteria for biological control of root-knot nematode, *Meloidogyne incognita* Rami Kassam 184
- 300 New record of Six-spot Ground Beetle *Anthia sexguttata* (Fabricius, 1775) (Coleoptera : Carabidae), a biological pest controller, from Jehanabad, Bihar (India) 184
Akhlq Husain¹ and Wajid Hasan²
- 301 Use of bacteria and fungi for control of soilborne seedling diseases of maize 185

3rd International Conference on “Global Initiative in Agricultural, Forestry and Applied Sciences for Food Security, Environmental Safety and Sustainable Development (GIAFAS-2021)”

	Rambabu Dasi*, L. Nongdrenkhomba Singh, Bireswar Sinha, Nabakishor Nongmaithem, Pavani Paluru, Pooja Reddy, Kota Chakrapani	
302	Biological control of tomato fruit borer, <i>Helicoverpa armigera</i> (Hubner) N. Sunita Devi, Takhellambam Julia and Rimamay Konjengbam	185
303	Discussion of some common fungal post harvest diseases of garlic in Manipur Rimamay Konjengbam*, N Sunita Devi, Takhellambam Julia and Kota Chakrapani	185
304	Effect of GA ₃ on flower yield and quality of different varieties of perennial Chrysanthemum Dipmala P. kedar*, Dipali Chatse, Dr. D. M. Panchbhai	186
305	Studies on insect pests of apple in Kashmir and its integrated management approaches Shabir Davood Wani, Mohd Majid Jamali*, Rayees Afzal Mir & Dil Mahjoora Majeed	186
306	Inference of Rock Phosphate, Phosphorous Solubilizing Bacteria and Lime on Phosphorous Content, uptake of P and Plant Dry Weight of Green Gram (<i>Vigna radiata</i> (L.) Wilczek) Nakeertha Venu*, N. Surbala Devi, Laishram Nikita Devi and Hiren das	186
307	Effect of liming on nodulation in acid soil Rupesh*, Jamkhogin Lhungdim, S. Mounika	187
308	Phytoremediation of heavy metals by <i>Eichhornia crassipes</i> Keisham Dony Devi, Th. Anupama Devi, L. Nabachandra Singh	187
309	Review: Post-Harvest Disease Management of Citrus using bio-control measure Mridupol Handique	188
310	Content of Zinc in Organic Sources as Influenced by Incubation of Zinc Sulphate Sangya Singh* ¹ , G.S. Tagore ¹ , Shubham Singh ²	188
311	Motorized groundnut stripper: A cost effective post harvest technology Rajeshwari Desai, Geeta Chitagubbi and Shobha Kasar	189
312	Popularization of agricultural technologies for drudgery reduction and farm profitability Rajeshwari Desai, Geeta Chitagubbi and Shobha Kasar	189
313	Evaluation of diverse wheat genotypes for heat stress tolerance using correlation and path coefficient analysis Kavita, Mukesh Kumar	190
314	Intregrated nutrient management Jay Nath Patel* ¹ , Mohd Shah Alam ¹ , Durgesh Kumar ²	190
315	Role of market access for food and nutrition security in India Subodh Agarwal	191
316	Effect of Post Harvest Technology in Increasing Shelf life of Rose (<i>Rosa hybrida</i>) cv. Mainu Parle Punam Horo*, Raimani Hembrom, Aruna Murmu and Arti Kumari	191
317	Impact of Microbial Consortia on Plant Attributes and Nodulation in Soybean Shubham Singh* ¹ , N.G. Mitra ² , R.K. Sahu ² , Sangya Singh ²	192
318	Effect of agronomic practices on green house gases emission in paddy field Saithala Mounika*, Edwin Luikham, Rupesh Ganjare	192
319	Recent advances in sustainable management of Maize Sheath Blight Paluru Pavani*, L. Nongdrenkhomba Singh, Bireswar Sinha, Nabakishor Nongmaithem, Rambabu Dasi, Pooja Bathula	193
320	Genetic assessment of newly developed maize inbreds for yield and its attributes in different agro-climatic conditions *Gaurav Sharma ¹ , Uttam Chandel ² , Sawan Kumar ¹ and Satish Kumar Guleria ³	193
321	Occupational health hazards of workers in small scale enterprises Kiran Bala & Wineet Chawla	194

322	Anatomical and physiological basis of resistance against downy mildew in pearl millet (<i>Pennisetum glaucum</i> (L.) R. Br.) Sarah Murria ^{1*} , Namarta Gupta ¹ , Nirmaljit Kaur ¹ , Ruchika Bhardwaj ² and Anju Bala ²	195
323	Biological Control of <i>Aphis craccivora</i> (Koch) with predaceous ladybird, <i>Hippodamia variegata</i> (Goeze) Pratibha Awasthi and Ahmad Pervez	195
324	Effect of heavy metal stress on photosynthesis and respiration of plant Manjulata Palei and Ranjan Kumar Sahoo*	196
325	Recent advancements for energy production and sustainable environment in anaerobic digestion technology P. S. Bandgar, Sudhir Jain and N. L. Panwar	196
326	Ergonomic Assessment of Occupational Hazards among Dentists of Uttarakhand: A Descriptive Study Garima Pant and Deepa Vinay	197
327	Moisture conservation for timely sowing of wheat in <i>rabi</i> season under rainfed conditions ¹ Vishal Sharma*, ² Arvind K. Ishar, ³ Suraj Parkash, ⁴ Parul Gupta, ⁵ Rohit Sharma ⁶ Ajay Gupta and ⁷ Vishal Mahajan	197
328	Influence of date of sowing on the development of Alternaria blight, 1000 seed weight and seed yield Oilseed Brassica C.S. Choudhary*, Md. Minnatullah ² , Anjana Arun ¹ , S. P. Singh ² , R.S. Singh, Vikram Bharati, A. K Mishra, U. Mukherjee and Anil Pandey	198
329	Assessment of elite and ISH genotypes for resistance to sugarcane red rot disease Md. Minnatullah ¹ , Shiva Pujan Singh ¹ , C.S. Choudhary ² , Anjana Arun ³ and Aaradhna ¹	198
330	Mapping of Soil Macro and Micro Nutrients by GIS in Jalgaon district (M.S.) ^{1*} Monika Naphade, ² G. S. Sidhu, ³ V. D. Patil, ⁴ Ritu Thakare	199
331	Determination of the Physiological effect of workers on linseed thresher Meera kumari	200
332	Soil organic carbon pools variability in the different agro-climatic conditions of Bihar Sunita Kumari Meena, Ajeet Kumar, Md. Minnatullah, Shiv Pujan Singh	200
333	Response of Early Sugarcane (<i>Saccharum officinarum</i> L.) Genotypes under varied NPK levels and row arrangement in subtropical climates of Bihar. Lalita Rana, Navnit Kumar and A.K.Singh	200
334	Use of ICT among Rural Farmers in Agricultural Development Kumari Shipra	201
335	Standardization of protocol for genomic DNA extraction in <i>Fraxinus xanthoxyloides</i> a cold desert species grown in Western Himalayas Akshit Kukreti ^{1*} , Manisha Thapliyal ² , Neelam Kurmanchali ^{3*} and Laxmi Rawat ⁴	201
336	Use of some organic and biofertilizers with partial substitution for the mineral fertilization of maize Huda M. M. Elmasry	202
337	Current conditions and impacts of climate change - Policies and ways to limit the impacts N.Meenakshi*, A.Srilatha and Renuka.S.Salunke	202
338	A review of the significance of microorganisms in bioremediation Akrati Dev, D.K. Dwivedi and N. A. Khan	203
339	Cytoplasmic genetic male- sterility system in pearl millet and exploitation of heterosis Naveen Sihag, Dev Vart Yadav	203

340	Chemical Composition and Utilization of Forest Fruits: A Review Kusum Meghwal ¹ , Deep P Patel ¹ , Jain SK ² , Arun K ³	204
341	Agriculture, Pesticides, Food Security and Food Safety Rohtash Kumar ¹ , Jasveer Singh ² and Pradeep Kumar ³	204
342	Food security in developing countries Sakshi Goyat	205
343	Evaluation of food grains for preparation of spawn for cultivation of <i>Calocybe indica</i> Dibakar Panda* and Mohan Kumar Biswas	205
344	Importance of Indigenous Technical Knowledge Naaz Bano, Neelam Kumari and Rajesh Dahiya	206
345	Attitude of farm women towards indigenous technical knowledge (itk) with emphasis on agriculture and allied fields Pritishri Parhi	206
346	Nanotechnology in crop protection Shivani Suman and Naveen	207
347	Impact and approach of Front Line Demonstration of Lentil (<i>Lens Culinaris</i> Medik.) Crop in Saran District, Bihar Surendra Prasad*, R. K. Jha, A. K. Singh, Vijay Kumar, Pankaj Kumar, S. S. Patel And J. C. Chandola	207
348	A study on exploration of soil quality of the agricultural soil of Ludhiana District, Punjab (India) Priyanka Sharma, Jatinder Kaur Katnoria	208
349	Therapeutic prospective of Broccoli (<i>Brassica oleracea</i>) – An overview Banu Nyori*, Suneeta Singh and Anil Kumar Saxena	209
350	New records of Tropical Leather-leaf Slug <i>Laevicaulis alte</i> (Ferussac, 1822) (Mollusca : Gastropoda : Systellommatophora : Veronicellidae) from Dehra Dun (Uttarakhand, India) and Jamshedpur (Jharkhand, India) Akhlq Husain ¹ and Hishmi Jamil Husain ²	209
351	Digital Agriculture Sharad Pandey, Gideon Synrem, Mohammad Faisal, Mamta and Vivek Singh	209
352	Response of Liquid Biofertilizer, Plant Geometry and Different Levels of Phosphorus on Growth and Yield of Green Gram (<i>Vigna radiata</i> L.) Schchida Nand Singh, Vikram Singh, Moinuddin, Manoj Shukla and Sharad Pandey	210
353	Nutraceutical analysis in faba bean (<i>Vicia faba</i>) on variability and yield S. K. Yadav*, H.L.Raiger, Ravi Kumar ¹ and N.K. Jajoriya	210
354	Response of nutrients on potato yield Amrendra Kumar	211
355	Isolation, characterization and management of bacterial wilt of potato caused by <i>R. solanacearum</i> through resistance inducer chemicals R. K. Ranjan, P. K. Jha and Bimla Rai	211
356	Innovative approaches in agriculture Tanweer Alam, Shivakumara M N Vinay kumar Choudhary and Ram Kumar Choudhary	212
357	Elephant foot yam [<i>Amorphophallus paeoniifolius</i>] diversification in vegetable crops A. Narayan*, R.S. Singh, R. Prasad and G.S. Giri	212
358	Biomimetic textiles: An innovative approach towards conserving the future Pratikhya Badanayak* and Jyoti V. Vastrad	213
359	Effect of Fertigation on Carnation cultivation under Polyhouse S.K.Nirala, R.Suresh and Sunil Kumar	213

360	Growth and Instability in Area, Production and Productivity of Coffee in Kodagu district and Karnataka state Thanuja P ^{1*} , G.L. Meena ² , Babita Kumari ³	214
361	Brown manuring based weed management practices in direct seeded Rice (<i>Oryza sativa</i> L.) Sandeep S N ¹ , S. Pazhanisamy ¹ , Vidyashree B S ² , S K Chaudhary ¹ and Dharminder ¹	214
362	Study of induced resistance in Brinjal (<i>Solanum melongena</i>) against Phomopsis blight (<i>Phomopsis vexans</i>): A Review Md. Shuja Ahmaed*, Adesh Kumar, Adarsh Sharma and Tammana Rana	214
363	Development and standardization of prebiotic nutri-bar S. Sucharitha, M. Akshay, I. Ramu and Prashanthi Meda*	215
364	Development and standardization of Quinoa based nutria-bar G Pravalika, G Srinidhi, G Vineeth kumar and Sushma Devi Rodda*	215
365	Microbial Enrichment of Organic Manures on Survivability of <i>Rhizobium</i> and Phosphate Solubilizing Bacteria in Organic Manures Sushma Devi Rodda and Subhash Reddy R	216
366	Effect of root-knot nematode, <i>Meloidogyne incognita</i> -wilt fungus, <i>Fusarium oxysporum</i> disease complex of Field Pea, <i>Pisum sativum</i> , and its management through integrated approach under field conditions Syed Abuzar	216
367	Brown Midrib Sorghum (<i>Sorghum Bicolor</i> (L.) Moench): Potential Source for Fodder Quality Improvement A.W. More*, D.B. Deosarkar, S.P. Mehtre and H.V. Kalpande	217
368	Variability studies in Rabi Sorghum (<i>Sorghum Bicolor</i> (L.) Moench) Germplasm Line for Drought Adaption More Ambika Kalpande H.V. and D.B. Deosarkar	217
369	Comparative Performance of Single-Cut Sorghum for Green Fodder Yield A.W. More*, K.R. Kamble and L.N. Jawale	218
370	Allele Mining: A Technique for Crop Improvement Prashant Gigaulia, Prakash Narayan Tiwari, Swapnil Sapre	218
371	Adoption of Millets instead of Paddy: Save Water Sneha Pandey	219
372	Effect of field and farm production system on biochemical parameters in chicken eggs from different breeds P K Maddheshiya ¹ , Nazim Ali ¹ , Mahesh Kumar Bharti ² , Ahmad Fahim ³ , R. A. Siddique ² , Rajbir Singh ¹ , and D S Sahu ¹	219
373	Agonists induced Acrosome Reaction in Buffalo Spermatozoa Siddique R.A. ^{1*} , Atreja S. ² , Khan M.A. ¹ , Singh K. P. ³ , Fahim A. ¹ and Ali N. ¹	220
374	Effect of supplementation of <i>Agaricus bisporus</i> and <i>Saccharomyces cerevisiae</i> on hematological, biochemical parameters vis-a-vis growth performances in broiler chickens Raj Kumar ^{1*} , Nazim Ali ² , R. A. Siddique ² , D. S. Sahu ² , Ahmad Fahim ² and Rajbir Singh ⁶	220
375	Nanotoxicity impact and challenge for livestock Deepika Chandra, Mahesh Kumar Bharti, R. A. Siddique, K. Ranjan, and Pankaj Kumar	221
376	A need for adoption of climate resilient varieties of sugarcane under sub-tropical condition Himanshu Rai and Nenavath Krishna Kumar Rathod	221
377	Impact of rhizobium on growth, biomass accumulation and nodulation in <i>Albizia Procera</i> Seedlings from Himachal Pradesh Arti Ghabr and Neerja Rana	222

378	Study on allelopathic aqueous extract of <i>Eupatorium adenophorum</i> for the management of <i>Parthenium hysterophorus</i> L. in lower temperate region of Tehri Garhwal Himalaya, Uttarakhand, India. Vivek Kumar* B. S. Bisht	222
379	Physical characteristics and nutritional properties of honey obtained from rubber and moringa flora Keerthana, B., R. Kanagarajan, K. Nishanthini, B. Anujaa, M. Vikaash, K. Hari Chandana	222
380	Metabolite profiling of underutilized legumes winged bean <i>Psophocarpus tetragonolobus</i> (L.)DC for sustainable development Kunwar Sarvendra ¹ , Chandra Sekhar Mohanty ¹ , SC sati ²	223
381	Combining ability and heterosis studies for agro-morphological and yield traits in hulled barley (<i>Hordeum vulgare</i> L.) under north-western Himalayan conditions Chetan Gupta*, Vijay Rana, Amit Rana and Priyanka	223
382	Doubling the farmers income through innovative approaches Meenakshi attri, Lalicheti Sagar, Monika Menia, Jyoti Sharma and Swati Mehta	224
383	Chemical weed control in Maize (<i>Zea mays</i> L.). A review M.S Na Allah, Gurpreet Singh and Sandeep Menon	224
384	Ethno-botanical Diversity of Wild Edible Fruits of Central Manipur–An overview Wahengbam Uniqueson Singh*, Suneeta Singh and Anil Kumar Saxena	225
385	Basketry production from bamboo by rural women in Kalka region (Haryana) Lalita Rani ¹ and Nisha Arya ²	225
386	Value Addition of Fruits and Vegetables: Challenges and Opportunities Ritu Pandey and Sharad Pandey	226
387	Role of Information Communication Technologies (ICTs) in Dairy Farming Management Pooja Karki and Mohammad Aslam Ansari	226
388	Productivity of quality fodder of oat as influenced by integrated nutrient management techniques Manpreet Kour ^{1*} , B. C. Sharma ¹ , A. K. Dixit ² , N.P.Thakur ³ , Rohit Sharma ⁴ and Parshotam Kumar ³	227
389	Agronomical strategies for year round fodder production and conservation of surplus fodder for dairy animals under North-west Himalayas Manpreet Kour, Rajeev Singh, B.C.Sharma, N.P.Thakur , Suheel Ahmad, Sheeraz S. Bhat and Rohit Sharma	227
390	Organic farming with residue-free production Neeraj Kumar	227
391	To study the decision-making behavior of farmer and farm women in management activities in Kadapa district of Andhra Pradesh, India P. Laxmi Prasanna, B.P. Mohapatra R.K. Mishra	228
392	Smart Farming: The Future of Agriculture Mamta Patel ¹ , Sneha Pandey ² and Sanjana Sharivastava ³	228
393	Expression Dynamics of MRP genes during peri-impantation period in Buffaloes Rajni Kumari, Rakesh Kumar*, S Dayal, Rohan Raman, PC Chandran, PK Ray, A Dey, Kamal Sarma	229
394	Effect of Electromagnetic Radiation (1800 MHz) on Germination Percentage, Morphological Characteristics, Lipid Peroxidation and Antioxidant System in <i>Trigonella foenum-graecum</i> Test System Surbhi Sharma ¹ , Shalini Bahel ² and Jatinder Kaur katnoria ^{1*}	229

395	Development and nutritional evaluation of β -carotene rich <i>Idli</i> prepared using <i>curry leaves</i> powder Sonia*, Varsha Rani and Sangeeta C. Sindhu	230
396	Pharmaceutical Potential of <i>Cordia macleodii</i> Hook F. Thomson and <i>Soymida febrifuga</i> (Roxb) A. Juss and its Conservation Strategies Anish Kumar Singh, K.K. Chandra	230
397	Growth and Yield Performance Analysis of Long Day Garlic Genotypes at High Altitude of Uttarkhand Raj Narayan ¹ , Sovan Debnath ² , Arun Kishor, ² D.B. Singh, ³ O.C. Sharma, ³ and S.K. Singh ¹	231
398	Assessment of Horticultural Technologies in Kumaon Hills of Uttarkhand for Sustaining Himalayan Ecosystem Raj Narayan ¹ , Arun Kishor, ² Sovan Debnath ² , D.B. Singh ³ , O.C. Sharma, ³ Anil Kumar ⁴ and S.K. Singh ¹	231
399	Antifungal activity of some aqueous plant extracts on Leaf blight of Taro caused by <i>Phytophthora colocasiae</i> Sukanya Gogoi*, Popy Bora and Mallikarjun Channappa Chitti	233
400	Bioremediation and Water Pollution – A review *Prajna Samal, Bireswar Sinha, Soumen Pati	233
401	Evaluation of Different Pruning Intensities in Plum (<i>Prunus domestica</i>) at Dehradun Valley of Uttarakhand Ashish Paul ¹ , Suneeta Singh ² and Anil Kumar Saxena ³	234
402	Role of Non-Timber Forest Products (NTFPs) Supporting Healthcare and livelihood in Gurez Valley of Northwestern Himalayas Ummar Atta*, M.A Islam, S.A Gangoo, Amerjeet Singh and F.A Shah Khan	234
403	Weather Yield Forecast Models of Mustard for Different Districts of Western Uttar Pradesh. Snehdeep ¹ , Yogesh Kumar ¹ , S.P.Singh ¹ , R.K.Naresh ² , Ashok Kumar ¹ , K.K.Singh ³	235
404	<i>In vitro</i> callus induction and cell suspension studies in <i>Catharanthus roseus</i> (L.) G. Don Pallavi Sati*, Vaishali Chandola*, Monali Chauhan, Sonam Rawat, A R Nautiyal	235
405	Effect of Pruning Intensity in Apple (<i>Malus domestica</i>) Under Lower Hills of Uttarakhand Zahid Rehman ¹ *, Suneeta Singh ² and Anil Kumar Saxena ³	235
406	Biogenic Synthesis of Potassium Nanoparticles for Evaluation as Nanofertilizer in Wheat Sapna Grewal * ¹ , Promila Sheoran ¹ , Santosh Kumari ¹ , Sonia Goel ²	236
407	Development and Evaluation of Self-propelled Potato Digger Neeraj Singh Parihar, Sushil Sharma, Sanjay Khar and J.P. Singh	236
408	Agroforestry: A Suitable option to increase farmer’s income in Jabalpur region of Madhya Pradesh Parul Sharga, S.D Upadhyaya, D.V.Bhagat	236
409	Artificial diet for laboratory rearing of <i>Acanthophorous serraticornis</i> (Olivier) <i>Prosopis cineraria</i> (L.) Druce (Khejri) root borer Shiwani Bhatnagar*, Sangeeta Singh, Ameen Ullah Khan, Bundesh Kumar, Parveen Goran, Vineeta Srivastav, Bindu Nirwan and Lokendra Singh Rathore	237
410	Marwar teak defoliator <i>Patialus tecomella</i> (coleoptera: curculionidae) infestation on <i>Tecomella undulata</i> (Sm.) Seem. (Rohida) in Rajasthan Shiwani Bhatnagar*, Neha Sharma, Raj kumar Suman, Mamta Sankhla, Ameen Ullah Khan, Sangeeta Singh and Tanmay Boi	237
411	Bioremediation of soil persistent pesticides by microbes: A novel approach for pesticide waste management	238

	Shiwani Bhatnagar and Desha meena	
412	Therapeutic Potential and Antioxidant Activity of <i>Piper Betle L.</i> Renuka Jandu and Varsha Rani	238
413	Investigation of phytochemicals and antimicrobial activity of Tulsi (<i>Ocimum sanctum L.</i>) Ankit Agrawal and Pankaj Chauhan	239
414	Compilation of Chilli Indigenous knowledge Practices in Sikkim State Smriti Subba, Anindita Saha & Ravi Kumar Gupta	239
415	Effect of Salt stress on Biomass, Biochemical Parameters & Yield of Soyabean (“Glycine max.(L.)Merril”) Gulafshan & Farha Rehman	240
416	Diversity and Functionality of Seed Vectored Bacterial Endophytes in <i>Triticum aestivum L.</i> across Boundaries of Cultivars and Ecology Jogdande Sai Prasad, Archana Suman	240
417	Bio-chemical Studies of Kalmegh (<i>Andrographis peniculata</i> Burn F. Ex) with Particular Reference to Impact of Growth Hormones D.K. Raidas	240
418	Genetic Diversity in Bread Wheat (<i>Triticum aestivum L.</i>) for Morpho-physiological Traits and Grain Micronutrient Content Mainak Barman*, Vinay Kumar Choudhary, Satish Kumar Singh	241
419	A study on seed replacement rate of paddy in Chandauli district of Uttar Pradesh Mohit Kumar Gupta ^{1*} , Kalyan Ghadei ² and Gyan Shukla ³	241
420	Physico-chemical composition of different genotypes and varieties of Aonla (<i>Emblica officinalis</i> Gaertn.). Jitendra Chandravanshi, Eeshwar Sahu, Pratibha and D.P. Sharma,	242
421	Characterization of different genotypes of Aonla (<i>Emblica officinalis</i> Gaertn) developed in JNKVV Jabalpur (M.P.) Jitendra Chandravanshi, Brajesh Dhakad, Kanta Sahu and A. K. Singh	242
422	Physico-chemical study of Aonla genotypes (<i>Emblica officinalis</i> Gaertn) Jitendra Chandravanshi, Eeshwar Sahu, Rohit Singh and D.P. Sharma	242
423	Effect of Organic Manure and Corresponding Humic Acid on Nitrogen Transformation and Yield of Chickpea Grown in an Acid Soil Nongthombam Surbala Devi, Geeta Nongmeikapam, T. Sanahanbi Devi, Nakeertha Venu and L.Nikita Devi	243
424	“Cost effective bioprocess for anti-viral bioactive production through microbial transformation” Sugandha Mishra ¹ Dhirendra Kumar ^{2,3*} , Dharmendra Jain ⁴ Amit Kumar dutta ⁵	243
425	Utilisation of Food Industry Waste for Value Addition of Food Products Development Ashwini N Bellary	244
426	In-silico assessment of Biphenyl Dioxygenase activity from <i>Pandoraea Pnomenusa</i> B-356 with different PCBs congeners	244
427	Digitization of traditional ‘Kutch and Kathiawar embroidery motifs’ and access their marketability Sarita Devi ^{1*} , Sushila ² and Nisha Arya ³	244
428	System of ragi intensification as an emerging SRI *S. Pazhanisamy ¹ , Rodda Chandana Devi ² , Vijayakumar ³ and S.N. Sandeep ⁴	245
429	Combining ability and heterosis studies for agro-morphological and yield traits in hulled barley (<i>Hordeum vulgare L.</i>) under north-western Himalayan conditions Chetan Gupta ^{1*} , Vijay Rana ^{1,2} , Amit Rana ¹ and Priyanka ¹	245

430	Effect of different spacings of poplar on growth, yield attributing traits and fodder yield of cowpea under silvi-pastoral system *Sneh Yadav, R. S. Dhillon and J.S.Ranawat	246
431	Role of Genetics & Plant Breeding In Maintaining Positive Relationship Between Food Security, Environmental Safety & Sustainable Development. Nishtha* ¹ , Shanza Baig ² & Akash Shukla ³	246
432	Genetic diversity in <i>Bipolaris maydis</i> isolates inciting maydis leaf blight of maize Manjeet Singh* and Rakesh Mehra	247
433	Epidemiology of maydis leaf blight of maize caused by <i>Bipolaris maydis</i> (Nisikado and Miyake) Shoemaker in relation to weather parameters Manjeet Singh* and Rakesh Mehra	247
434	Effect of root dip treatment of onion seedlings for the management of <i>Thrips tabaci</i> Rabiya Basri ¹ * and M. Shafiq Ansari ²	248
435	Water conservation behaviour among farmers of Thoothukudi district R. Rajasekaran ¹ * and N. Dhivya ²	248
436	Impact of pandemic covid-19 on farming sector and farmer's livelihood in Salem district R. Rajasekaran ¹ * and N. Dhivya ²	248
437	Gene targeting in crop plants: by insert, remove or replace using advanced site-specific engineered nucleases Ruchi Agarwal*, Rima Kumari and V. K. Sharma	249
438	To evaluation of leaf color chart for need-based nitrogen management in rice crop in Gwalior district of M.P. Shaillesh Kumar Singh, Rupendra Kumar Singh, Anil Kumar Singh and R. K. S. Tomar	249
439	Cultivation & Choice of Rabi Vegetables for Homestead Nutritional Gardens in Dibrugarh District of Assam Dhiraj Bhattacharjee, Archita Ojah	250
440	Studies on the tolerance potential of <i>Eisenia fetida</i> towards Low density polyethylene microplastics Deachen Angmo ¹ , Rahil Dutta ¹ , Jaswinder Singh ² , Adarsh Pal Vig ¹ *	250
441	Record on egg parasitoids of the family Trichogrammatidae (Hymenoptera: Chalcidoidea) from Chhattisgarh, India ¹ Mohsin Ikram*, ² Rajendra Prasad, ³ Mahipal Singh, ⁴ Salman Khan, ⁵ Manendra Kaneria, ⁶ Manish Kaneria	251
442	Assessment of adopted roof top rain water harvesting systems: A case study in Dharwad district of Karnataka state Jeevitha K. M and Veena S. Jadhav	251
443	Record of the genus <i>Pseudoshirakia</i> achterberg (insecta:hymenoptera:braconidae) from India, with description of one new species Arshad Ali Haider	252
444	Effects of grazing herbivore on grasshopper population and nature on Indian vegetations Md. Humayoon Akhtar ¹ and Manish Bhardwaj ²	252
445	Rapid Assessment of Butterfly Diversity in Rajgir Wildlife Sanctuary, Bihar, India Manish Bhardwaj* ¹ and Md. Humayoon Akhtar ²	253
446	Improved biomass stoves in rural area -a boon Renuka S. Salunke and Dr.S.S.Dolli	253
447	Detection of Flow of Seeds in the Seed Delivery Tube and Checking Status of Seed Delivery Tube of a Seed Drill Raushan Kumar*, Rajat Arya, Arun Kumar	254
448	<i>Ananas comosus</i> Peel: A Potential Phytoremedy towards Cancer	254

	Shashi Soni and Ena Gupta	
449	Effect of germination on nutritional and anti-nutritional components of Adzuki bean Qurat Ul Eain Hyder Rizvi*, Krishan Kumar, Priyanka Thakur, Divya Chauhan, Naseer Ahmed	254
450	Management of brinjal fruit rot caused by <i>Phomopsis vexans</i> Sheetal Dhariwal* and Pooja Sangwan	255
451	Role of AMMI and GGE biplot in development of new varieties in changing climatic conditions Atul Loyal ¹ , Naval Kishore ² S. K. Pahuja ¹	255
452	Comparative genomics and it's significance in crop improvement Alka Soharu and Navdeep Kaur	256
453	Standardization, Mass production and evaluation of N-fixing and phosphate solubilising biofertilizers using indigenous bacterial strains from rice rhizosphere in Jammu district Renu Gupta*	256
454	Backyard Poultry Management Practices in Tribal Area of Dungarpur District of Rajasthan Budharam*, Hitesh Muwal**, Vinod Bhatেশwar***	257
455	Bioremediation of thiamethoxam contaminated soils by <i>Bacillus pumilus</i> isolated from soil Rozy Rasool*, Balpreet Kaur Kang	257
456	Removal of cadmium (II) ion from aqueous solution using <i>Melia azedarach</i> twig charcoal powder Joat Singh and Jatinder Kaur Katnoria*	258
457	Assessment of weed management practices on productivity and economics of Pigeonpea Vinod Kumar ¹ , Ashok Kumar ¹ , Mukesh Kumar ¹ , Rita Lal ¹ and Shashank Tyagi ²	258
458	Childcare among agricultural labourer households - problems and strategies to overcome them Dibyapraava Pradhan	259
459	Influence of PGRs and planting geometry on growth, yield & quality of gladiolus (<i>G. grandifloras</i> L.) Khiromani Nag ¹ and Abhishek Singh ²	259
460	Improving floral attributes in orchid through genetic engineering Khiromani Nag ¹ , Gloriya Smitta Kispotta ² and Jogendra Kumar ³	260
461	Bioinformatics in agriculture G. Prasanna and L. Krishna	260
462	Barbara McClintock's Concept on mutable loci in maize: A Review Pooja Kanwar Shekhawat*, M. L. Jakhar ¹ , Anita ² , Nikki Kumari ³	260
463	Ergonomical evaluation of harvesting by serrated sickle Amita Gautam and S.V. Jogdand	261
464	Carbon sequestration potential of <i>Grewia oppositifolia</i> based traditional Agroforestry system in Garhwal Himalayan region of India Naveen Tariyal ^{1*} , Arvind Bijalwan ¹ , Bhupendra Singh Butola ¹ , Sumit Chaudhary ² , Aalok G.Yewale ³ and Shikha ³	262
465	Identifying of Resistant and Susceptibility of Manipur Paddy Cultivars to Angoumois Grain Moth, <i>Sitotroga cerealella</i> (Olivier) Nisanam Nagaraju ¹ , Nilima Karam ^{1*} , K.I. Singh ¹ , Gulappa Chandra Sekar ¹ , N. Gopimohan Singh ²	262
466	Design of separator for tractor drawn onion digger	263

	Amita Gautam ¹ , S.V. Jogdand ² , R.K. Naik ³ , Pushpraj Diwan ¹ and Smita Gautam ⁴	
467	Development of two row power weeder for wet land paddy and comparative evaluation with existing weeding methods Pushpraj Diwan ¹ , Prabhat Kumar Guru ² , Rajesh Kumar Naik ³ , Nenavath Manikyam ¹ and Amita Gautam ¹	263
468	Heavy Metal Analysis and Health Risk Assessment of Soil under Rice Cultivation of Batala Region of Punjab (India) Neeru Bala ¹ , Yogesh B. Pakade ² and Jatinder Kaur Katnoria ^{1*}	263
469	Benefits Perceived by the Students regarding E-learning during COVID-19 Pandemic Rupanshi Yadav ¹ and Prakash Panwar ²	264
470	Effect of different cereals grain extract media on mycelial growth of <i>Pleurotus</i> spp. (<i>P. Sapidus</i> and <i>P. Flabellatus</i>) Sandeep Kumar ^{1*} , Gopal Singh ² , Ramji Singh ² Popin Kumar ² and Rajendra Prasad ²	265
471	Green synthesis of thiophene-2-carboxalehdye azomethines and their antifungal evaluation Sukhmanpreet kaur ¹ , Sunita sharma ² , Tanvi sahani ¹ , Diksha verma ¹ , Amanpreet kaur ¹	265
472	Effect of different carrier agents on freeze dried button mushroom: a review Rafeeya Shams*, Jagmohan Singh	265
473	meta-Topolin mediated in vitro regeneration of <i>Crinum</i> species Swati Chahal and Harmeet Kaur	266
474	The use of gunny waste fiber as complement in handmade paper production for a sustainable environment Shobha Huilgol and Veena S Jadhav	266
475	Studies of Pusa Hydrogel application on yield and productivity of Wheat under limited irrigation conditions in Nimar Region of Madhya Pradesh Y.K.Shukla and Rashmi Shukla	267
476	Evaluation of phytopharmacological attributes and important secondary metabolites from <i>Tridax procumbens</i> L. Aditi Arya, Sonia Goel ¹ and Sapna Grewal ²	267
477	Mitotoxic potentiality of copper sulphate on <i>Allium Cepa</i> Naina srivastava	268
478	Antifungal properties of <i>pterocarpus santalinus</i> bark Rakesh Kumar ^{1*} , A Muthu Kumar ² , Souvik Ray ¹ , S.R. Shukla ³ , S.S. Bisht ³	268
479	Nanosized Titania Based Heterogeneous Catalyst: An efficient nanocatalytic system in Click reaction Neha Sharma*, Monika Gupta, Bushra Chowhan, Mobina Kouser	268
480	Traditional use of non- timber forest products: Boon for livelihood security of people in Shivalik range of Jammu region Yudhishter Singh Bagal* and Stanzin Yangsdon	269
481	Influence of different levels of sulphur and biofertilizers on soil properties and yield of mulched Groundnut (<i>Arachis hypogaea</i> L.) in lateritic soils of Konkan region Jadhav S. C., Salvi V. G., Kasture M. C., More S. S. and A. A. Walekar	269
482	Effect of iron, zinc and boron on growth, yield, quality and storability of onion (<i>Allium cepa</i> l.) Cv. Agrifound light red S. G. MORE* and L. R. VARMA	270
483	Development and optimization of semi-automated hot air puffing system for millets Surpam, T. B. ¹ , Pardeshi, I. L. ² and Rokade, H. N. ³	271

484	Growth performance of gir heifer on feeding of jowar straw in combination with soybean straw Dr. S. D. Chavan, Dr. S. P. Nage, Dr. S. R. Shegokar	271
485	Soil quality assessment of rural and peri-urban areas of southern transect of Bengaluru (Principal component analysis) Altaf kuntoji ¹ , Subbarayappa C. T. ¹ , Chamegowda T. C. ¹ , Sathish A. ¹ , Ramamurthy V. ¹ and Mallesha B. C. ²	272
486	Plasma technology in Agriculture Shivani Kumari ^{1*} , Lanunola Tzudir ¹ , Sushilkumar S. ¹ , Meshram, M. R. ² , Lalit Kumar Sanodiya ²	272
487	Studies on shrikhand blended with guava (<i>Psidium guajava</i> L.) Pulp S. P. Nage, S. D. Chavan, S. R. Shegokar, R. D. Dhage	272
488	To study the effect of different packaging material on apple ber candy over different storage periods S.R.Gavali, D.N.Vishwasaneand and S.J. Veer	273
489	Haematological Indices of Vanraja Poultry Birds Fed Aloe vera (<i>Aloe barbadensis</i>) and Neem (<i>Azadirachta indica</i>) Leaves Powder S. D. Gadekar*, S. D. Chavan and S. P. Nage	273
490	An era of plant breeding in india: molecular breeding Ruchi Bishnoi ¹ and Akash Barela ²	274
491	Nutritional Gardening: A way to achieve Food and Nutritional security in rural areas of Jammu (J&K) Poonam Abrol	274
492	Molecular breeding for the development of hybrid onion Hira Singh, Anil Khar, Masochon Zimik and Priyanka Verma	275
493	Impact of Gibberellic Acid on Growth and Flowering Parameters of African Marigold (<i>Tagetes erecta</i> L.) cv. Pusa Basanti Gainda in Western Plain Zone of U.P. Toryalay Bajawri, Sunil Malik, Mukesh Kumar, S.K. Tirpathi, Ravindra Kumar and Bhim Singh	275
494	Production Potential and Economic Viability of Buckwheat (<i>Fagopyrum esculentum</i>) as influenced by Integrated Nutrient Management in Northern Hill Region of Chhattisgarh Sandeep Sharma*, C.P. Rahangdale, P.K. Lakra, S.C. Pankaj, S.P. Gupta and Pushpendra Singh	276
495	Efficacy of azoxystrobin + difenoconazole against <i>colletotrichum falcatum</i> w. Causing red rot in sugarcane Mohd Irshad*, Anwar Ahmad, Dr. Sujeet Pratap singh, Dr. Ajay kumar	276
496	Assessment of genetic variability, heritability, genetic advance, character association and path coefficient for grain yield and its attributing traits in wheat (<i>triticum aestivum</i> l. Em. Thell) in eastern uttar pradesh Mithilesh Kumar Chaurasiya ¹ , Tarkeshwar ^{2*} , Kamlesh Kumar ¹ , Soni Singh ² and S.C. Gaur ¹	277
497	Generation of multiparent advanced generation intercrossed (magic) population and their utilization in crop improvement Kamlesh Kumar ¹ , Tarkeshwar ² , Soni Singh ² and Govind Mishra ²	277
498	Bioprospecting and endophytic fungal assemblages of mangrove plant <i>Avicennia marina</i> Thirumalesh B.V.*	278
499	Progress and Potential of Horticulture Sector in India Akshay Deep, Sudhakar Dwivedi, Anil Bhat, Lalit Upadhyay, Manmohan Lal	279

500	Front line demonstrations on pigeon pea to enhance the production and minimize the yield gap Mamta Singh ¹ , A K Singh ² and KS Yadav ¹	279
501	Human gut microbiota and its role in immunity Sneahpreet Kour, Upma Dutta, Brajeshwar Singh, Ashish Sheera	280
502	Factors Affecting Perceived Training Need of Horticulture Extension personnel in Jammu Region of J&K Arvinder Kumar, S.K Kher*, Lalit Upadhyay, Lobzang Stanzen, Preety Chaudhary	280
503	Pattern of Livelihood Diversification of Households in India Diksha, Sudhakar Dwivedi, Jyoti Kachroo, Akshaydeep	281
504	Evaluation of different IPM modules against fruit borer, (<i>deudorix isocrates</i>) on aonla (<i>emblica officinalis</i>) Thanlass Norboo*, Uma Shankar, Stanzin Landol, Lalit Upadhyay and Divya Chand	281
505	Current Status of Plant Genome Editing Preeti Choudhary, Prerna Johar ¹ , Lalit Upadhyay, Arvinder Kumar, Lobzang Stanzen	282
506	Study on pest and disease incidence in tomato under poplar based agroforestry in subtropics of Jammu Lalit Upadhyay, S. K. Gupta, Sandeep sehgal, Uma Shankar*, Amit Singh*	282
507	Economic analysis of Kharif vegetables under poplar based agroforestry in subtropics of Jammu Lalit Upadhyay ² , S. K. Gupta, Sandeep sehgal, Suresh Ramanan S. ¹ , Arvinder Kumar ²	283
508	Importance of feed and fodder for enhancing milk production Moh Faiz* Moh.Rizwan, Moh. Imran, Ahmad Fahim* and Nazim Ali	283
509	Entrepreneurship Development among Farmers Jamyang Lahmo* and Stanzin Yangsdon	284
510	Precision farming: Shifting from the conventional farming system Daripalli Srilakshmi, Subhendu Shekhar Gantait	284
511	Antagonistic performance of <i>Trichoderma spp.</i> against <i>Colletotrichum falcatum</i> causing red rot in sugarcane Jayant Mandal ¹ , Anwar Ahmad ¹ , Ajay Kumar ¹ and Sujeet Pratap Singh ²	284
512	Efficacy of azoxystrobin + difenoconazole against <i>Colletotrichum falcatum w.</i> causing red rot in sugarcane Mohd Irshad ¹ , Anwar Ahmad ¹ , Ajay Kumar ¹ and Sujeet Pratap Singh ²	285
513	Effect of different soil management practices and nitrogen levels on hydrothermal regimes in pea and okra crop in mid hill zone of Himachal Pradesh Sunil Kumar and M. L Verma	286
514	Yield gap analysis through cluster frontline demonstrations in groundnut in Nalgonda district, Telangana state Shankar, M. ^{1*} , Aariff Khan, M.A ¹ , Bharath, T ¹ , Pallavi, S ¹ , Shankaraiah, M ¹ and Sumalini, K. ²	286
515	Teff- a super millet crop Ashoka P*, Mahantesh B. Nagangoudar and Sunitha N H	286
516	Impact of Organic Agriculture as a Climate Change Mitigation Strategy Ashoka P, Mahantesh B. Nagangoudar and Priya P	287
517	Fertigation-A Tool for efficient fertilizer and water management in crops Ashoka P*, Priya P. and Mahantesh B. Nagangoudar	287
518	Micro irrigation Technologies for Contribute to Water Productivity and yield production in Indian Agriculture Ashoka P*, Priya P and Mahantesh B. Nagangoudar	288
519	A comparative study on long term use of various nutrient sources and its effect on soil health and crop production in different cropping systems: A review	288

3rd International Conference on “Global Initiative in Agricultural, Forestry and Applied Sciences for Food Security, Environmental Safety and Sustainable Development (GIAFAS-2021)”

	Rewangini Ranjha, Sunil Kumar, Rajpaul Sharma and Naveen Datt	
520	A Study on Impact of family size on Nutritional Status of Primary School Children Ankita Tyagi	289
521	Biofertilizer and their effects on quality of human life Khushboo Dubey	289
522	Fungicides and their effects on quality of human life Khushboo Dubey	290
523	Nutritional and Pharmacological Properties of Underutilized Fruit <i>Grewia asiatica</i> Ena Gupta ¹ and Neelesh Kumar Maurya ²	290
524	Review of Sesame’s Nutraceutical Importance Pinki Singh ¹ and Neelesh Kumar Maurya ²	290
525	Prevalence of eating disorder in adolescent girls Pooja Devi and Pratibha Arya	291
526	Bioactive compounds in fruits and their health benefits Latika Yadav ¹ and Neelesh Kumar Maurya ²	291
527	GIS approach in mapping potential upland fisheries resources of Anjaw district in Eastern himalay Deepjyoti Baruah ^{1*} , P.A. Ahmad ² , Ravindra Posti ² , Kishor Kunal ² , Garima ² and P.K. Pandey ²	292
528	Conservation of natural resources and their management through tribal women participation in protected areas of central India Poonam Xess and Garima Tiwari	292
529	Impact of Krishi Vigyan Kendra Dehradun on Women Empowerment: A Study Kiran pant, A. K. Sharma, Pravin Kumar	293
530	Effect of Pruning Intensity in Apple (<i>Malus domestica</i>) Under Lower Hills of Uttarakhand Zahid Rehman ^{1*} , Dr Suneeta Singh ¹ and Dr Anil Kumar Saxena ²	293
531	Impact and approach of front line demonstration of Lentil (<i>Lens culinaris medik.</i>) Crop in Saran district, Bihar Surendra Prasad*, R. K. Jha, A. K. Singh, Vijay Kumar, Pankaj Kumar, S. S. Patel And J. C. Chandola	293
532	Effect of irrigation scheduling on yield and water use efficiency on brinjal (<i>Solanum melongena</i>) under drip system Ram Kumar ¹ , P V Singh ² and Richa khanna ¹	294
533	Mycoremediation through dual high-efficient absorptive removal and degradation of benzidine-based carcinogenic Congo red dye containing wastewater by <i>Penicillium crustosum</i> PWWS-6 Barkha Sharma*, Shalini Tiwari, Lakshmi Tewari	294
534	Effect of indigenous microbial population upon degradation of profenofos, cypermethrin and chlorpyrifos and yield of rice Harshita Singh, Anita Sharma and MC Singh ¹	295
535	Improved fruit retention and yield by exogenous application of chemicals in mango (<i>Mangifera indica</i> L.) cv. Kesar Anshul S. Lohakare*, V.N. Shinde, M. Jyothi and T.B. Tambe	295
536	Effects of herbicides on weed dry matter and yield of wheat under zero-till condition S. S. Yadav	295
537	Genetic variants of POU1F1 Gene and their association with litter size and growth traits in Assam Hill goats Rakesh Kumar, Sourabh Deori, G. Khargharia, G. Kadirvel, Sunil Doley, Meena Das, Rajni Kumari*, K. K. Baruah and V.K.Mishra	296

538	Sexual dimorphism in <i>Myrica esculenta</i> Buch.-Ham. ex D. Don Vijay Laxmi Trivedi and Mohan Chandra Nautiyal	296
539	Innovations in Extension for Doubling Farmers Income Peddi Naga Harsha Vardhan and Deepa Roy	297
540	Impact of integrated nutrient management on growth attributes of okra [<i>Abelmoschus esculentus</i> (L.) Moench] Cv. Arka Anamika B. Maruthi ^{1*} , Dr. M. Hanuman Nayak ² , Dr. A. Kiran Kumar ² and Dr. D. Vijaya ³	297
541	Exploration of Different Strategies in Integrated Sheath Blight Disease Management for Rice Mat Nursery Yeluru Mohan Babu ¹ , Susmita Jha ² , Sekhar Bandyopadhyay ² , P. M. Bhattacharya ² and Apurba kumar chowdhury ²	297
542	Contribution of edible insects for the food and feed security Tumma Mounika*, Tapan Kumar Hath	298
543	Standardization of Integrated Nutrient Management for Growth and Yield of Tomato Eggadi Ramesh* and Subhamoy Sikder	299
544	Progress and prospects of genome sequencing of Garden pea (<i>Pisum sativum</i>) P. Shiva Kishore ^{1*} , Saikat Gantait ¹ , Sujaya Dewanjee ¹ and Suwendu Kumar Roy ²	299
545	Precision farming: Shifting from the conventional farming system Daripalli Srilakshmi and Subhendu Shekhar Gantait	299
546	Cold plasma technique expanding its wings with the combination of other technologies in food preservation Srujana Eda*, Prodyut Kumar Paul	300
547	Conventional control measures against Rugose spiraling whitefly, <i>Aleurodicus Rugioperculatus</i> Martin (Hemiptera: Aleyrodidae) in Godavari districts, Andhra Pradesh S. Sushmitha*, A. Sujatha	300
548	Effect of herbal edible coating to extend the shelf life of banana var. Ney poovan stored at room temperature Venkatesan.S* and M. Chitra	301
549	<i>Punica granatum</i> peel as a sustainable source for the prevention hypertension Uroosa Noor and Ena Gupta	301
550	Role of minor forest produces in sustainable development Damini Sharma	301
551	Effect of temperature and pH level on the growth of bacterial wilt causing <i>Ralstonia solanacearum</i> bacteria under <i>in vitro</i> conditions R. R. Bhanwar	302
552	Pattern of Livelihood Diversification of Households in India Diksha, Sudhakar Dwivedi, Jyoti Kachroo, Akshaydeep	302
553	Allelopathic effect of <i>Cymbopogon nardus</i> on <i>Eupatorium adenophorum</i> Sonam Rawat*, Monali Chauhan, Pallavi sati, Sudeep Chandra, M.C. Nautiyal	303
554	Correlation coefficient and Path analysis for seed yield and its attributing traits in Niger [<i>Guizotia abyssinica</i> (L. f.) Cass.] J.L. Salam and Kusumlata baghel	303
555	Changes in Structural Characteristics of Humic acid in soils having different nutrient management practices as revealed by spectroscopic techniques Priya Saini ¹ , Abir Dey ² and Mahesh C. Meena ²	303
556	Tolerance of <i>Eisenia fetida</i> towards herbicide (metsulfuron-methyl) Anu Bala Chowdhary ^{1*} , Jahangeer Quadar ¹ , Sharanpreet Singh ¹ , Jaswinder Singh ² , Adarsh Pal Vig ¹	304

557	Effect of germination on nutritional and anti-nutritional components of Adzuki bean Qurat Ul Eain Hyder Rizvi*, Krishan Kumar, Priyanka Thakur, Divya Chauhan, Naseer Ahmed	304
558	Response of different temperature and media on growth and sporulation of entomopathogenic fungi Vinod K. Nirmalkar* ¹ , N. Lakpale ² and R.K.S. Tiwari ¹	305
559	Impact of Citrus based agroforestry systems on above ground, below ground biomass and carbon sequestration Aarti P Deshmukh, Lalji Singh, V. M. Ilorkar and P. D. Raut	305
560	Current status of Maydis Leaf Blight of Maize in India – A Review Bathula Pooja*, Ph Sobita devi, Bireswar Sinha, Nabakishor Nongmaithem, Rambabu Dasi, Paluru Pavani	306
561	Automation in Floriculture: The future of flower production Meikam Ichancha	306
562	System of Rice Intensification: Method to Sustainable Rice Production Yumnam Sanatombi Devi	307
563	<i>In vitro</i> Evaluation of Biocontrol Agents (Native <i>Trichoderma</i> spp.) against <i>Fusarium</i> wilt of pea W. Tampakleima Chanu ^{1*} , Bireswar Sinha ² , Kota Chakrapani ² , Bijeeta Thangjam ² and K. Sarda ²	307
564	Relevance of contract farming in agricultural development Gargi Paliwal, Amardeep	308
565	Bionomics of South Indian <i>Callosobruchus chinensis</i> (L.) on Different Indian Pulses Devina Seram ¹ , James Watt Haobijam ^{1*} , Senthil Natesan ² and John Samuel Kennedy ³	308
566	People should avoid consuming animal products to reduce risk for chronic disease. YES/NO Seema ^{1*} and Vatsala Saharan ²	309
567	Current Status of Common Rust of Maize in India Soumen pati*, Ph. Sobita Devi, Nabakishor Nongmaithem, Prajna samal, Kota Chakrapani	309
568	Front line demonstrations on pigeon pea to enhance the production and minimize the yield gap Mamta Singh ¹ , A K Singh ² and KS Yadav ¹	310
569	Isolation of volatile oil constituents and their antibacterial activity of <i>Skimmia lauriola</i> from tehri garhwal Naveen Kumar	310
570	Yield enhancement of biosurfactant produced by <i>Meyerozyma guilliermondii</i> YK32 Dolly Rani* and Seema Sangwan	311
571	Rhizodegradation – A promising Organic Phytoremediation technology Akrati Dev and D.K. Dwivedi	311
572	Statistical analysis of farm Income Diversification among the valley and hill farmers of Manipur Kh. Rishikanta Singh ¹ , N. Uttam Singh ² and T. Basanta Singh ¹	311
573	Antifungal activity of some plant extracts against <i>Colletotrichum falcatum</i> causing red rot in sugarcane Anwar Ahmad ¹ , Jayant Mandal ¹ , Ajay Kumar ¹ and Sujeet Pratap Singh ²	312
574	Isolation, Identification and Use of Fungus for Plant Growth Ayushi Negi, Arjit Raj, Poonam Rani and Rohit Gautam	312

575	<i>In vitro</i> evaluation of antagonistic effect of <i>Trichoderma</i> spp. against <i>Fusarium oxysporum</i> f.sp. <i>lycopersici</i> causing <i>Fusarium</i> wilt of Tomato. Y. Premica Devi*, Ph. Sobita Devi, Bireswar Sinha, LNK Singh, Bijeeta Thangjam, Kota Chakrapani	313
576	CRISPR Technology For Crop Improvement- A Review Sindoor Nalajala*, M. Samuel Jeberson, E. Vani Divakara Sastry, M. Usha, Pravijith P	313
577	Phytoremediation—a way towards sustainability Jyoti Sharma*, Monika Menia, Monika Bonotra, Meenakshi Attri, Deepak Kumar	314
578	Tilling, A Reverse Genetic Approach For Crop Improvement-A Review M. Usha*, Pramesh Khoyumthem, Sindoor Nalajala, Pravijith. P	314
579	Dye yielding plants of goa-a qualitative study Suvarnagouri Yadappanavar ¹ , Varsha S. Naik ² , K.S. Das ³	314
580	Role of e-commerce in agriculture Swati Mehta, Ashiana Javeed, Ranjeet Singh Bochalya and Meenakshi Attri	315
581	Integrated Nutrient, Weed & Pest Management in Agriculture Ashiana Javeed and Swati Mehta	315
582	Innovative intercropping of chilli + muskmelon on plastic mulching during summer for doubling the farmers’ income Y. D. Pawar, S. H. Malve, D. A. Sadrasaniya and V. V. Prajapati	316
583	Precision farming –a resource conservation technology Kanik Kumar Bansal*, Jyoti Sharma and Monika Menia	316
584	Assessment of Variability, Heritability and Genetic Advance in Parthenocarpic Cucumber Gurpiar Singh* and Navjot Singh Dhillon	317
585	Study on Heterotrophic and Chemo-autotrophic Bacteria (nitrifying) in the Simulated Aquaculture System Anjulata Suman Patre* and S. B. Gupta	317
586	Agroforestry system adopted by farmers in hoshangabad district of madhya pradesh Nanita Berry, ITK Dilraj, Sourabh Dubey and Nikita Rai	318
587	Influence of different weed management practices on weed dynamics, yield attributes, yield and economics of black gram crop Sooraj Chandra Pankaj*, R. R. Upasani, and Sheela Barla	318
588	Potential of magnetite chitosan beads for removal of pesticides from water Anirban Sil, Neethu Narayanan and Suman Gupta	318
589	Identification of co-expressed genes in different fungal species used as biopesticide Niketa Chauhan ¹ , Prekshi Garg ¹ , Shalini Singh Visen ² , Prachi Srivastava ^{1*}	319
590	Dehydration of Flowers: A new value addition for floriculture Sanjana N Joshi and Veena S Jadhav	319
591	Biofortification a tool for enriching micronutrients in rice Vijay Kumar S ^{1*} , S. Pazhanisamy ² and Rodda Chandana Devi ³	320
592	<i>In vitro</i> evaluation and biochemical analysis of some plant extracts against green mould disease in Oyster mushroom (<i>Pleurotus sajra-caju</i>) Mallikarjun Channappa Chitti*, D.K. Sarmah and Sukanya Gogoi	320
593	Assessment of intraspecific crossability of cultivated Cowpea (<i>Vigna unguiculata</i>) varieties Bipramani Nameirakpam	320
594	Understanding the effects of environment on the development of climate resilient crops Bijeeta Thangjam*, Ph. Sobita Devi, LNK Singh, Bireswar Sinha, Kota Chakrapani, W. Tampakleima Chanu, Yengkhom Premica Devi and Tusi Chakma	321

595	New records of insect species damaging Moru Oak (<i>Quercus floribunda</i>) and their management Neha Sharma, Pawan Kumar, Subhash Chander and Bhumika Kanwar	321
596	Honeybee Enemies: A limiting factor in Beekeeping Yashica Mehtani and Sunidhi Pilonia	322
597	Phytoplasma on sesame: Distribution, symptomatology, diagnosis, etiology, host range, epidemiology, insect vectors, molecular characterization, transmission, and integrated management T. Boopathi, M. Sujatha, M. Santha Lakshmi Prasad, P. Duraimurugan and K. Sakthivel	322
598	Effect of bio-enriched farm yard manure (FYM) on growth, yield and economics of finger millet (<i>Eleusine coracana</i> (L.) Gaertn) under dryland condition Shafnas, I ¹ , Vasanthi, B. G ² , Altaf Kuntoji ³ and Thimmegowda, M. N. ⁴	323
599	Genetic characterization and Population structure study of elite genotypes for upland cotton (<i>Gossypium hirsutum</i>) using microsatellite based markers Pawan Kumar ^{1*} , Somveer Nimbali ¹ , R. S. Sangwan ¹ , Neeraj Budhlakoti ² and Sagar ¹	323
600	Nutraceuticals' potential role in COVID-19 Pratibha Arya and Neelesh Kumar Maurya	324
601	Superoxide Dismutase as a biochemical maker for zinc stress in higher plants: A review Kiran Bharti ^{1*} , Naveen Kumar ² , Neha Pandey ³ , Narendra Kumar ⁴ , Neelam Dhiwan ⁵	324
602	Efficiency of different Manures on the growth and yield of Rice (<i>Oryza sativa</i>) under open condition R Vijaykumar ^{1*} , Biswarup Mehera ² , Neelam Khare ¹ , M.Sekhar ³	324
603	Effect of organic substance, acid scarification and plant growth regulators on growth of tamarind (<i>Tamarindus indica</i> L.) seedling Khushboo Tandon*, P.K.S. Gurjar, R. Lekhi and Deepa Soni	325
604	Effect of supplementation of Neem (<i>Azadirachta indica</i>) leaf and Ginger (<i>Zingiber officinale</i>) powders on performance of Giriraja poultry birds S. R. Shegokar, S. D. Chavan, S. P. Nage	325
605	Effect of lactic acid fermentation on nutritional, anti-nutritional and bioactive components of finger millet (<i>Eleusine coracana</i> L.) Sumaira Jan ^{1*} , Krishan Kumar ¹ , Priyanka Thakur ¹ , Divya Chauhan ¹ , Qurat-Ul eain Hyder Rizvi ¹ , Naseer Ahmed ¹ and Ajar Nath Yadav ²	326
606	Seasonal study of stress in the Hill stream fish Golden Mahseer sampled from the Eastern Ramganga a tributary of Mahakali River Arun Kalkhundiya, Jyoti Chand, Bipin Chandra Pathak	327
607	Nutritional and Cooking Characteristics of Selected Pigmented Rice Landraces of Kumaun Himalayas Ajay Kumar*, Netrapal Sharma and Satpal Singh Bisht	327
608	Distributions and infestation analysis of poplar leaf defoliator <i>Clostera</i> sp. (Lepidoptera: Notodontidae) in North western India Jitendra Kumar and Arvind Kumar	327
609	To demonstrate the effective concentration of <i>Isaria fumosorosea</i> against Rugose spiraling whitefly in infected Betel Vine Leaves Kanuri Komala Siva Katyayani ¹ , Nelli Yashwanth Kumar ²	328
610	Recent Advances in Nutrient Management in Precision Agriculture in India Priya, P. ^{1*} and Ashoka, P. ²	328
611	Applications of Internet of Things (IoT) in Agriculture Priya, P. ^{1*} and Ashoka, P. ²	329
612	Role of market access for food and nutrition security in India Subodh Agarwal	329

613	Purification of ligninolytic enzymes from <i>Pleurotus</i> spp. and their evaluation in dye decolorization Asha Singh Rajavat ^{1,2} , Neeraj Shrivastava ² , V. Mageshwaran ¹ , Ritu Vishwakarma ¹ , Abha Agnihotri ² , Anil K. Saxena ¹ , K Pandiyan ^{3*}	330
614	Agricultural waste biomass utilization for energy production through gasification Sunil L Narnaware* and N L Panwar	330
615	Evaluation of Brinjal Genotypes for yield and its contributing traits S. Ganapathy and K. Nageswari	331
616	Evaluation of Sugarcane Clones for Yield and Quality Traits S. Ganapathy* and R.S. Purushothaman	331
617	Effect of storage containers and treatments for longevity of fenugreek Dileepkumar Masuthi, Jadhav Sulochana, Tatagar M.H., Sumangala Koulagi, Mahantesha B. N. Naika and Satish D	331
618	Improving quality of fenugreek varieties for incidence of powdery mildew disease Dileepkumar Masuthi*, Jadhav Sulochana, Tatagar M.H., Sumangala Koulagi, Mahantesha B. N. Naika and Satish D	332
619	Agriculture farm bills Shurti Gaba	332
620	Global agriculture Varun Kamboj	333
621	Ethnobotanical survey of medicinal plant species used by remote communities in District Chamoli, Uttarakhand Chandramohan Singh*, Naresh Tariyal, Shubham Thapliyal, Anushri Kukreti	333
622	Copper nanoparticles as an ameliorating agent for Paraquat toxicity in <i>Michrochaete</i> Sp. NCCU-342 Durdana Yasin & Tasneem Fatma*	334
623	Kalpa 1” A New late colour development apple bud sport originated from cv. Starking Delicious Heerendra Prasad*, Rinkey Arya, Johnson Lakra, Sunny Sharma, Sunil Kumar and Jayesh Garg	334
624	Organic Farming for Sustainable Agriculture in India Anju Bijarnia	334
625	Soil and Water Conservation in Agriculture Monika choudhary	335
626	Integrated Weed Management in Herbaceous Field Crops Roshan Kumawat	335
627	BIOFERTILIZER MADE BY POULTRY FEATHER WASTE Arpana Pal ¹ , Dr. Keerti Singh ² , Dr. Kunal Kishor ³	336
628	PRINCIPLES AND METHODS OF PEST CONTROL & THEIR SUPPORTING FACTOR OF POPULATION Vinay Pandey and Khushboo Dubey	336
629	Management of Antifungal Treatment Through Herbal Preparations Payal Sehgal ¹ , Dr. Keerti Singh ²	337
630	Effect of Ropinirole silver nanocomposite on the transgenic <i>Drosophila</i> model of Parkinson’s disease Falaq Naz ^a , Rahul ^a , Mahino Fatima ^b , Swaleha Naseem ^c , Wasi Khan ^d , Amal C. Mondal ^b , Yasir Hasan Siddique ^a ,	337
631	Effect of kaempferol on the cognitive deficits and oxidative stress induced by the expression of alpha synuclein in the transgenic <i>Drosophila</i> model of Parkinson’s disease Rahul*, FalaqNaz, Yasir Hasan Siddique	337

	AN ECONOMIC ANALYSIS ON PALMAROSA (<i>Cymbopogon martini</i>)	
632	CULTIVATION IN THIRUVANNAMALI DISTRICT OF TAMIL NADU Radhakrishnan.S ¹ , Srinivasan.G., and Balu.D ²	338
633	Begomovirus: a future challenge for economically important crops Mohammad Ansar	338
634	Reproductive biology and pollination ecology of <i>Berberis lycium</i> Royle: A highly valued shrub of immense medicinal significance Susheel Verma* ^{#1} and Ishfaq Ahmad Wani ^{#1}	339
635	Soil nematode diversity in rice fields during different seasons Rawhat Un Nisa ^{1*} and Ali Asghar Shah ¹	339
636	Mononchid nematodes' role in agriculture as biocontrol agents against plant-parasitic nematodes Shaheen Majeed Wani ^{1*} , A. A. Shah ²	339
637	DNA barcoding aids in identification of adulterants of <i>Trillium govanianum</i> Wall. ex D. Don Shahid Ul Islam ^a and Tanvir Ul Hassan Dar ^{a*}	340
638	Natural farming Surbhi Prithiani, Harshita Mali	340
639	Management of Antifungal Treatment Through Herbal Preparations Payal Sehgal and Dr. Keerti Singh	341
640	Propagation of Rose by Cutting Method Aditya Mittal, Moinuddin and Ankit Semwal	341
641	Role of Biochar in Soil Nutrient Management Priyanka Juyal and Moinuddin,	342
642	Influence of Nutrient Management Practices on growth and yield of Mustard (<i>Brassica juncea</i> L.) Vaishnavi Sharma and Moinuddin	342
643	Bioefficacy of <i>Trichoderma</i> Species in Controlling Fruit Rot Disease of Chilli in Kashmir Valley Anees Un Nisa ¹ , Shayiestah Maqbool and Dr. Mohd. Yaqub Bhat*	342
644	Elucidating cold induced oxidative stress effects on morphology and reproductive aspects of Pusa Sheetal cultivar of Tomato (<i>Solanum lycopersicum</i>) plants. Nadia Gul ^{1*} and Saima Aslam ¹	343
645	Diversity of Plant Parasitic Nematodes associated with rhizosphere of Banana from different areas of District Rajouri, Jammu and Kashmir, India Kaisar Ahmad Allie* Shaheen Majeed Wani and A. A. Shah	343
646	Epiphytic lichen Diversity in the Pir-Panjal Region of Jammu and Kashmir, India: threats and conservation Musarrat Fatima* and Mamta Bhat	344
647	Potential underutilized fruit crops of Eastern region of India Kumari Karuna ¹ and Abhay Mankar ^{2*}	344
648	Agroforestry: A Suitable option to increase farmer's income in Jabalpur region of Madhya Pradesh Parul Sharga ¹ , Dr.S.D Upadhyaya ² , Dr.Nanita Berry ³ , Dr.D.V.Bhagat ⁴ .	344
649	Impact of Organic Nutrient Management on Yield and Economics of Green Gram (<i>Vigna radiata</i> L.) Rahul ^{1*} , Shikha Singh ¹ , M. R. Meshram ¹ and Shivani Kumari ²	345
650	Impact of Nutrient Management on Yield and Economics of Pearl Millet (<i>Pennisetum Glaucum</i> L.) Niteen Amarghade* and Rajesh Singh	345
651	Development of Climate Resilient Rice Varieties	346

	Y.Suneetha	
	Purification of ligninolytic enzymes from <i>Pleurotus</i> spp. and their evaluation in dye decolorization	
652	<u>Asha Singh Rajavat</u> ^{1,2} , Neeraj Shrivastava ² , V. Mageshwaran ¹ , Ritu Vishwakarma ¹ , Abha Agnihotri ² , Anil K. Saxena ¹ , K Pandiyan ^{1,3*}	347
653	Preparation of high porous-carbon from Agricultural waste	347
	Mattaparathi Lakshmi Durga, Sandip Gangil and Vinod Kumar Bhargav	
654	Comparison of Residual Effect of Different Sources of Zinc in terms of Apparent Recovery Efficiency in Rice-Maize Cropping System	348
	Aswathy. S. Nair *G. Padmaja	
655	Biochemical profiling of safflower (<i>Carthamus tinctorius</i>) petals	348
	Praduman Yadav ¹ , Shiva Shanker Kaki ² and Mukta N ¹	
656	Comparative study on soaking and germination on the nutritive, anti-oxidant activity, and bioactive composition of Quinoa	349
	Priyanka Thakur*, Krishan Kumar, Divya Chauhan, Qurat Ul Eain Hyder Rizvi, Sumaira Jan, Naseer Ahmed, and Tajendra Pal Singh	
657	The Santhal painting- Magic in hues'' Vulnerable Art that needs attention	349
	Shalini Pandey*	
658	Effect of organic nutrient management on productivity, sustainability and economics of bushy type rajmash (<i>Phaseolus vulgaris L</i>) under sub alpine conditions of Bhadarwah	350
	<u>Rohit Sharma</u> , Neeraj Kotwal, Manoj Kumar, Mahital Jamwal, Sanjeev Kumar, N. P. Thakur, Manpreet Kour Parshotam Kumar and Vishal Sharma	
659	Approaches for oil quality enhancement in Rapeseed (<i>Brassica campestris L.</i>)	351
	VIVEK SINGH*, SHARAD PANDEY**, GIDEON SYNREM***	
660	Physio-chemical analysis of quality, evaluation and development of Bottle gourd lemon mint squash	351
	^{1*} Ashish Kumar, ¹ Aplana	
661	NEW RECORD OF SPIRALLING WHITEFLY, <i>ALEURODICUS DISPERSUS</i> , RUSSEL (HOMOPTERA: ALEYRODIDAE) IN BRINJAL FROM MANIPUR	352
	SUSHMITA THOKCHOM	
662	Post-harvest management for improving shelf life of banana fruit	352
	Abhay Mankar ¹ , K. Karuna ^{2*} and Ruby Rani ²	
663	Analysis of soil samples for different physico-chemical properties in middle IGP of Bihar	352
	Basant Kumar Sharma ¹ and M. Shamsul Islam ²	
664	Forest Fire Management: A review	353
	Ranjeet Kumar, Richa Sharma, Krishna Kumari and Sangeeta Verma	
665	Effect of Cutting Length and Cutting Diameter on Macropropagation of <i>Melia composita</i>	353
	¹ Sakeena Gul Niazi*, ² Dinesh Kumar and Ashok Kumar	
666	HEAT INDUCED DECREASED ACTIVITY OF NITRATE REDUCTASE AND ITS IMPACT ON YIELD UNDER LATE SOWN CONDITION IN THREE GENOTYPE OF WHEAT (<i>TRITICUM AESTIVUM L.</i>)	354
	Kamla Jakhmola*, Sobha, Shweta Sahni	
667	Chromatographic and spectroscopic analysis of heartwood extract of <i>Pterocarpus</i> species	354
	Kamal Mishra ¹ , S. S. Bisht ¹ , K. K. Pandey ¹ , Girish Chandra ²	
668	EFFECT OF DIFFERENT CONCENTRATIONS OF KINETIN ON <i>IN VITRO</i> SHOOT MULTIPLICATION OF BAMBOO	355
	Chavan N. S., Chavan N. R., and Kale Sonam S.	

669	ASSOCIATION MAPPING FOR DIFFERENT PHENOTYPIC TRAITS USING ELITE SORGHUM [<i>Sorghum bicolor</i> (L.)] GERMPLASM LINES Chavan N. R., Kale Sonam S., Chavan N. S. and Sonwane V. R.	355
670	ISOLATION, CHARACTERIZATION AND GENETIC DIVERSITY ANALYSIS OF <i>TRICHODERMA</i> ISOLATES ISOLATED FROM GANDHELLI, AURANGABAD REGION Kale Sonam S., Chavan N. S., Chavan N. R., and Tapse S.	356
671	Development of synbiotic lassi by using buffalo milk S. G. Jagadale, Y. N. Patil, S. S. Ramod, V. B. Kadav and V. S. Dandekar	357
672	Preparation of milk shake by using jaggery and Date (<i>Phoenix dactylifera</i> L.) S. V. Surve, N. T. Chorage, Y. N. Patil, A. J. Mayekar and V. S. Dandekar	357
673	Detection and Isolation of Seed Mycoflora of Lablab bean, Horse gram and Cowpea Y K Nirgude, R R Rathod, U R Phondekar, R R Kalaskar and U V Mahadkar	357
674	GIS Based Decision Support Systems in Agriculture Mahipal Singh Choudhary	358
675	Molecular Genetic Analysis for YMV Resistance in Blackgram(<i>Vigna mungo</i> L. Hepper) K. R. SARAVANAN*, P. KARTHIKEYAN, S. VENNILA ³ , and S. SUGANTHI ⁴	358
676	COMPATIBILITY OF ESSENTIAL OILS WITH ENTOMOPATHOGENIC FUNGI; A POTENTIAL TOOL FOR INSECT-PEST MANAGEMENT Renu Pandey* ¹ and Sapna Tiwari ²	359
677	Breeding for disease resistance in Bamabara groundnut Chitti Bharatkumar, Nandini R, Shweta A Mannikeri, Kailash Chandra, Umesh Naik and Pranesh	359
678	Effect of Foliar Application of Borex Levels on Growth, Yield and Quality of pomegranate (<i>Punica Granatum</i> L.) Om Prakash Jitarwa ¹ , Satpal Baloda ² , Keshar Mal Choudhary ³ and sushil ⁴	360
679	Impact of different sources of fertilizers on yield and quality parameters of Kinnow mandarin Monika Yadav, G.S. Rana, R.P.S Dalal, Vijay, Sonu Kumari	360
680	Breeding technology changes the landscape of ruminant industry R.I.A. Raja Khalif	361
681	Molecular Genetic Analysis for YMV Resistance in Blackgram(<i>Vigna mungo</i> L. Hepper) K. R. SARAVANAN*, P. KARTHIKEYAN, S. VENNILA ³ , and S. SUGANTHI ⁴	361
682	Response of Manures and Inorganic Sources of Nutrient on Growth, Yield and Quality of Chickpea (<i>Cicer arietinum</i> L.) V.K Singh, Ankur Sharma and Shreya Bhatt	362
683	STATUS OF ENDANGERED AND EXTINCT MEDICINAL PLANTS OF UTTARAKHAND HIMALAYA: A REVIEW Subhdara, Kamla Dhyani and Sobha	362
684	Impact of Vermicompost based Integrated Nutrient Management on Productivity Enhancement of Broccoli and Soil Properties under Hill Agro-ecosystem of North East India Popiha Bordoloi	363
685	Evaluation of Potential Biocontrol Bacterial Strains against <i>Verticillium</i> Wilt of Cotton Kamaldeep Kaur, Ashish Vyas	363
686	Agronomic performance of Lentil under the various weed management strategies Priyanka Bankoti, Mansi Nautiyal*	364

687	PLANT GROWTH PROMOTING RHIZOBACTERIA (PGPR), ITS IMPORTANCE AND FUTURE PERSPECTIVES IN AGRICULTURE	364
	Shalini Kotiyal ¹ and Manjusha Tyagi*	
688	Performance of wheat (<i>Triticum aestivum</i>) varieties under cold stress condition	365
	Girish Chandra* ¹ , Radha Upadhyay ² , Kamla Dhyan ³ and Sobha Bisht ¹	
689	Ways to encourage participation of farmwomen in family welfare and agricultural development	366
	Nidhi B. Thakur ¹ and J. B. Patel ²	
690	Seed Vigour Tests on Different Cultivars Of <i>Phaseolus Vulgaris</i> Grown In Chamoli District Of Uttarakhand, India	366
	*Sobha and J.S. Chauhan and Kamla Dhayani	
691	Open heap compost system: A promising traditional practice for sustainability of Hill-agro-ecosystem in Indian Himalaya's	367
	*Akshat Uniyal ¹ , Krishna K Singh ² and N S Bisht ³	
692	Applications of biodegradable polymers in food packaging industry	367
	Mohammad Amir ^{1#} , Roohi ¹ , Mohammed Kuddus ^{2*}	
693	Impact of planting methods and weed control practices on growth, yield and quality of paddy	368
	Avinash Kumar Singh, RS Yadav, Deepak Kumar, Gyanendra Kumar and Sunil Kumar	
694	Morphological assessment of Asian elephant (<i>Elephas maximus</i>) ivory retrieved from Dharamjaigarh Forest Division of Chhattisgarh, India.	368
	Aman Kumar ¹ , S.S. Dhuria ¹ , Pranay Mishra ²	
695	Antimicrobial Treatment on Cellulosic Fibre using Agro Waste (Lemon Peel)	368
	Sushila* ^a , Nisha Arya ^a , Sarita Devi ^b , Kamla Malik ^c , Vivek Singh ^a	
696	OPTIMIZING SUITABLE SUMMER PULSES AND SOWING TIME FOR RICE FALLOW SEQUENCES.	369
	Mayanglambam Bishonath Singh	
697	Comparison of Open Source DEM's for Morphometric Analysis of micro watersheds: a case study from the midlands of Kerala	369
	Md. Majeed Pasha and Sathian K.K.K.	
698	Characterisation and Prioritization of Micro watersheds Using Geospatial Techniques: A Case Study on river Bharathapuzha, Kerala	369
	Md. Majeed Pasha and Sathian K.K.K.	
699	Seasonal abundance of large white cabbage butterfly from mid hills of Garhwal, Uttarakhand	370
	Anshuman Semwal	
700	PRODUCTIVITY OF MALBAR NEEM (<i>Melia dubia</i>) BASED AGROFORESTRY SYSTEM IN NORTHERN TRANSITIONAL ZONE OF KARNATAKA	370
	Chavan, R. L., Pawar, K. N., Hundekar, S. T., Vasudev L. and Mokashi, M. V.	
701	PROVENANCES VARIABILITY IN GROWTH AND PRODUCTIVITY OF NEEM (<i>Azadirachta indica</i> (A. Juss.) IN NORTHERN TRANSITIONAL ZONE OF KARNATAKA	371
	Chavan R. L., Pawar K. N., Nayak B.G., Hundekar S. T. and Mokashi, M. V.	
702	STUDIES ON GENETIC VARIABILITY FOR YIELD AND YIELD CONTRIBUTING TRAITS IN COWPEA (<i>Vigna unguiculata</i> (L.) Walp)	371
	*P. D. Waghmare ¹ , U. B. Pethe ² , B.S. Thorat ³ and V.V. Dalvi ⁴	
703	Epidemiology of sesamum phyllody	371
	Sunita J. Magar, Kamble S.M. and Somwanshi S.D	
704	Management of sesamum phyllody by adjusting date of sowing	372
	Sunita J. Magar, Kamble S.M. and Somwanshi S.D.	

705	Evaluation of mungbean varieties against mungbean yellow mosaic virus Sunita J. Magar, Sarode SG and S.D.Somwanshi	372
706	Effect of date of sowing on whitefly and mungbean yellow mosaic virus Sunita J. Magar, Sarode SG and S.D.Somwanshi	373
707	Seasonal incidence of Chilli Aphids on Chilli N.E.Jayewar ^{1*} and B. B. Bhosale ²	373
708	Seasonal incidence of Chilli mites in Marathawada N.E.Jayewar ^{1*} and B. B. Bhosale ²	373
709	Socio-Economic profile and constraints perceived by the vegetable growers of Manipur James W Haobijam ¹ , Devina Seram ^{2*} , Guneshori Maisnam ¹ , Y L Devi ¹ and Termeric Oinam ¹	374
710	EFFECT OF INTEGRATED NUTRIENT MANAGEMENT ON GROWTH, YIELD AND ECONOMICS OF SWEETCORN ALONG WITH POST HARVEST NUTRIENT STATUS OF SOIL Anjali Patel	374
711	Evaluation of food grains for preparation of spawn for cultivation of <i>Calocybe indica</i> Dibakar Panda ^{1*} and Mohan Kumar Biswas ²	375
712	Awareness and impact of Soil Health Card with reference to crop production in India Abhinav Singh ¹ , Amritanshu Singh ¹ , Virendra Pratap ¹ and Tarkeshwar ²	375
713	Study on use of Mobile phone technology by the Farmers in Balrampur District of Uttar Pradesh Virendra Pratap ^{1*} , A.K. Singh ² , Abhinav Singh ¹ and Amritanshu Singh ¹	375
714	Effect of garlic powder, Moringa oleifera leaf powder or their combination on growth performance, carcass attributes and blood biochemical parameters of broiler chickens. Ittehad, Nazim Ali, Ahmad Fahim, D.S. Sahu, M.K. Bharti, Rajbir Singh, Debashis Roy and R.A. Siddiqui	376
715	Estimation of Genotype X Environment interaction for Yield and Yield Contributing Characters in Sesame (<i>Sesamum indicum</i> L.) Bhagwat Singh*, Rajani Bisen and Y.K. Shukla	376
716	Diagnostic features and distribution status of <i>Viola</i> species along with concurring plant taxa from Jammu Himalaya Geeta Sharma,* Tasir Iqbal	376
717	Afforestation and Development of Wasteland through Agroforestry Kushmita Dhan,Firoz Ahmad, B.C Oraon	377
718	Biodiversity of Predatory Coccinellid Beetles (Coccinellidae: Coleoptera) from agricultural ecosystem of Garhwal region of Uttarakhand, India Pushpendra K. Sharma	377
719	Managing diseases of Mango Archana Kushwaha ¹ , Jitendra Chandra Chandola ² and Vijay Kumar ²	377
720	Comparative efficiency of nano-mineral on growth performance, blood biochemical and carcass characteristics in commercial broiler production Najeebullah Azizi, Nazim Ali, Debashis Roy, Ahmad Fahim, D.S. Sahu, Rajbir Singh and R.A. Siddiqui	378
721	A Study on different flower extracts sprays in attraction of natural enemies in cabbage crop ecosystem M. Sreedhar ^{*1} , Sunil Dutt Pant ¹ , Dr. R. P. Maurya ¹ and A. Vasudha ²	378

722	Evaluation of botanicals and bioagents for the management of early blight disease of tomato <u>Pooja Sangwan*</u> , Rakesh Sangwan, Vinod Kumar Malik, Manjeet Singh and M.S. Bochalya	379
723	Evaluation of fungicides for the management of early blight disease of tomato <u>Pooja Sangwan*</u> , Vinod Kumar Malik, Rakesh Sangwan, Manjeet Singh and M.S. Bochalya	379
724	Conservation and commercialization of hill stream fish, Garra gotyla gotyla (Gray 1830) through Induced breeding Preeti Bhatt ^{1*} , R.S. Patiyal ¹ , B.C. Pathak ²	379
725	Climate Change modeling and projections for Agriculture in Chhattisgarh Alok Kumar Chandrakar	380
726	Sheath blight (Rhizoctonia solani) a serious threat for rice cultivation Mahaveer Singh Bochalya ^{*1} , Vipul, Manjeet Singh, Vinod kumar Malik and Pooja sangwan	380
727	Leaf Blast of rice, a hurdle in export of basmati rice Mahaveer Singh Bochalya ^{*1} , Vipul, Manjeet Singh, Vinod kumar Malik and Pooja sangwan	381
728	Defense signaling mechanism in plants against micro-creatures Mahaveer Singh Bochalya ^{*1} , Vinod kumar Malik, Pooja sangwan and Manjeet Singh	381
729	Prospects of remote sensing in assessing soil health Ritambhara	382
730	Citronella plants can be a valuable choice for biological management of invasive Eupatorium adenophorum Sonam Rawat*, Monali Chauhan, Pallavi sati, Sudeep Chandra, M.C. Nautiyal	383
731	A study on Effectiveness of ICT Module on Dissemination of Knowledge among Dairy Farm women Geeta Channal and ** Rekha Rayanagoudar	383
732	Prevalance Of Bacterial Contamination and Antibiotic Susceptibility in River Ganga At Rishikesh And Hardwar . Sangeeta Madan and Deepika Sharma	383
733	Organic pollutants in waste water and its remediation approaches using graphene adsorbent Krishna Rawat	384
734	Forest Fire and its influence on environmental conditions: A review Rajesh Kumar ¹ , Harischandra Darro ² , Atul Kumar Bhardwaj ³ , K. K. Chandra ⁴	384
735	Antagonistic performance of Trichoderma spp. against Colletotrichum falcatum causing red rot in sugarcane * Jayant Mandal/ Anwar Ahmad / Dr. Sujeet Pratap singh/ Dr. Ajay kumar.	384
736	Recycling of Organic Wastes: A Promising Alternative to Augment Soil Fertility Ritika Gupta ^{1*} , Dr. Narinder Panotra ² , Jyoti Sharma ³	385
737	Promising Cultural Weed Management Practices to limit crop-weed competition in Peas (Pisum sativum L.) in the North-western Himalayan Region Gaytri Hetta, SS Rana, Sarwan Kumar and Belal Ahmad Mujahed	385
738	Development of Targeted Yield Equations on German Chamomile (Matricaris retutica) in Young Alluvium Calcareous Soils S. N. Suman, Shankar Jha, Sanjay Kumar Singh, Vipin Kumar and J. Prasad	386
739	Soil organic carbon fractions and carbon stocks in different orchards of eastern Indo-gangetic plains of India Vipin Kumar*, S.N. Suman and Kaushal Kishor	386
740	ROLE OF METABOLOMICS IN TOLERANCE TO DROUGHT STRESS Dr. V. V. Padmaja, Dr. M. Jayaprada and Dr. B. Srinivasulu	386

741	Conservation of natural resources and their management through tribal women participation in protected areas of central India Poonam Xess and Garima Tiwari	387
742	Genetic studies in F ₂ population of Tomato (<i>Solanum lycopersicum</i> L.) for yield and quality traits Mamatha, N. C. *, Lingaiah, H. B. and Jyoti, H. K.	387
743	Genetic characterization and Population structure study of elite genotypes for upland cotton (<i>Gossypium hirsutum</i>) using microsatellite based markers Pawan Kumar ^{1*} , Somveer Nimbale ¹ , R. S. Sangwan ¹ , Neeraj Budhlakoti ² and Sagar ¹	387
744	EFFECT OF NANO-SULPHUR FERTILIZER ON SUNFLOWER CROP R. Rajeswari* and K.S. Subramanian	388
745	Innovative Extension Systems for Climate Resilient Agriculture Sujaivelu. T., Kalirajan, V., Balamurugan, V and D.Balu	388
746	NEED FOR DEVELOPMENT OF TRIBAL KNOWLEDGE NETWORK FOR SUSTAINABILITY Vengatesan, D ., Balu, D., Rangunath.S and E.Suriyapriya	388
747	TRIBALS FLAVOR THE SPICE INDUSTRY Rangunath, S and S.K.Kammar	389
748	A STUDY ON COST AND RETURNS OF JAGGERY PRODUCTION IN TAMILNADU K.Marikannan ¹ , A.Mehazabeen ² and G.Srinivasan ³	389
749	A CONSTRAINT ANALYSIS ON PRODUCTION AND MARKETING OF MAIZE IN TAMILNADU G.Srinivasan ¹ ,K.Marikannan ² and A.Mehazabeen ³	389
750	A CONSTRAINT ANALYSIS ON PRODUCTION OF JAGGERY IN TAMILNADU A.Mehazabeen ¹ ,K.Marikannan ² and G.Srinivasan ³	390
751	Innovative Extension Systems for Climate Resilient Agriculture Sujaivelu. T., Kalirajan, V., Balamurugan, V and D.Balu	390
752	Efficacy of different insecticides against tea mosquito bug, <i>Helopeltis antonii</i> Signoret (Hemiptera: Miridae) in cashew in costal Karnataka Raviraja Shetty, G., Lakshmana and Abhishek M. S.	391
753	Evaluation of some bioagents, botanicals and biorational insecticides against mealybug, <i>Phenacoccus solenopsis</i> (Hemiptera: Pseudococcidae) in tomato under field conditions M. S. ABHISHEK ^{1*} , B. C. HANUMANTHASWAMY ¹ , T. VENKATESAN ² and K. SELVARAJ ²	391
754	Effect of different carrier agents on freeze dried button mushroom: a review *Rafeeya Shams, Jagmohan Singh	391
755	KNOWLEDGE OF ENVIRONMENTAL ISSUES AMONG COLLEGE STUDENTS OF DHARWAD, KARNATAKA, INDIA SHOBHA KASAR* and SAKEENA NAIKWADI**	392
756	<i>Haldina cordifolia</i> : A suitable in-vitro and in- Vivo regeneration technique for its domestication and its conservation practices. Astha Singh ¹ Dr. K.K Chandra ²	392
757	Effect of inulin supplementation as prebiotic on the performance of Barbari goats fed high or low-concentrate diet Abhishek Kumar, Ahmad Fahim*, D.K. Singh, Amit Kumar, Nazim Ali, Debashis Roy and G. Chandra	392
758	Foreign Direct Investment and the Indian Economy Keshav Kumar	393

759	The New Integrated Pest Management Paradigm for the Modern Age Anjali Nagori ¹ , Manish Bishnoi ² , Rakesh ³	393
760	Impact of Trace Minerals Supplement on Reproductive Performance of Crossbred Cattle Dheeraj Kumar ¹ , Rajendra Kumar ²	393
761	Prosopis Cineraria Based Agroforestry for Hot Arid Regions of Rajasthan Ankush Godara ¹ , Lokender Singh ²	394
762	Synthesis of cellulose nanofibrils and development of composites Garima Joshi	394
763	A Study on Preferences amongst Women and Trans women on Social Aspects of Clothing Neha Singh, Dr. Pintu Mishra, Dr. Rena Mehta, Dr. Divya Sharma	394
764	ROLE OF MINOR FOREST PRODUCES IN SUSTAINABLE DEVELOPMENT Damini Sharma	395
765	Effect of temperature and pH level on the growth of bacterial wilt causing Ralstonia solanacearum bacteria under in vitro conditions R. R. Bhanwar	395
766	Pattern of Livelihood Diversification of Households in India Diksha, Sudhakar Dwivedi, Jyoti Kachroo, Akshaydeep	395
767	Allelopathic effect of Cymbopogon nardus on Eupatorium adenophorum Sonam Rawat*, Monali Chauhan, Pallavi sati, Sudeep Chandra, M.C. Nautiyal	396
768	Correlation coefficient and Path analysis for seed yield and its attributing traits in Niger[Guizotia abyssinica (L. f.) Cass.] Dr. J.L. Salam and Kusumlata baghel,	396
769	Changes in Structural Characteristics of Humic acid in soils having different nutrient management practices as revealed by spectroscopic techniques Priya Saini ¹ , Abir Dey ² and Mahesh C. Meena ²	397
770	Tolerance of Eisenia fetida towards herbicide (metsulfuron-methyl) Anu Bala Chowdhary ^{1*} , Jahangeer Quadar ¹ , Sharanpreet Singh ¹ , Jaswinder Singh ² , Adarsh Pal Vig ^{1#}	397
771	Effect of germination on nutritional and anti-nutritional components of Adzuki bean Qurat Ul Eain Hyder Rizvi*, Krishan Kumar, Priyanka Thakur, Divya Chauhan, Naseer Ahmed.	398
772	Conservation of natural resources and their management through tribal women participation in protected areas of central India	398
773	RELEVANCE OF CONTRACT FARMING IN AGRICULTURAL DEVELOPMENT Gargi Paliwal ¹ ; Dr. Amardeep ²	398
774	Bionomics of South Indian Callosobruchus chinensis (L.) on Different Indian Pulses Devina Seram ¹ , James Watt Haobijam ^{1*} , Senthil Natesan ² and John Samuel Kennedy ³	399
775	People should avoid consuming animal products to reduce risk for chronic disease. YES/NO Seema ^{1*} and Vatsala Saharan ²	399
776	ISOLATION OF VOLATILE OILCONSTITUENTS AND THEIR ANTIBACTERIAL ACTIVITY OF SKIMMIA LAURIOLA FROM TEHRI GARHWAL Naveen Kumar	400
777	Yield enhancement of biosurfactant produced by Meyerozyma guilliermondii YK32	400

	Dolly Rani* & Seema Sangwan ²	
778	Rhizodegradation – A promising Organic Phytoremediation technology Akрати Dev and D.K. Dwivedi	400
779	Statistical analysis of farm Income Diversification among the valley and hill farmers of Manipur Kh. Rishikanta Singh*, N. Uttam Singh [#] and T. Basanta Singh*	401
780	Antifungal activity of some plant extracts against Colletotrichum falcatum causing red rot in sugarcane Anwar Ahmad ¹ , Jayant Mandal ¹ , Ajay Kumar ¹ and Sujeet Pratap Singh ²	401
781	Isolation, Identification and Use of Fungus for Plant Growth Ayushi Negi, Arjit Raj, Poonam Rani and Rohit Gautam	402
782	Effect of bio-enriched farm yard manure (FYM) on growth, yield and economics of finger millet (Eleusine coracana (L.) Gaertn) under dryland condition Shafnas, I., ¹ Vasanthi, B. G., ² Altaf Kuntoji ³ and Thimmegowda, M. N. ⁴	402
783	Mutation breeding: An approach for induced variability and genetic improvement in medicinal and aromatic plants Maneesha Singh	402
784	Adsorption study of acidic and basic dyes of identical molecular weight onto Activated Carbon. Alka Harit* and Akshay Gautam	403
785	Record on egg parasitoids of the family Trichogrammatidae (Hymenoptera: Chalcidoidea) from Chhattisgarh, India ¹ Mohsin Ikram *, ² Rajendra Prasad, ³ Mahipal Singh, ⁴ Salman Khan, ⁵ Manendra Kaneria, ⁶ Manish Kaneria	403
786	In-silico assessment of Biphenyl Dioxygenase activity from Pandoraea PnomenusaB-356 with different PCBs congeners Neha Singh 1, Vikram Dalal 2, Pravindra Kumar 3	404
787	Effect of cultivars, environment and their interactions on growth and yield of tomato (Solanum lycopersicum L.) MukeshKumar, Durvesh KumarSingh and DineshKumarSingh	404
788	WEED DYNAMICS AND ITS MANAGEMENT UNDER DIFFERENT FERTILITY LEVELS WHEAT (<i>Triticum aestivum</i>) IN DOON VALLEY CONDITIONS Sachin Kumar, Roop Kishore Sharma and Moinuddin*	405
789	Role of systemic and contact insecticides for the management of Sal seed and seedling borer Pammene theristis Meyrick (Lepidoptera: Tortricidae) Manisha Sharma 1, K.P. Singh 1 and Mohammad Faisal*	405
790	Innovative Approach in Agriculture and Allied Sciences Nano-chitosan, a biosmart molecule in sustainable agriculture. Harshita Mali*, Surbhi Prithyani and Pratibha	405
791	Mulching Practices: A Boon for Horticulture Sector Techi Goven Tara, Suneeta Singh, Anil Kumar Saxena and Moinuddin	406
792	Role of rural youth in decision making related farming system in Fatehpur district of Uttar Pradesh Alimul Islam* and Moinuddin**	407
793	Sericulture Industry in India–An overview Bamang Siku, Suneeta Singh, Anil Kumar Saxena and Moinuddin	407
794	Frontline Demonstration of Paddy Drum Seeder (8 Row) under Well Irrigated Rice in Nalgonda District, Telangana State, India T.Bharath* ¹ , M.A.Aariff Khan ¹ , M.Shankar ¹ , M.Shankaraiah ¹ , and S.Pallavi ¹	407
795	INSECTS BIO-DIVERSITY AND ITS CONSERVATION	408

3rd International Conference on “Global Initiative in Agricultural, Forestry and Applied Sciences for Food Security, Environmental Safety and Sustainable Development (GIAFAS-2021)”

	Mohammad Faisal, Sharad Pandey and Moinuddin*	
796	Response of Sweet william (<i>Dianthus barbatus</i>) to salicylic acid under moisture stress Rifat Ramzan, F. A. Khan, F. U. Khan, S. A. Bhat, S. A. Mir, Moinuddin, Sabah A. Dar and Manoj Kumar Prajapati+	408
797	Alleviation of low temperature induced damage by exogenous application of melatonin in French bean (<i>Phaseolus vulgaris</i> L.) Sabah A. Dar, F. A. Khan, S. Narayan, F. U. Khan, S. A. Bhat, S. A. Mir, Moinuddin, Rifat Ramzan and Manoj Kumar Prajapati+	409
798	Evaluation of tomato (<i>Lycopersicum esculentum</i> Mill.) genotypes for plant growth, fruit yield and quality Hilal A. Bhat, F. A. Khan, Zaffar M. Dar, S. Narayan, S. A. Mir, A. A. Malik, S. A. lone, Sehrish sajad, Urfia jan and Manoj Kumar Prajapati+	409
799	Quality and shelf life of kiwifruit (<i>Actinidia deliciosa</i> A chevalier) as influenced by certain post-harvest treatments Mohammad Younus Mir, Farooq Ahmad Khan, Moinuddin Manoj Kumar Prajapati+	410
800	Effect of seed soaking and priming methods on physiological potential of seed germination in okra (<i>Abelmoschus esculantas</i> L.) Fasil Fayaz, F. A. Khan, S. Narayan, S. M. zargar, S. A. Bhat, S. A. Mir and Moinuddin	410
801	STUDIES ON INSECT PESTS OF APPLE IN KASHMIR AND ITS INTEGRATED MANAGEMENT APPROACHES Shabir Davood Wani ¹ ,*Mohd Majid Jamali ¹ Moinuddin ² & Rayees Afzal Mir ¹	411
802	Effect of Nitrogen Sources and Row Spacing on Growth and Yield of Baby corn (<i>Zea mays</i> L.) Prabhat Kumar Chaturvedi	411
803	Biodiversity of Predatory Coccinellid Beetles (<i>Coccinellidae</i> : <i>Coleoptera</i>) from agricultural ecosystem of Garhwal region of Uttarakhand, India Pushpendra K. Sharma	411
804	Modern Concept of Zero Budget Natural Farming Udai Singh Rawat, Moinuddin and Garima Kaushik Parashar	412
805	An Eco-Friendly Textile Fiber from Lotus Jyoti Roy, Moinuddin* and Ankit Semwal*	412
806	Life cycle, incidence and intensity of attack of cut and dry bamboo borer- <i>Chlorophorus annularis</i> Fab. (<i>Coleoptera</i> : <i>Cerambycidae</i>) K.P. SINGH ¹ and Mohammad Faisal ²	413
807	Current Scenario of Precision Farming in India Moinuddin, Nidhi Srivastava, Kumari Anjali, Vineeta Pandey and Satendra Tiwari	413
808	Role of Genetics & Plant Breeding In Maintaining Positive Relationship Between Food Security, Environmental Safety & Sustainable Development. NISHTHA* ¹ , SHANZA BAIG ² & AKASH SHUKLA ³ .	413
809	Study of Diversity of Family Encyrtidae (<i>Hymenoptera</i> : <i>Chalcidoidea</i>) in Forest and Agricultural and horticulture Habitat of Doon Valley, Uttarakhand, India. Rashmi Nautiyal and Sudhir Singh*	414
810	Yield Gap Analysis Through Cluster Frontline Demonstrations in Groundnut in Nalgonda District, Telangana State Shankar, M1*, M. A. Aariff Khan ¹ , T. Bharat ¹ , S. Pallavi ¹ , M. Shankaraiah ¹ and K. Sumalini ²	414
811	ROLE OF PLANT BREEDING TECHNOLOGIES AND STRATEGIES TO MAINTAIN THE POSITIVE RELATIONSHIP BETWEEN FOOD SECURITY, ENVIRONMENTAL SAFETY AND SUSTAINABLE DEVELOPMENT Nishtha and Shanza Baig	415

812	IMPORTANCE OF AQUAPONICS IN AGRICULTURAL TECHNOLOGY Shivangi Pandey, Moinuddin, Suneeta Singh, Ankit Semwal and Shubanshu Karasi	415
813	Root-knot Nematode, <i>Meloidogyne incognita</i> Pest of Vegetables and its Eco-friendly Management Amir Khan ^{*1} , Mohammad Haris ² , Gufran Ahmad ² , Adnan Shakeel ² and Abrar A. Khan ¹	416
814	Applications of Eco-Friendly Natural Dye on Wool Fibers Using Combination of Natural and Chemical Mordants Shyam Vir Singh	416
815	Biomass and productivity of Khejri (<i>Prosopis cineraria</i>) based agroforestry systems in arid part of India. SANDEEP ARYA*, AND O. P. TOKY	416
816	Verification of Fertilizer Prescription for Targeted Yield of Soybean [<i>Glycine max</i> (L.) Merrill] in Vertisol S.S. Baghel, Pradip Dey and R.K. Sahu	417
817	Evaluation of the Influence of Certain Types and Doses of Organic Manures on Seed Germination and Seedling Growth of Foxglove (<i>Digitalis purpurea</i> L.) at Temperate Hill Ranges of Bharsar, Uttarakhand Bhatt, N. ¹ , Singh, K.C. ^{*1} , Goswami, G. ¹ , Haobijam, J.W ² .	417
818	IN VITRO REGENERATION ABILITY OF TUBEROSE (<i>Polianthes tuberosa</i> L.). ¹ ABHINASH MOIRANGTHEM, ² SOUMEN MAITRA, ³ PUNABATI HEISNAM AND ³ M BISWAPATI DEVI	418
819	Studies on Honeybee, <i>Aphis mellifera</i> L. and plant biodiversity including Agroforestry in semi arid region of Rajasthan SK KHINCHI, SL SHARMA, SP SINGH	418
820	FLORISTIC DIVERSITY, ABOVEGROUND BIOMASS AND CARBON STOCK IN COFFEE-BASED AGROFORESTRY SYSTEM AND ADJOINING NATURAL FORESTS OF CENTRAL WESTERN GHATS, INDIA B. G. Nayak ¹ , Raju Chavan ² , Devagiri, G. M. ³ , Hareesh, T. S. ⁴ and Sathish, B. N ⁴	419
821	Agricultural waste biomass utilization for energy production through gasification Sunil L Narnaware and N L Panwar	419
822	Pusa concentric storage structure in District Kanpur Nagar (U.P.) <u>Nimisha Awasthi</u> , Anjali Sahu*, and Arun Kumar Singh	420
823	Effect of direction of sowing on growth and yield of Wheat (<i>Triticum aestivum</i> L.) Cultivars Ravikesh Kumar Pal ^{1*} , A. K. Singh ² , Pramod kumar ³ , Prithvi raj ¹ and Shashank Tayagi ⁴	420
824	Protective effects of Zinc with dietary nutrients on biochemical and hematological parameters of albino rats intoxicated with Cadmium chloride Shivani yadav* ^a , Ruhi Tomar ^b , D.K Chauhan ^c , Kavita Verma ^d , Divya Singh ^e	421
825	Suitability of turmeric varieties against fungal diseases in Cuddalore district, Tamil Nadu P.T. Sharavanan	422
826	Enhancement of knowledge level of paddy growers on ecofriendly cultivation practices by farmer’s field school approach P.T. Sharavanan*	422
827	Assessment of Academic stress on mental health of college students Sangya Singh	423
828	The effect of soaking and germination treatments on nutritive, antioxidant activity, and bioactive composition of quinoa (<i>Chenopodium quinoa</i> Willd.) Priyanka Thakur*, Krishan Kumar, Divya Chauhan, Qurat Ul Eain Hyder Rizvi, Sumaira Jan, Naseer Ahmed, and Tajendra Pal Singh	423
829	Security and Nutritional Safety: A Challenge Ahead	423

	Jasveer Singh ¹ and Rohtash Kumar ²	
830	Integrated based nitrogen on the growth, yield, quality and economics of aromatic rice and their residual result on succeeding lentil under rice-lentil crop sequence ¹ Punabati Heisnam, ² Abhinash Moirangthem, ¹ Priyanka Irungbam, ¹ Ph. Arunkumar Singh, ¹ Bapsila Loitongbam and ³ Asish Singha Roy	424
831	Performance of medicinal and aromatic plants as intercrops in Kinnow orchard *Manpreet Singh ¹ and Dr. Kanwaljit Singh	425
832	Geospatial modelling of changes in land use/land cover dynamics in Part of Majhagawan Block using geo-informatics Ravi Chaurey ¹ , Santosh Kumar ² , Ajay Kumar ³	425
833	SUSTAINABLE AGRICULTURE AND RESOURCE MANAGEMENT: PROSPECTS AND CHALLENGES MANJEET SINGH	426
834	Doubling the Farmers’ Income by adopting an innovative Mushroom Cultivation Practices. *Sunil Kumar ¹ , Sushil Kr Sharma ¹ , Arbind Kr Verma ¹ , Sandeep Rastogi ¹ and P K Rai ²	426
835	Assessment of Integrated Pest Management Technology in Bt. Cotton at Farmers’ Fields through On Farm Testing (OFTs). Sunil Kumar ¹ , Bajrang Lal Ola ¹ , Sandeep Kr Rastogi ¹ , Sushil Kr Sharma ² , BS Rathore ³ and P K Rai ⁴	427
836	Little millet (<i>Panicum sumatrense</i>) varieties performance to different levels of fertility in rainfed mid hills of Himalaya. Ajay Kumar ¹ , Arunima Paliwal ¹ , Amit Kishore ¹ , Sukanya TS ² , Shikha ³ SB Singh ⁴	427
837	POLYSACCHARIDE PRODUCTION AND NITRATE REDUCTION BY BLACKGRAM RHIZOBIAL STRAINS RELATING TO NITROGEN FIXING ABILITY Diptimayee Dash*	428
838	Genetic parameters and association study of the mutant M ₄ population of <i>Pogostemoncablin</i> Benth. created through induced mutation. Sudin Kumar Pandey ^{*a,b} , Neelav Sarma ^{a,b} , Manabi Paw ^{a,b} , Sangeeta Bhandari ^b , Twahira Begum ^{a,b} Mohan Lal ^{a,b}	429
839	Chemical profiling of essential oil among germplasm of <i>Zingiber officinale</i> Roscoe collected from Northeast India Twahira Begum ^{*1,2} and Mohan Lal ^{1,2}	429
840	Assessment of variability and correlation studies among 150 germplasm of <i>Zingiber officinale</i> Roscoe collected from Northeast India Twahira Begum ^{*1,2} and Mohan Lal ^{1,2}	430
841	Molecular study using RAPD and ISSR marker based on selection of M ₄ population of <i>Pogostemon cablin</i> benth.: Through Induced mutation. Sudin Kumar Pandey ^{*a,b} , Neelav Sarma ^{a,b} , Manabi Paw ^{a,b} , Sangeeta Bhandari ^b , Twahira Begum ^{a,b} , Mohan Lal ^{a,b}	430
842	STANDARDISATION, SHELF LIFE STUDY AND NUTRIENT COMPOSITION OF THE BEETROOT ENRICHED KODO MILLET PASTA SAROJANI J K ^{1*} , SUVARNA C H ² AND SNEHA S	431
843	POTENTIAL OF PSEUDOSTEM OF <i>Musa Bulbasiana</i> Colla AS A POTENTIAL NATURAL HEALTH SUPPLEMENT Priyanka Bhattacharyya	431
844	Development and Performance Evaluation of Solar Operated Plot Thresher for Chickpea Naveen Kumar* and Ajay Kumar Sharma ¹	432
845	INTREGATED NUTRIENT MANAGEMENT Jay Nath Patel ^{*1} , Mohd Shah Alam ¹ , Durgesh Kumar ²	432

846	Aquaculture: present and future Mohd Shah Alam* ¹ , Jay Nath Patel ¹ , Muzeev Ahmad ² , Khursheed Alam ²	433
847	Role of Indigenous Technical Knowledge (ITK) for Sustaining Grassroots Innovations Kawita Bhatt ¹ , Pooja Karki ² , Piyush Choudhary ³	433
848	Performance of <i>Rhizobium</i> strains on available nutrients and rhizobial population of pigeonpea in Vertisol Kavita Soni , R.K.Sahu*, Bablu Yaduwanshi , N.G. Mitra and S.S. Baghel	433
849	Effect of <i>Rhizobium</i> inoculants on growth stages and yield of pigeonpea in Vertisol Kavita Soni , R.K.Sahu, S.S. Baghel*, Bablu Yaduwanshi and N.G. Mitra	434
850	Development of avirulence genes-based multiplex PCR to identify black rot disease in cauliflower <u>Amit K. Kesharwani</u> ^{1,2*} , Dinesh Singh ¹ , Anupama S. Avasthi ²	434
851	Role of AMMI and GGE biplot in developing of new varieties in changing climatic conditions Atul Loyal ¹ , Naval Kishore ² S. K. Pahuja ¹	435
852	Minimum data set to improve seed and fodder yield in Oat Priyanka *, V.K. Sood, Sawan Kumar, Amit Rana and Sanjay Kumar Sanadya	435
853	Impact of Heights on Growth, Yield and Quality of Mango cv. Amrapali Amit Raj ¹ , Goutam Mandal ¹ , Sanjay Sahay ² and Ravindar Kumar ²	436
854	Determination of Aquifer parameters by using AQTESOLV-Software Dimple*, P.K. Singh and K.K. Yadav	436
855	ROLE OF SOCIAL MEDIA IN AGRICULTURE MARKETING Aafreen Malik ¹ and Mohammad Aslam Ansari ²	437
856	Climate Resilient Technologies for Sustainable Food Production in India D.Balu ¹ , M. Kavaskar ² D.Vengatesan ² and E.Suriyapriya ¹	437
857	EFFECT OF FOLIAR NUTRITION ON GROWTH AND YIELD OF COTTON <u>THIRUPPATHI, M*</u> , S. SELVAKUMAR*, R. REX IMMANUEL*, A. SIVARAMAN** AND G. ASHOKA CHAKRAVARTHY*	438
858	EFFECT OF BIOFERTILIZERS AND INORGANIC FERTILIZER ON YIELD ATTRIBUTES AND ECONOMICS OF BLACKGRAM (<i>Vigna mungo</i> L.) Thiruppathi,M*,Gudapati Ashoka Chakravarthy** R. Rex Immanuel*** and S. Selva Kumar****	438
859	Climate Change and Smart Agriculture Food Production Safety Management in India an Analysis Kalirajan, V., Sujaivelu. T And V.Balamurugan	439
860	ADOPTION LEVEL OF SUGARCANE CULTIVATION PRACTICES BY THE SMALL FARMERS IN CUDDALORE DISTRICT Balamurugan .V, Kalirajan .V and T.Balakrishnan	439
861	Constraints Encountered by the Mango Growers in Mango Cultivation and Marketing V. Sakthivel,* C. Pon Alagammai**and Dr. K. Kanagasabapathi***	440
862	Analysis on Knowledge Level of Farm Youth onUzhavan App(Krishi App) in Thanjavur District of Tamil Nadu M. Kavaskar ¹ and R.Booma ²	441
863	Impact of Citrus based agroforestry systems on above ground, below ground biomass and carbon sequestration. Aarti P Deshmukh, Lalji Singh , V. M. Ilorkar and P. D. Raut	441
864	Partial substitution of maize mineral fertilization with some organic and bio-fertilizers Huda M. M. Elmasry	442

865	Impact of Agricultural Technology Management Agency (ATMA) on production and productivity of paddy and wheat crops among different categories of farmers under Gwalior district in Madhya Pradesh Rahul Singh Tomar, Rahul Singh sikarwar, and Anam Khan	442
866	Phosphorus Transformation in Rock Phosphate Fertilized Soil Applied with Phosphorus Solubilizing Bacteria and Lime Nakeertha Venu*, N. Surbala Devi, Athokpam Herojit Singh, K. Nandini Devi and N. Gopimohan Singh	443
867	STUDIES ON RICE BLAST INCITED BY <i>Pyricularia grisea</i> (Cooke) Sacc. IN TELANGANA STATE K. Aravind ¹ , B. Rajeswari ¹ , T. Kiran Babu ² , S.N.C.V.L. Pushpavalli ³	444
868	Assessment of Workplace Hazards of Agro-Industrial Workers Aman, A K Shrivastava* and A K Dave	445
869	Workplace and Occupational Health Studies of Sugar Cane Industry Yamini Tekam, AK Shrivastava*, DK Rai, AK Dave	445
870	Standardization of protocol for genomic DNA extraction in <i>Fraxinus xanthoxyloides</i> a cold desert species grown in Western Himalayas Akshit Kukreti ^{1*} , Manisha Thapliyal ² , Santan Barthwal ³ , Neelam Kurmanchali ^{4*} and Laxmi Rawat ⁵	446
871	Effect of IBA and Saccharides on rooting and growth in stem cuttings of pomegranate (<i>Punica granatum</i> L.) cv. Bhagwa Pratibha	446
872	PBS1 Decoy system in Plant Diseases Resistance Mohamad Ayham SHAKOUKA	447
873	Discussion of some common fungal post harvest diseases of garlic in Manipur Rimamay Konjengbam ^{1*} , N Sunita Devi ² , Takhellambam Julia ³ and Kota Chakrapani ⁴	448
874	Determination of Genetic relatedness among Common Bean Genotypes of Northern India Nancy Gupta ¹ , Sajad Majeed Zargar ² , R. K. Salgotra ¹	448
875	Impact Analysis of Drip- Fertigation on Growth and Yield attributes of Tomato (<i>Lycopersicon esculentum</i> Mill) K.S.Yadav*, and Dr Mamta Singh	449
876	Effect of Integrated Nutrient Management on Growth and Yield Parameters of Pomegranate (<i>Punica granatum</i> L.) cv. Super Bhagwa in Southern Rajasthan S. Dadheech, RaviKant Sharma and C. M. Yadav*	449
877	INNOVATIVE JALKHUND AND MICROIRRIGATION IN NORTH EASTERN INDIA <u>Megha Raghavan</u> and A S Mailappa*	450
878	Qualitative Dermatoglyphics Analysis In Deaf Mute Children Of Meerut Ruhi Tomar ^{*,a} , Shivani Yadav ^b , D.K Chauhan ^c , Juhi Aggrawal ^d	451
Sl. No.	<i>Cordyceps militaris</i> L.: Chemical compounds and its opportunities Shivangi Pandey, Suneeta Singh, Moinuddin, Shubhanshu Karasi, Ankit Semwal	451
	Current Scenario Bhimal Tree (<i>Grewia optiva</i> L.) as Forage in The Mountain/Hilly Areas of Uttarakhand Ankit Semwal, Moinuddin, Suneeta Singh, Shivangi Pandey, Pankaj Nautiyal	452
879	Protected Agricultural Technology for Growing of Vegetables in High-Tech Nursery Ankit Semwal, Moinuddin, Suneeta Singh, Shivangi Pandey, Pankaj Nautiyal	452
880	Economic yield assessment in <i>Digitalis purpurea</i> L. under different levels of farm yard manure under high hills of Uttarakhand Sonali Rana, Suneeta Singh and B. P. Nautiyal*	453

881	Effect of Phosphorus Fertilization Inorganic Phosphorus Fractions and Available Phosphorus of Soils Tahir Ali*, Ananta G. Mahale* and Moinuddin**	453
882	Impact of Climate Change on Agriculture Owais Bashir, Tahir Ali, Z.A. Baba, Moinuddin* and Mohammad Nowmaan**	454
883	Thematic Strategy and Indicators for Soil Protection Owais Bashir, Tahir Ali, Z.A. Baba, Moinuddin* and Mohammad Nowman**	455
884	Soil protection and its Strategies – how to bridge between science and decision making Owais Bashir, Tahir Ali, Z.A. Baba, Moinuddin* and Mohammad Nowman**	455
885	Current Scenario and Issues of Organic Farming in India Owais Bashir, Tahir Ali, Z.A. Baba, Moinuddin* and Mohammad Nowmaan**	456
886	Flax fibre and blended yarn characteristics Iramma V. Goudar and Dr. Sadhana D. Kulloli*	457
887	EXTRA FLORAL NECTARIES: THEIR STRUCTURE AND DISTRIBUTION SONU KUMARI	457
888	Genetic assessment of newly developed maize inbreds for yield and its attributes in different agro-climatic conditions *Gaurav Sharma ¹ , Uttam Chandel ² , Sawan Kumar ¹ and Satish Kumar Guleria ³	458
889	Abiotic stress and its management Harpreet Singh ¹ , Om Prakash Yadav ²	458
890	Structure and Pattern of Labour Utilization in Crop Activities in Sub Humid and Humid Southern Plain Region of Rajasthan Arjun Singh Rajput ^{1*} , Vikalp Sharma ² , P. S. Sekhawat ³ and Latika Sharma ⁴	459
891	Minimum data set to improve seed and fodder yield in Oat Priyanka*, V.K. Sood, Sawan Kumar, Amit Rana and Sanjay Kumar Sanadya	459
892	Genetic variability and association studies of marketable traits in gladiolus (<i>Gladiolus hybridus</i> Hort.) in Bundelkhand Conditions Rakesh Kumar ^{1*} , Ajay Kumar Singh ² , Krishna Singh Tomar ³ and Amit Kanawjia ⁴	460
893	Impact of Front Line Demonstration of Zinc Sulphate in yield of rice (<i>Oryza Sativa</i> L.) under the zinc-deficient area of hills Shikha ^{1*} , A.G.Yewale ² , Arunima Paliwal ³ , Ajay Kumar ⁴	460
894	Impact of Front Line Demonstration of Zinc Sulphate in yield of rice (<i>Oryza Sativa</i> L.) under the zinc-deficient area of hills Shikha ^{1*} , A.G.Yewale ² , Arunima Paliwal ³ , Ajay Kumar ⁴	460
895	Climate change and its impact on Indian Agriculture Asif. M. Rather ^{1*} , S. Narayan ¹ , T. A. Bhat ¹ , K. Hussain ¹ , M. Tariq ² , Ummer Atta ² , Nawaz A. Ganaie ¹ , M. A. Hajam ³ , A. A. Malik ¹ , Anil Kumar ¹ , M. A. Wani ⁴ , S. A. Mir ⁵	461
896	Response of Liquid Biofertilizer, Plant Geometry and Different Levels of Phosphorus on Growth and Yield of Green Gram (<i>Vigna radiata</i> L.) Schchida Nand Singh, Vikram Singh, Moinuddin*, Manoj Shukla** and Sharad Pandey**	461
897	FISH LEATHER: A VALUABLE RESOURCE FOR TEXTILE AND FASHION INDUSTRY Shalini Rukhaya ¹ , Mona Verma ² and Saroj S. Jeet Singh ³	462
898	Triacontanol induced counteractive mechanisms against salt toxicity in Indian mustard Shaistul Islam and Firoz Mohammad*	463
899	BIO-BASED FAUX LEATHER: ANIMAL AND ECO-FRIENDLY ALTERNATIVE Diksha Bisht ¹ , Mona Verma ² and Dr. Saroj S. Jeet Singh ³	463
900	DOUBLING THE FARMER INCOME THROUGH INNOVATIVE APPROACH SWATI KUMARI ¹ AND RITU KUMARI ²	464

- 901 **CONTRIBUTION OF COVER CROPS TO WEED MANAGEMENT IN SUSTAINABLE AGRICULTURAL SYSTEMS** 464
Soni Singh, Tarkeshwar*, Kamlesh Kumar, Govind Mishra and Ravi Prakash Chaudhary
- 902 **EXPLOITATION OF DIVERSITY IN WHEAT TO IMPROVE GRAIN YIELD, CLIMATE RESILIENCE AND NUTRITIONAL VALUES USING MODERN BREEDING APPROACHES** 465
Tarkeshwar^{1*}, Soni Singh¹, Kamlesh Kumar², Ravi Prakash Chaudhary¹, Govind Mishra¹, Mohit Yadav² and Mohammad Salman¹
- 903 **NEW PROTOCOL FOR ESTIMATING POTENTIALLY AVAILABLE PHOSPHORUS IN ORGANICALLY MANAGED ACIDIC SOILS** 466
Pritisha Patgiri* and Sanjay-Swami
- 904 **Digital Learning: The new face of Education in the course of Covid-19 pandemic** 466
Dipankar Saikia^{*1}, Bidyut P. Gogoi², Abhijit Das³ and Manisha Barman⁴
- 905 **Digestive, metabolic and antioxidant enzyme activities of *Labeo bata* (Hamilton, 1822) adults fed with dietary neem oil and nonylphenol** 467
Prasanta Jana^{1*}, Gour Hari Pailan², Narottam Prasad Sahu¹, Subrata Dasgupta², Saumya Kanti Ray², Bijay Kali Mahapatra²
- 906 **Developing novel NPK Biofertilizer Consortium for Minor Millets** 467
R. Thamizh Vendan and T. Boobalan
- 907 **Diversity and Functionality of Seed Vected Bacterial Endophytes in *Triticum aestivum* L. across Boundaries of Cultivars and Ecology** 468
Jogdande Sai Prasad, Archana Suman
- 908 **An ethno botanical study of medicinal plants used to treat gastrointestinal ailments of district Kupwara of Jammu and Kashmir.** 468
Aadil Abdullah^{*1}, Dr. Syed Aasif Hussain Andrabi²
- 909 **Response of Integrated Nutrient Management on quantitative and qualitative parameters of Ber (*Ziziphus mauritiana* L.) cv. Apple ber** 469
¹EESHWAR SAHU, ²SEVAN DAS KHUNTE, AND K.K. YADAV
- 910 **Integrated Management of Diamondback Moth in cabbage in western plateau of Jharkhand Sub Zone V** 469
Nazrussalam, and D. N. Singh
- 911 **CARBON CREDIT: A BOON FOR THE ENVIRONMENT** 470
Arpita Grover¹, Mona Verma² and Dr. Saroj S. Jeet Singh³
- 912 **Assessment of physical and chemical effect of mutagenesis on germination, pollen fertility and plant survival in M₁ generation of wheat (*Triticum aestivum* L.)** 470
AMIT RANA^{1*}, VIJAY RANA^{1,2}, PRIYANKA¹, CHETAN GUPTA¹, RUPALI CHOUDHARY¹ AND A. K. SARIAL¹
- 913 **Physio-chemical analysis of quality, evaluation and development of Bottle gourd lemon mint squash** 471
^{1*}Ashish Kumar
- 914 **Impact of salt stress on the growth, morphological as well as physiological attributes of *Cicer arietinum* and alleviation potential of microbial inoculants to overcome salt stress** 471
ZEENAT MUSHTAQ*, BASIT GULZAR AND SHAHLA FAIZAN
- 915 **Isolation and characterization of endophytic bacteria in rice Chindam swathi., Dr. Bharati N. Bhat., Dr. G. Uma Devi., Dr. S. Triveni and Dr.S.N.C.V.L. Pushpavalli** 472
- 916 **Effects of Silicon on Growth, Yield and Quality Attributes of *Artemisia annua* under Copper stress** 472
Andleeb Zehra*, Sadaf Choudhary, Mohammad Mukarram, Kaisar Iqbal Wani and Tariq Aftab

917	Breeding for Salt Tolerance: Conventional and Molecular Approaches Rubina Khan*, Dr. S. S. Punia ¹	473
918	A Review on Important Sorghum Insect Pests: Biology, Ecology, and Management Rajendra Kumar ¹ and Sakshi Saxena ²	473
919	Effect of biopolymer treatment on dyeing of cotton fabric with natural dye Mona Verma* and Saroj S. J. Singh	474
920	Studies on Genetic diversity Analysis in Rice bean [<i>Vigna umbellata</i> (Thunb.) Ohw Ohashi] Germplasm M. Singh ^{1*} , V. Kumar* and R. Arya ^{2*}	474
921	Doubling Farmers Income by Tissue Culture Approaches R.A. Jadhav	475
922	Nutraceutical analysis in faba bean (<i>Vicia faba</i>) on variability and yield S. K. Yadav*, H.L.Raiger, Ravi Kumar ¹ and N.K. Jajoriya	475
923	Variation in hematological parameters during gonadal maturity and breeding of snow trout (<i>Schizothorax richardsonii</i>) Uzma Siddiqui ^{1*} , Amrita Rani ³ , H.C.S Bisht ¹ and Nityanand Pandey ²	476
924	Response of different Methods of sowing and organic manures on growth and yield of Wheat (<i>Triticum aestivum</i> L.) Bandi Gnana Prakash ^{1*} , Joy Dawson ² , Thomas Abraham ² and Mayur ³	477
925	Forest Fire Management in Uttarakhand Rushil Kartikeya Srivastava and Moinuddin	477
926	Modern Concept of Organic Farming in India Albin Pious and Moinuddin	478
927	Recycling: A Steps towards Sustainable Development Neelam Saini ¹ , Saroj Yadav ² , Neelam M. Rose ³ and Mona Verma ⁴	479
928	Bee vectoring technology the novel innovation to deliver organic pesticides to crops Sakshi Saxena ¹ and Rajendra Kumar ²	479
929	Comparison of Residual Effect of Different Sources of Zinc in terms of Apparent Recovery Efficiency in Rice-Maize Cropping System Aswathy. S. Nair *G. Padmaja	480
930	Assessment of carbon sequestration under different agroforestry species M. D. Dhamde, Maya M. Raut, P. D. Raut, V. M. Ilorkar and S. S. Balpande	481
931	Impact of fermentation on nutritional and anti-nutritional components of black soybean (<i>Glycine max</i> L.) Divya Chauhan*, Krishan Kumar, Naseer Ahmed, Priyanka Thakur, Qurat-Ul- Eain-Hyder Rizvi	481
932	Role of Rural Women in Entrepreneurship Neelam Kumari ¹ and Pankaj Yadav ²	482
933	Organic Farming: A Way to Residue Free Agriculture Dangi Pooja Arun ¹ and Neelam Kumari ² and Dharmender Singh ³	483
934	Climate Change Impact and its Consequences on Society and Environment Neelam Kumari ¹ , Dangi Pooja Arun ² and Naaz Bano ³	483
935	Agricultural e-commerce framework for India Dr. Anamika Tiwari ^{*1} and Mrs. Shubhda Pandey ²	484
936	Farmers' Perception about Climate Change: A prerequisite for appropriate adaptation measures at farm level Neha ¹ and Mohammad Aslam Ansari ²	484
937	Performance Evaluation of Power Operated Paddy Seeder for Dry and Wet Seeding U.K.Dhruw ¹ , D.K. Roy ² and A.K.Verma ³	485

938	Correlation and Path co-efficient Studies in three diverse species of sesame under mid hill Condition of North West Himalayas ¹ Ritika Singh and ² Neha Banta	486
939	Nutritional Quality and Health Benefits of Vegetables: A Review Madan Kumar Jha	487
940	Transcript-level differential candidate gene expression analysis & Characterization of Physiological Responses among Minor millets & rice (<i>Oryza sativa</i> L.) under water stress. Pooja Kathare	487
941	Biochemical composition of pulse crops indigenous to different zones of North India ^{*1} Neha Banta, ² Ritika Singh and ³ K. Mohini	488
942	Safe Methods for Weed Control in Vegetable Crops: Challenges, and Opportunities: Review Smt. Shilpa Kaushik ¹ , Dr. Amit Shukla ² and Madan Kumar Jha ³	488
943	Work place and Occupational Health Studies of Sugar Cane Industry Yamini Tekam, AK Shrivastava, DK Rai, AK Dave	489
944	Enzyme activities during rice straw decomposition under inoculation of lingo-cellulolytic microbial consortia in vertisol Swarnima Shrivastava ^{1*} , S.K.Verma ¹ , A.K. Patra ² and M.C. Manna ²	489
945	Kisan Call Centre: A New Vista for Indian Agricultural Extension System D.K.Shrivastava and Mr. Madan Kumar Jha	490
946	Health Benefifits of Uses and Applications of <i>Moringa oleifera</i> in Bakery Products Dr.Nivedita Pathak	490
947	A Review on Significance of Pollination Services Ranjeet Kumar, Himani Saini and Sangeeta Verma	491
948	Review Paper on the Role of Somatic Hybridization in Crop Improvement Sadhana Saha	491
949	Methods for Weed Control in Vegetable Crops: Challenges, and Opportunities: Review Vandana Ekka and Madan Kumar Jha	492
950	Performance Evaluation of Different Seed Bed Configurations in Chickpea Cultivation in Mandsaur district of Madhya Pradesh Rajesh Gupta ^{1*} , A.L., Basediya ² and Ajeet Sarathe ³	493
951	Ethylene supplementation protect photosynthetic performance from salt toxicity by through increased nitrogen and sulfur assimilation and modulating defense system in mustard <u>Badar Jahan</u> [*] , Nafees A. Khan	493
952	Evaluation of various insecticides for the management of mustard aphid, <i>Lipaphis erysimi</i> (Kalt.). Manjeet Singh ^{1*} , B. K. Kang ¹ and Smriti Sharma ¹	494
953	Adaptability response and photosynthetic potential of stress-resilient sorghum [<i>Sorghum bicolor</i> (L.) Moench] to high salinity Jayanti Tokas [*] , Himani Punia, Satpal, Sarita Devi and Neeraj Kharor	495
954	Upscaling and Comparison of Beer Production by <i>Saccharomyces cerevisiae</i> Fermentation of Sweet Sorghum Keshani [*] and Jasmine Kaur	496
955	Review On Early Blight (<i>Alternaria</i> spp.) of Potato Disease and its Management Options Chetana Jangde ^{*1} , C.S.Shukla ² , H.K.Singh ³ and Smriti Dhruw ⁴	496
956	Indigenous Technical Knowledge for Sustainable Agriculture	497

Sanjana Shrivastava, Sheetal Patel, Prashant Singh Kourav

957	Effect of Potassium Doses on Rice (cv. Pusa Basmati 1) Yield, Economics and Different forms of K in Vertisols of Madhya Pradesh <u>Bharti Parmar*</u> , EktaJoshi, R.H. Wanjari	497
958	Popularization of medicinal plant-based Agroforestry practices for higher income to the farmers and conservation of medicinal plant resources Arun Kumar Shukla ¹ , K. K. Chandra ²	498
959	Measuring total factor productivity in dairying in arid western Rajasthan Dropati Saran ¹ , Madhu Sharma ² , Rajesh Sharma ³ and Hemant Sharma ⁴	499
960	Nutri-smart village: Taking steps toward nutrition security Arvind Preet Kaur and Manisha Bhatia	499
961	Comparative Economics of Paddy Cultivation by Transplanting, Drilling and Broadcasting Methods of Paddy Cultivation in Gadchiroli District of Maharashtra A S Tingre , N V Shende and R D Vaidkar	500
962	Effect of Potassium Doses on Rice (cv. Pusa Basmati 1) Yield, Economics and Different forms of K in Vertisols of Madhya Pradesh <u>Bharti Parmar*</u> , EktaJoshi, R.H. Wanjari	500
963	Effect of seaweed extract on growth performance of chilli (<i>Capsicum annum</i> L.) in Alfisols of Konkan (M.S.). V.D. Kapse, K. P. Vaidya, M. C. Kasture N. B. Gokhale, B. R. Salvi and J.S. Dhekale	501
964	Impact of seaweed extract on yield of chilli (<i>Capsicum annum</i> L.) in Konkan region of Maharashtra V.D. Kapse, K. P. Vaidya, M. C. Kasture N. B. Gokhale and S. B. Dodake and S.S. More	502
965	Effect of new formulation of micronutrients on growth, yield and economic feasibility of wheat in sandy loam soil of Western Uttar Pradesh ^{1*} Anand Singh, ² U.P. Shahi, ¹ Omkar Singh, ¹ Prashant Deo Singh, ¹ Shakti Om Pathak	502
966	Agri Business Incubator, SKUAST-Jammu: A New Paradigm for Young Agri-Entrepreneurs Jyoti Kachroo	503
967	Genetic Diversity Assessment of Teak (<i>Tectona grandis</i> Linn. F.) clones of Clonal Seed orchard, Odisha H. Nayak ^{1*} , A. Sinha ² , N. Bhol ³ and Jai Kumar ⁴	504
968	Carbon trading: a viable option for mitigating climate change Monika Menia*	505
969	Rapid human population- root threat to biological diversity Monika Menia*	505
970	Vertical farming-an approach towards sustainable agriculture Monika Menia ^{1*} , Jyoti Sharma ² and Meenakshi Attri ³	506
971	Rainfall variability analysis of onset of monsoon in different agro climatic regions of Eastern Uttar Pradesh AJIT SINGH ^{1*} , A.K. SINGH ² , S.C. BHAN ³ , and S.R. MISHRA ⁴	506
972	Integrated Pest Management: A boon to farmers Rabindra Prasad, A. Narayan, Neeraj Kumar and G.S. Giri	507
973	Insight into phenotypic screening of tossa jute against salinity stress M.M. Mukul*, N. Akter and M.G. Mostofa	507
974	Performance of maize (<i>Zea mays</i>) as influenced by drip irrigation schedules and nitrogen levels Y. DEEPTHI KIRAN, V. SUMATHI AND G. PRABHAKARA REDDY	508
975	Relative performance of wheat (<i>triticum aestivum</i>) varieties under different residue management and tillage systems	508

Kapil malik^{1*}, O. P. Lathwal¹, abhliash², A. K. Dhaka¹ and pankaj dah iya²

976	The wisdom for dual role of rural women in household and papad making enterprise for their livelihood in bihar state Rambha kumari * & Dr. Shishir kala **	509
977	Bael-a medicinal tree & its conservation an dreligious value in india K.P.Dwivedi,R.P.Bain,andA.K.Tomar	510
978	APPLICATION OF INFORMATION AND COMMUNICATION TECHNOLOGY IN AGRICULTURE Gargi Paliwal ¹ ; Dr.D.K. Singh ² ; Samarjeet Singh ³	510
979	APPLICATION OF INFORMATION AND COMMUNICATION TECHNOLOGY IN AGRICULTURE Gargi Paliwal ¹ ; Dr.D.K. Singh ² ; Samarjeet Singh ³	511
980	Present Status, Problem and Prospect of Duck Farming in Kolhan Region of Jharkhand Pankaj Seth ¹ , Sushma Lalita Baxla ² and Jagarnath Oraon ³	511
981	The modernization Pumped hydro Energy Storage small Hydro Power plant Ekta Sharma ¹ , Shishir Kumar Kaushal ² and Ratnakiran Wankhade ³	512
982	Effect of GA ₃ on flower yield and quality of different varieties of perennial Chrysanthemum Dipmala P. kedar* , Dipali Chatse, Dr. D. M. Panchbhai	512
983	Assessment of the genetic variability for resistant starch content and its association with viscosity parameters in rice Neha Singh ^{a,b} , Haritha Bollinedi ^{a*} Kusuma Kumari Panda ^b , Gopala Krishnan S, Vinod KK, Bhowmick PK, Nagarajan M, Ellur RK & Singh AK	513
984	Synthesis of azomethines and β -lactams of aza heterocycles and antifungal evaluation against <i>Rhizoctonia solani</i> DikshaVerma ^a , Sunita Sharma ^b , Tanvi Sahni ^a , Amanpreet Kaur ^a and Sukhmanpreet	513
985	Development of Papaya Flavoured Synbiotic Shrikhand N. A. Suryawanshi, S. S. Ramod, Y. N. Patil, <u>V. B. Kadav</u> and V. S. Dandekar	514
986	Soil and Water Characteristics of North Bihar Fish Ponds in relation to Fish Production S. S. Prasad, Shankar Jha, Sanjay Kumar Singh, S. P. Singh and Sudhir Das	514
987	Status of sheath blight and sources of resistance in rice landraces Jameel Akhtar ^{1*} , Ravinder Pal Singh ¹ , B R Meena ¹ Pardeep Kumar ¹ , Rakesh Singh ² VC Chalam ¹ and Kuldeep Singh ³	515
988	Achievements in Quality Improvement in Temperate Fruit crops through Molecular Approaches Ikra Manzoor ¹ , K.M. Bhat ¹ , A.R. Malik ¹ and Usma Jan ²	515
989	Post-harvest management for improving shelf life of banana fruit Abhay Mankar ¹ , K. Karuna ^{2*} and Ruby Rani ²	516
990	Analysis of soil samples for different physico-chemical properties in middle IGP of Bihar Basant Kumar Sharma ¹ and M. Shamsul Islam ²	516
991	Forest Fire Management: A review Ranjeet Kumar, Richa Sharma, Krishna Kumari and Sangeeta Verma	517
992	Effect of Cutting Length and Cutting Diameter on Macropropagation of <i>Melia composita</i> ¹ Sakeena Gul Niazi*, ² Dinesh Kumar and Ashok Kumar	517
993	Heat induced decreased activity of nitrate reductase and its impact on yield under late sown condition in three genotypes of wheat (<i>Triticum aestivum</i> l). Kamla Jakhmola*, Sobha, Shweta Sahni	518
994	Chromatographic and spectroscopic analysis of heartwood extract of <i>Pterocarpus</i> species	518

3rd International Conference on “Global Initiative in Agricultural, Forestry and Applied Sciences for Food Security, Environmental Safety and Sustainable Development (GIAFAS-2021)”

Kamal Mishra¹, S. S. Bisht¹, K. K. Pandey¹, Girish Chandra²

995	Effect of different concentrations of kinetin on <i>in vitro</i> shoot multiplication of bamboo	518
	Chavan N. S., Chavan N. R., and Kale Sonam S.	
996	Association mapping for different phenotypic traits using elite sorghum [<i>Sorghum bicolor</i> (L.) Germplasm lines	519
	Chavan N. R., Kale Sonam S., Chavan N. S. and Sonwane V. R.	
997	Isolation, Characterization and Genetic Diversity Analysis of <i>Trichoderma</i> Isolates Isolated from Gandheli, Aurangabad Region	519
	Kale Sonam S., Chavan N. S., Chavan N. R., and Tapse S.	
998	Development of synbiotic lassi by using buffalo milk	520
	S. G. Jagadale, Y. N. Patil, S. S. Ramod, V. B. Kadav and V. S. Dandekar	
999	Development of Papaya Flavoured Synbiotic Shrikhand	520
	N. A. Suryawanshi, S. S. Ramod, Y. N. Patil, V. B. Kadav and V. S. Dandekar	
1000	Preparation of Milk Shake By Using Jaggery and Date (<i>Phoenix dactylifera</i> L.)	520
	S. V. Surve, N. T. Chorage, Y. N. Patil, A. J. Mayekar and V. S. Dandekar	
1001	Detection and Isolation of Seed Mycoflora of Lablab bean, Horse gram and Cowpea	521
	Y K Nirgude, R R Rathod, U R Phondekar, R R Kalaskar and U V Mahadkar	
1002	GIS Based Decision Support Systems in Agriculture	521
	Mahipal Singh Choudhary	
1003	Molecular Genetic Analysis for YMV Resistance in Blackgram (<i>Vigna mungo</i> L. Hepper)	521
	K. R. SARAVANAN*, P. KARTHIKEYAN, S. VENNILA ³ , and S. SUGANTHI ⁴	
1004	Compatibility of Essential Oils With Entomopathogenic Fungi; A Potential Tool For Insect-Pest Management	522
	Renu Pandey* ¹ and Sapna Tiwari ²	
1005	Breeding for disease resistance in Bamabara groundnut	522
	Chitti Bharatkumar, Nandini R, Shweta A Mannikeri, Kailash Chandra, Umesh Naik and Pranesh	
1006	Effect of Foliar Application of Borex Levels on Growth, Yield and Quality of pomegranate (<i>Punica Granatum</i> L.)	523
	OM Prakash Jitarwa ¹ , Satpal Baloda ² , Keshar Mal Choudhary ³ and sushil ⁴	
1007	Impact of different sources of fertilizers on yield and quality parameters of Kinnow mandarin	523
	Monika Yadav, G.S. Rana, R.P.S Dalal, Vijay and Sonu Kumari	
1008	Breeding technology changes the landscape of ruminant industry	523
	R.I.A. Raja Khalif	
1009	Molecular Genetic Analysis for YMV Resistance in Blackgram (<i>Vigna mungo</i> L. Hepper)	524
	K. R. SARAVANAN*, P. KARTHIKEYAN, S. VENNILA, and S. SUGANTHI	
1010	Response of Manures and Inorganic Sources of Nutrient on Growth, Yield and Quality of Chickpea (<i>Cicer arietinum</i> L.)	524
	V.K Singh, Ankur Sharma and Shreya Bhatt	
1012	Impact of Vermicompost based Integrated Nutrient Management on Productivity Enhancement of Broccoli and Soil Properties under Hill Agro-ecosystem of North East India	525
	Popiha Bordoloi	
1013	Evaluation of Potential Biocontrol Bacterial Strains against <i>Verticillium</i> Wilt of Cotton	525
	Kamaldeep Kaur, Ashish Vyas	
1014	Agronomic performance of Lentil under the various weed management strategies	525
	Priyanka Bankoti, Mansi Nautiyal*	
1015	Plant Growth Promoting Rhizobacteria (Pgpr), Its Importance and Future Perspectives In Agriculture	526
	Shalini Kotiyal and Manjusha Tyagi	
1016	Performance of wheat (<i>Triticum aestivum</i>) varieties under cold stress condition	526
	Girish Chandra* ¹ , Radha Upadhyay ² , Kamla Dhyani ³ and Sobha Bisht ¹	

3rd International Conference on “Global Initiative in Agricultural, Forestry and Applied Sciences for Food Security, Environmental Safety and Sustainable Development (GIAFAS-2021)”

1017	Ways to encourage participation of farmwomen in family welfare and agricultural development Nidhi B. Thakur ¹ and J. B. Patel ²	527
1018	Seed Vigour Tests on Different Cultivars of <i>Phaseolus Vulgaris</i> Grown In Chamoli District of Uttarakhand, India *Sobha and J.S. Chauhan and Kamla Dhayani	527
1019	Open heap compost system: A promising traditional practice for sustainability of Hill-agro-ecosystem in Indian Himalaya's *Akshat Uniyal ¹ , Krishna K Singh ² and N S Bisht ³	528
1020	Applications of biodegradable polymers in food packaging industry Mohammad Amir ^{1#} , Roohi ¹ , Mohammed Kuddus ^{2*#}	528
1021	Bioinformatics analysis of miRNA and mRNA expression profiles to reveal the key miRNAs and genes in small cell lung cancer Imteyaz Ahmad Khan ¹ , Dr. Raziuddin Khan ² , Dr. Imteyaz Ahmad ³ , Dr. Mohammad Ahmad Ansari ⁴ , Dr. Srikant Sharma ^{1*}	529
1022	Climate change and global warming: impacts and management Mangi Lal Jat, Madan Nath & Yeragorla Venkata Harikrishna	529
1023	Deciphering the Puzzle of Hypobaric Hypoxia: Proteomics, Prophylaxis and Modelling Approach Yasmin Ahmad	530
1024	Chilli anthracnose: Spread and its Management Sushilkumar. S ¹ , Muthu kumar. R ² , Bhuvanewari.V ³ , Jarman gadi ¹ , Shivani Kumari ¹ .	530
1025	Innovative approach of Agri-business Management in creating opportunities Smriti Yadav ¹ , PratisthaYadav ²	531
1026	Agriculture drone technology: revolutionize agriculture management helps farmers in normal condition as well as in crises Pratistha Yadav ¹ , Smriti Yadav ²	531
1027	Pros and cons of biotechnology in agriculture and food security Mohammed Kuddus	532
1028	Interventional study to improve the haemoglobin level using green leafy multigrain flour on anaemic women in Neemuch district (M.P) Shilpi Verma, P.S.Naruka, S.S.Sarangdevot, C.P.Pachauri and J.P Singh	532
1029	Achievements in Quality Improvement in Temperate Fruit crops through Molecular Approaches Ikra Manzoor ¹ ,K.M.Bhat ¹ ,A.R.Malik ¹ and Usma Jan ²	532
1030	Innovative Partnership Framework for Rice Sector Arun Kumar S	533
1031	Effect of Different Poplar (<i>Populus deltoides</i> Bartr.) Clones after eleven years of Plantation in Calciorthents of Bihar. ¹ Atul Kumar, ¹ Shriman Kumar Patel, ² Vijay Kumar, ³ Jeetendra Kumar, ³ Ajit Kumar and ³ Wajid Hasan	533
1032	Application of geo-spatial study for assessment of soil quality index for tea growing soils in Kishanganj district, Bihar Mamta Kumari, Rajkishore Kumar, B.K. Vimal, Y. K. Singh and Atul Kumar	534
1033	Influence of abiotic factors on growth and development of vegetable crops Rahul Kumar Gupta and Ajay Bhardwaj	535
1034	Identification and Documentation of Indigenous Technical Knowledge practiced in agriculture and horticulture in Nalgonda District, Telangana Pallavi, S. ^{*1} , M.A. Aariff Khan ¹ , M. Shankar ¹ , T. Bharath ¹ , T. Himabindu ¹ and M. Shankaraiah ¹	535

3rd International Conference on “Global Initiative in Agricultural, Forestry and Applied Sciences for Food Security, Environmental Safety and Sustainable Development (GIAFAS-2021)”

1035	Plant diseases identification through computer technologies in tomato crop Angelina Gill ¹ and Yendrembam K Devi ²	536
1036	Induced Systemic Resistance in Chilli against <i>Colletotrichum capsici</i> : A Review Adesh Kumar*, Adarsh Sharma, Tammana Rana and Shuja Ahmaed	536
1037	Production of Fruit Powders and Formulation of Instant Probiotic Fruit Powder Mix S Mounika, M Saipranavi, Dr. R. Swamy and Dr. J. Sai Prasad*	537
1038	Farmer Producer Organization- A Way Towards Success Swarnima Paliwal*, R.S. Jadoun and Arunima Paliwal ¹	537
1039	Effect of Plant Spacing and Training on Fruit Quality of Capsicum (<i>Capsicum annuum</i> L) under Protected conditions. Ghanshyam Thakur* ¹ , Anil Kumar Singh ² , Pankaj Kumar Maurya ³	538
1040	Monitoring the effect of Deuteromycetes Fungi on host plants Aditi Maithani, Laxmi Rawat	538
1041	Current scenario of Step Farming in Hilly Areas of Uttarakhand Gosiya Ayub, Moinuddin and Ankit Semwal	539
1042	Effects of bioaccumulation of copper on growth and biochemical constituents of the seedlings of <i>Casuarina equisetifolia</i> L.(CASUARINACEAE) Rathna Kumari, B.M ¹ and Raveesha, H.R ² ;	539
1043	Mechanization in rice cultivation and advanced technology implemented V. KALIRAJAN	539
1044	Morphological characters of French marigold (<i>Tagetes patula</i> L.) genotypes Priya Bhusaraddi, V.V. Bhagat and B. S. Kulkarni	540
1045	Effect of spacing and leaf cuttings on leaf and seed yield of spinach (<i>Beta vulgaris</i> L.) var. All green V. V. Bhagat, Saba sheikh Najeer and A. S. Lohakare	540
1046	A Review on Significance of Pollination Services Ranjeet Kumar, Himani Saini and Sangeeta Verma	541
1047	Current Scenario and its Future Prospectus of Aquaponics Moinuddin, Aishwarya Petwal and Ankit Semwal	541
1048	Nutritional Benefits of Hibiscus Plant Deepak Som, Moinuddin, Deepti Yadav, Ankit Semwal and Aditya Mittal	542
1049	Impact of Global Warming on Crop Production Wasim Khan, Moinuddin*, M. Sekhar**, B. Rahul***, and Siddhant Gupta**	542
1051	Indigenous Technical Knowledge (ITK) for Sustainable Development in Agriculture M. Sekhar, M. Madhu* Moinuddin** and B .Rahul***	542
1052	Selection of phenotypically superior trees of Jujube (<i>Ziziphus jujuba</i> Mill.) as an agroforestry tree species under stress conditions M. Maqbool Rather, Firdous A. Sheikh, P. A. Khan and *Manzoor A. Dar	543
1053	Influence of Chemical Fertilizers on Growth, Yield and Nutrient Content of Mungbean (<i>Vigna radiata</i> L.) Siddhant Gupta*, Moinuddin**, M. Sekhar** and Meenakshi Joshi***	543
1054	Basic Reasons for Poor Nutritional and Health Status of Children Nandana Kumari* and Prof. Rita Singh Raghuvanshi**	544
1055	Genetic variability parameters for traits related to shoot fly tolerance in colored pericarp sorghum (<i>Sorghum bicolor</i> (L.) Moench) S.S. Deshmukh, R.R. Dhutmal and A.W. More	544
1056	Genetic diversity for grain yield and it's attributing traits in coloured pericarp sorghum (<i>Sorghum bicolor</i> (L.) Moench) S.S. Deshmukh, R.R. Dhutmal and A.W. More	545
1057	Character association studies for grain yield and it's attributing traits in coloured pericarp sorghum (<i>Sorghum bicolor</i> (L.) Moench)	545

3rd International Conference on “Global Initiative in Agricultural, Forestry and Applied Sciences for Food Security, Environmental Safety and Sustainable Development (GIAFAS-2021)”

R.R. Dhutmal, S.S. Deshmukh and H.V. Kalpande

1058	Genetic diversity for traits related to shootfly tolerance in coloured pericarp sorghum (<i>Sorghum bicolor</i> (L.) Moench) R.R. Dhutmal, S.S. Deshmukh and A.W. More	545
1059	Effect of Integrated Nutrient Management on Growth and Yield of Pomegranate (<i>Punica granatum</i> L.) Bhagyaresha R. Gajbhiye*, V. D. Patil and Tejswini R. Kachave	546
1060	Effect of Integrated Nutrient Management (INM) on Available Micro Nutrients of Pomegranate (<i>Punica granatum</i> L.) Orchard Soil Bhagyaresha R. Gajbhiye*, V. D. Patil and Tejswini R. Kachave	546
1061	Studies on performance of different varieties of banana under marathwada region S.V.Dhutraj ¹ and R.V.Deshmukh ²	547
1062	Field evaluation of soil application of biofertilizer for intensity of sigatoka leaf spot and yield of banana S.V.Dhutraj ¹ and R.V.Deshmukh ²	547
1063	Effect of different organic fertilizer on growth, yield and quality of brinjal (<i>solanum melongena</i> L.) cv. Manjari gota Ingle, V.V. Bhagat and A. K. Gore	547
1064	Morphological characters of French marigold (<i>Tagetes patula</i> L.) genotypes Priya Bhusaraddi, V.V. Bhagat and B. S. Kulkarni	548
1065	Screening of chickpea genotype for resistance against wilt (<i>Fusarium oxysporum</i> f.sp. <i>ciceri</i>) Minakshi Patil and Om Gupta	548
1066	Effect of various mutagenic treatments against <i>Fusarium oxysporum</i> f. sp. <i>ciceri</i> , causing chickpea wilt M.G. Patil, V. G. Kasod, C.V. Ambadkar and K.T. Apet	549
1067	Qualitative study of <i>khoa</i> produced in major <i>khoa</i> producing areas of Marathwada region Kamble N.S.; Londhe G.K.; S. G. Narwade and B. M. Thombre	549
1068	Effect of spacing and leaf cuttings on leaf and seed yield of spinach (<i>Beta vulgaris</i> L.) var. All green V. V. Bhagat, Saba sheikh Najeer and A. S. Lohakare	550
1069	Effect of different seed rates and spacing on Growth, yield attributes and grain yield of rice D. C. Lokhande	550
1070	Influence of some micro-nutrients management practices on rice yield D. C. Lokhande	551
1071	Studies on Preparation of <i>Lassi</i> Blended with Biofortified Sorghum (<i>Parbhani Shakti</i>) Sawant V.Y.; Londhe G.K and Kamble N.S.	551
1072	Roasted soybean: As influenced by quality parameters and sensory evaluation of soy flour S.B. Jadhav and M.M.Nirva	552
1073	Evaluation soy flour samples prepared from different methods S.B. Jadhav and M.M.Nirval	553
1074	Expression of regucalcin, a calcium binding protein is regulated by Hypoxia inducible factor-1alpha Tripti Singh, Pallabi Banerjee, Anshuman Chandra, Nagendra Singh and Imteyaz Qamar	553
1075	Influence of different chemicals on yield and quality of mango (<i>Mangifera indica</i> L.) cv.Kesar A.S. Lohakare*, V.V. Bhagat and S. Ambrish	553
1076	COMPARATIVE EVALUATION OF INTERCROPPING OVER MONOCROPPING WITH REFERENCE TO RESOURCE USE EFFICIENCY AND MONETARY ADVANTAGE Barkha	554
1077	Effect of Fertility Levels of Nitrogen and Weed Management Practices on Growth and Yield of Wheat (<i>Triticum aestivum</i> L.) Saif Alam Khan, Sirazuddin, Roop Kishore Sharma and *Moinuddin	554
1078	Study the size of planting material (single node cutting) and spacing on growth and yield of turmeric Radhajogita Mondal ¹ andJ. K. Hore ²	554
1079	Assessment of Suitable Clones of Eucalyptus for Eastern Uttar Pradesh, India Anubha Srivastav, S. D. Shukla & Yogesh Kumar Agarwal	555
1080	Investigating the impact of diethyl sulphate in banana (<i>Musa paradisiaca</i>) cv. Grand Naine Rajni Rajan ¹ and M Feza Ahmad ²	555

3rd International Conference on “Global Initiative in Agricultural, Forestry and Applied Sciences for Food Security, Environmental Safety and Sustainable Development (GIAFAS-2021)”

1081	Precision Farming in Indian Agriculture Harish Kumar Bijarnia	555
1082	Small and Marginal Farmers in GPS, GIS and Precision Agriculture in India Shankar Lal Bijarnia and Harish kumar Bijarnia	556
1083	Impulsion of agriculture polytechnic students SHELKE R.A.* ¹ , GOHAD V.V. ² , NIRPAL R. S. ³	556
1084	Impact analysis of onion varieties in Maharashtra. R. S. NIRPAL ¹ , R.A. SHELKE ² , V.G.POKHARKAR ³ , S.R.RAUT	557
1085	Doubling Indian farmers' income: a challenge Bhartendu Yadav	557
1086	Recent trends and past perspectives in Hybrid Seed Production in Wheat Ankit Jaiswal ¹ and Yuvraj Yadav ^{2*}	558
1087	Selection of phenotypically superior trees of Jujube (<i>Ziziphus jujuba</i> Mill.) as an agroforestry tree species under stress conditions M. Maqbool Rather, Firdous A. sheikh, P. A. Khan and Manzoor A. Dar	558
1088	Effect of neem coated urea through different nitrogen application schedule on nutrient status of soil in rice (<i>Oryza sativa</i> L.) Shriman Kumar Patel ¹ , Yogesh Kumar ² , and Atul Kumar ³	559
1089	Role of Nanotechnology in Agriculture Abhishek kumar ¹ , Vibha kumari ² and Manish Kumar ³	559
1090	Bio-herbicides for weed control Manish Kumar ¹ , Abhishek Kumar ² and Gautam Pratap Singh ³	560
1091	Foliar nutrition of crops for better production and productivity Vibha Kumari ¹ and Abhishek Kumar ²	560
1092	Biofortification of Micronutrients in Pulses Abhinav Kumar ¹	561
1093	HAPLOTYPE BASED BREEDING – NOVEL METHOD TO DEVELOP TAILOR MADE RICE. Nitesh kushwaha	561
1094	Process Optimization for Manufacturing of 'Banana Enriched Ice Cream Saloni ¹ , Dinesh Chandra Rai ¹	562
1095	Correlation and path analysis of yield and its attributing traits in sugarcane Rajvinder Singh ¹ , D. N. Kamat ¹ , R. G. Zala ¹ , Pooja Kumari ¹ and Saipayan Ghosh ¹	562
1096	Impact of Combined Abiotic and Biotic Stresses on Plant Growth and Avenues for Crop Improvement Tushar Arun Mohanty ¹ , Poojashree Mahapatra ² , Digvijay Singh ³ & Nitesh Kushwaha ⁴	563
1097	Impact of Conservation Agriculture on soil Potassium dynamics under Maize based cropping system Gopal Kumar*, PriyankaKumari, ShailjaKumari, RaginiKumari, Amitpradhan, Rajiv Padbhushan	563
1098	Embryo rescue in wide hybridization Awnish Kumar ¹ , *Digvijay Singh ¹ , Jyoti Kumari ¹ , Chandan Kishore ¹ , Ravi Shankar Singh ¹	564
1099	Plant breeding and climate change Ruchika Chhaya, Sorabh Sethi, Pooja Kumari	565
1100	Bio fortification of zinc in fodder oat through foliar application Manish Kumar*	565
1101	Recent advances in Climate Smart Plant Breeding Surabhi Sinha ^{1*} , Zafar Imam ² , Digvijay Singh ² , Satyendra ²	566
1102	Effect of Different Poplar (<i>Populus deltoides</i> Bartr.) Clones after eleven years of Plantation in Calciorthents of Bihar. ¹ Atul Kumar, ¹ Shriman Kumar Patel, ² Vijay Kumar, ³ Jeetendra Kumar, ³ Ajit Kumar and ³ Wajid Hasan	566

3rd International Conference on “Global Initiative in Agricultural, Forestry and Applied Sciences for Food Security, Environmental Safety and Sustainable Development (GIAFAS-2021)”

1103	Application of geo-spatial study for assessment of soil quality index for tea growing soils in Kishanganj district, Bihar Mamta Kumari, Rajkishore Kumar, B.K. Vimal, Y. K. Singh and Atul Kumar	567
1104	Genomics Tools for Breeding Submergence Tolerance in Rice Digvijay Singh ^{*1} , Satyendra ¹ , Sweta Sinha ² and Mankesh Kumar ¹	568
1105	Influence of abiotic factors on growth and development of vegetable crops Rahul Kumar Gupta and Ajay Bhardwaj	568
1106	BREEDING FOR FUSARIUM WILT RESISTANCE IN BRINJAL (<i>Solanum melongena</i> L.) Prashant Patil and Dileepkumar Masuthi	569
1107	PEG induced screening of tomato parents and F ₁ 's for drought tolerance in early germination and seedling stage Karthik G U, Lakshmiddevamma T N* and Dileepkumar Masuthi	569
1108	PELLETING WITH MEDICAL PLANT EXTRACT ON INCREASE VIABILITY IN ANNUAL CHRYSANTHEMUM Dileepkumar Masuthi, Shivayogi R, Bapuraygouda Patil, Satish D and A. M. Nadaf	569
1109	Pre-Germination Treatments on viability in ridge gourd (<i>Luffa acutangla</i> L.). DILEEPKUMAR A M, SATISH D, A.M.NADAF AND G. S. PRAVEENAKUMAR .	570
1110	Antioxidant content of 62utria-dense composite mix Deeksha Naik ¹ and Uma Kulkarni ²	570

Determining the nutrients level norms for high yield apple orchards in two main regions of Iran

Majid Basirat^{1,*}, Akbar Gandomkar², Farokh Ghani Shayesteh³ and Seyed Majid Mousavi¹

¹*Soil and Water Research Institute, Agricultural Research, Education and Extension Organization (AREEO), Karaj, Iran*

²*Isfahan Agricultural and Natural Resources Research and Education Center, Agricultural Research Education and Extension Organization;*

³*West Azarbaijan Agricultural and Natural Resources Research and Education Center, Agricultural Research Education and Extension Organization*

ABSTRACT

In order to determine the nutrient level norms for apple orchards of Isfahan (Semirom) and West Azerbaijan (Urmia) provinces, Iran, a research was conducted for two years. 40 orchards were selected in each region and 30 trees in each orchard were signed for measurements. In the first year, soil tests and plant analysis from the orchards were performed and 10 orchards were fertilized based on the results of soil and plant analysis. Then the average yield of the signed trees was recorded at the end of the season. The compositional nutrient diagnosis method was used for determining the high and low yielding groups of the orchards and the nutrients norms were calculated. The optimal yield of the apple orchards in Semirom region was 38.5 tons per hectare and the optimal concentration range of nutrients for nitrogen were 0.78%, $\pm 0.01\%$, potassium 2 ± 0.12 ; calcium $1.90 \pm 0.186\%$, phosphorus $0.24 \pm$ determined as follows: nitrogen 1.70 1.4 and boron ± 7 mg/kg, copper 6.71 ± 2 mg/kg, iron $188 \pm$ magnesium $0.38 \pm 0.07\%$, manganese 69 ± 3 mg/kg, zinc 1748 ± 18 mg/kg. The results showed that most of the orchards in Semirom region had deficiency of phosphorus and potassium. In contrary, P and K levels were higher in high yielding groups. Likely the calcisols of Semirom region which have about 40% calcium carbonate, is one of the important reasons for low mobility and uptake of phosphorus and micronutrients. The optimal yield of apples in the region of Urmia was 50 tons per hectare and the range of optimal concentrations of nutrients were as follows: nitrogen $1.52 \pm 0.14\%$, phosphorus $0.24 \pm 0.03\%$, potassium $1.94 \pm 0.22\%$, calcium $1.80 \pm 0.75\%$, magnesium $0.55 \pm 0.11\%$, manganese 33 ± 3 mg/kg, zinc 25 ± 0.3 mg/kg, iron 101 ± 8 mg/kg, copper 12 ± 1.4 mg/kg and boron 75 ± 2 mg/kg. Based on the results, low calcium and zinc and high concentrations of magnesium and boron are observed in the low-yield apple orchards of Urmia.

Keywords: Apple, Nutrients reference norms, Compositional nutrient diagnosis method

Biochar; A solution to increase nitrogen use efficiency in paddy soils

Meysam Cheraghi 1 , Sepideh Bagheri Novair 2

University College of Agriculture and Natural Resources, University of Tehran

Graduated PhD in department of soil science, University College of Agriculture and Natural Resources, University of Tehran

ABSTRACT

Nitrogen is one of the most important limiting nutrients for rice production in paddy fields. Lack of proper management of nitrogen, especially in paddy fields, has led to nitrogen wastage and, consequently, increased application of nitrogen fertilizers and therewith environmental pollution. Therefore, finding of the practical solutions for nitrogen management in paddy fields is important. It has been shown that the application of biochar in paddy fields by improving soil properties such as increasing cation exchange capacity and improving pH, leads to continued nitrogen availability and reduces the need for nitrogen fertilizers in paddy fields. Application of biochar also increases the level of environmental health by reducing nitrogen leaching and

preventing denitrification. Due to this important issue, the present study was conducted to investigate the potential of biochar on improving the nitrogen cycle and reducing nitrogen waste in paddy soils. The results of this study showed that; 1) The type of raw materials, pyrolysis temperature and application rate of biochar

are among the effective factors on increasing the efficiency of biochar. 2) The use of biochar in paddy soils reduces nitrogen wastage through leaching of nitrate (NO_3^-) and ammonium (NH_4^+), nitrous oxide (N_2O) emission and ammonia (NH_3) sublimation, and increases nitrogen use efficiency in paddy fields and helps to maintain environmental health. 3) The application of biochar acts as a slow release fertilizer by promoting nitrogen mineralization and releasing it due to the exchange process, and perpetuates nitrogen availability.

Keywords: Nitrogen use efficiency, Biochar, Paddy soil, Environment health

Importance and functions of biochar in soil and plant health

Meysam Cheraghi 1 , Seyed Majid Mousavi 2* , A. K. Srivastava 3

1 Department of Soil Science, University of Tehran, Karaj, Iran.

2 Soil and Water Research Institute; Agricultural Research, Education and Extension Organization (AREEO); Karaj; Iran

3 Indian Council of Agricultural Research- Central Citrus Research Institute, Nagpur, Maharashtra, India.

ABSTRACT

Increased population growth, the desire for industrialization, climate change, land use change and increased soil erosion have led to reduce in production capacity and the creation of important environmental issues. Recently, the use of biochar as a powerful modifier to maintain environmental health and increase soil fertility and production capacity has attracted the attention of many environmental and agricultural scientists; Because its application leads to a wide range of positive physical, chemical and biological interactions in the soil. Finally, it leads to increase in plant growth and yield in the soils that have low fertility level or are under adverse climatic and environmental conditions. Biochar is important for the physical, chemical and biological properties of soil due to its specific surface area, cation exchange capacity, nutrient content and high organic matter content. Therefore, in this study we will discuss these interactions. In addition, this article aims to investigate the factors affecting the performance of biochar and identify its strengths and weaknesses. An overview of the effects of biochar on improving of soil fertility and the environment; and provides valuable strategies to maximize its positive effects and minimize its adverse effects. The present study showed that the application of biochar with

unique mechanisms is able to improve soil quality and subsequently lead to maintain the environmental health, increase the soil fertility and fertilizers use efficiency and ultimately improve the growth and yield of plants.

Keywords: soil quality, environment, soil fertility, biochar

Comparison of statistical Data-mining techniques in estimating important points of soil water retention curve of Iran soils

Arash Tafteh 1* , Naser Davatgar 2 , Azadeh Sedaghat 3

Department of irrigation and soil physics, Soil and Water Research Institute, Agricultural Research Education and Extension Organization (AREEO), Karaj, Iran.

ABSTRACT

While numerous studies have been conducted to develop and evaluate pedotransfer functions (PTFs), there are still a few questions to be resolved. There is, for instance, a question relating to the optimal structure of

the relationship between basic soil properties and soil water retention characteristics (SWRC), which can be formulated by different regression methods. This study evaluated the performance of data-mining techniques including random forest (RF), artificial neural network (ANN) and support vector machine (SVM) models to estimate field capacity (FC) and permanent wilting point (PWP) using 1960 soil samples throughout Iran. The general performance of data-mining techniques based PTFs was quantified by Normalized Root Mean Square Error (NRMSE), Mean Bias Error (MBE), Root Mean Square Error (RMSE) and Index of agreement Wilmot (d). According to the results, Random Forest method performed better than other methods. Results of Random Forrest method in estimation of FC (gr gr⁻¹ (%)) moisture, RMSE, NRMSE, MBE and d values are 4.15, 0.16, -0.1 and 0.88, respectively; and in estimation of PWP (gr gr⁻¹ (%)), RMSE, NRMSE, MBE and d values are 2.46, 0.18, -0.24 and 0.9, respectively. Both estimates of the MBE were negative, so there was no problem overestimation. According to the results, RF method performed better for high volume samples than other methods. In spite of the large sampling area and large sample size, the results of this study were acceptable. Our results indicate that data mining approaches are superior to traditional ones when modelling soil and water systems. It was found that, due to the limited input parameters, the accuracy of the model was reduced significantly. These findings provide a scientific basis for further investigation of the RF method.

Keywords: Data-mining, Field Capacity, Permanent Wilting Point, Soil water retention curve.

Response of sesame plants to different amounts of nitrogen and timing of application in main regions of Iran

Fereydun Nourgholipour 1* , Seyed Majid Musavi 1 , Arash Sabbah 2 , Majid Rajaii 3 , Mohammad Reza Rafii 4 , Mokhtar Zolfi Bavariani 5

¹Soil and Water Research Institute, Agricultural Research Education and Extension Organization, Karaj, Iran

²Kerman Agricultural and Natural Resources Research and Education Center, Agricultural Research Education and Extension Organization;

³Fars Agricultural and Natural Resources Research and Education Center, Agricultural Research Education and Extension Organization; ⁴ Khuzestan Agricultural and Natural Resources Research and Education Center, Agricultural Research Education and Extension Organization; ⁵ Bushehr Agricultural and Natural Resources Research and Education Center, Agricultural Research Education and Extension Organization

ABSTRACT

Due to the importance of sesame plants as an oilseed crop and its compatibility in arid regions, attention to this crop is increasing. The aim of this research was to determine the effects of different amounts of nitrogen on the quantitative and qualitative properties of this crop. The experiment was conducted as factorial arrangement based on a completely randomized block design with three replications in two cropping years. The regions consisted of Behbahan, Darab, Jiroft and Bushehr regions. The first factor included five levels of nitrogen (0, 25, 50, 75 and 100 kg N / ha) from urea source and the second factor was the timing of nitrogen application which had two treatments. In the first treatment urea was used in two splits (before planting + before flowering). In the second treatment, it was used in three splits (before planting + before flowering + before capsulation) in equal amounts of rates. The project had 10 treatments with considering of two factors. In each treatment grain yield, oil percentage, 1000-seed weight and nitrogen percentage per grain were measured. Based on the results, in Jiroft, application of three-stage split of 150 kg of urea is recommended. In

Behbahan, the application of 50 kg urea in two split is recommended. In Darab, 150 kg of urea in two split is recommended. In Bushehr, the use of 50 kg of urea in three splits for yields of less than 2000 kg is recommended. In this area, if the yield be further than 2000 kg, the recommendation of nitrogen fertilizer will be different. Organic carbon of the studied soils (0.1, 0.38, 0.8 and 0.81% for Jiroft, Bushehr, Darab and Behbahan, respectively) is in relation to the recommended values of nitrogen fertilizer (138, 100-75, 50-75 and 25-75 kg N / ha, respectively). It is recommended to consider the organic carbon of the soils for nitrogen recommendation. In addition to organic carbon, soil texture is also one of the issues that should be considered by farmers. Application of more fertilizer and three-stage division for lighter texture soil (Bushehr and Jiroft) and less fertilizer with two-stage division in heavier texture soil (Behbahan and Darab) is recommended.

Key words: sesame, nitrogen, split application, concentration, regions, yield, oil

The effect of potassium and calcium foliar application on physico-chemical characteristics of ‘Thomson Navel’ sweet orange during cold storage

¹Tahereh Raiesi and ²Javad Fatahi Moghadam

Citrus and Subtropical Fruit Research Center, Horticultural Science Research Institute, Agricultural Research and Education Organization (AREO), Ramsar;

ABSTRACT

The objective of the present study was to evaluate the effect of foliar application of calcium (Ca) and potassium (K) on physicochemical characteristics of ‘Thomson Navel’ orange trees (*Citrus sinensis* L. Osbeck.) also on the occurrence of stem end rind breakdown (SERB) disorder during cold storage compared to the control (spray with water). Thus, A two-year field experiment was conducted using a randomized block design with four types of foliar spray (including calcium ($\text{Ca}(\text{NO}_3)_2$), potassium (KNO_3), calcium+potassium ($\text{Ca}(\text{NO}_3)_2+\text{KNO}_3$) and control) in three replicates. The fruits were harvested approximately mid-December then stored at 5 ° C and 85% RH for three months. Sampling was performed every month and physicochemical characteristics were measured. The results showed that higher total soluble solids (TSS) and total acidity (TA) was achieved in the foliar application of potassium. However, with calcium foliar application (Ca and K+Ca), TSS and TA significantly decreased compared to the control and potassium foliar application alone, but the ratio between the two indices increased. Furthermore, the highest amount of vitamin C was found in the foliar application of potassium, while foliar application of calcium led to a decrease in vitamin C. Additionally, the results showed that the lowest weight loss was achieved in foliar application of calcium. Also, the results showed that the peel thickness of the fruit increased with foliar application (regardless of the type of mineral element) and the highest increase was found in foliar spray of K and K+Ca. The order of treatments was in terms of the percentage of SERB and the severity of SERB of the fruit was: control>potassium spray> calcium spray>potassium+calcium spray. In conclusion, foliar application of potassium and calcium can be used effectively to improve the fruit quality of the ‘Thomson Navel’ sweet orange. Also, calcium foliar application can reduce the incidence of SERB during cold storage.

Keywords: acidity, peel thickness, TSS, SERB,

Concept, formation and role of rhizosheath in increasing plant tolerance to water deficit stress and nutrient deficiency

Meysam Cheraghi^{1*}, Seyed Majid Mousavi² and Babak Motesharezadeh²

^{1,3} Department of Soil Science, University of Tehran, Karaj, Iran

²Soil and Water Research Institute; Agricultural Research, Education and Extension Organization (AREEO); Karaj; Iran.

ABSTRACT

One of the great challenges that agricultural communities are constantly facing is the existence of various abiotic and biotic stresses and their increasing expansion. Therefore, to achieve sustainable agriculture in the future and strengthen production capacity even under stress, it is necessary to acquire intelligent techniques to deal with these stresses. Techniques that despite high efficiency; they do not need expensive equipment and treatments. One of these techniques that has received less attention, despite the advice of previous researchers, is rhizosheath formation and its potential in controlling the environmental stresses. Rhizosheath is a layer of soil particles that mixes with mucilage and other microbial and plant secretions and in a dry and wet cycle in the soil, forms a pod with relatively high strength around the roots. Rhizosheath is effective in reducing the effects of water deficit stress and nutrient deficiency because it leads to continued contact of soil particles with the roots, which is essential for the absorption of water and nutrients under these conditions. Therefore, a study was conducted to investigate the various aspects affecting the formation of rhizomes and its effect on increasing plant tolerance to drought stress and facilitating nutrient uptake. The results of this study showed that; 1. Rhizosheath is a part of the rhizosphere that is structurally different from it. 2. The formation of rhizosheath and its thickness is influenced by various factors such as the presence of root hairs, mucilage and dry and wet rotation 3. The formation of rhizosheath helps to more tolerance of environmental stresses especially drought and better absorption of nutrients, especially phosphorus, nitrogen and zinc. According to the study and experience gained from it, it is recommended that researchers need to more focus on controllable aspects of plants (such as genetic traits) that improve rhizosheath production and strength.

Keywords: Rhizosheath, abiotic stress, Nutrient uptake, Sustainable agriculture, Rhizosphere

Estimating important points of soil water retention curve with experimental-physical models

Arash Tafteh^{1*}, Naser Davatgar², Azadeh Sedaghat³

Department of irrigation and soil physics, Soil and Water Research Institute, Agricultural Research Education and Extension Organization (AREEO), Karaj, Iran.

ABSTRACT

Attempts have been made to develop pedotransfer functions (PTFs) to estimate soil hydraulic properties from more easily-available soil data, such as texture, organic matter, bulk density. Among the modeling techniques to characterize soil structure, those using fractal theory are in majority. This study aims to obtain the two important points of soil

moisture curve (field capacity (FC) and permanent wilting point (PWP)) using traditional methods (first-order transfer functions, experimental-physical models. This study obtain FC and PWP moisture using by Saxton and Rawls (2006a) and Tyler and Wheatcraft (1990) models. In this study, 1960 soil samples have been taken from all over Iran. The results showed that the physical-experimental model of Tyler and Wheatcraft (1990) at low suction (FC) and at high suction (PWP) provide more accurate estimates of soil moisture than Saxton and Rawls (2006a). In estimation of FC (gr gr^{-1} (%)) moisture with Tyler and Wheatcraft (1990) models, RMSE, NRMSE, MBE and d values are 3.32, 0.13, -0.59 and 0.96, respectively. And in estimation of PWP (gr gr^{-1} (%)) moisture with Tyler and Wheatcraft (1990) models, RMSE, NRMSE, MBE and d values are 4.7, 0.35, 1.59 and 0.72, respectively. In this research, the best results have been shown by estimating field capacity moisture with the Tyler and Wheatcraft (1990) models. This is probably due to the nature of the fractal model and the close relationship between fractal dimension and moisture in low suction. In spite of the large sampling area and large sample size, the results of this study were acceptable. The results displayed the successful estimation of the soil moisture, applying a combination of soil physical and chemical attributes. We suggest that the soil parameters used in this research be used as baselines and as estimator of the hydrologic properties.

Keywords: Fractal model, experimental-physical models, Soil water retention curve.

Estimating the soil surface moisture by using spectral indices of Sentinel-2 satellite and Machine learning

Azadeh Sedaghat^{1*}, Mahmoud Shabanpour Shahrestani¹, Ali Akbar Nourouzi², Alireza Fallah Nosratabad³ and Hossein Bayat⁴

Department of Soil Science, Faculty of Agriculture, University of Guilan, Rasht, Iran

Soil Conservation and Watershed Management Research Institute (SCWMRI), AREEO, Tehran, Iran

Soil and Water Research Institute, Agricultural Research, Education and Extension Organization, Karaj, Iran

Department of Soil Science, Faculty of Agriculture, Bu-Ali Sina University, Hamedan, Iran

ABSTRACT

Soil moisture is an integral quantity parameter in hydrology and agriculture practices. Satellite remote sensing has been widely applied to estimate surface soil moisture. However, it is still a challenge to retrieve surface soil moisture (SM) data in the heterogeneous catchment at high spatial resolution. In order to predict the soil surface moisture, 5 pedotransfer functions (PTF₁₋₅) were developed by combining of basic soil properties (clay, silt/sand, and bulk density) and water spectral indices of Sentinel-2 satellite for 124 soil samples from Tehran, Semnan and Lorestan provinces, Iran. In this work, modelling of SM was done by Random Forrest (RF) and Multiple Linear Regression (MLR) methods. Based on the results, the accuracy of the RF based PTF_s was considerably more than the MLR-based PTF_s. Soil moisture was better estimated by using water spectral indices (such as, SWCI and NWDI indices), along with the soil texture fractions and bulk density as predictors in PTF₄. The RMSE decreased from 0.039 and 0.051 ($\text{cm}^3 \text{cm}^{-3}$) in PTF₁ to 0.031 and 0.03 in PTF₄ in the training and testing steps, respectively. The mean values of the RMSE, AIC, R² and MBE of the RF method were 0.031 $\text{cm}^3 \text{cm}^{-3}$, -548, 0.85 and 0.001, and 0.03 ($\text{cm}^3 \text{cm}^{-3}$), -297, 0.82 and -0.004 for the training and testing steps of all PTF_s, respectively, while these criterions for the MLR method were respectively 0.032 ($\text{cm}^3 \text{cm}^{-3}$), -542, 0.69 and 0.0003, and 0.043 ($\text{cm}^3 \text{cm}^{-3}$), -269, 0.63 and 0.002 for the training and testing steps. Since the MBE values were low, it was possible to disregard overestimation of the results. Estimations showed an acceptable correlation with the measured SM. Soil moisture significantly improved by using both methods, but the RF method was superior than the MLR method in the testing cases. In the testing step, the accuracy of the RF method was greater than that of the MLR method in 82% of the pedotransfer functions (PTFs) in terms of the AIC criterion. These results indicate the potential of spectral

indices to improve the performance of PTF in estimating SM. Thus, it is suggested to use readily available soil properties with spectral indices to predict the SM.

Keywords: Soil moisture; Sentinel-2; Spectral indices; Random forest.

Transcriptomic Analysis Uncovers the Change in Sucrose Metabolism of Fruits in Late-Ripening Sweet Oranges after Foliar Application of EE-GRSP

Hui-Hui Wu¹, A.K. Srivastava², Yan Li³, Ying-Ning Zou¹, and Qiang-Sheng Wu¹*

¹ College of Horticulture and Gardening, Yangtze University, Jingzhou, Hubei 434025, China;

² ICAR-Central Citrus Research Institute, Nagpur, Maharashtra, India;

³ Xingshan County Special Products Bureau, Xingshan, Hubei 443711, China;

ABSTRACT

Glomalin as a secondary metabolite of arbuscular mycorrhizal fungi has many functions on the plant and the soil, while the role of foliar spray of easily extractable glomalin-related soil proteins (EE-GRSP) in sucrose metabolism of citrus fruits is unknown. The present study use referenced transcriptome sequencing to uncover the mechanisms responsible for role of exogenous EE-GRSP regulating the sucrose metabolism of two late-ripening varieties of sweet oranges including Lane Late Navel and Rohde Red Valencia. The mapping proportion of sequencing reads was around 93%, much higher than 70% standard. A many 1804 and 1861 differentially expressed genes were identified on fruits of Lane Late Navel and Rohde Red Valencia, respectively, following the foliar spray of EE-GRSP. The GO enrichment analysis further showed differentially expressed genes were classified mainly to molecular function and biological process in Lane Late Navel and Rohde Red Valencia, respectively. Photosynthesis ranked second in KEGG metabolism in Lane Late Navel variety, and carbon fixation in photosynthetic organizations ranked first in KEGG metabolism in Rohde Red Valencia variety. The 70 (32 up-regulated and 38 down-regulated) differentially expressed genes were involved in sugar transporter on chromosomes. The response of foliar spray of EE-GRSP affected the fruit starch and sucrose metabolism of KEGG, with 15 (10 up-regulated and 5 down regulated) and 13 (2 up-regulated and 11 down regulated) differentially expressed genes identified in the Lane Late Navel and Rohde Red Valencia variety, respectively. Sucrose phosphate synthase (*cs5g19060*) was activated and reduced by foliar spray of EE-GRSP on Rohde Red Valencia and, respectively. *Cs1g18220* (an acid invertase) and *β-fructofuranosidase* genes were up-regulated and down-regulated in Rohde Red Valencia, respectively. These results established the involvement in molecular signaling in response to foliar spray of EE-GRSP activating fruit sugar metabolism, depending on varieties.

Acknowledgement: This work was supported by the 2020 Joint Projects between Chinese and CEECs' Universities (202019), and the Hubei Agricultural Science and Technology Innovation Action Project (Hubei Nongfa [2018] No. 1).

Effects of field inoculation with arbuscular mycorrhizal fungi on fruit quality and root physiological activity of citrus

Ming-Ao Cao¹, A.K. Srivastava², Ying-Ning Zou¹, and Qiang-Sheng Wu¹*

¹ College of Horticulture and Gardening, Yangtze University, Jingzhou, Hubei 434025, China

² ICAR-Central Citrus Research Institute, Nagpur, Maharashtra, India

ABSTRACT

Soil arbuscular mycorrhizal fungi (AMF) form a mutualistic symbiosis with plant roots and produce many benefits on plants under potted conditions, while it is not clear whether field inoculation with AMF has any benefits. The present study aimed to analyze the changes in mycorrhizal growth, fruit quality, and the content of mineral elements in roots and fruits of *Citrus reticulata* Blanco var. Ponkan mandarin cv. Jinshuigan grafted on *Poncirus trifoliata* L. after inoculated with mixed-AMF (*Diversispora versiformis*, *Funneliformis mosseae*, and *Rhizophagus intraradices*) and single *F. mosseae*. After the second year of AMF inoculations, root mycorrhizal colonization rate, root activity, soil hyphal length, and soil easily extractable glomalin-related soil protein content were significantly increased, while soil difficultly extractable glomalin-related soil protein content was decreased. Inoculation treatments also improved fruit quality regarding polar diameter, equatorial diameter, weight of single fruit, fruit peel, and sarcocarp, coloration value and soluble solid content, independent of AMF inoculations. In addition, *F. mosseae*-inoculated trees showed significantly higher P and Fe content of sarcocarps and P, K, Zn, and Mn content of roots, and mixed-AMF-inoculated trees represented higher P, Mn, Fe, and B content of sarcocarps and P, K, Mg, Zn, and Mn content, compared with non-

3rd International Conference on “Global Initiative in Agricultural, Forestry and Applied Sciences for Food Security, Environmental Safety and Sustainable Development (GIAFAS-2021)”

AMF-inoculated trees. Our study, therefore, suggested that field inoculation with AMF improved root physiological activities to some extent in terms of mycorrhizal growth and nutrient acquisition, and also improved fruit quality, with the effect of mixed-AMF being more significant than that of *F. mosseae* alone.

Acknowledgement: This work was supported by the Hubei Agricultural Science and Technology Innovation Action Project (Hubei Nongfa [2018] No. 1).

Status of Litchi in Bangladesh: Production, Marketing and Postharvest Loss Assessment

Sayla Khandoker¹, M. A. Rashid¹, M. Khatun¹ and M. S. Hoq¹

Bangladesh Agricultural Research Institute (BARI), Gazipur, Bangladesh

ABSTRACT

Litchi occupies an important place in the fruit platter of Bangladeshi people. Litchi cultivation provides both on-farm and off-farm employment, making it a reliable source of income for a large population in litchi-growing areas. It is a highly perishable fruit with very short harvest span. Several studies have been conducted on production, growth and disease and pest infestation of litchi. But studies related to details of litchi cultivation especially profitability and supply chain is scanty. Keeping this in mind, the study was undertaken to analyse the profitability, supply chain and post-harvest loss assessment of litchi in Bangladesh. The study was conducted in four major litchi growing areas namely Dinajpur, Pabna, Narayanganj and Khagrachhari districts. A total of 160 farmers and 124 traders were selected randomly for the study. Per hectare average cost of litchi cultivation was Tk. 1, 47,746. Per hectare average yield was 5.0 ton. Per hectare net return from litchi was Tk. 2, 03, 583. Litchi cultivation was found to be a profitable enterprise in the study areas since the (BCR 2.38), net present value (Tk. 16, 49,648) and internal rate of return (43%) was very high. Five major marketing chains were identified. Marketing costs and marketing margin of Bepari were highest among the intermediaries. The average postharvest losses were estimated to be 11.48% and 9.81% at the farmers' and traders level, respectively. Total production and distance to the market were positively significant whereas sale price, transportation dummy and packaging dummy were negatively significant to postharvest losses at farm level. Disease and insect infestation, damage of litchi due to sunburn and storm, attack of bird and bat were the major production problems for litchi. However, lack of efficient transport and higher cost of transportation were the major marketing problems. Area expansion under high yielding variety, shifting of area for litchi cultivation and establishing of agro processing industry were the major opportunities for litchi cultivation in Bangladesh.

Breeding innovation for vegetable and forage maize research in Vietnam: The Progress and Future perspective

Nguyen Trung Duc^{1*}, Pham Quang Tuan¹, Nguyen Thi Nguyet Anh¹, Vu Van Liet¹, Nguyen Xuan Thang²

¹*Vietnam National University of Agriculture, 100000, Hanoi, Vietnam*

²*Maize Research Institute of Vietnam, 100000, Hanoi, Vietnam*

ABSTRACT

Maize is the main cereal crop, plays a vital role as food, contributing to poverty reduction, ensuring food security in Vietnam, and also is a feed crop with high nutritional value. Plant breeding innovation plays a vital role in improving and sustainably maize production to feed 10 billion people by 2050. Novel alleles

located in diverse maize germplasm are excellent resources for breeding new high-yielding, better quality, and sustainable crop varieties to tackling future food security. Recent advances in maize genome sequencing and trait mapping have recognized many beneficial alleles for the breeding programs. Genome editing technologies are considered as innovative solutions to engineer complex traits such as yield, nutrient use efficiency, biotic, and abiotic stress resistance. In recent years, high-throughput phenotyping is rapidly developed in maize research, provided accurate, precise, and large-scale measurements of phenotypic traits, which is fundamental for association trait mapping and genomics selection. Speed breeding protocols remain critical to accelerating breeding cycle when integrated with genomic breeding strategy. In this review, we highlight the importance of maize genetic resources and develop new strategies for sustainable exploitation of maize genetic resources; provide an overview of the current status, research, and development status, and position of maize varieties for food and forage in Vietnam compared to the world; and determining a strategy for research and development of maize varieties for food and forage for the period 2021-2030, with a vision to 2045 to ensure sustainable agricultural development and resilience to climate change.

Key words: *Breeding, Innovation, Vegetable Maize, Forage Maize, Vietnam*

Status, opportunities and genetic improvement of minor cereals in Bangladesh

Zahirul A. Talukder*¹, A.N.M.S. Karim¹, M.M. Rohman¹, M.M. Billah¹, S.S. Alam¹, S.H. Omy¹, A.H. Akhi¹, M.K. Alam¹ and M.M. Ali¹

¹*Bangladesh Agricultural Research Institute (BARI), Bangladesh*

ABSTRACT

Bangladesh is one of the most vulnerable countries to climate change, which cause biotic and abiotic stresses. Abiotic stresses, especially drought, heat, waterlogging and salinity, affects crop yield to a great extent. Minor cereals, a group of neglected crops, play an important role in proving substitute of rice or wheat in the harsh environment of the globe. They are excellent source of carbohydrates, protein, vitamins and minerals, such as iron, magnesium, copper, phosphorus and zinc. Different minor cereals including foxtail millet (*Setaria italica* L.), sorghum (*Sorghum bicolor* L.) oat (*Avena sativa* L.), barley (*Hordeum vulgare* L.), finger millet (*Eleusine coracana* L.), pearl millet (*Pennisetum glaucum* L.) and (Proso millet (*panicum miliaceum* L.) are cultivated throughout the country. With the advent of modern technologies, irrigation facilities, high yielding varieties these minor cereal crops have been cultivated in many areas. Bangladesh has released some suitable minor cereal crop varieties. Among these some varieties perform good in adverse environmental condition. There are different types of minor cereals germplasm in Bangladesh. Germplasm evaluations of each cereal species have focused mainly on abiotic stresses, nutritional quality, and resistance to their main diseases. Development and deployment of improved cereal crops varieties with tolerance to abiotic and biotic stresses, and improved nutritional quality, are crucial for building resilience and adaptive capacity of the farming communities in changing climates. Improved cereal crops can be developed through conventional plant breeding with new plant breeding technology and molecular breeding including genome assisted breeding and biotechnology. The requirements for environmental friendly crops and a more diverse food supply for humans and animals provide new opportunities to cultivate minor cereals in the adverse climatic conditions.

VERMIREMEDIATION: AN INNOVATIVE APPROACH FOR CLEANING UP THE CHEMICALLY POLLUTED SOILS

Sanjay-Swami, Thokchom Dorenchand Singh, Shubham Singh and Pritisha Patgiri

School of Natural Resource Management, College of Post Graduate Studies in Agricultural Sciences, Central Agricultural University, Umiam (Barapani)-793 103, Meghalaya, India

ABSTRACT

Heavy metals polluted soils pose a high risk to ecosystem health. Vermiremediation using chemical tolerant earthworm species is emerging as a low-cost and convenient technology for cleaning up the chemically contaminated/polluted soils. This approach includes directly using earthworms to contaminated soils, co-application of earthworms to contaminated soils with another organic material, application of contaminated media (soils) to earthworms as a part of feeding regime and/or indirect use of earthworms through its digested materials. Earthworms significantly contribute as soil conditioner to improve the physical, chemical as well as the biological properties of the soil. They swallow large amount of soil every day, grind them in their gizzard and digest them in their intestine with aid of enzymes. Only 5-10 percent of the chemically digested and ingested material is absorbed into the body and the rest is excreted out in the form of fine mucus coated granular aggregates called ‘vermicastings’ which are rich in NPK, micronutrients and beneficial soil microbes including the ‘nitrogen fixers’ and ‘mycorrhizal fungus’.

Keywords: *Heavy metals, polluted soils, vermiremediation, suitable species, mechanism, advantages.*

Excessive use of chemical fertilizers deteriorates the soil physical, chemical and biological properties and also contaminates the surrounding environment. Soils contaminated with heavy metals pose a high risk to ecosystem health because of the multiple toxic effects associated with these chemicals at very low concentrations (Sanjay-Swami *et al.*, 2021). Heavy metals are the stable metals or metalloids whose density is greater than 4.5 g/cm³, namely Pb, Cu, Ni, Cd, Zn, Hg, Cr etc. They are stable and cannot be degraded or destroyed, and therefore they tend to accumulate in soils and sediments. Release of heavy metals into soil is also toxic even these are at very low concentrations. And heavy metals are not only cytotoxic, but also carcinogenic and mutagenic in nature. There are several techniques to remove heavy metals such as chemical precipitation, oxidation, reduction, filtration, ion exchange, etc. (Lyngdoh and Sanjay-Swami, 2020) but most of these techniques became ineffective, when the concentration of heavy metals is less than 100 mg/l. At this stage we can use microorganisms and plants for the removal of contaminants (Sanjay-Swami and Lyngdoh, 2019). In bioremediation process we use microorganisms and their biodegradative capacity to remove contaminants (Lyngdoh and Sanjay-Swami, 2020).

Earthworms have been found to remove heavy metals, pesticides and lipophilic organic micropollutants like the polycyclic aromatic hydrocarbons (PAH) from the soil (Butt *et al.*, 2004). Vermiremediation using chemical tolerant earthworm species is emerging as a low-cost and convenient technology for cleaning up the chemically polluted/contaminated soils in the world (Sanjay-Swami, 2021). The term ‘vermiremediation’ is a combination of two Latin words: *vermis* meaning worm and *remedium* meaning to correct or remove an evil. Vermiremediation is an earthworm based bioremediation technology that makes use of use the earthworm’s life cycle i.e., feeding, burrowing, metabolism, secretion; or their

interaction with other abiotic and biotic factors to accumulate and extract, transform, or degrade contaminants in the soil environment. Vermiaccumulation and vermieuxtraction refer to the process in which earthworms take up and, subsequently, store the contaminants in their bodies and therefore reduce the amount of pollutants in soils. Vermiremediation is a self-promoted, self-regulated, self-improved, self-driven, self-powered, self-enhanced, low or no energy requiring zero-waste technology, easy to construct, operate and maintain. Any vermiculture technology involves about 100-1000 times higher ‘value addition’ than other biological technologies. Obtaining earthworms from vermiculture farms would be one-time cost in any vermiremediation technology as the earthworms multiply rapidly creating huge army of worms which further promote and enhance the process.

The earthworm assisted bioremediation (vermiremediation) approaches include direct application of earthworms to contaminated soils (Schaefer and Filser, 2007); co-application of earthworms to contaminated soils with another organic material, such as compost (Ceccanti *et al.*, 2006); application of contaminated media (soils) to earthworms as a part of feeding regime (Getliff *et al.*, 2002); indirect use of earthworms through its digested (composted) materials (vermicompost) (Sanjay-Swami, 2021). Vermicast is high in degrader microbes and thus high in catabolic activities. It contains 32 million bacterial counts per gram as compared to 6-9 million/gram in surrounding soils (Sanjay-Swami and Bazaya, 2010; Sanjay-Swami, 2017).

Earthworms Species Suitable for Soil Remediation

Certain species of earthworms such as *Eisenia fetida*, *Aporrectodea tuberculata*, *Lumbricus terrestris*, *Lumbricus rubellus*, *Dendrobaena rubida*, *Dendrobaena veneta*, *Eiseniella tetraedra*, *Allobophora chlorotica* and *Pheretima Spp.* have been found to remove heavy metals, pesticides and lipophilic organic micro-pollutants from the soil (Contreras-Ramos *et al.*, 2006). Keeping many advantages in view, the School of Natural Resource Management, College of Post Graduate Studies in Agricultural Sciences of Central Agricultural University has already started research on vermiremediation technology by utilizing native earthworm species coupling with phytoremediation to enhance the efficiency of reclamation of heavy metals in the coal mined polluted soils of Jaintia Hills of Meghalaya, India.



Fig. 1: Vermiremediation of heavy metals from coal mined polluted soil in Jaintia Hills of Meghalaya, India

Mechanism of Worm Action in Vermiremediation:

Within the soil environment, an earthworm’s sphere of influence is known as the ‘drilosphere system’. This incorporates the burrow systems, surface and belowground earthworm casts, internal earthworm gut and process, the earthworm surface in contact with the soil, and associated biological, chemical and physical interactions, in addition to the soil microorganisms (Brown and Doube, 2004).

Earthworms have both ‘abiotic’ and ‘biotic’ effects on contaminated soils in the remediation process. Abiotic effects are burrowing actions and the resulting burrows acts as inputs points and preferred pathways for water and particle movement, nutrient flow and aeration. This also results into mechanical breakdown of soil particles exposing greater surface areas for biotic action. During burrowing, worms ingest and digest large amount of contaminated soils. By digestion the size of the soil organic matter containing contaminants is reduced significantly thus exposing more surface area of contaminated soil for microbial action and remediation. The biotic effects are proliferation of degrader microbes (bacteria, fungi and actinomycetes) by the earthworms by their excretion in contaminated soil which includes urine, intestinal mucus, glucose and other nutrients. There are also direct biotic effects of earthworms in the form of ‘feeding behaviours’ upon contaminants fates in soil. Studies indicate that earthworms increase their oral intake of soil particles when driven by ‘hunger stress.’ There were total petroleum losses in contaminated soil where earthworms were not provided with any food.

The hydrophobic organic contaminants are taken up by the earthworms in two ways:

- (1) Passive diffusion from the soil solution through the worms’ outer membrane; and
- (2) Intestinal re-sorption of the compounds from the soil while it passes through the gut by digestion and then their degradation by enzymatic activity called ‘Cytochrome P 450’ system.

This enzymatic activity have been found to operate particularly in *Elsenia fetida* which survive the benzo(a)pyrene concentration of 1,008 mg/kg of soil. Earthworm uptake chemicals from the soil through passive ‘absorption’ of the dissolved fraction through the moist ‘body wall’ in the interstitial water and also by mouth and ‘intestinal uptake’ while the soil passes through the gut. The passive diffusion is driven by the difference between the pore water in soil and within the earthworm’s tissues. The accumulation increases when the concentration of PAHs in their surrounding soil water or in their food increases Earthworms may take PAHs up through absorption by the body surface and also by feeding and ingestion, since PAHs sorb to the soil organic detritus, which the worms feed on. Earthworms apparently possess a number of mechanisms for uptake, immobilization and excretion of heavy metals and other chemicals. Earthworms either biodegrade or bio-transform the chemical contaminants rendering them harmless.

Table 1: Earthworm actions in improvement of soil structure and properties

Burrowing/	Burrow	Soil ingestion,	Earthworm
-------------------	---------------	------------------------	------------------

3rd International Conference on “Global Initiative in Agricultural, Forestry and Applied Sciences for Food Security, Environmental Safety and Sustainable Development (GIAFAS-2021)”

movement → creation → digestion and excretion → vermicasts

Improved soil structure	Improved O ₂ and gas diffusion	Breakdown of soil particles	Fragmented soil particles and increased surface areas
Increased porosity		Release of organic residues, enzymes & plant growth hormones	Increased water holding capacity of soil
Improved aggregation	Improved moisture drainage and dispersal	Transport & dispersal of beneficial microorganisms, elimination of harmful microorganisms	Higher soil organic matter
Release of bioavailable plant nutrients			
Organic matter turnover	Improved nutrient movement	Higher organic matter turnover	Enhanced bioavailable NPK & micronutrients with increased C:N ratio
Improved fertility		Addition of high energy water soluble organic compounds	Improve soil pH
Beneficial microorganism promotion and dispersal	Beneficial microorganism promotion and dispersal	Beneficial microorganisms promotion & proliferation	Beneficial microorganism promotion & multiplication

Determination of changes in heavy metal concentration

Three rectangular containers with cover lid and clips on both sides of the edges measuring 20 x 9 x 12 cm were arranged. The containers were weighed with a digital sensitive weighing balance and were properly labeled using tape and a permanent marker. One kg of the contaminated soil was then weighed into each of the three containers, and were moistened with distilled water to the water holding capacity of the soil. After 3 days, cow dung was freshly collected and about 50 g each of the cow dung weighed was thoroughly mixed into the containers with contaminated soil. Immediately after the addition of additives, earthworms were sorted out of the holding containers, washed with clean water and ten earthworms were inoculated into the contaminated soil. A netting material cut into sizes was placed on top of each of the containers and the cover lid frame was placed on top of it to hold it firmly with the help of the clips on both sides of the containers. This is done to avoid possible escape of the earthworms and allow free flow of oxygen into the treatments. The setup was placed in a shady area and checked morning and evening on a daily basis. After 15, 30 and 45 days the samples were collected from each container and the heavy metal concentration were find out using IS-3025 methods.

Table 2: Changes in heavy metals concentration during vermiremediation

Heavy metal	Changes in heavy metal concentration (mg/kg)				% of reduction after 45 days	Limits (mg/kg)
	Initial	15 Days	30 Days	45 Days		
Arsenic	12	3	0	0	100	1-50
Cadmium	0.3	0.19	0.12	0.03	90	0.01-0.7
Chromium	109	77	46	14	87.15	1-1000
Lead	67	51	29	9	86.56	2-200
Mercury	0.07	0.04	0.01	0	100	0.01-0.3
Nickel	87	64	36	11	87.35	5-500
Zinc	110	87	54	27	75.45	10-300
Copper	24	19	15	3	87.5	2-100

The concentration of arsenic, cadmium, chromium, lead, mercury, nickel, zinc and copper were reduced as 76.92, 95.5, 81.2, 54.46, 63.3, 61.31, 82.07 and 85.18%, respectively.

Advantages of Vermiremediation Technology

There are several advantages in using earthworms for bioremediation of chemically contaminated soils. Earthworms improve total quality of soil in terms of physical, chemical and biological properties. They have been shown to both ‘retard the binding of chemical compounds with soil particles’ and also ‘increase

compound availability’ for microbial action while also enhancing the population of degrader microbes within the system.

Earthworms have the potential to be employed not only in the recovery of contaminated soils as a part of bioremediation strategy, but also in the subsequent improvement of that soil and the land as a whole, for other beneficial uses. Significantly, vermiremediation leads to total improvement in the quality of soil and land where the worms inhabit. Earthworms significantly contribute as soil conditioner to improve the physical, chemical as well as the biological properties of the soil and its nutritive value. They swallow large amount of soil every day, grind them in their gizzard and digest them in their intestine with aid of enzymes. Only 5-10 percent of the chemically digested and ingested material is absorbed into the body and the rest is excreted out in the form of fine mucus coated granular aggregates called ‘vermicastings’ which are rich in NPK, micronutrients and beneficial soil microbes including the ‘nitrogen fixers’ and ‘mycorrhizal fungus’. The organic matter in the soil undergoes ‘humification’ in the worm intestine in which the large organic particles are converted into a complex amorphous colloid containing ‘phenolic’ materials. About one-fourth of the organic matter is converted into humus. The colloidal humus acts as ‘slow release fertilizer’ in the soil. During the vermiremediation process of soil, the population of earthworms increases significantly benefiting the soil in several ways. A ‘wasteland’ is transformed into ‘wonderland’. Earthworms are in fact regarded as ‘biological indicator’ of good fertile soil. One acre of wasteland when transformed into fertile land may contain more than 50,000 worms of diverse species.

Conclusion

Through a combination of direct and indirect (worm vermicast) action, earthworm effects upon promotion of catabolically competent microorganisms, and through their biological, physical and chemical actions on soil, the earthworm assisted vermiremediation of contaminated soils has been shown to be suited to a wide range of organic and inorganic chemicals. With the passage of time, the remedial action of worms becomes greatly intensified. As the worms multiply at an enormous rate it can quickly achieve a huge arsenal for enhanced degradation of chemicals in much shorter time.

Vermiremediation may prove very cost-effective and environmentally sustainable way to treat polluted soils and sites contaminated with diverse chemicals in just few weeks to months. Moreover, this is an ‘in-situ’ treatment on site. Comparing the cost incurred in ex-situ mechanical treatment by excavation of contaminated soils and their transport to treatment sites or for safe disposal in secured landfills (as hazardous wastes), this technology is most economic. The greatest economic and environmental benefit is that the remediated soil is ‘recovered’ for ‘reuse’ i.e. the land becomes suitable for agriculture/horticulture.

References:

- Brown, G.B. and Doube, B.M. (2004). On earthworms assisted bioremediation. In: C.A. Edward (Ed.), *Earthworm Ecology* (2nd Ed.), CRC Press, Boca Raton, FL: 213-239.
- Butt, K.R., Lowe, C.N., Frederickson, J. and Moffat, A.J. (2004). The development of sustainable earthworm populations at Calvert landfill site, UK. *Journal of Land Degradation and Development*, 15: 27-36.

3rd International Conference on “Global Initiative in Agricultural, Forestry and Applied Sciences for Food Security, Environmental Safety and Sustainable Development (GIAFAS-2021)”

- Ceccanti, B., Masciandaro, G., Garcia, C. Macci, C. and Doni, S. (2006). Soil bioremediation: combination of earthworms and compost for the ecological remediation of a hydrocarbon polluted soil. *Journal of Water and Air Soil Pollution*, 177: 383-397.
- Contreras-Ramos, Silvia, M., Alvarez-Bernal, Dioselina and Dendooven, Luc (2006). *Eisenia fetida* increased removal of polycyclic aromatic hydrocarbons (PAHs) from soil. *Environmental Pollution*, 141: 396-401.
- Getliff, J., McEwan, G., Ross, S., Richards, R. and Norman, M. (2002). Drilling fluid design and the use of vermiculture for the remediation of drill cuttings. AADE Technology Conference on *Drilling Fluids and Waste Management*.
- Lyngdoh, E.A.S. and Sanjay-Swami (2018). Phytoremediation effect on heavy metal polluted soils of Jaintia Hills in North Eastern Hill Region. *International Journal of Current Microbiology and Applied Sciences*, 7 (11): 1734-1743. doi.org/10.20546/ijcmas.2018.711.199
- Lyngdoh, E.A.S. and Sanjay-Swami (2020). Potential screening of phytoremediating crops and performance of maize in phytoremediated coal mined acid soil with phosphorus application. *Journal of Environmental Biology*, 41 (6): 1788-1797. DOI: <http://doi.org/10.22438/jeb/41/6/SI-283>.
- Sanjay-Swami (2017). Composting technology for organic crop production. In: *Organic Crop Production: Principles and Practices, Vol. I: Principles and General Aspects*, (ed.) Jag Paul Sharma, Kalyani Publishers, Ludhiana, pp. 219-245. ISBN: 978-93-272-7466-0.
- Sanjay-Swami (2021). Vermiremediation of soil pollutants: An innovative approach for Converting ‘Wasteland’ into ‘Wonderland’. In: *Soil and Water Conservation Today*, 16 (2): 06-07. ISSN: 0975-4059.
- Sanjay-Swami and Bazaya, B.R. (2010). Vermicompost technology. In: *Quality Seed Production of Vegetable Crops: Technological Interventions*, ed. Sharma, J. P., Kalyani Publishers, Ludhiana, Punjab, pp. 344-356.
- Sanjay-Swami and Lyngdoh, E.A.S. (2019). Restoration of degraded land in coal mine areas of Jaintia Hills, Meghalaya through phytoremediation. *Soil and Water Conservation Bulletin*, No. 4, Indian Association of Soil and Water Conservationists, Dehradun, UK, pp. 17-24.
- Sanjay-Swami, Singh, S., Patgiri, P., Raj, V.A. and Singh, T.D. (2021). Ecological sustainability in agricultural production intensification: NER perspective. In: *Sustainable Agriculture: Recent Advances*, (eds.) Sanjay-Swami and Singh, S., Biotech Books, New Delhi, India. pp. 1-20. ISBN: 978-81-7622-493-2.
- Schaefer, M. and Filser, J. (2007). The influence of earthworms and organic additives on the biodegradation of oil contaminated soil. *Journal of Applied Soil Ecology*, 36: 53-62.

Sustainable Development and Environment of Biomass from Agriculture Residues

Abdeen Mustafa Omer

Energy Research Institute (ERI), Nottingham NG7 4EU, United Kingdom

ABSTRACT

This communication discusses a comprehensive review of biomass energy sources, environment and sustainable development. This includes all the biomass energy technologies, energy efficiency systems, energy conservation scenarios, energy savings and other mitigation measures necessary to reduce emissions globally. This study highlights the energy problem and their possible saving that can be achieved through the use of biomass energy sources. Also, this study clarifies the background of the study, highlights the potential

energy saving that could be achieved. The use of biomass energy source describes the objectives, approach and scope of the theme. However, to be truly competitive in an open market situation, higher value products are required. Results suggest that biomass technology must be encouraged, promoted, invested, implemented, and demonstrated as a whole while especially in remote rural areas.

Keywords: Biomass resources, wastes, woodfuel, biofuels, energy, environment

Introduction

There is strong scientific evidence that the average temperature of the earth’s surface is rising every year. This was a result of the increased concentration of carbon dioxide (CO₂), and other greenhouse gases (GHGs) in the atmosphere as released by burning fossil fuels [1-2]. This global warming will eventually lead to substantial changes in the world’s climate, which will, in turn, have a major impact on human life and the environment. Energy use can be achieved by minimising the energy demand, by rational energy use, by recovering heat and the use of more green energies. This will lead to fossil fuels emission reduction. This study was a step towards achieving this goal. The adoption of green or sustainable approaches to the way in which society is run is seen as an important strategy in finding a solution to the energy problem. The key factors of reducing and controlling CO₂, which is a major contributor to global warming, are the use of alternative approaches to energy generation and the exploration of how these alternatives are used today and may be used in the future as green energy sources. Even with modest assumptions about the availability of land, comprehensive fuel-wood farming programmes offer significant energy, economic and environmental benefits. These benefits would be dispersed in rural areas where they are greatly needed and can serve as linkages for further rural economic development. The nations as a whole would benefit from savings in foreign exchange, improved energy security, and socio-economic improvements. With a nine-fold increase in forest – plantation cover, the nation’s resource base would be greatly improved. The non-technical issues, which have recently gained attention, include:

- Environmental and ecological factors, e.g., carbon sequestration, reforestation and revegetation. .1
 - Renewables as a CO₂ neutral replacement for fossil fuels. .2
 - Greater recognition of the importance of renewable energy, particularly modern biomass energy carriers, at the .3
policy and planning levels.
 - Greater recognition of the difficulties of gathering good and reliable biomass energy data, and efforts to improve it. .4
 - Studies on the detrimental health efforts of biomass energy particularly from traditional energy users. .5
- There is a need for some further development to suit local conditions, to minimise spares holdings, to maximise interchangeability both of engine parts and of the engine application. Emphasis should be placed on full local manufacture [3]. Energy is an essential factor in development since it stimulates, and supports economic growth and development. Fossil fuels, especially oil and natural gas, are finite in extent, and should be regarded as depleting assets, and efforts are oriented to search for new sources of energy. The clamour all over the world for the need to conserve energy and the environment has intensified as traditional energy resources continue to dwindle whilst the environment becomes increasingly degraded. Alternatively energy sources can potentially help fulfill the acute energy demand and sustain economic growth in many regions of the world. Bioenergy is beginning to gain importance in the global fight to prevent climate change. The scope for exploiting organic waste as a source of energy is not limited to direct incineration or burning refuse-derived fuels. Biogas, biofuels and woody biomass are other forms of energy sources that can be derived from organic waste materials. These biomass energy sources have significant potential in the fight against climate change [4].

Conservation of energy and rationing in some form will however have to be practised by most countries, to reduce oil imports and redress balance of payments positions. Meanwhile development and application of nuclear power and some of the traditional solar, wind, biomass and water energy alternatives must be set in hand to supplement what remains of the fossil fuels. The encouragement of greater energy use is an essential component of development. In the short-term it requires mechanisms to enable the rapid increase in energy/capita, and in the long-term we should be working towards a way of life, which makes use of energy efficiency and without the impairment of the environment or of causing safety problems [5].

The objective of this article is to highlight problems related to biomass applications and suggest methods to overcome these problems. This will be achieved through a comprehensive literature review of biomass, their application and the related problems.

The current literature is reviewed regarding the ecological, social, cultural and economic impacts of biomass technology. This study gives an overview of present and future use of biomass as an industrial feedstock for production of fuels, chemicals and other materials

Materials and Methods

The aim of any modern biomass energy systems must be:

- To maximise yields with minimum inputs.
- Utilisation and selection of adequate plant materials and processes.
- Optimum use of land, water, and fertiliser.
- Create an adequate infrastructure and strong R and D base.

Different techniques and methods employed to maintain and provide specific environments in bioenergy will also be assessed. In order to evaluate the effectiveness of the suggested methods, a literature review is compiled and presented. Determine the suitability of biomass technology for heating, cooling and other applications. Verify and document the savings in energy use and demand that biomass may be expected to achieve.

2.1. Bioenergy Development

Bioenergy is energy from the sun stored in materials of biological origin. This includes plant matter and animal waste, known as biomass. Plants store solar energy through photosynthesis in cellulose and lignin, whereas animals store energy as fats. When burned, these sugars break down and release energy exothermically, releasing carbon dioxide (CO₂), heat and steam. The by-products of this reaction can be captured and manipulated to create power, commonly called bioenergy. Biomass is considered renewable because the carbon (C) is taken out of the atmosphere and replenished more quickly than the millions of years required for fossil fuels to form. The use of biofuels to replace fossil fuels contributes to a reduction in the overall release of carbon dioxide into the atmosphere and hence helps to tackle global warming [6].

Table 1. Sources of energy [7]

Energy source	Energy carrier	Energy end-use
Vegetation	Fuel-wood	Cooking Water heating Building materials Animal fodder preparation
Oil	Kerosene	Lighting Ignition fires
Dry cells	Dry cell batteries	Lighting

3rd International Conference on “Global Initiative in Agricultural, Forestry and Applied Sciences for Food Security, Environmental Safety and Sustainable Development (GIAFAS-2021)”

		Small appliances
Muscle power	Animal power	Transport Land preparation for farming Food preparation (threshing)
Muscle power	Human power	Transport Land preparation for farming Food preparation (threshing)

Table 2. Renewable applications [8]

Systems	Applications
Water supply	Rain collection, purification, storage and recycling
Wastes disposal	Anaerobic digestion (CH ₄)
Cooking	Methane
Food	Cultivate the 1 hectare plot and greenhouse for four people
Electrical demands	Wind generator
Space heating	Solar collectors
Water heating	Solar collectors and excess wind energy
Control system	Ultimately hardware
Building fabric	Integration of subsystems to cut costs

The biomass energy resources are particularly suited for the provision of rural power supplies and a major advantage is that equipment such as flat plate solar driers, wind machines, etc., can be constructed using local resources and without the high capital cost of more conventional equipment. Further advantage results from the feasibility of local maintenance and the general encouragement such local manufacture gives to the build up of small-scale rural based industry. Table 1 lists the energy sources available. Currently the ‘non-commercial’ fuels wood, crop residues and animal dung are used in large amounts in the rural areas of developing countries, principally for heating and cooking; the method of use is highly inefficient. Table 2, 3 and 4 presented some renewable applications, the most important of energy needs and methods of energy conversion respectively.

Considerations when selecting power plant include the following:

- Power level- whether continuous or discontinuous.
- Cost- initial cost, total running cost including fuel, maintenance and capital amortised over life.
- Complexity of operation.
- Maintenance and availability of spares.
- Life and suitability for local manufacture.

Table 3. Energy needs in rural areas [8]

Transport, e.g., small vehicles and boats
Agricultural machinery, e.g., two-wheeled tractors
Crop processing, e.g., milling
Water pumping
Small industries, e.g., workshop equipment
Electricity generation, e.g., hospitals and schools
Domestic, e.g., cooking, heating, and lighting

Table 4. Methods of energy conversion [10]

Muscle power	Man, animals
Internal combustion engines	
Reciprocating	Petrol- spark ignition Diesel- compression ignition Humphrey water piston
Rotating	Gas turbines

Heat engines	
Vapour (Rankine)	
Reciprocating	Steam engine
Rotating	Steam turbine
Gas Stirling (Reciprocating)	Steam engine
Gas Brayton (Rotating)	Steam turbine
Electron gas	Thermionic, thermoelectric
Electromagnetic radiation	Photo devices
Hydraulic engines	Wheels, screws, buckets, turbines
Wind engines (wind machines)	Vertical axis, horizontal axis
Electrical/mechanical	Dynamo/alternator, motor

The internal combustion engine is a major contributor to rising CO₂ emissions worldwide and some pretty dramatic new thinking is needed if our planet is to counter the effects. With its use increasing in developing world economies, there is something to be said for the argument that the vehicles we use to help keep our inner-city environments free from waste, litter and grime should be at the forefront of developments in low-emissions technology. Materials handled by waste management companies are becoming increasingly valuable. Those responsible for the security of facilities that treat waste or manage scrap will testify to the precautions needed to fight an ongoing battle against unauthorised access by criminals and crucially, to prevent the damage they can cause through theft, vandalism or even arson. Of particular concern is the escalating level of metal theft, driven by various factors including the demand for metal in rapidly developing economies such as India and China [9].

There is a need for greater attention to be devoted to this field in the development of new designs, the dissemination of information and the encouragement of its use. International and government bodies and independent organisations all have a role to play in biomass energy technologies. Environment has no precise limits because it is in fact a part of everything. Indeed, environment is, as anyone probably already knows, not only flowers blossoming or birds singing in the spring, or a lake surrounded by beautiful mountains. It is also human settlements, the places where people live, work, rest, the quality of the food we eat, the noise or silence of the street they live in. Environment is not only the fact that our cars consume a good deal of energy and pollute the air, but also, that we often need them to go to work and for holidays. Obviously man uses energy just as plants, bacteria, mushrooms, bees, fish and rats do (Figure 1). Man largely uses solar energy- food, hydropower, wood- and thus participates harmoniously in the natural flow of energy through the environment. But man also uses oil, gas, coal and nuclear power. We always modify our environment with or without this source of energy [11]. Economic importance of environmental issue is increasing, and new technologies are expected to reduce pollution derived both from productive processes and products, with costs that are still unknown. This is due to market uncertainty, weak appropriability regime, lack of a dominant design, and difficulties in reconfiguring organisational routines. The degradation of the global environment is one of the most serious energy issues [12].

3. Energy Use and the Environment

The range of waste treatment technologies that are tailored to produce bioenergy is growing. There are a number of key areas of bioenergy from wastes including (but not limited to) biogas, biofuels and bioheat.

Table 5. Annual GHG emissions from different types of power plants [13]

Primary source of energy	Emissions (x 10 ³ metric tons CO ₂)		Waste (x 10 ³ metric tons CO ₂)	Area (km ²)
	Atmosphere	Water		
Coal	380	7-41	60-3000	120

3rd International Conference on “Global Initiative in Agricultural, Forestry and Applied Sciences for Food Security, Environmental Safety and Sustainable Development (GIAFAS-2021)”

Oil	70-160	3-6	Negligible	70-84
Gas	24	1	-	84
Nuclear	6	21	2600	77

Table 6. Energy consumption per person [13]

Region	Population (millions)	Energy per person (Watt/m ²)
Africa	820	0.54
Asia	3780	2.74
Central America	180	1.44
North America	335	0.34
South America	475	0.52
Western Europe	445	2.24
Eastern Europe	130	2.57
Oceania	35	0.08
Russia	330	0.29

When considering using bioenergy, it is important to take into account the overall emission of carbon in the process of electricity production. Energy use is one of several essential components for every country:

- The overall situation and the implications of increased energy use in the future.

The problem of the provision of power in rural areas, including the consideration of energy resources and energy conversion. In addition to the drain on resources, such an increase in consumption consequences, together with the increased hazards of pollution and the safety problems associated with a large nuclear fission programmes. It would be equally unacceptable to suggest that the difference in energy between the developed and developing countries and prudent for the developed countries to move towards a way of life which, whilst maintaining or even increasing quality of life, reduce significantly the energy consumption per capita. Such savings can be achieved in a number of ways:

- Improved efficiency of energy use, for example environmental cost of thermal insulation must be taken into account, energy recovery, and total energy.
- Conservation of energy resources by design for long life and recycling rather than the short life throwaway product and systematic replanning of our way of life, for example in the field of transport.

Energy ratio (E_r) is defined as the ratio of Energy content (E_c) of the food product / Energy input (E_i) to produce the food.

$$E_r = E_c/E_i \quad (1)$$

Combined heat and power (CHP) installations are quite common in greenhouses, which grow high-energy, input crops (e.g., salad vegetables, pot plants, etc.). Scientific assumptions for a short-term energy strategy suggest that the most economically efficient way to replace the thermal plants is to modernise existing power plants to increase their energy efficiency and to improve their environmental performance (Pernille, 2004).

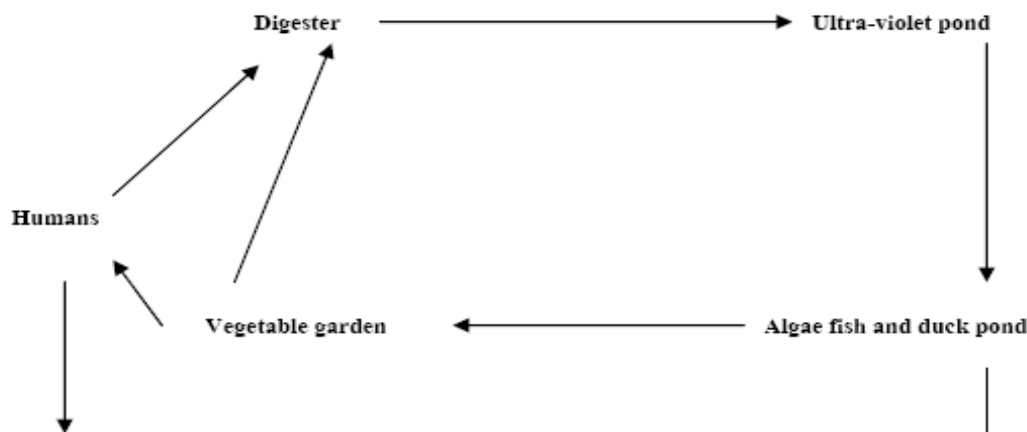

Figure 1. Biomass utilisation cycle concepts [14].

Table 7. Summary of material recycling practices in the construction sector [15]

Construction and demolition material	Recycling technology options	Recycling product
Asphalt	Cold recycling: heat generation; Minnesota process; parallel drum process; elongated drum; microwave asphalt recycling system; finfalt; surface regeneration	Recycling asphalt; asphalt aggregate
Brick	Burn to ash, crush into aggregate	Slime burn ash; filling material; hardcore
Concrete	Crush into aggregate	Recycling aggregate; cement replacement; protection of levee; backfilling; filter
Ferrous metal	Melt; reuse directly	Recycled steel scrap
Glass	Reuse directly; grind to powder; polishing; crush into aggregate; burn to ash	Recycled window unit; glass fibre; filling material; tile; paving block; asphalt; recycled aggregate; cement replacement; manmade soil
Masonry	Crush into aggregate; heat to 900°C to ash	Thermal insulating concrete; traditional clay
Non-ferrous metal	Melt	Recycled metal
Paper and cardboard	Purification	Recycled paper
Plastic	Convert to powder by cryogenic milling; clopping; crush into aggregate; burn to ash	Panel; recycled plastic; plastic lumber; recycled aggregate; landfill drainage; asphalt; manmade soil
Timber	Reuse directly; cut into aggregate; blast furnace deoxidisation; gasification or pyrolysis; chipping; moulding by pressurising timber chip under steam and water	Whole timber; furniture and kitchen utensils; lightweight recycled aggregate; source of energy; chemical production; wood-based panel; plastic lumber; geofibre; insulation board

Combined heat and power (CHP) installations are quite common in greenhouses, which grow high-energy, input crops (e.g., salad vegetables, potted plants, etc.). Scientific assumptions for a short-term energy strategy suggest that the most economically efficient way to replace the thermal plants is to modernise

existing power plants to increase their energy efficiency and to improve their environmental performance [15]. However, utilisation of wind power and the conversion of gas-fired CHP plants to biomass would significantly reduce the dependence on imported fossil fuels. Although a lack of generating capacity is forecasted in the long-term, utilisation of the existing renewable energy potential and the huge possibilities for increasing energy efficiency are sufficient to meet future energy demands in the short-term [15]

A total shift towards a sustainable energy system is a complex and long process, but is one that can be achieved within a period of about 20 years. Implementation will require initial investment, long-term national strategies and action plans. However, the changes will have a number of benefits including a more stable energy supply than at present and major improvement in the environmental performance of the energy sector, and certain social benefits (Figure 2). A vision that used methodologies and calculations based on computer modelling can be utilised:

- Data from existing governmental programmes.
- Potential renewable energy sources and energy efficiency improvements.
- Assumptions for future economy growth.
- Information from studies and surveys on the recent situation in the energy sector.

The main advantages are related to energy, agriculture and environment problems, are foreseeable both at national and interernational level can be summarised as follows:

- Reduction of dependence on import of energy and related products.
- Reduction of environmental impact of energy production (greenhouse effect, air pollution, and waste degradation).
- Substitution of food crops and reduction of food surpluses and of related economic burdens, and development of new know-how and production of technological innovation.
- Utilisation of marginal lands and of set aside lands and reduction of related socio-economic and environmental problems (soil erosion, urbanisation, landscape deterioration, etc.).

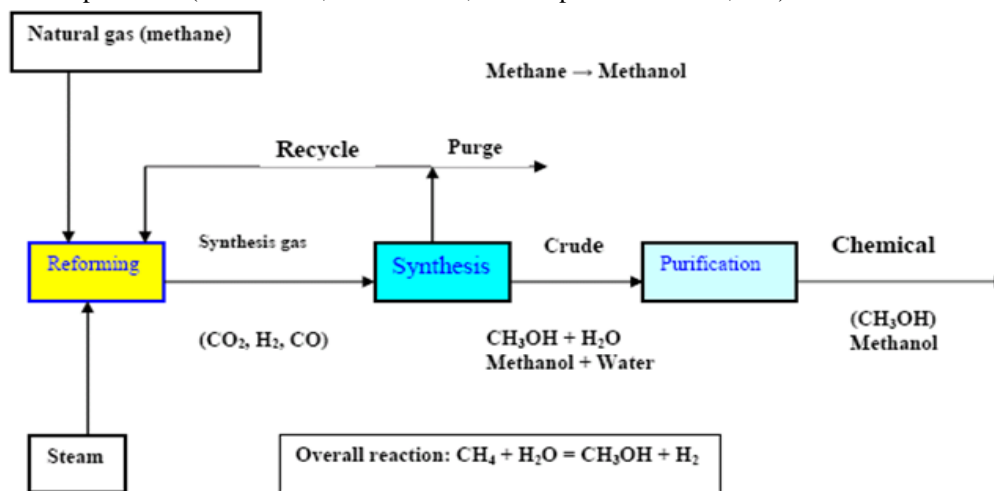

Figure 2. Schematic diagram shows methanol production [16].

In some countries, a wide range of economic incentives and other measures are already helping to protect the environment. These include:

3rd International Conference on “Global Initiative in Agricultural, Forestry and Applied Sciences for Food Security, Environmental Safety and Sustainable Development (GIAFAS-2021)”

- Taxes and user charges that reflect the costs of using the environment, e.g., pollution taxes and waste disposal charges.
- Subsidies, credits and grants that encourage environmental protection.
- Deposit-refund systems that prevent pollution on resource misuse and promote product reuse or recycling.
- Financial enforcement incentives, e.g., fines for non-compliance with environmental regulations.
- Tradable permits for activities that harm the environment.

District Heating (DH), also known as community heating can be a key factor to achieve energy savings, reduce CO₂ emissions and at the same time provide consumers with a high quality heat supply at a competitive price. The DH should generally only be considered for areas where the heat density is sufficiently high to make DH economical. In countries like Denmark DH may today be economical even to new developments with lower density areas due to the high level of taxation on oil and gas fuels combined with the efficient production of the DH. To improve the opportunity for the DH local councils can adapt the following plan:

- Analyse the options for heat supply during local planning stage.
- In areas where DH is the least cost solution it should be made part of the infrastructure just like for instance water and sewage connecting all existing and new buildings.
- Where possible all public buildings should be connected to the DH.
- The government provides low interest loans or funding to minimise conversion costs for its citizens.
- Use other powers, for instance national legislation to ensure the most economical development of the heat supply and enable an obligation to connect buildings to a DH scheme.

Denmark has broadly seen three scales of the CHP which where largely implemented in the following chronological order (Pernille, 2004):

- Large-scale CHP in cities (>50 MWe).
- Small (5 kWe – 5 MWe) and medium-scale (5-50 MWe).
- Industrial and small-scale CHP.

Combined heat and power (CHP) installations are quite common in greenhouses, which grow high-energy, input crops (e.g., salad vegetables, pot plants, etc.). Most of the heat is produced by large CHP plants (gas-fired combined cycle plants using natural gas, biomass, waste or biogas). DH is energy efficient because of the way the heat is produced and the required temperature level is an important factor. Buildings can be heated to temperature of 21°C and domestic hot water (DHW) can be supplied with a temperature of 55°C using energy sources that are most efficient when producing low temperature levels (<95°C) for the DH water. Most of these heat sources are CO₂ neutral or emit low levels. Only a few of these sources are available to small individual systems at a reasonably cost, whereas DH schemes because of the plant's size and location can have access to most of the heat sources and at a low cost. Low temperature DH, with return temperatures of around 30-40°C can utilise the following heat sources:

- Efficient use of the CHP by extracting heat at low calorific value (CV).
- Efficient use of biomass or gas boilers by condensing heat in economisers (Table 8).
- Efficient utilisation of geothermal energy.
- Direct utilisation of excess low temperature heat from industrial processes.
- Efficient use of large-scale solar heating plants.

Heat tariffs may include a number of components such as a connection charge, a fixed charge and a variable energy charge. Also, consumers may be incentivised to lower the return temperature. Hence, it is difficult to generalise but the heat practice for any DH company no matter what the ownership structure can be highlighted as follows:

- To develop and maintain a development plan for the connection of new consumers and to evaluate the options for least cost production of heat.

3rd International Conference on “Global Initiative in Agricultural, Forestry and Applied Sciences for Food Security, Environmental Safety and Sustainable Development (GIAFAS-2021)”

- To implement the most competitive solutions by signing agreements with other companies or by implementing own investment projects.
- To monitor all internal costs and with the help of benchmarking, and improve the efficiency of the company.
- To maintain a good relationship with the consumer and deliver heat supply services at a sufficient quality.

Table 8. Final energy projections including biomass (Mtoe) [17]

Region 2011				
	Biomass	Conventional Energy	Total	Share of Biomass (%)
Africa	205	136	341	60
China	206	649	855	24
East Asia	106	316	422	25
Latin America	73	342	415	18
South Asia	235	188	423	56
Total developing countries	825	1632	2457	34
Other non-OECD * countries	24	1037	1061	2
Total non-OECD* countries	849	2669	3518	24
OECD countries	81	3044	3125	3
World	930	5713	6643	14
Region 2020				
Africa	371	266	637	59
China	224	1524	1748	13
East Asia	118	813	931	13

Table 8. (Continued)

Region 2011				
	Biomass	Conventional Energy	Total	Share of Biomass (%)
Latin America	81	706	787	10
South Asia	276	523	799	35
Total developing countries	1071	3825	4896	22
Other non-OECD * countries	26	1669	1695	2
Total non-OECD* countries	1097	5494	6591	17
OECD countries	96	3872	3968	2
World	1193	9365	10558	11

* Organisation for Economic Co-operation and Development

Installing DH should be pursued to meet the objectives for improving the environment through the improvement of energy efficiency in the heating sector. At the same time DH can serve the consumer with a reasonable quality of heat at the lowest possible cost. The variety of possible solutions combined with the collaboration between individual companies, the district heating association, the suppliers and consultants can, as it has been in Denmark, be the way forward for developing DH in the United Kingdom. Implementation will require initial investment, long-term national strategies and action plans. However, the changes will have a number of benefits including a more stable energy supply than at present and major improvement in the environmental performance of the energy sector, and certain social benefits (Pernille, 2004).

4. Biomass Utilisation and Development of Conversion Technologies: Sustainable energy is energy that, in its production or consumption, has minimal negative impacts on human health and the healthy functioning of vital ecological systems, including the global environment. It is an accepted fact that renewable energy is a sustainable form of energy, which has attracted more attention during recent years. A great amount of renewable energy potential, environmental interest, as well as economic consideration of fossil fuel consumption and high emphasis of sustainable development for the future will be needed. Explanations for the use of inefficient agricultural-environmental policies include: the high cost of information required to measure benefits on a site-specific basis, information asymmetries between government agencies and farm decision makers that result in high implementation costs, distribution effects and political considerations [18]. Achieving the aim of agric-environment schemes through:

- Sustain the beauty and diversity of the landscape.
- Improve and extend wildlife habitats.
- Conserve archaeological sites and historic features.
- Improve opportunities for countryside enjoyment.
- Restore neglected land or features, and
- Create new habitats and landscapes.

The data required to perform the trade-off analysis simulation can be classified according to the divisions given in Table 9: the overall system or individual plants, and the existing situation or future development. The effective economic utilisations of these resources are shown in Table 10, but their use is hindered by many problems such as those related to harvesting, collection, and transportation, besides the sanitary control regulations. Biomass energy is experiencing a surge in an interest stemming from a combination of factors, e.g., greater recognition of its current role and future potential contribution as a modern fuel, global environmental benefits, its development and entrepreneurial opportunities, etc. Possible routes of biomass energy development are shown in Table 11.

The key to successful future appears to lie with successful marketing of the treatment by products. There is also potential for using solid residue in the construction industry as a filling agent for concrete. Research suggests that the composition of the residue locks metals within the material, thus preventing their escape and any subsequent negative effect on the environment [19]. The use of biomass through direct combustion has long been, and still is, the most common mode of biomass utilisation as shown in Tables (9-11). Examples for dry (thermo-chemical) conversion processes are charcoal making from wood (slow pyrolysis), gasification of forest and agricultural residues (fast pyrolysis – this is still in demonstration phase), and of course, direct combustion in stoves, furnaces, etc. Wet processes require substantial amount of water to be mixed with the biomass. Biomass technologies include:

- Briquetting.
- Improved stoves.
- Biogas.
- Improved charcoal.
- Carbonisation.
- Gasification.

Table 9. Classifications of data requirements [20]

Item	Plant data	System data
Existing data	Size Life Cost (fixed and var. O and M) Forced outage Maintenance	Peak load Load shape Capital costs Fuel costs Depreciation

Item	Plant data	System data
	Efficiency Fuel Emissions	Rate of return Taxes
Future data	All of above, plus Capital costs Construction trajectory Date in service	System lead growth Fuel price growth Fuel import limits Inflation

Table 10. Agricultural residues routes for development [20]

Source	Process	Product	End use
Agricultural residues	Direct	Combustion	Rural poor Urban household Industrial use
	Processing	Briquettes	Industrial use Limited household use
	Processing	Carbonisation (small-scale)	Rural household (self sufficiency) Urban fuel
	Carbonisation Fermentation	Briquettes Carbonised Biogas	Energy services Household Industry
Agricultural, and animal residues	Direct	Combustion	(Save or less efficiency as wood) (Similar end use devices or improved)
	Briquettes	Direct combustion	Use Briquettes use
	Carbonisation	Carbonised	Use
	Carbonisation Fermentation	Briquettes Biogas	Use

The increased demand for gas and petroleum, food crops, fish and large sources of vegetative matter mean that the global harvesting of carbon has in turn intensified. It could be said that mankind is mining nearly everything except its waste piles. It is simply a matter of time until the significant carbon stream present in municipal solid waste is fully captured. In the meantime, the waste industry needs to continue on the pathway to increased awareness and better-optimised biowaste resources. Optimisation of waste carbon may require widespread regulatory drivers (including strict limits on the landfilling of organic materials), public acceptance of the benefits of waste carbon products for soil improvements/crop enhancements and more investment in capital facilities [21]. In short, a significant effort will be required in order to capture a greater portion of the carbon stream and put it to beneficial use. From the standpoint of waste practitioners, further research and pilot programmes are necessary before the available carbon in the waste stream can be extracted in sufficient quality and quantities to create the desired end products. Other details need to be ironed out too, including measurement methods, diversion calculations, sequestration values and determination of acceptance contamination thresholds [22].

5.1. Briquette production

Charcoal stoves are very familiar to African society. As for the stove technology, the present charcoal stove can be used, and can be improved upon for better efficiency. This energy term will be of particular interest to both urban and rural households and all the income groups due to the simplicity, convenience, and lower air polluting characteristics. However, the market price of the fuel together with that of its end-use technology may not enhance its early high market penetration especially in the urban low income and rural households.

Table 11. Effective biomass resource utilisation [22]

3rd International Conference on “Global Initiative in Agricultural, Forestry and Applied Sciences for Food Security, Environmental Safety and Sustainable Development (GIAFAS-2021)”

Subject	Tools	Constraints
Utilisation and land clearance for agriculture expansion	Stumpage fees Control Extension Conversion Technology	Policy Fuel-wood planning Lack of extension Institutional
Utilisation of agricultural residues	Briquetting Carbonisation Carbonisation and briquetting Fermentation Gasification	Capital Pricing Policy and legislation Social acceptability

Briquetting is the formation of a charcoal (an energy-dense solid fuel source) from otherwise wasted agricultural and forestry residues. One of the disadvantages of wood fuel is that it is bulky with a low energy density and is therefore enquire to transport. Briquette formation allows for a more energy-dense fuel to be delivered, thus reducing the transportation cost and making the resource more competitive. It also adds some uniformity, which makes the fuel more compatible with systems that are sensitive to the specific fuel input [23].

5.2. Improved cook stoves

Traditional wood stoves can be classified into four types: three stone, metal cylindrical shaped, metal tripod and clay type [24]. Another area in which rural energy availability could be secured where woody fuels have become scarce, are the improvements of traditional cookers and ovens to raise the efficiency of fuel saving. Also, to provide a constant fuel supply by planting fast growing trees. The rural development is essential and economically important since it will eventually lead to better standards of living, people’s settlement, and self sufficient in the following:

- Food and water supplies.
- Better services in education and health care.
- Good communication modes.

5.3. Biogas technology

Biogas technology cannot only provide fuel, but is also important for comprehensive utilisation of biomass forestry, animal husbandry, fishery, agricultural economy, protecting the environment, realising agricultural recycling, as well as improving the sanitary conditions, in rural areas. The introduction of biogas technology on wide scale has implications for macro planning such as the allocation of government investment and effects on the balance of payments. Factors that determine the rate of acceptance of biogas plants, such as credit facilities and technical backup services, are likely to have to be planned as part of general macro-policy, as do the allocation of research and development funds [25].

Biogas is a generic term for gases generated from the decomposition of organic material. As the material breaks down, methane (CH₄) is produced as shown in Figure 3. Sources that generate biogas are numerous and varied. These include landfill sites, wastewater treatment plants and anaerobic digesters. Landfills and wastewater treatment plants emit biogas from decaying waste. To date, the waste industry has focused on controlling these emissions to our environment and in some cases, tapping this potential source of fuel to power gas turbines, thus generating electricity. The primary components of landfill gas are methane (CH₄), carbon dioxide (CO₂), and nitrogen (N₂). The average concentration of methane is ~45%, CO₂ is ~36% and nitrogen is ~18%. Other components in the gas are oxygen (O₂), water vapour and trace amounts of a wide range of non-methane organic compounds (NMOCs).

For hot water and heating, renewables contributions come from biomass power and heat, geothermal direct heat, ground source heat pumps, and rooftop solar hot water and space heating systems. Solar assisted cooling makes a very small but growing contribution. When it comes to the installation of large amounts of the PV, the cities have several important factors in common. These factors include [25]:

- A strong local political commitment to the environment and sustainability.
- The presence of municipal departments or offices dedicated to the environment, and sustainability or renewable energy.
- Information provision about the possibilities of renewables.
- Obligations that some or all buildings include renewable energy.

5.4. Improved forest and tree management

Dry cell batteries are a practical but expensive form of mobile fuel that is used by rural people when moving around at night and for powering radios and other small appliances. The high cost of dry cell batteries is financially constraining for rural households, but their popularity gives a good indication of how valuable a versatile fuel like electricity is in rural area. Dry cell batteries can constitute an environmental hazard unless they are recycled in a proper fashion. Direct burning of fuel-wood and crop residues constitute the main usage of biomass, as is the case with many developing countries. However, the direct burning of biomass in an inefficient manner causes economic loss and adversely affects human health. In order to address the problem of inefficiency, research centres around the world have investigated the viability of converting the resource to a more useful form, namely solid briquettes and fuel gas (Figure 4). Biomass resources play a significant role in energy supply in all developing countries. Biomass resources should be divided into residues or dedicated resources, the latter including firewood and charcoal can also be produced from forest residues (Table 12).

Implementing measures for energy efficiency increase at the demand side and in the energy transformation sector is important. It is common practice to dispose of this waste wood in landfill where it slowly degraded and takes up valuable void space. This wood is a good source of energy and is an alternative to energy crops. Agricultural wastes are abundantly available globally and can be converted to energy and useful chemicals by a number of microorganisms. The success of promoting any technology depends on careful planning, management, implementation, training and monitoring. Main features of gasification project are:

- Networking and institutional development/strengthening.
- Promotion and extension.
- Construction of demonstration projects.
- Research and development, and training and monitoring.

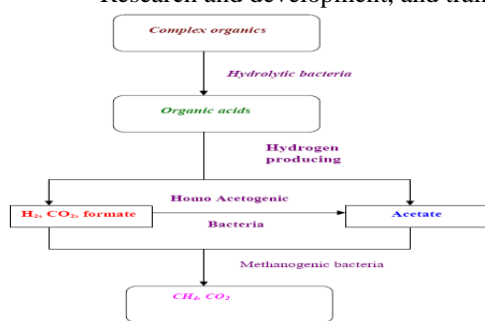

Figure 3. Biogas production process [26].

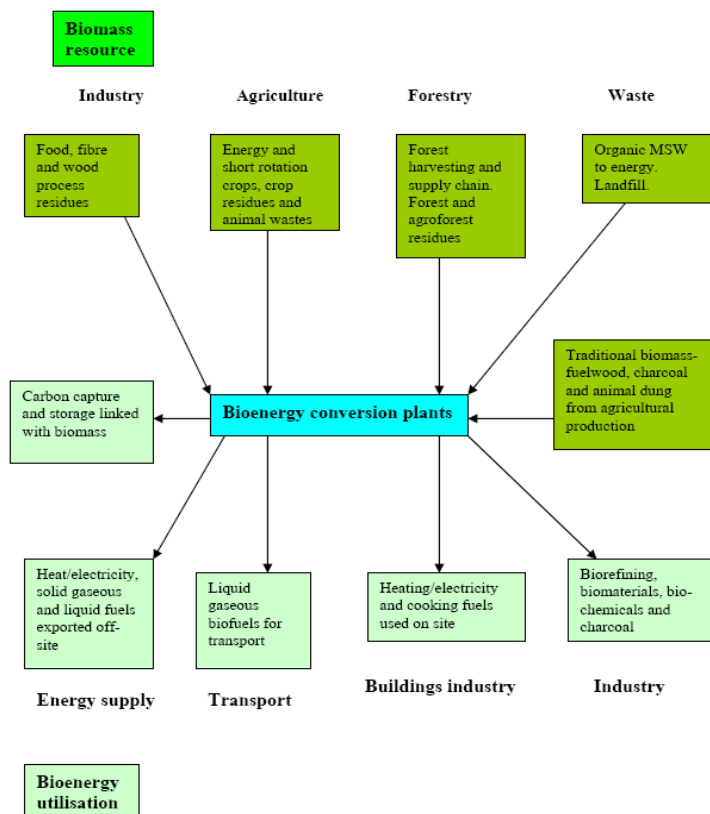

Figure 4. Biomass resources from several sources are converted into a range of products for use by transport, industry and building sectors [27].

5.5. Gasification processes

Gasification is based on the formation of a fuel gas (mostly CO and H₂) by partially oxidising raw solid fuel at high temperatures in the presence of steam or air. The technology can use wood chips, groundnut shells, sugar cane bagasse, and other similar fuels to generate capacities from 3 kW to 100 kW. Three types of gasifier designs have been developed to make use of the diversity of fuel inputs and to meet the requirements of the product gas output (degree of cleanliness, composition, heating value, etc.). The requirements of gas for various purposes, and a comparison between biogas and various commercial fuels in terms of calorific value, and thermal efficiency are presented in Table 13. Sewage sludge is rich in nutrients such as nitrogen and phosphorous. It also contains valuable organic matter, useful for remediation of depleted or eroded soils. This is why untreated sludge has been used for many years as a soil fertiliser and for enhancing the organic matter of soil. A key concern is that treatment of sludge tends to concentrate heavy metals, poorly biodegradable trace organic compounds and potentially pathogenic organisms (viruses, bacteria and the like) present in wastewaters. These materials can pose a serious threat to the environment. When deposited in soils, heavy metals are passed through the food chain, first entering crops, and then animals that feed on the crops and eventually human beings, to whom they appear to be highly toxic. In addition they also leach from soils, getting into groundwater and further spreading contamination in an uncontrolled manner [28].

Table 12. Biomass residues and current use [28]

Type of residue	Current use
Wood industry waste	Residues available
Vegetable crop residues	Animal feed

3rd International Conference on “Global Initiative in Agricultural, Forestry and Applied Sciences for Food Security, Environmental Safety and Sustainable Development (GIAFAS-2021)”

Food processing residue	Energy needs
Sorghum, millet, and wheat residues	Fodder, and building materials
Groundnut shells	Fodder, brick making, and direct fining oil mills
Cotton stalks	Domestic fuel considerable amounts available for short period
Sugar, bagasse, and molasses	Fodder, energy need, and ethanol production (surplus available)
Manure	Fertiliser, brick making, and plastering

European and American markets aiming to transform various organic wastes (animal farm wastes, industrial and municipal wastes) into two main by-products:

- A solution of humic substances (a liquid oxidate).
- A solid residue.

Agricultural wastes are abundantly available globally and can be converted to energy and useful chemicals by a number of microorganisms. The organic matter was biodegradable to produce biogas and the variation show a normal methanogene bacteria activity and good working biological process as shown in Figures 5-7. The success of promoting any technology depends on careful planning, management, implementation, training and monitoring. Main features of gasification project are:

- Networking and institutional development/strengthening.
- Promotion and extension.
- Construction of demonstration projects.
- Research and development, and training and monitoring.

Biomass is a raw material that has been utilised for a wide variety of tasks since the dawn of civilisation. Important as a supply of fuel in the third world, biomass was also the first raw material in the production of textiles. The gasification of the carbon char with steam can make a large difference to the surface area of the carbon. The corresponding steam gasification reactions are endothermic and demonstrate how the steam reacts with the carbon charcoal (Bacaoui, 1998).

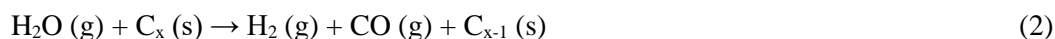

Table 13. Comparison of various fuels [28]

Fuel	Calorific value (kcal)	Burning mode	Thermal efficiency (%)
Electricity, kWh	880	Hot plate	70
Coal gas, kg	4004	Standard burner	60
Biogas, m ³	5373	Standard burner	60
Kerosene, l	9122	Pressure stove	50
Charcoal, kg	6930	Open stove	28
Soft coke, kg	6292	Open stove	28
Firewood, kg	3821	Open stove	17
Cow dung, kg	2092	Open stove	11

The sources to alleviate the energy situation in the world are sufficient to supply all foreseeable needs. Conservation of energy and rationing in some form will however have to be practised by most countries, to reduce oil imports and redress balance of payments positions. Meanwhile development and application of nuclear power and some of the traditional solar, wind and water energy alternatives must be set in hand to supplement what remains of the fossil fuels.

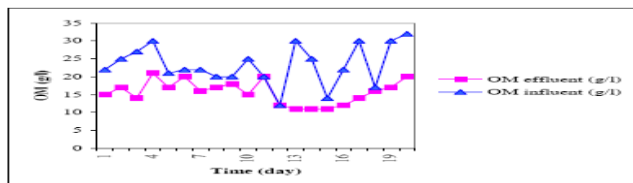

Figure 5. Organic matters before and after treatment in digester [29].

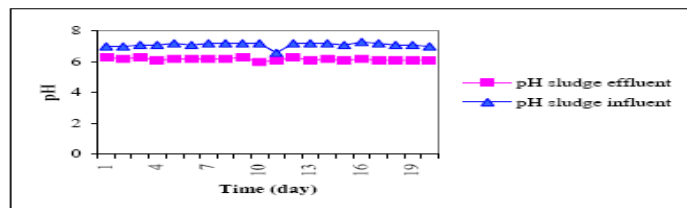

Figure 6. Potential of hydrogen (pH) sludge before and after treatment in the digester [29].

The encouragement of greater energy use is an essential component of development. In the short-term it requires mechanisms to enable the rapid increase in energy/capita, and in the long-term we should be working towards a way of life, which makes use of energy efficiency and without the impairment of the environment or of causing safety problems. Such a programme should as far as possible be based on renewable energy resources.

Table 14. Biomass conversions to energy [29]

Feedstock	Crops	Conversion process	End product
Wood-cellulosic biomass	Short rotation forest (poplar, willow), plant species (sorghum, miscanthus, etc.), fibre-crops (cynara, kenaf, etc.)	Direct combustion	Heat
		Gasification	Methane
		Pyrolysis	Hydrogen
Vegetable oils	Oleaginous crops (rapeseed, soybean, sunflower, etc.)		Oil
Sugar/starch	Cereals, root and tuber crops, grape, topinambour, etc.	Direct combustion	Heat
		Esterification	Biodiesel
		Fermentation	Ethanol

6. Bioheat

Bioenergy is a growing source of power that is playing an ever-increasing role in the provision of electricity. The potential contribution of the waste industry to bioenergy is huge and has the ability to account for a source of large amount of total bioenergy production. Woody biomass is usually converted into power through combustion or gasification. Biomass can be specially grown in the case of energy crops. Waste wood makes up a significant proportion of a variety of municipal, commercial and industrial waste streams. It is common practice to dispose of this waste wood in landfill where it slowly degraded and takes up valuable void space. This wood is a good source of energy and is an alternative to energy crops. The biomass directly produced by cultivation can be transformed by different processes into gaseous, liquid or solid fuels (Table 14). The whole process of production of methyl or ethyl esters (biodiesel) is summarised in Figures 8-9.

In Figure 7 Advanced biomass power with diesel engine at equilibrium, the rate at which vapour is formed (determined by Q_1) equals the rate at which it is removed. Therefore, both the heat transfer rate into the liquid (Q_2) and the vapour removal rate (suction pump capacity) determines the pressure cooling capacity, i.e., Q_3 ; Q_4 Capacity (thermal power) (Watt); External heat input i.e., W_1 ; W_2 Heat (thermal energy) (J),

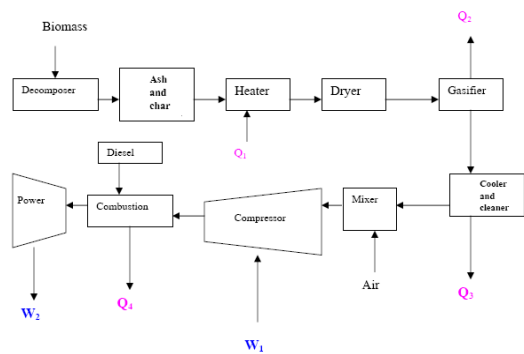

Figure 7. Advanced biomass power with diesel engine [30].

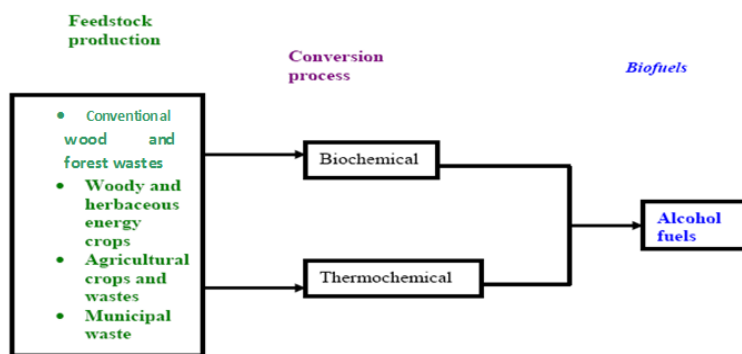

Figure 8. Biofuel pathways for renewable alcohol fuels [30].

6.1. Waste policy in context

In terms of solid waste management policy, many non-governmental organisations (NGOs) have changed drastically in the past ten years from a mass production and mass consumption society to ‘material-cycle society’. In addition to national legislation, municipalities are legally obliged to develop a plan for handling the municipal solid waste (MSW) generated in administrative areas. Such plans contain:

- Estimates of future waste volume.
- Measures to reduce waste.
- Measures to encourage source separation.
- A framework for solid waste disposal and the construction and management of solid waste management facilities.

Landfilling is in the least referred tier of the hierarchy of waste management options: waste minimisation, reuse and recycling, incineration with energy recovery, and optimised final disposal. The key elements are as follows: construction impacts, atmospheric emissions, noise, water quality, landscape, visual impacts, socio economics, ecological impacts, traffic, solid waste disposal and cultural heritage [31].

6.2. Energy from agricultural biomass

The main advantages are related to energy, agriculture and environment problems, are foreseeable both at regional level and at worldwide level and can be summarised as follows:

- Reduction of dependence on import of energy and related products.
- Reduction of environmental impact of energy production (greenhouse effect, air pollution, and waste degradation).

- Substitution of food crops and reduction of food surpluses and of related economic burdens.
- Utilisation of marginal lands and of set aside lands and reduction of related socio-economic and environmental problems (soil erosion, urbanisation, landscape deterioration, etc.).
- Development of new know-how and production of technological innovation.

A study (Bacoui, 1998) individuated on the basis of botanical, genetical, physiological, biochemical, agronomical and technological knowledge reported in literature some 150 species potentially exploitable divided as reported in Table 15.

7. Role of Chemical Engineering

Turning to chemical engineering and the experience of the chemical process industry represents a wakening up but does not lead to an immediate solution to the problems. The traditional techniques are not very kind to biological products, which are controlled by difficulty and unique physico-chemical properties such as low mechanical, thermal and chemical stabilities. There is the question of selectivity.

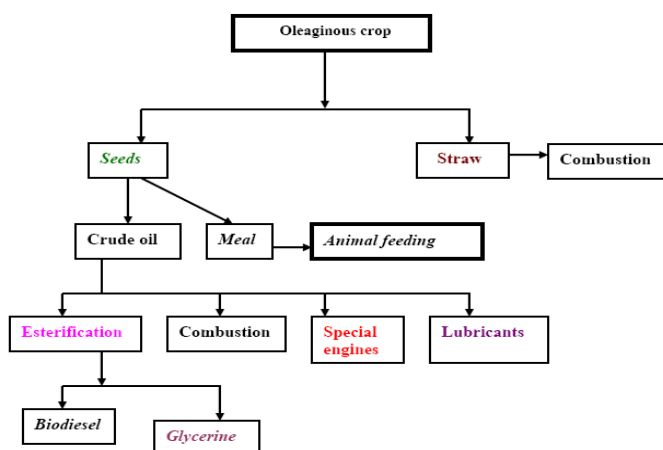

Figure 9. Flow chart of biodiesel production [32].

Table 15. Plant species potentially exploitable for production of agricultural biomass for energy or industrial utilisations [32]

Groups of plants	Number of species
Plants cultivated for food purposes that can be reconverted to new uses	9
Plants cultivated in the past, but not in culture any more	46
Plants cultivated in other world areas	46
Wild species, both indigenous and exotic	47
Total	148
Plant product	Number of species
Biomass	8
Sugars and polysaccharides	38
Cellulose	17
Hydrocarbons	3
Polymeric hydrocarbons	5
Gums and resins	12
Tannins and phenolic compounds	3
Waxes	7
Vegetable oils	38
Total	131

The fermentation broths resulting from microbial growth contain a bewildering mixture of many compounds closely related to the product of interests. By the standards of the process streams in chemical industry, fermenter is highly impure and extremely dilutes aqueous systems (Table 16).

Table 16. Typical product concentrations exiting fermenters [32]

Product	Concentration (kg/m ³)
Ethanol	70-120
Organic acids (e.g., citric)	40-100
Vitamin B12	0.02
Interferon	50-70
Single-cell protein	30-50
Antibiotics (e.g., Penicillin G)	10-30
Enzyme protein (e.g., protease)	2-5

The disadvantages of the fermentation media are as the following: mechanically fragile, temperature sensitive, rapidly deteriorating quality, harmful if escaping into the environment, corrosive (acids, chlorides, etc.), and troublesome (solids, theological, etc.), and expensive. Thus, pilot plants for scale-up work must be flexible. In general, they should contain suitably interconnected equipment for: fermentation, primary separation, cell disruption fractionalises and clarifications, purification by means of high-resolution techniques and concentration and dry. The effects of the chlorofluorocarbons (CFCs) molecule can last for over a century.

7.1. Fluidised bed drying

An important consideration for operators of wastewater treatment plants is how to handle the disposal of the residual sludge in a reliable, sustainable, legal and economical way. The benefits of drying sludge can be seen in two main treatment options:

- Use of the dewatered sludge as a fertiliser or in fertiliser blends.
- Incineration with energy recovery.

Use as a fertiliser takes advantage of the high organic content 40%-70% of the dewatered sludge and its high levels of phosphorous and other nutrients. However, there are a number of concerns about this route including:

- The chemical composition of the sludge (e.g., heavy metals, hormones and other pharmaceutical residues).
- Pathogen risk (e.g., SALMOELLA, ESCHERICHIA COLI, prionic proteins, etc.).
- Potential accumulation of heavy metals and other chemicals in the soil.

Sludge can be applied as a fertiliser in three forms: liquid sludge, wet cake blended into compost, and dried granules.

The advantages of energy recovery sludge include:

- The use of dewatered sludge is a ‘sink’ for pollutants such as heavy metals, toxic organic compounds and pharmaceutical residues. Thus, offering a potential disposal route for these substances provided the combustion plant has adequate flue gas cleaning.
- The potential, under certain circumstances, to utilise the inorganic residue from sludge incineration (incinerator ash), such as in cement or gravel.
- The high calorific value (similar to lignite) of dewatered sludge.
- The use of dewatered sludge as a carbon dioxide neutral substitute for primary fuels such as oil, gas and coal.

7.2. Energy efficiency

Energy efficiency is the most cost-effective way of cutting carbon dioxide emissions and improvements to households and businesses. It can also have many other additional social, economic and health benefits, such as warmer and healthier homes, lower fuel bills and company running costs and, indirectly, jobs. Britain wastes 20 per cent of its fossil fuel and electricity use in transportation (Omer, 2006). This implies that it would be cost-effective to cut £10 billion a year off the collective fuel bill and reduce CO₂ emissions by some 120 million tones CO₂ [33]. Yet, due to lack of good information and advice on energy saving, along with the capital to finance energy efficiency improvements, this huge potential for reducing energy demand is not being realised. Traditionally, energy utilities have been essentially fuel providers and the industry has pursued profits from increased volume of sales. Institutional and market arrangements have favoured energy consumption rather than conservation. However, energy is at the centre of the sustainable development paradigm as few activities affect the environment as much as the continually increasing use of energy. Most of the used energy depends on finite resources, such as coal, oil, gas and uranium. In addition, more than three quarters of the world’s consumption of these fuels is used, often inefficiently, by only one quarter of the world’s population. Without even addressing these inequities or the precious, finite nature of these resources, the scale of environmental damage will force the reduction of the usage of these fuels long before they run out.

Throughout the energy generation process there are impacts on the environment on local, national and international levels, from opencast mining and oil exploration to emissions of the potent greenhouse gas carbon dioxide in ever increasing concentration. Recently, the world’s leading climate scientists reached an agreement that human activities, such as burning fossil fuels for energy and transport, are causing the world’s temperature to rise. The Intergovernmental Panel on Climate Change has concluded that “the balance of evidence suggests a discernible human influence on global climate”. It predicts a rate of warming greater than any one seen in the last 10,000 years, in other words, throughout human history. The exact impact of climate change is difficult to predict and will vary regionally. It could, however, include sea level rise, disrupted agriculture and food supplies and the possibility of more freak weather events such as hurricanes and droughts. Indeed, people already are waking up to the financial and social, as well as the environmental, risks of unsustainable energy generation methods that represent the costs of the impacts of climate change, acid rain and oil spills. The insurance industry, for example, concerned about the billion dollar costs of hurricanes and floods, has joined sides with environmentalists to lobby for greenhouse gas emissions reduction. Friends of the earth are campaigning for a more sustainable energy policy, guided by the principal of environmental protection and with the objectives of sound natural resource management and long-term energy security. The key priorities of such an energy policy must be to reduce fossil fuel use, move away from nuclear power, improve the efficiency with which energy is used and increase the amount of energy obtainable from sustainable and renewable sources. Efficient energy use has never been more crucial than it is today, particularly with the prospect of the imminent introduction of the climate change levy (CCL). Establishing an energy use action plan is the essential foundation to the elimination of energy waste. A logical starting point is to carry out an energy audit that enables the assessment of the energy use and determine what actions to take. The actions are best categorised by splitting measures into the following three general groups:

(1) High priority/low cost:

These are normally measures, which require minimal investment and can be implemented quickly. The followings are some examples of such measures:

3rd International Conference on “Global Initiative in Agricultural, Forestry and Applied Sciences for Food Security, Environmental Safety and Sustainable Development (GIAFAS-2021)”

- Good housekeeping, monitoring energy use and targeting waste-fuel practices.
- Adjusting controls to match requirements.
- Improved greenhouse space utilisation.
- Small capital item time switches, thermostats, etc.
- Carrying out minor maintenance and repairs.
- Staff education and training.
- Ensuring that energy is being purchased through the most suitable tariff or contract arrangements.

(2) Medium priority/medium cost:

Measures, which, although involve little or no design, involve greater expenditure and can take longer to implement. Examples of such measures are listed below:

- New or replacement controls.
- Greenhouse component alteration, e.g., insulation, sealing glass joints, etc.
- Alternative equipment components, e.g., energy efficient lamps in light fittings, etc.

(3) Long term/high cost:

These measures require detailed study and design. They can be best represented by the followings:

- Replacing or upgrading of plant and equipment.
- Fundamental redesign of systems, e.g., CHP installations.

This process can often be a complex experience and therefore the most cost-effective approach is to employ an energy specialist to help.

7.3. Future recommended sustainable energy policy

Sustainability is regarded as a major consideration for both urban and rural development. People have been exploiting the natural resources with no consideration to the effects, both short-term (environmental) and long-term (resources crunch). It is also felt that knowledge and technology have not been used effectively in utilising energy resources. Energy is the vital input for economic and social development of any country. Its sustainability is an important factor to be considered. The urban areas depend, to a large extent, on commercial energy sources. The rural areas use non-commercial sources like firewood and agricultural wastes. With the present day trends for improving the quality of life and sustenance of mankind, environmental issues are considered highly important. In this context, the term energy loss has no significant technical meaning. Instead, the exergy loss has to be considered, as destruction of exergy is possible. Hence, exergy loss minimisation will help in sustainability. In the process of developing, there are two options to manage energy resources: (1) End use matching/demand side management, which focuses on the utilities. The mode of obtaining this is decided based on economic terms. It is, therefore, a quantitative approach. (2) Supply side management, which focuses on the renewable energy resource and methods of utilising it. This is decided based on thermodynamic consideration having the resource-user temperature or exergy destruction as the objective criteria. It is, therefore, a qualitative approach. The two options are explained schematically in Figure 10. The exergy-based energy, developed with supply side perspective is shown in Figure 11. The following policy measures had been identified:

- Clear environmental and social objectives for energy market liberalisation, including a commitment to energy efficiency and renewables.
- Economic, institutional and regulatory frameworks, which encourage the transition to total energy services.
- Economic measures to encourage utility investment in energy efficiency (e.g., levies on fuel bills).
- Incentives for demand side management, including grants for low-income households, expert advice and training, standards for appliances and buildings and tax incentives.
- Research and development funding for renewable energy technologies not yet commercially viable.

- Continued institutional support for new renewables (such as standard cost-reflective payments and obligation on utilities to buy).
- Ecological tax reform to internalise external environmental and social costs within energy prices.
- Planning for sensitive development and public acceptability for renewable energy.

Energy resources are needed for societal development. Their sustainable development requires a supply of energy resources that are sustainably available at a reasonable cost and can cause no negative societal impacts. Energy resources such as fossil fuels are finite and lack sustainability, while renewable energy sources are sustainable over a relatively longer term. Environmental concerns are also a major factor in sustainable development, as activities, which degrade the environment, are not sustainable. Hence, as much as environmental impact is associated with energy, sustainable development requires the use of energy resources, which cause as little environmental impact as possible. One way to reduce the resource depletion associated with cycling is to reduce the losses that accompany the transfer of exergy to consume resources by increasing the efficiency of exergy transfer between resources, i.e., increasing the fraction of exergy removed from one resource that is transferred to another [34].

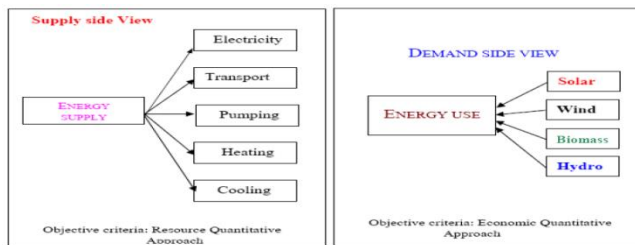

Figure 10. Supply side and demand side management approach for energy [34].

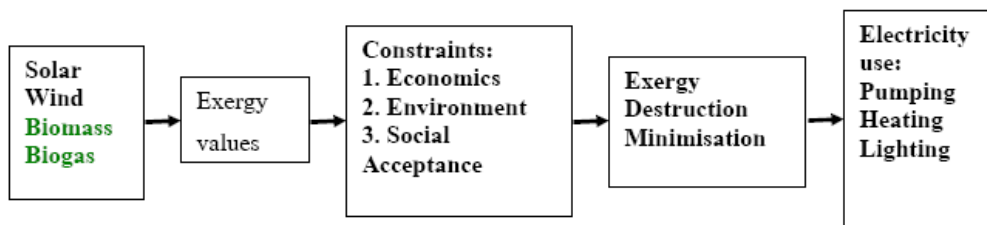

Figure 11. Exergy based optimal energy model [34].

As explained above, exergy efficiency may be thought of as a more accurate measure of energy efficiency that accounts for quantity and quality aspects of energy flows. Improved exergy efficiency leads to reduced exergy losses. Most efficiency improvements produce direct environmental benefits in two ways. First, operating energy input requirements are reduced per unit output, and pollutants generated are correspondingly reduced. Second, consideration of the entire life cycle for energy resources and technologies suggests that improved efficiency reduces environmental impact during most stages of the life cycle. Quite often, the main concept of sustainability, which often inspires local and national authorities to incorporate environmental consideration into setting up energy programmes have different meanings in different contexts though it usually embodies a long-term perspective. Future energy systems will largely be shaped by broad and powerful trends that have their roots in basic human needs. Combined with increasing world population, the need will become more apparent for successful implementation of sustainable development [35].

Heat has a lower exergy, or quality of energy, compared with work. Therefore, heat cannot be converted into work by 100% efficiency. Some examples of the difference between energy and exergy are shown in Table 17.

$$\text{Carnot Quality Factor (CQF)} = (1 - T_o / T_s) \quad (5)$$

$$\text{Exergy} = \text{Energy (transferred)} \times \text{CQF} \quad (6)$$

Where T_o is the environment temperature (K) and T_s is the temperature of the stream (K).

Table 17. Qualities of various energy sources [35]

Source	Energy (J)	Exergy (J)	CQF
Water at 80°C	100	16	0.16
Steam at 120°C	100	24	0.24
Natural gas	100	99	0.99
Electricity/work	100	100	1.00

The terms used in Table 17 have the following meanings:

Various parameters are essential to achieving sustainable development in a society. Some of them are as follows:

- Public awareness.
- Information.
- Environmental education and training.
- Innovative energy strategies.
- Renewable energy sources and cleaner technologies.
- Financing.
- Monitoring and evaluation tools.

Improving access for rural and urban low-income areas in developing countries must be through energy efficiency and renewable energies. Sustainable energy is a prerequisite for development. Energy-based living standards in developing countries, however, are clearly below standards in developed countries. Low levels of access to affordable and environmentally sound energy in both rural and urban low-income areas are therefore a predominant issue in developing countries. In recent years many programmes for development aid or technical assistance have been focusing on improving access to sustainable energy, many of them with impressive results [36].

Apart from success stories, however, experience also shows that positive appraisals of many projects evaporate after completion and vanishing of the implementation expert team. Altogether, the diffusion of sustainable technologies such as energy efficiency and renewable energies for cooking, heating, lighting, electrical appliances and building insulation in developing countries has been slow. Energy efficiency and renewable energy programmes could be more sustainable and pilot studies more effective and pulse releasing if the entire policy and implementation process was considered and redesigned from the outset. New financing and implementation processes are needed which allow reallocating financial resources and thus enabling countries themselves to achieve a sustainable energy infrastructure. The links between the energy policy framework, financing and implementation of renewable energy and energy efficiency projects have to be strengthened and capacity building efforts are required.

Results and Discussions

The presented study is general review on the potential and use of bioenergy. It highlights some assets and disadvantages of this type of energy source focusing on sustainability aspects [37-38]. Also, the following action areas for producers were recommended:

- Management and measurement tools- adopting environmental management systems appropriate for the business.
- Performance assessment tools- making use of benchmarking to identify scope for impact reduction and greater eco-efficiency in all aspects of the business.
- Best practice tools- making use of free help and advice from government best practice programmes (energy efficiency, environmental technology, and resource savings).
- Innovation and ecodesign- rethinking the delivery of ‘value added’ by the business, so that impact reduction and resource efficiency are firmly built in at the design stage.
- Cleaner, leaner production processes- pursuing improvements and savings in waste minimisation, energy and water consumption, transport and distribution, as well as reduced emissions.
- Supply chain management- specifying more demanding standards of sustainability from ‘upstream’ suppliers, while supporting smaller firms to meet those higher standards.
- Product stewardship- taking the broadest view of ‘producer responsibility’ and working to reduce all the ‘downstream’ effects of products after they have been sold on to customers.
- Openness and transparency- publicly reporting on environmental performance against meaningful targets; actively using clear labels and declarations so that customers are fully informed; building stakeholder confidence by communicating sustainability aims to the workforce, the shareholders and the local community

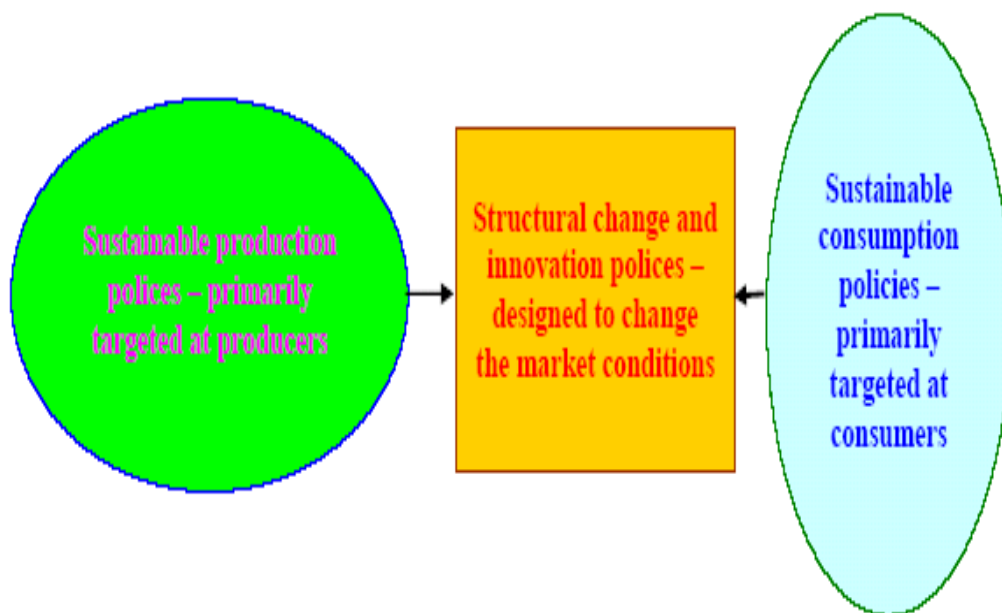

(Figure 12).

Figure 12. Link between resources and productivity [39].

Table 18. The basket of indicators for sustainable consumption and production [39]

Economy-wide decoupling indicators

1. Greenhouse gas emissions
2. Air pollution
3. Water pollution (river water quality)
4. Commercial and industrial waste arisings and household waste not cycled

Resource use indicators

5. Material use
6. Water abstraction
7. Homes built on land not previously developed, and number of households

Decoupling indicators for specific sectors

8. Emissions from electricity generation
9. Motor vehicle kilometres and related emissions
10. Agricultural output, fertiliser use, methane emissions and farmland bird populations
11. Manufacturing output, energy consumption and related emissions
12. Household consumption, expenditure energy, water consumption and waste generated

Alternatively energy sources can potentially help fulfill the acute energy demand and sustain economic growth in many regions of the world. Bioenergy is beginning to gain importance in the global fight to prevent climate change. The scope for exploiting organic waste as a source of energy is not limited to direct incineration or burning refuse-derived fuels. Biogas, biofuels and woody biomass are other forms of energy sources that can be derived from organic waste materials. These biomass energy sources have significant potential in the fight against climate change. Recently, there are many studies on modern biomass energy technology systems published [40].

This is the step in a long journey to encourage a progressive economy, which continues to provide people with high living standards, but at the same time helps reduce pollution, waste mountains, other environmental degradation, and environmental rationale for future policy-making and intervention to improve market mechanisms. This vision will be accomplished by:

3rd International Conference on “Global Initiative in Agricultural, Forestry and Applied Sciences for Food Security, Environmental Safety and Sustainable Development (GIAFAS-2021)”

- ‘Decoupling’ economic growth and environmental degradation. The basket of indicators illustrated shows the progress being made (Table 18). Decoupling air and water pollution from growth, making good headway with CO₂ emissions from energy, and transport. The environmental impact of our own individual behaviour is more closely linked to consumption expenditure than the economy as a whole.
- Focusing policy on the most important environmental impacts associated with the use of particular resources, rather than on the total level of all resource use.
- Increasing the productivity of material and energy use that are economically efficient by encouraging patterns of supply and demand, which are more efficient in the use of natural resources. The aim is to promote innovation and competitiveness. Investment in areas like energy efficiency, water efficiency and waste minimisation.
- Encouraging and enabling active and informed individual and corporate consumers.

Vegetation and in particular forests, can be managed to sequester carbon. Management options have been identified to conserve and sequester up to 90 Pg C in the forest sector in the next century, through global afforestation [41]. For efficient use of bioenergy resources, it is essential to take account of the intrinsic energy potential. Despite the availability of basic statistics, many differences have been observed between the previous assessments of bioenergy potential [41].

On some climate change issues (such as global warming), there is no disagreement among the scientists. The greenhouse effect is unquestionably real; it is essential for life on earth. Water vapour is the most important GHG; followed by carbon dioxide (CO₂). Without a natural greenhouse effect, scientists estimate that the earth’s average temperature would be –18°C instead of its present 14°C [41]. There is also no scientific debate over the fact that human activity has increased the concentration of the GHGs in the atmosphere (especially CO₂ from combustion of coal, oil and gas). The greenhouse effect is also being amplified by increased concentrations of other gases, such as methane, nitrous oxide, and CFCs as a result of human emissions. Most scientists predict that rising global temperatures will raise the sea level and increase the frequency of intense rain or snowstorms (Andrea, and Fernando, 2012).

Globally, buildings are responsible for approximately 40% of the total world annual energy consumption. Most of this energy is for the provision of lighting, heating, cooling, and air conditioning. Increasing awareness of the environmental impact of CO₂, NO_x and CFCs emissions triggered a renewed interest in environmentally friendly cooling, and heating technologies. Under the 1997 Montreal Protocol, governments agreed to phase out chemicals used as refrigerants that have the potential to destroy stratospheric ozone. It was therefore considered desirable to reduce energy consumption and decrease the rate of depletion of world energy reserves and pollution of the environment. One way of reducing building energy consumption is to design buildings, which are more economical in their use of energy for heating, lighting, cooling, ventilation and hot water supply. Passive measures, particularly natural or hybrid ventilation rather than air-conditioning, can dramatically reduce primary energy consumption. However, exploitation of renewable energy in buildings and agricultural greenhouses can, also, significantly contribute towards reducing dependency on fossil fuels. Therefore, promoting innovative renewable applications and reinforcing the renewable energy market will contribute to preservation of the ecosystem by reducing emissions at local and global levels [42].

The adoption of green or sustainable approaches to the way in which society is run is seen as an important strategy in finding a solution to the energy problem. The key factors to reducing and controlling CO₂, which is the major contributor to global warming, are the use of alternative approaches to energy generation and the exploration of how these alternatives are used today and may be used in the future as green energy sources. Even with modest assumptions about the availability of land, comprehensive fuel-wood farming programmes offer significant energy, economic and environmental benefits. These benefits would be dispersed in rural areas where they are greatly needed and can serve as linkages for further rural economic development. The

3rd International Conference on “Global Initiative in Agricultural, Forestry and Applied Sciences for Food Security, Environmental Safety and Sustainable Development (GIAFAS-2021)”

nations as a whole would benefit from savings in foreign exchange, improved energy security, and socio-economic improvements. With a nine-fold increase in forest – plantation cover, a nation’s resource base would be greatly improved. The international community would benefit from pollution reduction, climate mitigation, and the increased trading opportunities that arise from new income sources.

Conclusion

Even with modest assumptions about the availability of land, comprehensive fuel-wood farming programmes offer significant energy, economic and environmental benefits. These benefits would be dispersed in rural areas where they are greatly needed and can serve as linkages for further rural economic development. The nations, as a whole would benefit from savings in foreign exchange, improved energy security, and socio-economic improvements. With a nine-fold increase in forest – plantation cover, the nation’s resource base would be greatly improved. The international community would benefit from pollution reduction, climate mitigation, and the increased trading opportunities that arise from new income sources. Furthermore, investigating the potential is needed to make use of more and more of its waste. Household waste, vegetable market waste, and waste from the cotton stalks, leather, and pulp; and paper industries can be used to produce useful energy either by direct incineration, gasification, digestion (biogas production), fermentation, or cogeneration. Therefore, effort has to be made to reduce fossil energy use and to promote green energies, particularly in the building sector. Energy use reductions can be achieved by minimising the energy demand, by rational energy use, by recovering heat and the use of more green energies. This study was a step towards achieving that goal.

Acknowledgments

The financial support for this research work from the Energy Research Institute is gratefully acknowledged. I am grateful to my wife Kawthar Abdelhai Ali for standing beside me.

References

- [1] Abdeen M. O. (2015). Utilisation of biomass for renewable bioenergy development, *International Journal of Comprehensive Research in Biological Science*, Vol.2, No.1, p. 1-28, India, January 2015.
- [2] Abdeen, M. O. (2008a). Renewable building energy systems and passive human comfort solutions. *Renewable and Sustainable Energy Reviews*, 12(6), 1562-1587.
- [2] Abdeen, M. O. (2008b). People, power and pollution. *Renewable and Sustainable Energy Reviews*, 12(7), 1864-1889.
- [4] Abdeen, M. O. (2008c). Energy, environment and sustainable development. *Renewable and Sustainable Energy Reviews*, 12(9), 2265-2300.
- [5] Abdeen, M. O. (2008d). Focus on low carbon technologies: The positive solution. *Renewable and Sustainable Energy Reviews*, 12(9), 2331-2357.
- [6] Abdeen, M. O. (2008e). Chapter 10: Development of integrated bioenergy for improvement of quality of life of poor people in developing countries. In F. L. Magnusson & O. W. Bengtsson (Eds.), *Energy in Europe: Economics, policy and strategy* (pp. 341-373). New York, NY: NOVA Science Publishers.
- [7] Abdeen, M. O. (2009a). Environmental and socio-economic aspect of possible development in renewable energy use. In *Proceedings of the 4th International Symposium on Environment*, Athens, Greece, 21-24 May 2009.
- [8] Abdeen, M. O. (2009b). Energy use, environment and sustainable development. In *Proceedings of the 3rd International Conference on Sustainable Energy and Environmental Protection (SEEP 2009)*, Paper No.1011, Dublin, Republic of Ireland, 12-15 August 2009.
- [9] Abdeen, M. O. (2009c). Energy use and environmental: Impacts: A general review. *Journal of Renewable and Sustainable Energy*, 1(5), 1-29.
- [10] Abdeen, M. O. (2009d). Chapter 3: Energy use, environment and sustainable development. In R. T. Mancuso (Ed.), *Environmental cost management*, (pp. 129-166). New York, NY: NOVA Science Publishers.
- [11] Aladjadjian, A., and Kakanakov, R. (2008). The role of RES in future power supply of Bulgaria. 7th Balkan Power Conference, Sibenik, Croatia, 10-12 September 2008, Proceedings, ISBN 987-243-091-7, Published by University of Ljubljana, Ed. Andrej Gubina.

3rd International Conference on “Global Initiative in Agricultural, Forestry and Applied Sciences for Food Security, Environmental Safety and Sustainable Development (GIAFAS-2021)”

- [12] Aladjadjiyan, A., Kakanakov, R. and Zahariev, A. (2010). Biomass energy resources in estimation and sustainable incorporation of biomass and other RES in municipal and national strategies for energy development, *Scopie*, 4.10.2010. Proceedings, pp 88-95.
- [13] Aleksandar Z., Dimo, P., Anna, A. (2014). Biogas from animal manure-perspectives and barriers in Bulgaria, *Annual Research and Review in Biology*, 4(5): 709-719.
- [14] Andrea, S., and Fernando, R. (2012). Identifying, developing, and moving sustainable communities through renewable energy, *World Journal of Science, Technology and Sustainable Development*, 9(4): 273-281.
- [15] Aroyeun, S. O. (2009). Reduction of aflatoxin B1 and Ochratoxin A in cocoa beans infected with *Aspergillus* via Ergosterol Value. *World Review of Science, Technology and Sustainable Development*, 6(1), 75-90.
- [16] Bacaoui, A., Yaacoubi, A., Dahbi, C., Bennouna, J., and Mazet, A. (1998). Activated carbon production from Moroccan olive wastes-influence of some factors. *Environmental Technology* 19: 1203-1212.
- [17] Barton A. L. (2007). *Focus on sustainable development research advances*, (pp. 189-205). New York, NY: NOVA Science Publishers, Inc.
- [18] Bessou, S. (2009). Biofuels, greenhouse gases and climate change. *Agronomy for Sustainable Development*, DOI: 10.1051/agro/2009039.
- [19] Bhutto A, Bazmi A, Zahwdi G (2011) Greener energy: issues and challenges for Pakistan – Biomass energy prospective. *Renewable and Sustainable Energy Reviews*, 15 (6): 3207-32-19.
- [20] Brain, G., & Mark, S. (2007). Garbage in, energy out: Landfill gas opportunities for CHP projects. *Cogeneration and On-Site Power*, 8(5), 37-45.
- [21] Cheng, R. (2010). Advanced biofuel technologies: status and barriers. World Bank Report, WPS5411.
- [22] Cihan G, Dursun B, Bora A, Erkan S (2009) Importance of biomass energy as alternative to other sources in Turkey. *Energy Policy*, 37 (2): 424-431.
- [23] D’Apote, S.L. (1998). IEA biomass energy analysis and projections. In: *Proceedings of Biomass Energy Conference: Data, analysis and Trends*, Paris: OECD; 23-24 March 1998.
- [24] Duku, B. (2009). Comprehensive review of biomass resources and biofuels potential in Ghana. *Renewable and Sustainable Energy Review*, 15: 404-415.
- [25] Erlich, P. (1991). Forward facing up to climate change, in *Global Climate Change and Life on Earth*. R.C. Wyman (Ed), Chapman and Hall, London.
- [26] Hall O. and Scrase J. (1998). Will biomass be the environmentally friendly fuel of the future? *Biomass and Bioenergy* 15: 357-67.
- [27] Jeremy, L. (2005). The energy crisis, global warming and the role of renewables. *Renewable Energy World*, 8(2).
- [28] Kothari, D. P., Singal, K. C., Rakesh, Ranjan (2011). *Renewable energy sources and emerging technologies*, 2nd Edition, Private Ltd, New Delhi, 2011.
- [29] Lattimore, B. (2009). Environmental factors in woodfuel production- opportunities, risks, and criteria and indicators for sustainable practices, *Biomass and Bioenergy*, 33: 1321-1342.
- [30] Levine, M., & Hirose, M. (2005). *Energy efficiency improvement utilising high technology: An assessment of energy use in industry and buildings*. Report and Case Studies. London, UK: World Energy Council.
- [31] Omer, A.M. (2006). Review: Organic waste treatment for power production and energy supply. *Cells and Animal Biology* 1 (2): 34-47.
- [32] Omer, A.M. (2007). Renewable energy resources for electricity generation in Sudan. *Renewable and Sustainable Energy Reviews* 11: 1481-1497.
- [33] Omer, A.M. (2008). Green energies and environment. *Renewable and Sustainable Energy Reviews* 12: 1789-1821.
- [34] Omer, A.M., Yemen, F. (2003). Biogas energy technology in Sudan. *Renewable Energy*, 28 (3): 499-507.
- [35] Pernille, M. (2004). Feature: Danish lessons on district heating. *Energy Resource Sustainable Management and Environmental March/April 2004*: 16-17.
- [36] Robinson, G. (2007). Changes in construction waste management. *Waste Management World*, pp. 43-49. May-June 2007.
- [37] Rossi, S., Arnone, S., Lai, A., Lapenta, E., and Sonnino, A. (1990). ENEA’s activities for developing new crops for energy and industry. In: *Biomass for Energy and Industry* (G. Grassi, G. Gosse, G. dos Santos Eds.). Vol.1, pp.107-113, Elsevier Applied Science, London and New York.
- [38] Rural Industries Research and Development Corporation (RIRDC). (2009). Sustainability production of bioenergy: a review of global bioenergy sustainability frameworks and assessment systems.
- [39] Sims, R.H. (2007). Not too late: IPCC identifies renewable energy as a key measure to limit climate change. *Renewable Energy World* 10 (4): 31-39.
- [40] Singh, A. (2008). Biomass conversion to energy in India: a critique. *Renewable and Sustainable Energy Review*, 14: 1367-1378.

- [41] Wu, J. and Boggess, W. (1999). The optimal allocation of conservation funds. *Journal Environmental Economic Management*. 1999: 38.
- [42] Zahariev, A., Kostadinova, Sv., and Aladjadjiyan, A. (2014). Composting municipal waste for soil re-cultivation in Bulgaria, *International Journal of Plant and Soil Science*, 3(2): 178-185.

The role of plant growth promoting rhizobacteria in the management of disease complex induced by root knot nematode and fusarium wilt fungus

Zakaullah Khan*, Bharat H. Gawade and V Celia Chalam

Division of Plant Quarantine, ICAR-National Bureau of Plant Genetic Resources, New Delhi

Introduction: Root-knot nematodes (RKN), *Meloidogyne* spp. are among the most damaging nematodes in agriculture, causing an estimated US\$100 billion loss/year worldwide. They are most spread nematodes, found wherever plants are grown and any agricultural crop may be a host to one or more species of RKN. They are sedentary endoparasites of roots, attacking a wide range of crops worldwide. The infection starts with root penetration of second stage juveniles (J2) hatched in soil from eggs encapsulated in egg masses laid by females on the infected roots. *Meloidogyne* species cause heavy galls in roots of many crops. Besides, causing direct damage to host plant, RKN also act as predisposing and facilitating agent for the entry of other soil borne pathogens, fungi and bacteria, which often damage plants more severely and render the disease control more difficult than single pathogens alone. Use of chemical nematicides was one of the primary means for controlling plant-parasitic nematodes, including RKN. However, their potential negative impact on the environment and human health has led to a total ban or restricted use of most nematicides. However, because of concern about the quality of the environment and food in recent years, there have been worldwide efforts for the use of eco-friendly methods, which are bio-efficacious, economical, biodegradable and environmentally safe and could be ideal candidates for use as a reliable tool to control plant diseases. The use of micro-organisms to manage plant diseases offers an attractive to the use of synthetic chemicals. Reports have suggested that *Paenibacillus polymyxa* produces many antagonistic substances and controls several soil and foliar pathogens in greenhouses and fields (Mavingui and Heulin 1994; Haggag 2007; Haggag and Timmusk 2008; Khan et al. 2008; Kim et al. 2009; Son et al. 2007, 2009). The purpose of this study was to screen and evaluate antifungal and nematicidal activities of *Paenibacillus* strains and to evaluate biocontrol potential of selected strains against disease complex caused by *M. incognita* and *F. oxysporum* f. sp. *lycopersici* interactions.

Keywords: *Fusarium oxysporum* f. sp. *lycopersici*, interaction, management, *Meloidogyne incognita*, *Paenibacillus*, rhizobacteria.

Materials and methods: The interaction of *M. incognita* and *F. oxysporum* f. sp. *lycopersici* was determined under the greenhouse conditions. Three-week-old tomato seedlings were planted into pots. Each plant was inoculated with *F. oxysporum* f. sp. *lycopersici* and/or J2 of *M. incognita*. About 7 weeks after fungus and/or nematode inoculation, plants were carefully uprooted from pots and wilt severity was graded using a 0–5 scale. *In vitro* experiments were conducted to screen 40 strains of *P. polymyxa* and *P. lentimorbus* for their antifungal and nematicidal activity against *F. oxysporum* f. sp. *lycopersici* and *Meloidogyne incognita*, respectively. As *in vitro* assays indicated that among the tested strains, *P. polymyxa* GBR-462, GBR-508 and *P. lentimorbus* GBR-158 had the highest inhibitory activity against *F. oxysporum* f. sp. *lycopersici* and *M. incognita*, these strains were used for biocontrol of disease complex caused by *F. oxysporum* f. sp. *lycopersici* and *M. incognita* on tomato plants in potted soil. The culture of these strains grown in BHI broth for 2 days were added to potting soil around the plant roots at the rate of 5 ml per pot (10^8 CFU ml⁻¹) separately to determine their biocontrol efficacies. Plants grown in untreated soil served as control.

Results and discussion: The synergistic effect of *M. incognita* was confirmed in fusarium wilts of tomato caused by *Fusarium oxysporum* f. sp. *lycopersici* by comparing disease severity (wilting and plant death) between single and concomitant inoculation of nematode and fungal pathogens. In *in vitro* experiments, among 40 tested strains of *Paenibacillus* spp., 11 strains showed antifungal and nematicidal activities against *F. oxysporum* f. sp. *lycopersici* and *M. incognita*, respectively. Among them three strains, *Paenibacillus polymyxa* GBR-462; GBR-508 and *P. lentimorbus* GBR-158 showed the strongest antifungal and nematicidal activities. These three strains used in pot experiment to evaluate their biocontrol potential. Wilt severity of Fusarium wilt-root-knot nematode disease complex in the pot experiments were significantly reduced by the treatments of *P. polymyxa* GBR-508, GBR-462 and *P. lentimorbus* GBR-158, of which the control effects were estimated as 90–98%, and also reduced root-gall formation by 64–88% compared to the untreated control. Shoot and root growths of tomato plants were reduced significantly ($P \leq 0.05$) by the infection of both pathogens; however, treatments of these bacterial strains enhanced plant growths, especially showing more shoot growth than uninoculated healthy plants. Bacterial antibiotics and other compounds present in cultural metabolites might be responsible for J2 mortality and inhibition of egg hatch and fungal growth. *Paenibacillus* strains produce antimicrobial substances active against fungi, bacteria and nematodes (Kajimura and Kaneda 1996; Von der Weid et al. 2003; Son et al. 2007, 2009). The pot experiments indicated that addition of *Paenibacillus* strains into potted soil suppressed the Fusarium wilt severity and root galling on tomato and increased plant growth. The reduction of the disease complex may be attributed to direct effects of metabolites that inhibit hyphal growth and egg hatch and induce mortality in J2, or that may have also enhanced host defense mechanism in roots that reduces invasion and consequent infection by pathogens and inhibition of giant cell formation.

Conclusion: The studies revealed that the tested strains of *Paenibacillus* species had no adverse effect on plants but promoted their growth. Thus, the protective and nutritional properties of *Paenibacillus* strains make them as environmentally friendly useful tool to reduce deleterious impact of disease complex caused by root-knot nematode and fusarium wilt on plant growth, especially in organic farming system, where plant nutrition and disease control are the main limiting factor.

References

- Haggag, W.M. (2007). Colonization of exopolysaccharide producing *Paenibacillus polymyxa* on peanut roots for enhancing resistance against crown rot disease. *Afr J Biotechnol* 6: 1568-1577.
- Haggag, W.M. and Timmusk, S. (2008). Colonization of peanut roots by biofilm-forming *Paenibacillus polymyxa* initiates biocontrol against crown rot disease. *J Appl Microbiol* 104: 961-969.
- Kajimura, Y. and Kaneda, M. (1996). Fusaricidin A, a new depsipeptide antibiotic produced by *Bacillus polymyxa* KT-8 taxonomy, fermentation, isolation, structure elucidation and biological activity. *J Antibiot* 49: 129-135.
- Khan, Z., Kim, S.G, Jeon, Y.H., Khan, H.U., Son, S.H. and Kim, Y.H. (2008). A plant growth promoting rhizobacterium, *Paenibacillus polymyxa* strain GBR-1, suppresses root-knot nematode. *Biores Technol* 99: 3016-3023.

3rd International Conference on “Global Initiative in Agricultural, Forestry and Applied Sciences for Food Security, Environmental Safety and Sustainable Development (GIAFAS-2021)”

- Kim, S.G, Khan, Z., Jeon, Y.H. and Kim, Y.H. (2009). Inhibitory effect of *Paenibacillus polymyxa* GBR-462 on *Phytophthora capsici* causing *Phytophthora* blight in chili pepper. *J Phytopathol* 157: 329-337.
- Mavingui, P. and Heulin, T. (1994). *In vitro* chitinase and antifungal activity of a soil, rhizosphere and rhizoplane population of *Bacillus polymyxa*. *Soil Biol Biochem* 26, 801-803.
- Son SH, Khan Z, Kim SG and Kim YH (2009). Plant growth-promoting rhizobacteria, *Paenibacillus polymyxa* and *P. lentimorbus* suppress disease complex caused by root-knot nematode and fusarium wilt fungus. *J Appl Microbiol* 107: 524-532.
- Son, S.H., Khan, Z., Moon, H.S., Kim, S.G., Choi, D.R. and Kim, Y.H. (2007). Nematicidal Activity of a plant growth promoting rhizobacterium, *Paenibacillus polymyxa*. *Russian J Nematol* 15: 95-100.

Land potentiality evaluation based on GIS modeling technique for Agroforestry uses in the Jharkhand state of India

Firoz Ahmad^{1*}, Abdul Majid Ansari², Firoz Ahmad³, Laxmi Goparaju¹

¹*Vindhyan Ecology and Natural History Foundation, Mirzapur, Uttar Pradesh, India.*

²*Zonal Research Station (Birsa Agricultural University, Ranchi), Chianki, Palamau, Jharkhand, India*

³*Faculty of Forestry, Birsa Agricultural University, Ranchi, Jharkhand, India*

ABSTRACT

Magnifying the agroforestry area in various formats as per landscape potentiality is the scientific path towards achieving various Sustainable Development Goals especially improving livelihood, reducing poverty, conserving the environment and biodiversity.

In the present study, the attempt was made to examine the land potentially in the state of Jharkhand for enhancing the uses for agroforestry utilizing the GIS modeling approach with dataset linked to climate, topography, ecology, and socio-economy.

The analysis highlights the five districts of the state have a mean agroforestry value greater than 60%. The highest (78.2%) was found in Simdega followed by Pakaur (72.5%) Dumka (68.8%) Sahibganj (64.6%) and Godda (63.4%).

The study concludes that geospatial technology has a greater role in identifying the land capability for agroforestry uses in the diversified domain. Such approach/result needs to be incorporated which will guide the nodal authorities to prepare appropriate strategies for district-level landscapes planning and management.

Morpho-Physiological and Biochemical Performances of Different Sugarbeet Genotypes under Salinity Stress

Abdul Awal Chowdhury Masud^δ, Naznin Ahmed, Md. Rakib Hossain Raihan, Mirza Hasanuzzaman*

Department of Agronomy, Sher-e-Bangla Agricultural University, Dhaka-1207, Bangladesh

Purpose

Sugarbeet (*Beta vulgaris* L.) is a short-duration and moderately saline tolerant crop. Salinity is a major threat for crop productivity in southern coastal regions of Bangladesh. So, increasing sugarbeet cultivation area in coastal saline soil would be a better prospect to minimize the gap between sugar consumption and production in the country. We focused to explore the morpho-physiological and biochemical responses of eight sugarbeet genotypes under salt stress condition.

Methods

A total of 8 genotypes (HI-0473, HI-0044, BSRI Sugarbeet-1, KWS-Serendara, BSRI Sugarbeet-2, KSW-Danica, KWS-Allanya, and KWS-Gregasia) were considered for this study. Stressed plants were irrigated with 100 mM NaCl. Data were collected after the stress period was over. The entire experiment was repeated three times.

Results

Salt stress greatly impaired the plant physiological performances compared to the control. Physiological attributes like, relative water content, SPAD value were reduced under stress condition. In addition, root-shoot length, fresh and dry weight were significantly impacted by salinity. Biochemical stress markers malondialdehyde (MDA), H₂O₂ and electrolyte leakage were increased both in root and leaf in all genotypes under saline condition. However, based on growth pattern and physiological performances, the highest were observed in the HI-0044 genotype followed by HI-0473, while KWS-Allanya and KWS-Serenada were resulted with significant damages under salinity stress. Results also showed that among eight sugarbeet genotypes under 100 mM salt treatments, HI-0044 genotype performed better in accumulating higher percentages of total soluble solids (TSS%).

Conclusion

Salinity greatly impacted the normal physiology of the plant. However, HI-0044 was observed with better performances under salinity stress followed by HI-0473 and BSRI Sugarbeet-1 whereas, KWS-Serendara and KWS-Allanya showed worst performances in terms of morpho-physiological and biochemical attributes.

Keywords: Sugarbeet, Salinity, Genotypes, Total soluble solids, Relative water content, SPAD value.

The role of mycorrhiza in food security and challenge with climate change

Dr. İbrahim Ortaş

University of Cukurova, Faculty of Agriculture, Department of Soil Science, and Plant Nutrition, Adana, Turkey.

Purpose

After the industrial revolution, the increasing use of fossil fuels started to increase the concentration of CO₂ in the atmosphere from 280 ppm to present time 414 ppm. Meanwhile, increasing population growth (around 8 billion) has also started to put serious pressure on soil ecosystem for more food production demand. With the demand for more food production, intensive chemical inputs and soil cultivation practices applied to the soil has increased the amount of CO₂ released to the atmosphere. Increasing CO₂ concentration in the atmosphere triggers global warming and climate change. Global climate changes negatively affect plant growth and consequently food security. There is a need to re-manage the natural mechanisms to ensure climate change control and food security. In this context, it is aimed to reduce the effect of climate changes by keeping more carbon as a sink by operating the effects of plant root mechanisms on the soil health according to ecological principles. Under long term field conditions the effects of different soil-plant managements, especially mycorrhiza fungi, were investigated.

Methods

Since 1996, several researches have been carried out under long-term field studies to see the effect of mycorrhizal fungi and other microorganisms on carbon sequestration, as well as the emission of CO₂ from the greenhouse gases to the atmosphere. CO₂ emissions, photosynthesis and total carbon and nitrogen sequestration and yields are measured regularly. Data are yearly evaluated.

Results

Research findings showed that under field conditions organic fertilizer and mycorrhizal fungi applications sequestered more carbon. It has been calculated that the use of animal manure, compost, biochar, and mycorrhizal fungi significantly keep more carbon. It is determined that there is an increase of 1.5 ppm CO₂ concentration in atmosphere per year. It has been determined that especially long-term addition of organic matter and management of natural mycorrhizae increase soil organic carbon and accordingly soil quality and productivity increase.

Conclusions

Since effect of climate change and high population have negative effects on food security definitely there is a new agriculture revelation to overcome of climate and food security problem. Soil and plant management must be managed according to low-input ecological principles.

Key words: Greenhouse gasses, Climate changes, Soil organic carbon, Soil-crop management, food security, mycorrhizal management

Protective Role of Biochar and Chitosan Biopolymer in Enhancing Salt Tolerance in *Corchorus olitorius*

Md. Rakib Hossain Raihan^δ and Mirza Hasanuzzaman*

Department of Agronomy, Sher-e-Bangla Agricultural University, Dhaka-1207, Bangladesh

Purpose

Biochar is a carbon rich organic amendment and chitosan is a deacetylated product of chitin which have potential role to mitigate the salt stress. Though several studies have been conducted to evaluate the individual role of biochar and chitosan in different crops under different stresses, but the role of these organic amendments in jute under salinity has not been studied yet. Therefore, a pot experiment has been conducted to explore the role of biochar and chitosan in mitigating salt stress in jute plants.

Methods

A tossa jute variety (*Corchorus olitorius* cv. O-9897) was exposed to three different doses of NaCl (50, 100 and 150 mM) at 20 days old seedlings. Biochar was pre-mixed with the soil at the rate of 2 g kg⁻¹ soil and chitosan-100 was applied through irrigation at the rate of 100 mg L⁻¹ for two times.

Results

Upon exposure to salt stress, lipid peroxidation, content of hydrogen peroxide and superoxide radicals, lipoxygenase activity, electrolyte leakage and methylglyoxal content were increased notably thus causes oxidative damages in jute plants. Hence, reduced growth, biomass accumulation, and disrupts water balance were found under salt stress. A profound increase of proline content was observed in the salt stressed plants. However, supplementation with biochar and chitosan have significantly mitigated the deleterious effect of ROS-induced damages in jute through stimulating both non-enzymatic (e.g., ascorbate and glutathione) and enzymatic (e.g., ascorbate peroxidase, dehydroascorbate reductase, monodehydroascorbate reductase, glutathione reductase superoxide dismutase, catalase, peroxidase, glutathione *S*-transferase, glutathione peroxidase) antioxidant activities, enhancing glyoxalase enzyme activities (glyoxalase I and glyoxalase II) ameliorates ROS toxicity, and increases oxidative stress tolerance thus improves growth and physiology of jute plants. Besides, Na⁺ toxicity significantly reduced with biochar and chitosan supplementation, thus decreased Na⁺/K⁺ ratio in plants upon imposition to salt stress.

Conclusions

The current study depicts the exclusive role of biochar and chitosan in protecting the plants from salt-induced damages in jute. However, based on the findings it could be suggested that biochar performed better against salt stress than chitosan.

Keywords: Abiotic stress, Salinity, Tossa jute, Antioxidant defense, Biochar, Chitosan, Organic amendments.

Implication of melatonin on photosynthesis, photosystem, fast chlorophyll fluorescence and related gene expression in tomato seedling under high temperature stress

Mohammad Shah Jahan

College of Horticulture, Nanjing Agricultural University, P. R. China

Purpose

Photosynthesis is a fundamental manufacturing technique in plants that can enhance carbon absorption and increase crop productivity. Heat stress severely inhibits photosynthetic efficiency. Melatonin has established as a ubiquitous phytohormone capable of regulating diverse abiotic stress tolerance. However, the underlying mechanisms by which melatonin stimulates the photosynthesis capacity and the understanding of melatonin-mediated photosynthesis in plants exposed to heat stress largely remains to unravel. Here, we unveiled the putative functions of melatonin (100 μ M) in the regulation of photosynthesis under heat stress (42 °C for 24 h) in tomato.

Key words: melatonin, high temperature, photosynthesis, photosystem I and II, CO₂ assimilation, tomato

Methods

In the present experiment tomato (*Solanum lycopersicum*) seedlings were used as the test material. Uniform size tomato seeds were germinated on moistened filter paper and then germinated seeds were sown in growing media that composed of vermiculite and perlite in growth chamber. At the second true leaves stage, seedlings were transplanted in new plastic pots (250 cm³) and ½ strength Hoagland nutrient solution was incorporated with irrigation water. When the seedlings attained the fourth leaf stage, half of the seedlings were foliar sprayed with melatonin at a concentration of 100 μ M every two days and continued for seven (7) days, while the other half of the seedlings were hydrosprayed with distilled water. One week after treatments, melatonin and water-treated seedlings were subjected to high-temperature stress at 42°C (16/8 h) for 1 day.

Results

Our results revealed that melatonin treatment increased/enhanced the endogenous melatonin content along with its biosynthesis gene expression resulted in elevated chlorophyll content and their biosynthesis transcripts abundance under high temperature stress, whereas heat stress significantly inhibited the content of gas exchange parameters. Under heat stress, melatonin boosted the CO₂ assimilation i.e. V_{c,max} (maximum rate of Rubisco), and J_{max} (electron transport of Rubisco generation). Moreover, melatonin application increased the rubisco and FBPase activity resulted in upregulated the transcripts of photosynthetic related genes expression under the same stress conditions. In addition, heat stress profoundly reduced the photochemistry properties of photosystem II (PSII) and photosystem I (PSI) particularly the maximum quantum efficiency of PSII (F_v/F_m) and PSI (P_m). Conversely, supplementation with melatonin significantly elevated the chlorophyll a fluorescence parameter. Heat stress decreased the actual PSII efficiency (Φ PSII), electron transport rate (ETR) and photochemical quenching coefficient (qP), while increasing non-photochemical quenching (NPQ), however, melatonin reversed these value which helps to protect the photosynthetic apparatus resulted in dissipating excess citation energy. These findings indicated that melatonin protected the PSII and PSI reaction center and increased the electron transport efficiency.

Conclusions

Taken together, our results insight a profound knowledge of understanding on melatonin-mediated photosynthesis efficacy in a high temperature regime.

Knowledge about Sustainable Forest Management Practices of Joint Forest Management Committee Members and Non-members.

Shobha Nagnur and Akshata Ramannanavar*

Department of Extension and Communication Management, University of Agricultural Sciences, Dharwad 580 005, Karnataka, India

ABSTRACT

In recent times there is a major shift of managing forests from the Government and center based agencies towards a decentralized and people oriented forestry. In such an approach it is imperative to involve the local and indigenous communities who are dependent on forests for their livelihoods. Joint Forest Management (JFM) is an approach and programme initiated in the context of the National Forest Policy (1988), wherein the state forest department support local forest dwellers to protect and manage forests and share the costs and benefits of the forest produce and products. The present study on sustainable forest management practices has been taken up with the specific objective to study the knowledge of Joint Forest Management Committee (JFMC) members and non-members about sustainable forest management practices.

Material and Methods

The present study was conducted in the Western ghats region of Uttar Kannada district of Northern Karnataka. This district was purposively selected as it has abundant natural resources with forests covering 80% of the total geographical area. Stratified random sampling technique was used to collect data from three forest regions viz., Coastal region (96), Upphat region (252) and Plain region (116). The total sample of 464 respondents consisted of 232 Village Forest Committee also know as Joint Forest Management Committee (JFMC) members and 232 non-members. Data was collected with a structured interview schedule by personal interview, informal discussion and focused group discussions. The collected data was analyzed using frequencies and percentages.

Results and Discussion

The various components of sustainable forest management and the knowledge of the respondents as shown in table -1

Table 1: Knowledge of JFMC and non JFMC members about sustainable forest management practices

SN	Particulars	JFMC Members		Non JFMC members	
		Frequency	Percentage	Frequency	Percentage
1	Environmental awareness programmes	232	100.00	195	84.05

3rd International Conference on “Global Initiative in Agricultural, Forestry and Applied Sciences for Food Security, Environmental Safety and Sustainable Development (GIAFAS-2021)”

2	Plantation Management	232	100.00	82	35.34
3	Fire management	232	100.00	38	16.37
4	Biodiversity conservation	232	100.00	81	34.91
5	Soil and moisture conservation	232	100.00	32	13.79
6	Deforestation and land degradation	232	100.00	93	40.08
7	Conservation of NTFPs	89	38.36	-	-
8	Sustainable harvesting techniques of non timber forest products (NTFPs)	89	38.36	-	-

Table 1 shows that cent per cent of the JFMC members had knowledge about environmental awareness programme, plantation management, fire management, biodiversity conservation, soil and moisture conservation and deforestation and land degradation. While only 38.36 per cent each had knowledge about conservation of NTFPs and sustainable harvesting techniques of non timber forest products (NTFPs). In case of Non-JFMC members 84.05 per cent were knowing about environmental awareness programmes. About 40 per cent had knowledge of de forestation & land degradation. About 35.00 per cent each had knowledge of plantation management and biodiversity conservation. A lesser per cent of 16.37 and 13.79 had knowledge about fire management and soil & moisture conservation respectively. None of the non members had knowledge about NTFPs and their conservation. It was therefore evident that members regularly involved in the activities of the village forest committees had better knowledge than non-JFMC members.

Conclusion

The study brings to fore that the non-JFMC members living in forest areas need to be sensitized about sustainable forest management practices. This could be done by awareness programmes, and trainings by coordinating the efforts of different development departments.

ENTOMOPATHOGENIC NEMATODES EMERGING AS POTENT BIOCONTROL AGENT AGAINST INSECT PESTS

RASHID PERVEZ

Division of Nematology, ICAR-Indian Agricultural Research Institute, New Delhi-110 012

ABSTRACT

Entomopathogenic nematodes (EPNs) are potent biocontrol agent against various insect pests. *Steinernema* spp., *Heterorhabditis* spp. and *Oscheius* spp. are obligate pathogen of insect in nature. They are found in a variety of soil, various species and isolates exhibit considerable variation in terms of host range, infectivity, conditions for survival, temperature, soil moisture and compatibility with chemicals, easy to handle, short life cycle, economically produced at large scale and environmentally safe.

EPNs are symbiotically associated with bacteria which are released into the insect hemocoel, causing septicaemia and death of the insect. The EPN are mutually associated with bacteria feeding in group Steinernematids and Heterorhabditids belong to the genus *Xenorhabdus* and

Photorhabdus. *Xenorhabdus* occurs naturally in a special intestinal vesicle of *Steinernema* infective juveniles, while *Photorhabdus* are mainly located in the anterior part of *Heterorhabditis* infective juveniles. These bacteria are medium to long motile rods with peritrichous flagellae. They are gram negative, facultative, anaerobes and form spheroplasts ($\times=2.6$ microns dia.) in older cultures. Non spore formers, *Xenorhabdus* spp. do not have an environmentally resistant stage and have not been naturally found except in the nematode vectors or insect hosts.

For enhanced biocontrol potential local native species which can tolerate local climatic conditions have to be isolated. It is highly important to accurately identify the species status of specimens obtained for effective management.

For a biocontrol agent to be successful it should be amenable for mass production on large scale and the ready availability of the organism in required quantity and at competitive cost makes them acceptable among entrepreneurs and farmers. The EPN are multiplied either on a suitable host (*in vivo*) or on a semi synthetic diet (*in vitro*).

For the field application, large number of infective juveniles is required, in case of *in vivo* production of EPN one of the major problem is availability of host insect and this method is also very costly. *In vitro* production of EPN is best option for production of IJs on large scale. Promising EPNs can be produce in large scale using different artificial media. Among them, maximum production of infective juveniles (IJs) was recorded in egg yolk and Wouts medium, which was economically better than universally used dog food biscuit agar.

Various options for pest management in spices are available. However, in case of severe infestation, these measures fail miserably and farmers are left with no choice. Chemicals do act fast and effectively but due to faulty planning and use of wrong chemicals, incorrect dosage and time of application, these become curse rather than boon. Very soon they become ineffective due to development of resistance. The chemicals often do not give desired degree of control due to feeding habit of pests, weather conditions like rains, heavy wind, spurious products, etc. One of the ideal methods of pest management is biological control, where the various living organisms are deployed to check the damage caused by other living organisms. Recently, EPNs are important group of organism, which are emerging as potent biocontrol agent against insect pests.

Influence of sowing time and seed rate on the growth and yield of BARI Mung-6

Chaity Dey Puja, A.K.M. Ruhul Amin and Babu Lal Nag

Department of Horticulture, Faculty of Agriculture, Sher-e-Bangla Agricultural University, Dhaka, Bangladesh

Purpose

Bangladesh has suitable agro-ecological conditions for production of a number of pulses. In terms of both acreage and production mungbean occupies third position after lentil and blackgram. For the last few years, farmer lost interest to produce mungbean in spite of having high market value to this crop duct to lack of proper agronomic practices. From these perspectives, the study was conducted to evaluate the effect of sowing time and seed rate on the growth and yield of BARI Mung-6.

Key words: Sowing time, seed rate, BARI Mung-6.

Methods

The experiment consisted three sowing times ($T_1= 01$ March, $T_2= 10$ March, $T_3= 20$ March, 2018, respectively) and four seed rates ($S_1= 20$ kg ha⁻¹, $S_2= 25$ kg ha⁻¹, $S_3= 30$ kg ha⁻¹, $S_4= 35$ kg ha⁻¹). The experiment was laid out in split-plot design with four replications. The collected data were computed and analysed using MSTAT-C software program following AVONA techniques. The mean differences were adjusted by Least Significant Difference (LSD) test at 5% level of significance.

Results

Results revealed that sowing on 10 March gave the highest seed yield (1.33 t ha⁻¹) and 30 kg ha⁻¹ was the highest seed yielder (1.32 t ha⁻¹). This may be attributed to the maximum number of pods plant⁻¹, pod length, number of seeds pod⁻¹, weight of 100-seed (data not shown). Among the treatment combinations, the maximum number of pods plant⁻¹(34.5) and weight of 100-seed (5.51g) were found from T_2S_3 which was statistically similar with T_2S_4 , T_3S_3 . In case of seed yield, the highest seed yield was exhibited from T_2S_3 treatment combination which was statistically similar with T_2S_4 , T_3S_2 , T_3S_3 .

Conclusions

In conclusion, it may be said that mungbean grower may cultivate BARI Mung-6 under prevailing climatic condition of southern region of Bangladesh in the month of March 10-20 along with 25-35 kg ha⁻¹ seed rate to get the maximum seed yield. The further research should be carried out in different agro-ecological zones (AEZ) of Bangladesh and other production inputs should be used for further study to standardize the best agronomic management practices.

Morpho-Physiological and Biochemical Responses of Napier Grass under Water Stress Conditions

Faria Jannat^o, Taufika Islam Anee, Mst. Mahbuba Khatun, Mirza Hasanuzzaman*

Department of Agronomy, Sher-e-Bangla Agricultural University, Dhaka-1207, Bangladesh

Purpose

Napier grass (*Pennisetum purpureum*) is grown in tropical and temperate regions well adopted as a fodder crop because of its high forage productivity and rapid regeneration. It is considered as drought tolerant and shows high water use efficiency. Our study investigated the water stress-induced morphological, physiological and oxidative damages in napier grass and to differentiate between the responses of napier grass to drought and waterlogging conditions.

Keywords: Elephant grass, fodder crop, drought, waterlogging, oxidative damage, osmotic stress.

Methods

Napier grass was grown in 14-L pots up to 21 days and exposed to water stress: viz. drought and waterlogging for different durations (7, 14 and 21 days). At the completion of each stress period, morphological, physiological and biochemical data were measured following standard procedures. At 50 days after sowing the same parameters were recorded for all treatments and considered as recover data.

Results

Plant height, SPAD value, fresh weight, dry weight, relative water content, fodder yield decreased under both waterlogging and drought stress conditions compared to control. The reduction was higher under drought condition than waterlogging. Root length, root shoot ratio, proline, malondialdehyde (MDA) and H₂O₂ content were higher under stress conditions compared to control. Drought stressed plants were more severely affected than waterlogged one. At 50 days after sowing, plant height, shoot fresh weight, shoot dry weight and fodder yield were decreased in plants stressed for longer periods. Root fresh weight, root dry weight, root length and root branch were decreased in plants stressed for 21 days, whereas increased under waterlogging. Proline, MDA and H₂O₂ content were increased upon exposure to long duration of stress. As plants stressed for 7 days got highest days for recovery, so it showed better performance and even better than control.

Conclusion

Our experiment concludes that napier grass is more sensitive to drought than waterlogging in case of morphology and plants also recovered efficiently in case of waterlogging than drought. In case of oxidative damage, drought exposed plants showed more tolerant capacity compare to waterlogged plants.

Enhancement of Salt Stress Tolerance in *Glycine Max* by Zinc Priming

Farzana Nowroz^δ, Md. Rakib Hossain Raihan, Mirza Hasanuzzaman*

Department of Agronomy, Sher-e-Bangla Agricultural University, Dhaka-1207, Bangladesh

Purpose

Soybean (*Glycine max* L.) is one of the principal food plants in world with an abundant supply of protein and oil content and has versatile uses in human, animal and plants. Though soybean is considered as a moderately saline tolerant crop, its productivity is impaired due to the salt stress depending on the genotypes. Priming of seed with micronutrients can increase plant tolerance to salinity. The objective of the experiment was to determine the performance of soybean under salinity after Zinc (Zn) priming.

Keywords: Soybean, Oilseed crop, Salinity, Micronutrient, Hydropriming, Osmotic stress.

Methods

Soybean seeds were pretreated with two doses of ZnSO₄.7H₂O (0.5 and 1 mM) and then seedlings were grown in shed house exposed to different levels (50, 100 and 150 mM NaCl) of salt. Morphological and physiological changes were recorded to compare the performance and proline content was also measured to understand the severity level of salt stress among the seedlings.

Results

Under high salt concentrations (150 mM NaCl), plants showed reduced plant height, stem diameter, branch number, SPAD value, relative water content, fresh weight and dry weight and an increased proline content compared to control condition. In contrary, seed with Zn priming revoked the negative effect of salinity by increasing plant height, stem diameter, branch number, relative water content, fresh weight and dry weight.

Moreover, proline content was seen to decrease significantly in plants with pretreated seed even under high salt concentrations. Between the two doses of ZnSO₄·7H₂O priming (0.5 mM and 1 mM), 0.5 mM ZnSO₄·7H₂O priming showed better performance in most of the cases.

Conclusion

The study highlighted the better performance of Zn priming over control seed conditions in soybean. So, seed priming can be used as an effective tool to alleviate salt stress in soybean and improve the productivity.

Improving Rice Productivity in Cadmium-Contaminated Soil using Azolla: Study on Cadmium Accumulation, Antioxidant Defense and Glyoxalase Pathway

Kamrun Nahar^{1*}, Mirza Hasanuzzaman², Khursheda Parvin³, Sayed Mohammad Mohsin⁴, Kamal Uddin Ahamed¹ and Masayuki Fujita^{5*}

¹Department of Agricultural Botany, ²Department of Agronomy, ³Department of Horticulture, ⁴Department of Plant Pathology, ⁵Laboratory of Plant Stress Responses, Sher-e-Bangla Agricultural University, Dhaka-1207, Bangladesh

Purpose

Azolla (*Azolla pinnata*) is known for supplying nitrogen and organic matter to soil. Azolla can be an effective agent for phytoremediation and reclamation of heavy metals including cadmium (Cd) contaminated water or soil. The present study investigates the role of azolla addition in reducing Cd accumulation, reducing oxidative stress and methylglyoxal toxicity, improving physiological attributes, growth and yield of rice grown in Cd contaminated soil.

Keywords: Azolla, Phytoremediation, Heavy metal, Rice, Antioxidant defense, Glyoxalase system.

Methods

Rice (*Oryza sativa* L. cv. BRRI dhan29 and cv. BRRI dhan47) seedlings at 45 days after sowing (DAS) were exposed to 0.5, 1.0 and 1.5 mM CdCl₂ alone and in combination with azolla. Data on physiological attributes, growth and yield were recorded.

Results

Cadmium stress resulted oxidative damage, hampered growth and development. Application of azolla in Cd-treated rice plants reduced Cd content, increased leaf relative water content, regulated the proline level, improved chlorophyll content, ascorbate (AsA) and glutathione (GSH) content, ratio of AsA/dehydroascorbate (DHA) and GSH/glutathione disulfide (GSSG), activities of superoxide dismutase, catalase, glutathione peroxidase, glutathione-S-transferase, ascorbate peroxidase, monodehydroascorbate reductase, dehydroascorbate reductase and glutathione reductase, compared to Cd affected rice plants. Azolla inclusion decreased the oxidative damage of Cd-stressed rice plants. Upregulation of glyoxalase I and glyoxalase II activities by the azolla inclusion reduced the methylglyoxal toxicity. Growth, development and yield were also increased by azolla addition in Cd treated rice plants.

Conclusion

Reduction of Cd accumulation and content in rice, improvement of antioxidant defense and glyoxalase system, physiological and biochemical processes by azolla addition improved the overall growth,

development and yield of rice plants. Thus, azolla proves itself as a promising agent for reclamation of Cd contaminated water or soil for making it suitable for rice cultivation.

Vanillic Acid Pretreatment-induced Modulation of Physiology, Antioxidant Defense and Glyoxalase Systems to Improve Drought Tolerance of Tomato

Khursheda Parvin¹, Mirza Hasanuzzaman^{2*}, Sayed Mohammad Mohsin^{3,4}, Kamrun Nahar⁵ and Masayuki Fujita⁴

¹Department of Horticulture, ²Department of Agronomy, ³Department of Plant Pathology, ⁵Department of Agricultural Botany, Sher-e-Bangla Agricultural University, Dhaka-1207, Bangladesh

⁴Laboratory of plant stress response, Department of Applied Biological Sciences, Faculty of Agriculture, Kagawa University, Miki-Cho, Kita-Gun, Kagawa 761-0795, Japan

Purpose

As a phenolic compound, vanillic acid (VA) significantly regulates various physiological and biochemical processes in plant upon abiotic stress condition. In addition, water shortage is one of the prime environmental stresses which limits plant growth and survival. In such circumstances, VA-induced protection against water deficit in tomato (*Solanum lycopersicon* L. cv. BARI tomato 16) has been studied with the view of increasing their stress tolerance.

Keywords: Antioxidant defense, Cellular damage, Glyoxalase system, *Solanum lycopersicum* L., Phenolic compound, Drought.

Methods

Vanillic acid (50 µM; 2 days) was applied as pre-treatment before treating water stress imposed by withholding water and 12% polyethylene glycol (PEG-6000) for 4 d in hydroponically grown tomato seedling (8-d-old).

Results

Exogenous VA enhanced seedlings growth and biomass accumulation, photosynthetic pigments under stress condition. Seedlings with VA pretreatments showed better water relation by increasing water status and proline content. Vanillic acid significantly up regulated the antioxidants responses including both enzymatic and non-enzymatic components in stress-treated seedlings resulted in decrease of reactive oxygen species generation and membrane damage. Although, methylglyoxal detoxification was ensured in VA-pretreated stressed seedlings by strengthening the glyoxalase enzymes activities.

Conclusion

Role of VA in alleviating water deficit-induced injury in tomato has been explored and VA could be important regulator for increasing tolerance in plant through inducing activation of plant antioxidant defense and glyoxalase systems.

Insight into the Mechanisms of Salt and Drought Tolerance in *Chenopodium album*

Khussboo Rahman^δ, Mira Rahman and Mirza Hasanuzzaman^{*}

Department of Agronomy, Sher-e-Bangla Agricultural University, Dhaka-1207, Bangladesh

Purpose

Exploring the tolerant plants and understanding is one of the missions of plant physiologists for the climate resilient agriculture. Understanding the salt and drought tolerance mechanism of halophytes may be a basis for future crop improvement in the era of climate change. In this study, we investigated the responses of a salt tolerant weeds, *Chenopodium album*, to different levels of salt and drought stress.

Keywords: Salt stress, Oxidative damage, Water deficit, Enzyme activity, Glyoxalase system.

Methods

Landrace of *C. album* was grown in 14-L plastic pots. At 15th days after transplanting plants were exposed to different level of salt and drought stress. Three doses of NaCl (mild, 250 mM; moderate, 500 mM; and severe, 1000 mM) were applied for salt stress and three water deficit condition (mild, 50% depletion from field capacity, FC; moderate, 75% depletion from FC; and severe, 87.5% depletion from FC) were applied to impose drought stress on plants.

Results

C. album showed resistance towards mild level of salt (250 mM NaCl) and drought stress (50% depletion from FC) and showed no significant changes in plant morpho-physiology due to their elevated level of stress defense mechanism. However, *C. album* could not cope with moderate and severe level of both stress treatments and drastically reduced plant height, shoot fresh weight and dry weight, stem diameter, SPAD value and leaf relative water content of plant. A sharp increase in proline content was noticed in both stress condition. Moderate and severe doses of salt and drought stress imposed oxidative damage on plants which elevated the levels of lipid peroxidation, electrolyte leakage and H₂O₂ content in a dose dependent manner. They also altered ascorbate and glutathione contents along with antioxidant enzymes activities and glyoxalase system which are crucial for plants to fight against abiotic stress.

Conclusion

Substantial damage of growth and oxidative stress tolerance of *C. album* was observed during the exposure of moderate and severe doses of salt and drought stress and it became more deleterious with the increase of stress levels.

Role of Different Organic Amendments in Mitigating Drought Stress-Induced Oxidative Stress in *Triticum aestivum*

Taufika Islam Anee^δ, Md. Nur Nabi Islam, Abdul Awal Chowdhury Masud, Mahabub Alam, Mirza Hasanuzzaman*

Department of Agronomy, Sher-e-Bangla Agricultural University, Dhaka, Bangladesh

Purpose

In the present era of unpredictable climate change, drought stress is being considered as one of the major threats to agricultural production. Most of the cultivated crops require sufficient supply of water to ensure the maximum productivity. Wheat (*Triticum aestivum*) being a winter crop frequently faces scarcity of water and results into a lower yield. Therefore, this experiment aims to explore the role of different organic fertilizers in mitigating drought stress-induced damage.

Keywords: Cereal crop, Compost, Vermicompost, Poultry manure, Biochar, Chitosan, Reactive oxygen species, Antioxidant defense.

Methods

The pot experiment was carried out at the experimental net house of Sher-e Bangla Agricultural University, Bangladesh with BARI gom-26 as the test crop and following treatments: well-watered, water deficit and organic amendments viz. control (C), compost (CO) @10 t ha⁻¹, vermicompost (VC) @10 t ha⁻¹, poultry manure (PM) @10 t ha⁻¹, biochar (B) @2.5% w/w soil and chitosan (CH) @1% w/w soil. Morphological, physiological, oxidative stress indicators and antioxidant enzymes data were measured following standard procedures.

Results

Drought stress reduced germination (7.48%), plant height (15.02%), SPAD value (15.91%), relative water content (13.44%), number of spikelet spike⁻¹ (16.92%), number of grains spike⁻¹ (11.73%), and hundred grains weight (17.83%). Organic amendments act as a protectant and reduces drought stress-induced damages by enhancing the growth, physiological, yield and yield attributes. Compost application increased germination by 12%, VC enhanced SPAD value by 17.52%, number of spikelets spike⁻¹ by 19.92%, number of grains spike⁻¹ by 16.62%, whereas PM increased plant height by 16% under drought condition compared to control plant. Unlike other organic amendments applied, VC was proved to be capable of reducing the higher lipid peroxidation (MDA) and proline content raised by water deficit condition. Drought stress-induced increment of CAT, APX and GR activities were also efficiently modulated by the organic amendment application.

Conclusion

The present study concluded that organic amendments play significant role in alleviating drought stress-induced damages by improving the morpho-physiological attributes and among the different types of organic amendments used VC performed better which in addition ceased the production of ROS.

Morpho-phenetical diversity of white jute cultivars in Bangladesh

M.M. Mukul*, M.H. Rashid, N. Akter

Breeding Division, Bangladesh Jute Research Institute, Ministry of Agriculture, Dhaka-1207, Bangladesh.

ABSTRACT

Among all the natural fibrous plants, jute (*Corchorus* spp.) is second to cotton in respect of commercial fibre production. Jute is a secondary phloem fibre obtained from the bark of the stem, and it is known as golden fibre of Bangladesh. Among all the species under *Corchorus* genus, only two species namely White jute (*Corchorus capsularis* L.) and Tossa jute (*C. olitorius* L.) of the family *Tiliaceae* yield jute. These two cultivated species contain ~70% of the neutral genetic diversity present in their wild relatives. *C. capsularis* is different with *C. olitorius* in terms of some qualitative traits i.e. biotic (diseases, insects) and abiotic (salinity, drought, flood) stress tolerant, high lignin ($\approx 14\%$) & low cellulose ($\approx 60\%$) hemicellulose ($\approx 23\%$) contents etc. The large amount of the world's supplies of jute is grown in Bangladesh, India, China, Thailand, and Nepal. Bangladesh Jute Research Institute (BJRI) has developed 25 fibre type and 3 vegetable type white jute varieties in Bangladesh. These vegetables are highly nutritive containing dietary and crude fibre, and are very useful for the diabetic patients. Among the fibre type varieties, BJRI Deshi Pat 8 & 10 are salt tolerant (9 & 12 dSm⁻¹, resp.) with 2.9-3.0 t ha⁻¹ fibre yield capacity. The quality of white jute fibre is comparatively low than tossa jute fibre; but, yield is high with low production cost due to stress resistance ability. The popular ten white jute varieties were investigated for yield attributing morphological traits where, BJRI Deshi Pat 6 (BJC-83), BJRI Deshi Pat 8 (BJC-2197) and D-154 (2) were found best performer for stem height (2.78, 2.83, 2.57m, resp.), stem diameter (22.00, 20.33, 18.17mm, resp.) and fibre yield per plant (27.67, 25.67, 25.33 g, resp.) as well as dry matter content. The studied morphological characters i.e. plant height, stem diameter, fresh weight of fibre & stick plant⁻¹, dry weight of fibre & stick plant⁻¹ showed highly significant associations among them. These varieties would be recommended for commercial cultivation to boost up the national economy and may be used for varietal improvement through breeding approaches in future.

Determination of LD₅₀ for Chemical (EMS) Mutation in White Jute (*Corchorus capsularis* L.) under laboratory condition

MM Mukul*, MH Rashid, SSU Ahmed, M Al-Mamun, MM Islam, SA Jui, IJ Nur, SK Biswas, MG Mostofa, N Akter

Breeding Division, Bangladesh Jute Research Institute, Ministry of Agriculture, Dhaka-1207, Bangladesh.

ABSTRACT

Jute is the golden fibre of Bangladesh. Jute leaves are used as vegetable for antioxidants, vitamins, minerals, dietary and crude fibre contents. *Corchorus capsularis* L. (white jute) and *C. olitorius* L. (Tossa jute or dark jute) are only two cultivated jute species under *Tiliaceae* family of the genus *Corchorus*. Jute is a self-pollinated crop having narrow genetic base with 2-3% outcrossing in white jute and 10-12% outcrossing in tossa jute. The conventional breeding is vary lengthy and difficult to develop stress tolerant variety. A large area is saline affected in southern regions of Bangladesh. So, development of biotic (diseases, pests) and abiotic (salinity, drought, flood, photo insensitivity) stress tolerant white jute variety is very essential to increase productivity and area under cultivation here. The mutation plant breeding is the most popular,

widely used and globally accepted method to develop the stress tolerant cultivars with nutrient contents and higher yield potentials. Ethyl Methane Sulphonate (EMS), Sodium Azide, Gamma Radiation, X-ray etc. are used as mutagenic agents. The present investigation was conducted to identify the lethal dose₅₀ (LD₅₀) in white jute variety CVL-1 induced by EMS under laboratory condition. The seeds were treated with different concentrations (25, 50, 75, 100, 125, 150, 175, 200, 225, 250 mM) along with control (0.0 mM) of Ethyl Methane Sulphonate (EMS) at germination to seedling stage to create variability during September, 2021. The first stage in the research was the determination of LD₅₀ value for white jute. The effects of mutagen on seed germination (%) and seedling traits like, root & shoot length, normal & abnormal seedlings, growth status were observed carefully in accordance with the Standard Seed Testing Association (ISTA). The seed germination (%) and seedling growth were decreased with increase in doses or concentrations of the mutagen. The lethal dose 50 (LD₅₀) was found at 150mM of EMS treatments. The treated seedlings will be transferred to field condition for further observation and the information would be used in future for jute crop improvement.

Fixation of Lethal Dose 50 (LD₅₀) for Ethyl Methane Sulphonate (EMS) Mutation in Tossa Jute (*Corchorus olitorius* L.) under laboratory condition

MM Mukul*, SSU Ahmed, MM Islam, N Akter, MG Mostofa

Breeding Division, Bangladesh Jute Research Institute, Ministry of Agriculture, Dhaka-1207, Bangladesh.

ABSTRACT

Jute is an important natural fibre crop of *Tiliaceae* family under *Corchorus* genus bearing diploid type chromosome ($2n=2x=14$). *C. olitorius* is one of the two cultivated jute species of *Corchorus* genus. It is a self-pollinated (10-12% outcrossing) crop having lower chance of genetic variability through natural mutation. It is known as tossa jute in some countries including Bangladesh in the world. It was originated in Africa where it was used as vegetable; and also using in Bangladesh as a good source of antioxidants, vitamins, minerals, dietary fibre etc. The demand of tossa jute is high in market today, so there is a need to enhance the productivity and area under tossa jute cultivation in Bangladesh. The chemical constituents like low lignin, high cellulose, hemi-cellulose etc. and physical properties like fibre fineness, lusture, twistness, bundle strength etc. in tossa jute result the good quality fibre than *C. capsularis*. The tossa jute is high yielding and it is nearly 80% of cultivated jute in Bangladesh. Tossa jute is less tolerant to biotic (diseases, pests) and abiotic stresses (salinity, drought, flood, photo insensitivity) than white jute (*C. capsularis*) due to its origin in Africa where *C. capsularis* was originated in Indian sub-continent. Development of stress tolerant tossa jute variety is very essential for market demand in Bangladesh. The mutation plant breeding is the most popular, widely used and globally accepted method to develop the stress tolerant cultivars with nutrient contents and higher yield potentials. Ethyl Methane Sulphonate (EMS), Sodium Azide, Gamma Radiation, X-ray etc. are used as mutagenic agents. Hence, three tossa jute varieties i.e. BJRI Tossa Pat 5, O-9897 and JRO-524 were treated with different concentrations (25, 50, 75, 100, 125, 150, 175, 200, 225, 250 mM) along with control (0.0 mM) of Ethyl Methane Sulphonate (EMS) at germination to seedling stage to create variability under laboratory condition during September, 2021. The first stage in the research was the determination of LD₅₀ value for tossa jute. The germination (%), number of normal & abnormal seedlings, growth of roots & shoots were recorded carefully in accordance with the Standard Seed Testing Association (ISTA). The results showed variations in the studied parameters as compared to control where near about 50% seedlings were found normal at 120-125 mM concentration of EMS. The treated seedlings will be transferred to field condition for further observation and the information would be used in future for jute crop improvement.

Evaluation of Different Millet Based Inter Cropping Systems under Organic Farming in Northern Transitional Zone of Karnataka

R. Basavarajappa*

College of Agriculture, Hanumanamatti (UAS, Dharwad), Ranebennur (Tq), Haveri (Dist), Karnataka-581 115

ABSTRACT

Nutrient availability in the soil has become a limiting factor in the production of crops under the optimum conditions of all other resources, as the soil's capacity to supply the required nutrients has been challenged by many factors. Reduced nutrient loss, direct availability of nutrients, lower fertilizer requirements and a high B:C ratio are advantages of organic sources over fertilizer sources of nutrients. In this context two-year field trial was conducted in Main Agricultural Research Station, Dharwad (Karnataka), in medium black soils to evaluate the millet based intercropping system with millets 4:2 row proportion. Five millet based intercropping systems with six nutrient levels were evaluated under strip block design. The pooled analysis of two years data revealed that 100 % RDF + FYM (RPP) recorded significantly higher yield (1893 kg ha⁻¹) of foxtail millets, finger millet equivalent yield (2240 kg ha⁻¹), pigeonpea yield (852 kg ha⁻¹), pigeonpea equivalent yield (1429 kg ha⁻¹) and higher net returns (25, 557 Rs ha⁻¹) as compared to other treatments. However, 50 % RDN (Organics) + 50 % RDN (inorganics) recorded significantly higher system net returns (64, 931 Rs ha⁻¹). Further, among the organics 100 % RDN (Organics) recorded significantly higher yield (1675 kg ha⁻¹) of foxtail millets, finger millet equivalent yield (1907 kg ha⁻¹), pigeon pea yield (711 kg ha⁻¹), pigeonpea equivalent yield (1202 kg ha⁻¹) and higher net returns (47,557 Rs ha⁻¹) as compared to 50% RDN (Organics) and 75 % RDN (Organics). Among the different millets + pigeonpea intercropping system, finger millet + pigeonpea intercropping system recorded significantly higher finger millet equivalent yield (3148 kg ha⁻¹), pigeonpea equivalent yield (1485 kg ha⁻¹), net return (47, 557 Rs. ha⁻¹) and higher system net returns (81, 717 Rs. ha⁻¹) as compared to other intercropping systems.

Keywords : Pigeonpea, Millets, Intercropping System, Organics, Equivalent yield

Effect of Different Inorganic, Organic and Bio-Fertilizers on Plant Growth of Sweet Orange (*Citrus sinensis* Osbeck.)

Johnson Lakra^{1*}, Muktilata Tirkey², Ravina Pawar¹ and Panma Yankit¹

¹Dr Y. S. Parmar University of Horticulture and Forestry Nauni, Solan-173230, H.P., India

²Department of Vegetable Science, IGKV, Raipur-492006, Chhattisgarh, India

ABSTRACT

The present investigation entitled —Effect of different Inorganic, Organic and Bio-fertilizers on plant growth of Sweet Orange (*Citrus sinensis* Osbeck) were carried out at experimental field, Department of Horticulture, Allahabad School of Agriculture, Sam Higginbottom Institute of Agriculture, Technology and Sciences Allahabad (Uttar Pradesh) during the year (2015-2016). The experiment was laid out in Randomized Block Design (RBD) with thirteen treatments and each replicated thrice. The treatment T6 (20 kg/plant Farm Yard Manure, 10 g/plant PSB, 10 g/plant *Azospirillum*, Nitrogen 337 g/plant, Phosphorus 112 g/plant and Potash 75g/ plant was found to be the most suitable in terms of maximum plant height (119.87 cm), maximum number of leaves (400.90), maximum number of branches (29.83), maximum stem diameter (2.40 cm), maximum spread of canopy (75.62 cm²), maximum Leaf area (32.46 cm²), maximum length of inter-nodes (8.60 cm) and minimum incidence of disease percentage (1.10 %) followed by treatment T12 (20 kg/plant Farm Yard Manure, 10 g/plant PSB, 10 g/plant *Azospirillum*, Nitrogen 225 g/plant, Phosphorus 75 g/plant and Potash 50 g/plant, whereas the minimum parameters were found associated with (T0) control. The nutrient status of soil like EC, Nitrogen, Phosphorous and Potassium were also higher with treatment T6 and the maximum pH was recorded with (T0) control. The results of the present study suggested that combination of Inorganic, Organic and Bio-fertilizers are responsible for increased growth of sweet orange.

Keywords: Sweet orange, FYM, PSB, *Azospirillum*, Soil nutrients

Effect of silicon application on growth and yield attributes on rice (*Oryza sativa* L.) under normal and water stress condition

Thi Thi Myint (Myanmar)

Deptt. of Plant Physiology, CBSH, G.B.Pant University of Agriculture and Technology, Pantnagar, Uttarakhand

ABSTRACT

Silicon (Si) is a beneficial plant mineral nutrient that has been shown to increase biotic and abiotic stress resilience as well as crop productivity in a variety of crops. Silicon is thought to be a useful ingredient in rice production. In this study, a field experiment was conducted during 2020 at the research farm of G.B. Pant University of Agriculture and Technology, Pantnagar (Uttarakhand). The experiment was arranged as split-plot design with four treatments: control (T1), Si fertilization (T2), Si fertilization + Drought stress (T3), and Drought stress (T4) and replicated thrice. Silicon fertilizers increased plant height, tiller number, 1000-grain weight, and yield significantly, according to the findings of the experiment. The results showed that all growth and yield parameters were positively influenced on rice by silicon application under normal and water stress condition.

Key words: Silicon, Rice, Plant height, Yield

Seroprevalence of brucellosis in raw milk sample in Jaipur city

Raghavendra Prasad Mishra*, Rizwan Khan, A. Bhattacharya

Department of Veterinary Public Health and Epidemiology, Apollo College of Veterinary Medicine, Jaipur, Rajasthan

ABSTRACT

Brucellosis is one of the major recognized occupational zoonotic threats among animal handler and raw animal product consumers. In India, close association and feeding habits is major thread to transmission of the disease and causing an extended debilitating illness. In the present study total of 150 milk sample from different sources (milk vendors-70, retail shop-35, dairy forms-20 and gaushalas-25) were collected from Jaipur city and screen out for detection of brucellosis by milk ring test. The overall seroprevalence of brucellosis in milk sample was 6% (9/150). Prevalence of brucellosis in milk to this region may have public health significance so that for the prevention and control of brucellosis health education program is essential to generate awareness for brucellosis in the community to prevent animal to human disease transmission.

Keywords: Prevalence, Brucellosis, Milk, MRT, Jaipur

An improvement in biochemical properties of curd in sprouting broccoli [*Brassica oleracea* (L.) Plenck var. *italica*] by micronutrients and organics

Manju Netwal^{1*}, M R Choudhary², O P Garhwal³ and S P Singh⁴

1. *Department of Horticulture, SKN College of Agriculture, Jobner, Rajasthan, India*

2. *Department of Horticulture, SKN College of Agriculture, Jobner, Rajasthan, India*

3. *Division of Horticulture, Rajasthan Agricultural Research Institute, Durgapura, Jaipur, Rajasthan, India*

4. *Department of Horticulture, SKN College of Agriculture, Jobner, Rajasthan, India*

ABSTRACT

Field experiments were conducted in *rabi* season 2019-20 and 2020-21 at Horticulture Farm, S.K.N. College of Agriculture, Jobner (Jaipur) to study the change in biochemical properties of curd in sprouting broccoli through use of micronutrients and organics. Experiments laid out in RBD having twenty five treatments with three replications. The treatment consisted of five micronutrients (control, Borax at 15 kg/ha, Zinc sulphate at 25 kg/ha, Ammonium molybdate at 1.5 kg/ha and Manganese sulphate at 10 kg/ha) and five organics (control, Cow urine 10%, *Panchagavya* 5%, Vermiwash10% and *Azotobacter*).

The results indicated that soil application of zinc sulphate to the sprouting broccoli significantly improved various biochemicals in curd. *i.e.* TSS (10.88 °Brix), protein (2.30 %) content, nitrogen (0.368 %), potassium (0.266 %) and zinc (44.22 ppm) content. Similarly, foliar application of *Panchagavya* at 5% also increased the biochemicals in curd upto the level of significance *viz.*, TSS (11.69 °Brix), protein (2.40 %) content, nitrogen (0.376 %), phosphorus (0.073 %), potassium (0.282 %), boron (16.99 ppm), zinc (38.89 ppm), molybdenum (1.97 ppm) and manganese (66.82 ppm) content in pooled analysis of both year. The findings were in conclusion that soil application of zinc sulphate at 25 kg/ha

3rd International Conference on “Global Initiative in Agricultural, Forestry and Applied Sciences for Food Security, Environmental Safety and Sustainable Development (GIAFAS-2021)”

and foliar application of *Panchagavya* at 5% have the potential effect to improve quality parameters in sprouting broccoli.

Race specific adult plant resistance test against selective prevalent stem rust pathotypes under glasshouse condition

V. M. Sali^{*}, M. A. Sushir, D. S. Kadam, M. A. Gud and D. P. Deshmukh

**Regional Wheat Rust Research Station, Mahabaleshwar, Pin code:412806, Dist: Satara (MS), India*

ABSTRACT

Fifty nine wheat genotypes from AVT (Central and Peninsular Zones) were screened at adult stage under glasshouse condition for evaluating their resistance to pathotypes of stem rust viz., 40A and 117-6. Among these, twelve wheat genotypes viz., CZ-TS-102, CZ-TS-104, CZ-TS-113, CZ-RI-302, CZ-LS-202, PZ-TS-101, PZ-LS-202, PZ-LS-206, PZ-LS-207, PZ-RI-306, PZ-RI-309 and PZ-RI-311 were resistant to 40A whereas, eight genotypes viz., CZ-TS-101, PZ-TS-101, PZ-TS-106, PZ-TS-111, PZ-LS-201, PZ-LS-203, PZ-LS-206 and PZ-LS-207 were resistant to 117-6. Out of total genotypes evaluated, three genotypes viz., PZ-TS-101, PZ-LS-206 and PZ-LS-207 were found resistant to both the pathotypes 40A and 117-6 under glasshouse condition. These AVT genotypes resistant to both pathotypes of stem rust 40A and 117-6 are recommended for further breeding programme.

Keywords: Advanced Varietal Trial (AVT), Adult Plant Resistance Test (APRT), Pathotypes

Seedling resistant test of wheat genotypes against selective pathotypes of stem and leaf rusts under glass house condition

M. A. Sushir^{*}, D.S. Kadam, V. M. Sali, M. A. Gud and D.P. Deshmukh

**Regional Wheat Rust Research Station, Mahabaleshwar, Pin code 412806 Dist. Satara MS, India*

ABSTRACT

Fourty six AVT (I and II) wheat genotypes received from the Indian Institute of Wheat and Barly Research, Karnal (Haryana) during *Rabi* 2017-18 were screened for testing their resistance against selective and virulent pathotypes of stem and leaf rusts under glass house condition. These genotypes were tested at seedling stage against thirteen pathotypes of stem rust viz. 11, 21-1,34-1, 40A, 42, 42-B, 117, 117A, 117-2, 117-3, 117-6, 122 and 184 and fourteen pathotypes of leaf rust viz. 77, 77A1, 77-4, 77-5, 77-9, 104A, 104-1, 104-2, 12A, 12-2, 12-3, 12-5, 162A and 108.

Among them, seventeen wheat genotypes viz., CZ-TS-106, CZ-TS-107, CZ-RI-301, CZ-RI-302, CZ-RI-304, PZ-TS-102, PZ-TS-103, PZ-TS-104, PZ-TS-105, PZ-TS-106, PZ-TS-107, PZ-TS-108, PZ-TS-114, PZ-TS-116, PZ-TS-117, PZ-RI-304 and PZ-RI-312 were found resistant to stem rust disease of wheat. While, thirteen wheat genotypes viz., CZ-TS-106, CZ-TS-107, CZ-RI-304, PZ-TS-101, PZ-TS-102, PZ-TS-103, PZ-TS-105, PZ-TS-106, PZ-TS-114, PZ-TS-115, PZ-TS-117, PZ-RI-301 and PZ-RI-311 were found to be resistant to leaf rust disease of wheat. Whereas nine genotypes viz., CZ-TS-106, CZ-TS-107, CZ-RI-304, PZ-TS-102, PZ-TS-103, PZ-TS-105, PZ-TS-106, PZ-TS-114 and PZ-TS-117 were resistant to both rusts under glasshouse condition.

These AVT genotypes resistant to both rust pathotypes are recommended for further breeding programme.

Keywords: Advanced Varietal Trial (AVT), Pathotypes

***In vitro* antifungal activity of essential oils against *Rhizoctonia solani* causing sheath blight of rice**
Udaykumar Thera^{1*}, Ashmita Timsina¹

¹Department of Mycology and Plant Pathology, Institute of Agricultural Sciences, Banaras Hindu University, Varanasi-221005, Uttar Pradesh, India

ABSTRACT

Rice (*Oryza sativa* L.) is an important source of carbohydrates, protein, and other minerals for billions of people throughout the world. Several pathogens directly impact rice productivity, in which sheath blight (ShB) disease, caused by *Rhizoctonia solani* Kuhn, being among the most devastating pathogens causing disease in rice. In the present study, antifungal activity of ten essential oils against *R. solani* was tested in the concentration range of 200 to 1000 ppm by radial assay following poisoned food technique. The highest inhibitory effects on *Rhizoctonia solani* were recorded after 3 days in a treatment containing *Syzygium aromaticum* at a minimum concentration of 500 ppm which was followed by

3rd International Conference on “Global Initiative in Agricultural, Forestry and Applied Sciences for Food Security, Environmental Safety and Sustainable Development (GIAFAS-2021)”

Zingiber officinale and *Cymbopogon nardus* (600 ppm) and *Ocimum citriodorum* (700 ppm). Results revealed that all the tested essential oils showed inhibitory effects against *Rhizoctonia solani*. This ability was dose-dependent. However, *Pogostemon cablin* and *Chrysopogon zizanioides* oils were found less effective against *R. solani* at lower concentrations.

Keywords: Rice, *Rhizoctonia solani*, Antifungal activity, Essential oils, poisoned food technique

The wisdom for dual role of rural women in household and papad making enterprise for their livelihood in Bihar state

Rambha Kumari * and Shishir Kala **

1. Deptt. of F.R.M., College of Community Science, G.B. Pant University of Agriculture & Technology, Pantnagar, Distt. U. S Nagar, Utrakhnad- 263145.
2. Deptt. of F.R.M., College of Community Science, Dr. R.P.C.A.U., Pusa, Samastipur, Bihar. 848125

ABSTRACT

The role of women is crucial for the overall development i.e. nutritional, economic and educational upliftment of their family as now a days women economically contribute in their family income. In traditional India, most of the women were homebound but the scenario is gradually changing and now women had entered in almost all the field. They can prove the statement given by Jawahar Lal Nehru, the 1st Prime Minister of our nation i.e. “when a woman moves forward, the family moves, the village moves and the nation moves”. Women constitute one third of our country’s economically active population particularly in the unorganised sector specifically in the agrarian sector. (S.N Goswami, *et al.*). The employment opportunities in rural areas are low because of the fact that the agriculture is of seasonal in nature result in migration of rural people especially the women in other areas like microenterprise, small scale industries etc. for seeking their livelihood. women play an important role in the economic welfare of their family where lots of women are engaged in microenterprise for their livelihood security. In general women do all these activities just for household purpose, without keeping the financial bearing in mind. She manages household activities as well as enterprise activities properly. Besides women perform dual activities is of two folds- one on the domestic front and the other on the economic front.

This study was conducted in Muzaffarpur district of Bihar. Two microenterprises namely Papad Making Enterprise (PME) and Agarbatti Making Enterprise (AME), situated at Rambagh and Kalibadi road respectively. In this enterprise approximately 200 women were engaged. A fourty respondents were selected from each Papad Making Enterprise and Agarbatti Making Enterprise. Thus the total sample size was 80 respondents and applied interview method for getting studied.

In papad making enterprise appoximtely 130 women were engaged and I taken only 40 respondents for getting studied. In this enterprise women have lots of work related to enterprise and their home. The data pertaining to the involvement of women in papad making enterprise, indicated that maximum of respondents (62.5%) were involving for carry out ingredients by others i.e their family members, followed by 25 percent respondents were working herself and remaining 12.5 percent respondents were engaged with their husband. For dough making majority of respondents (75%) were involving by others and remaining 25 percent respondents were involving by herself. While a large number of respondents (50%) were using 1 to 3 hours for papad rolling followed by the women devoted 1 hour (37.5%) and remaining women devoted 3 to 6 hours (12.5%). As it in the other hand house hold activities a large number of respondents (37.5%) were giving 1-3 hours for cooking activity and remaining 26.5 percent were giving only 1 hour for it. The data related to washing cloth a maximum of respondents (50%) were devoting 1 hour for cleaning their cloth followed by the women (37.5%) were giving 1 to 3 and remaining women (12.5%) were giving 3 to 6 hours for it. A maximum of respondents (55%) were giving 1 hour for their child care followed by the 45 percent women used to give 1 to 3 hours and remaining 25 percent women were giving 3 to 6 hours for this. On personal care, majority of respondents (45%) were using 3 to 6 hours followed by the respondents (30%) used 1 to 3 hours and 25 percent respondents used to give only 1 hour for it. It was noted that f - value was significant and positive, hence it can be concluded that the women’s participation in time management practices in household activities influenced by the independent variables.

The findings of the study provide relevant information related with Socio- personal and psychological characteristics of selected women entrepreneur and their management practices needs. . In general women do all these activities just for

household purpose, without keeping the financial bearing in mind. She manages household activities as well as enterprise activities properly. Through this study identified management need of women in household and enterprise activity so that they can be able to make identity herself, economic empowerment, taking decision independently, and increase self confidence. Though, through microenterprises women can earn money for livelihood and improve their living standard of family members.

Key Words: Livelihood, Household, Microenterprise, Upliftment.

Exfoliative vaginal cytology and hormonal profile of malabari crossbred does during the oestrus cycle

UPASANA RATNAKARAN^{*1}, ARAVINDA GHOSH¹, K.N., METILDA JOSEPH¹, HIRON, M. HARSHAN¹, R. THIRUPATHY VENKATACHALAPATHY², AND V. RAMNATH³

¹*Department of Animal Reproduction, Gynaecology and Obstetrics*

²*Department of Animal Genetics and Breeding*

³*Department of Veterinary Physiology*

College of Veterinary and Animal Sciences, Mannuthy, Kerala

ABSTRACT

The present study was conducted with the objective to determine the hormonal profile and vaginal cell pattern during various stages of oestrus cycle of Malabari crossbred does. A total of 20 healthy does with an average body weight of 25-30 kg, aged 2-4 years with an oestrus length of 18-21 days were selected for the study. The experiment was started from the day of oestrus (day 0) and vaginal smears were collected on the day of oestrus (day 0), day 3, day 10 and day 21 of the oestrus cycle. The serum estradiol levels were estimated on day 0 and progesterone levels were estimated on day 0, 10 and day 21 of the cycle. The vaginal smears were taken from each animal using a sterilized cotton swab from the anterior wall of the vagina. The collected samples were stained with Leishman's stain and observed microscopically. Oestradiol and progesterone levels in the blood serum were analyzed by enzyme linked immunosorbent assay (ELISA). The results from the present study showed that the proportion of vaginal cells were significantly different in each phases of the estrus cycle. The proportion of superficial and nucleated cells were found to be significantly higher during the oestrus phase (day 0). During the metestrus phase (day 3), presence of metestral cells along with large number of neutrophils and intermediate cells were observed. In the diestrus phase (day 10), the presence of only intermediate cells were found throughout the cycle; whereas during the proestrus phase (day 21), the presence of parabasal cells were significantly higher along with the intermediate cells. With regard to the hormonal profile, the concentration of oestradiol and progesterone during oestrus were 11.00 ± 3.51 pg/ml and 0.43 ± 0.19 ng/ml respectively. The progesterone concentration on day 10 and day 21 of the cycle were 4.48 ± 0.79 ng/ml and 0.56 ± 0.23 ng/ml respectively. Hence, it can be concluded that the study of exfoliative vaginal cytology and serum hormonal profile can be used as a tools for oestrus detection and to confirm the stage of oestrus cycle which could be used as a guide for proper timing of insemination as well as for improved conception rate in goats.

Key Words: *Exfoliative Vaginal cytology; Oestradiol; Progesterone; Malabari crossbred does; Oestrus cycle;*

Impact of climate change on Agriculture and its mitigation strategies: A Review

Mehnaz Aijaz and Eyram Hamid

Department of Botany, Glocal University, Saharanpur-247121(U.P.)

ABSTRACT

A change in the long-term weather patterns that characterise the world's regions is referred to as global climate change. Climate change poses a serious threat to the world's food and nutritional security. Because of the greenhouse effect, as greenhouse-gas emissions in the atmosphere rise, the temperature rises as well. Climate change could have a variety of effects on agriculture, including crop quantity and quality in terms of productivity, growth rates, photosynthesis and transpiration rates, moisture availability, and so on. Climate change is projected to have a direct impact on global food production. An increase in the mean seasonal temperature can shorten the growing season of many crops, reducing

3rd International Conference on “Global Initiative in Agricultural, Forestry and Applied Sciences for Food Security, Environmental Safety and Sustainable Development (GIAFAS-2021)”

production. Climate change drivers, such as changes in air composition, can have an impact on food production through affecting plant physiology. Climate change has an impact on the microbial population in soil, as well as their enzymatic activities. Agriculture's contribution to climate change, as well as climate change's negative influence on agriculture, has serious consequences that are expected to have a significant impact on food production and may jeopardise food security, necessitating special agricultural policies to resist. This paper examines the data gathered from the literature on climate change, its possible causes, its near-term projections, its impact on the agriculture sector as a result of its influence on plant physiological and metabolic activities, and its potential and reported implications for plant growth and productivity, pest infestation, and mitigation strategies and their implementation.

Keywords: Climate change, nutritional security, Greenhouse effect, Greenhouse gases (GHGs), Agriculture, Food production, Pest infestation

Design and development of farmer’s participatory newsletter on honey production in Nainital district of Uttarakhand.

Aafreen Malik¹ and Amardeep²

*Department of Agricultural Communication,
College of Agriculture, GBPUA&T, Pantnagar, Uttarakhand, India*

ABSTRACT

Communication has been identified as a crucial catalyst in agriculture as well as rural development. Communication plays important role in catering the information need of beekeepers regarding honey production. In addition to various traditional media, modern communication media are growing which envisages new hope to support developmental activities. Though modern mass media has wide reach but high mass media exposure does not guarantee catering of basic information needs of beekeepers regarding honey production. Print media is declared as most-used medium for agriculture development purposes but is also does not cater the actual information needs at grass root level. Therefore participatory communication approach newsletter appears as an alternative of beekeepers development. The study was conducted in Bhimtal block of Nainital district of Uttarakhand, which selected purposively. One village jeoli was selected purposively from Bhimtal block. Total 75 respondents were selected purposively. The data was collected by structured interview, personal observation, focused group discussion and knowledge test administered as pre and post newsletter distribution and appropriate statistical procedure were employed to analyze the data. Newsletter were design and developed by the preferences and participation of respondents in whole process such as size of newsletter, design of newsletter, content and name of newsletter, information need of respondents regarding honey production and overall look of newsletter.

Key words: Communication, honey production, newsletter, print media, participatory communication

Genebank Genomics

Chaw Su Su Htwe

Division of Plant Genetic Resources, ICAR-IARI, New Delhi, 110012

ABSTRACT

Preserving plant genetic resources for future crop improvement is the long-term mission of Genebanks, however, the utility of these genetic resources has been poor as there is a lack of effective means for the discovery and transfer of beneficial alleles from landraces and wild relatives into modern varieties. Molecular passport data derived from genomic sequence information are become efficient for genebank management for large collections and can be used to complement, corroborate and correct traditional passport records and, together with recent advances in breeding methodologies, will facilitate the selection of useful genetic variation and easy access to existing crop diversity (Mascher et al., 2019). Muñoz-Amatriaín et al. (2014) used a barley SNP iSelect platform by using 2,417 barley core accessions demonstrated the utility of the core collection for locating genetic factors determining important phenotypes

3rd International Conference on “Global Initiative in Agricultural, Forestry and Applied Sciences for Food Security, Environmental Safety and Sustainable Development (GIAFAS-2021)”

by Genome-wide association studies (GWAS) and high-density SNP genotyping. (Singh et al., 2019) presented a pipeline to identify and remove identical accessions within and among genebanks and curate globally unique accessions by using cost effective and efficient management methods, such as Genotyping by Sequencing (GBS). Milner et al. (2019) provided insights into the global population structure of domesticated barley and pointed out redundancies and coverage gaps from the analysis of genome-wide genotyping-by-sequencing data for almost all barley accessions (22626) of the German *ex situ* genebank and it can also be detected known and novel loci underlying morphological traits differentiating barley gene pools. They also found evidence for convergent selection for barbless awns in barley and rice and shown that a major-effect resistance locus conferring resistance to bymovirus infection has been favored by traditional farmers by GWAS. These studies demonstrated that high-density genotyping and GWAS are effective tools in identifying genetic variation in large germplasm collections. GBS data in combination with phenotypic data are a permanent resource for investigating the genes underlying crop evolution and selection for agronomic traits. There is a need for strong engagement of curators, geneticists and/or breeders and bioinformaticists in a proactive planning process to develop a flexible set of best practices and strategies and will facilitate better use of germplasms for future crop improvement programme.

Survey report on crop losses due to late blight disease in potato

Ekta Pandey¹, and Medha Pandey²

1, Department of Agricultural Statistics, A.N.D.U.A&T Kumarganj – Ayodhya (UP), 224229

2, Department of Agronomy Integral University - Lucknow (UP)

ABSTRACT

In the states of Punjab, Haryana, Uttar Pradesh, Maharashtra, Bihar, West Bengal, and Karnataka, late blight caused by *Phytophthora infestans* destroyed potato crops early in the season in 2006-07. In Punjab, almost the whole potato crop was afflicted to varied degrees, whereas the illness was recorded from specific regions in other parts of the country. Hoshiapur district in Punjab suffered the maximum damage (36 percent loss), followed by Kapurthala (27 percent loss), Jalandhar, and Patiala (24 percent loss each). The state's overall cumulative loss was 349,860 t. In Haryana, overall production fell by 8.8%, resulting in a crop loss of 40,260 tonnes. JP Nagar (56.1%), Rampur (31.2%), and Bijnor (31.2%) were the most affected districts in Uttar Pradesh, out of 18 districts (29.6 percent). Kanpur Dehat, Kannauj, and Farukhabad, the major potato-producing districts, experienced negligible crop loss (upto 1.1 percent). The state's total crop loss was anticipated to be 3.91 lakh tonnes. The districts of Pune and Satara in Maharashtra were the hit the hardest by the Rabi crop. The variety Atlantic had the most crop loss (68.3-72.3 percent), while Kufri Jyoti and Kufri Pukhraj suffered the least (5.1-9.3 percent). Crop losses in Bihar were greatest in Katihar and Purnea (50 percent each), followed by West Champaran (40 percent). The state's total crop loss was projected to be 4.95 lakh tonnes. Howrah, Burdwan, and Hooghly districts in West Bengal were the most hit (33.3 percent each), with a total loss of 28.04 lakh tonnes in the state. Hasan (48.3%), Chikmagalore (44.3%), and Belgaum (25.3%) were the most severely hit in Karnataka, with a total loss of 2.82 lakh tonnes. The country's total loss from late blight is projected to be 43.91 lakh tonnes.

Characterization of efficient biosurfactant producing bacterial isolates from the Yamuna River sediments

Zarreena Siddiqui and Abdul Malik

Department of Agricultural Microbiology, Aligarh Muslim University, Aligarh-202-002 (UP) India.

ABSTRACT

Pollution with petroleum hydrocarbons is far-reaching and thus, a problem for the environment as well as human health. The pristine environment has continuously been influenced by anthropogenic activities. Due to the globalisation of various industries; their waste materials are being discharged untreated or partially treated into the ecosystem and

3rd International Conference on “Global Initiative in Agricultural, Forestry and Applied Sciences for Food Security, Environmental Safety and Sustainable Development (GIAFAS-2021)”

have adverse impact on different life forms. Biosurfactants are extracellular amphiphilic, surface-active compounds produced by microorganisms. These microbially produced multifunctional biomolecules are versatile products and have vast applications in various aspects related to clean up of environmental contaminants inclusive of enhanced oil recovery (EOR), controlling oil spills, detoxification and biodegradation of oil-contaminated wastewater, soil or sediments. In the present work a total of 107 bacteria were isolated from Yamuna River sediments on minimal agar medium and screened for their biosurfactant production. 86.9% of the bacterial isolates showed haemolysis on blood agar medium, 66.3% showed oil displacement activity in the cell free culture broth. Emulsification assay revealed that 73.8% of the isolates displayed positive emulsification activity with diesel oil. Further, enhanced production of biosurfactant for the isolate Zar6 was optimized which revealed that temperature of 37 °C, pH 7 and 3% C:N ratio (Sucrose + Urea) were optimum conditions, and value of emulsification index increased from 31.8% to 90.9% after optimization. 16S rDNA sequencing was performed and Zar6 was found 100% similar to *Rhodococcus ruber*. The enhanced biosurfactant producing activity of bacteria in optimised condition may play significant role in degradation of petroleum hydrocarbons which suggests its future application in a microbial enhanced oil recovery process.

Key words: Biosurfactant, petroleum hydrocarbons pollution, Yamuna River, sediment.

Studies on the variation in quality traits of pickle prepared from aonla (*Emblica officinalis* Gaertn.) cultivars and their suitability for pickle preparation

Rajendra Kumar*

Amity Business School, Amity University Uttar Pradesh, Lucknow – 226 028 (U.P.) India.

ABSTRACT

Uttar Pradesh, is the leading state in production and acreage under aonla cultivation in the country. Generally, aonla is considered as “Wonder Fruit for the Health” because aonla fruits are highly nutritious and having good medicinal value but fruits are not consumed freely in fresh form because of its astringent taste due to fruit tannins. The study aims to analyze, various cultivars of aonla for their suitability into pickle preparation, which may become a popular processed product in comparison with other processed products. Accordingly, eight aonla cultivars viz - Banarasi, Chakaiya, Kanchan, Krishna, NA – 6, NA – 7, NA – 8, NA – 9 were evaluated. The recipe which has been found ideal for pickle preparation was used for screening of cultivars. Observations on vitamin 'C' (ascorbic acid), total soluble solids (T.S.S.), acidity, and browning were recorded at the monthly interval. The periodical organoleptic assessment of pickle was also performed during storage. The result reported gradual reduction in the organoleptic scores of the aonla pickle, during storage. The acceptable quality of aonla pickle was found to be up to nine months. The fruits of aonla cultivar NA- 7 were found most suitable for making quality pickle.

Key Words- Aonla, Processed, Products, Storage, Quality, Health, pickle.

A slippery model of sweet corn output and growth

Medha Pandey¹ and Ekta Pandey²

1, Department of Agronomy Integral University - Lucknow (UP), 226026

2, Department of Agricultural Statistics, A.N.D.U.A&T Kumarganj – Ayodhya (UP), 224229

ABSTARCT

A model is developed to aid in the predictions and interpretation of sweet maize (*Zea mays* L.) crop performance under optimal nutrient delivery. A discrete logistic equation with modifications for soil water deficiency is used to compute leaf area growth on the main stem and tillers separately (D). Leaf senescence is influenced by age and D. The efficiency of converting received radiation to biomass changes with D as well. The harvest index is assumed to vary linearly with thermal time when computing ear dry mass. The model was fitted using a dataset for crop reactions to D, tested against data for sowing date responses, recast using both datasets, and retested against growth measurements across a variety of plant populations. In terms of leaf area and biomass, the model performed admirably. Although regression of observed on simulated values yielded slopes not statistically different from 1, it was less effective for ear dry mass. The importance of future growth is highlighted.

Keywords: *Zea mays* L, crop model, leaf area, plant population, water stress

Recent advancements for energy production and sustainable environment in anaerobic digestion technology

P. S. Bandgar^a, Sudhir Jain^b and N. L. Panwar^c,

^{A,b,c} College of Technology and Engineering, Maharana Pratap University of Agriculture and Technology, Udaipur (RJ), India – 313001

ABSTRACT

Recent advances in a renewable biogas production process have resulted in the latest progress in using biogas as the alternative energy source to conventional sources of energy. Scientific efforts in the past decades have largely focused on improving and developing sustainable bioprocess solutions for energy recovery. As a low-price organic waste-treating technology with simple installation and relatively low capital and operational expenses, anaerobic digestion (AD) has been developed. These technologies have widely reported their viability and achievement and demonstrated the superiority of two-stage AD over single-stage AD as regards the total energy retrieval from biomass under various substrates and temperature levels, and in pH settings. However, co-digestions, electro co-digestion, various pre-treatments (physical, chemical, biological or combined), the addition of bio-based carbon materials, bioaugmentation have been applied to enhance the biogas production as per the various organic waste materials. Therefore, the selection of appropriate advanced technologies for particular biowaste gives better performance for biogas production. Furthermore, biogas contains undesirable components such as moisture, sulphide hydrogen (H₂S), carbon monoxide (CO) and carbon dioxide (CO₂). To remove these contaminants, different biogas upgrading processes have been developed such as water scrubbing, amine scrubbing, pressure swing adsorption and membrane division. And, separation of biogas digestate in solid and liquid through electro dialysis reversal and forward osmosis are attractive among membrane technology because of their high membrane trapping resistance. The information provided could help researchers to select the appropriate recent advances in AD technology to achieve the best results of biogas production and performance.

Keywords: Anaerobic digestion, biogas, recent technologies, digestate, sustainable development etc.

Elucidating the effect of Farmyard Manure and Zinc along with optimum dose of inorganic fertilizer on the productivity of rice (*Oryza sativa* L.)

Neelam Pankaj

Department of Plant Physiology, G.B.Pant University of Agriculture and Technology

ABSTRACT

The continuous use of chemical fertilizers for a long period of time deteriorates the nutrient status of soil. Even if balanced doses are used it leaves a residual effect for the next crops grown in the same arable land. This change in soil becomes more problematic for a vulnerable crop. In this regard a field experiment was carried out during Kharif season of 2010 and 2011. To study the effect of Farmyard Manure and Zinc along with optimum dose of NPK on the productivity of rice variety Pant Dhan 4. The studies so far reveal that the application of essential plant nutrients particularly macro and micronutrient in optimum quantity and right proportion is the key to increased and sustained crop production. An application of NPK with FYM and Zn proved to be superior in recording the highest number of tiller, panicle length, leaf area index, test weight and grain yield. This study demonstrates that the combined application of inorganic fertilizers and organic manures along with Zn has the potential to reduce chemical fertilizer usage without decreasing the yield of rice variety pant Dhan 4. In addition, excessive use of chemical fertilizers in agriculture has led to a variety of environmental problems and in the future fertilizers will be a major source of heavy metals and radionuclides accumulating as inorganic pollutants in plants.

Genetics and Epigenetics- role in development of Climate resilient crops

Piyusha Singh¹, Akanksha Tiwari¹, Vimlesh Kumar² and Alok Kumar Singh³

*1, Department of Genetics and Plant Breeding, 2 Department of Horticulture, 3 Department of Crop Physiology
College of Agriculture, ANDUAT UP INDIA*

ABSTRACT

Today's era recent advancements in the area of -omics of crops have facilitated effect on plant response to environmental stresses and identification of epigenetic marks. As climate change affects crop growth, so there is a need to develop climate resilient crop varieties. As germplasm plateau occurs in many crops so there is a need to examine genes from wild varieties, which are high yielding and resistant to climate change. As global warming occurs, temperature fluctuation rate is very high. To better adapt genetics and epigenetics transiently or lastingly to stimuli from the surrounding environment, the chromatin states in plant cells vary to allow the cells to fine tune their transcriptional profiles. Conceptually genetics deals with gene function and genes whereas epigenetics deals with gene regulations. Modifications in chromatin states include a wide range of histone post-transcriptional modifications, histone variants, DNA methylation and non-coding RNAs, which can arrange various chromatin states that epigenetically determine specific transcriptional outputs. Specifically genetics focuses on how DNA sequences change in the cell while epigenetics focuses on how DNA is regulated to achieve those changes. This has paved the way to exploitation of epigenetic variation in crop breeding. That helps to develop climate resilient crop varieties.

Key words: Omics Genetics and Epigenetics

Effect of fertilizer on growth and yield of bamboo (*Bambusa balcooa*) under rain fed condition

Aarti P Deshmukh, V. M. Ilorkar and P.D.Raut

AICRP on Agroforestry college of agriculture, Near Maharajbagh Nagpur 440012.(M.S.)India.

ABSTRACT

Field experiment on effect of different fertilizer on growth yield of *bambusa balcooa* under rain fed condition was carried out at agroforestry research farm, college of agriculture, Nagpur. Five levels of chemical fertilizer (50:15:25, 75:20:50, 100:25:75, 125:30:100 and 150:40:125 gm NPK per clum) along with control (0:0:0) were applied to the bamboo plantation planted in 2019. The growth and yield of bamboo species investigated from last two years it revealed that maximum plant height (4.03m) and girth of the clum (10.25cm) of *bambusa balcooa* was attained by the treatment, where, 100:25:75 gm. NPK per plant application was made. Maximum no. of tillers (5.63) was recorded in treatment in where 125:30:100 gm of NPK per clum applied. Maximum bamboo yield (75ton/ha) was recorded under 125:30:100gm of NPK per clum applied. Maximum clum volume per/ha (1.06) and carbon sequestration ton/ha (0.26) was recorded under application of 100:25:75 gm of NPK per clum.

Keywords : *bambusa balcooa, clum, agroforestry*

Production Potential of agricultural crops under citrus based Agroforestry systems in semi-arid region of Maharashtra.

Aarti P Deshmukh¹, Lalji Singh, V. M. Ilorkar and P.D.Raut

Department of Forestry, Indira Gandhi Krishi vishwavidyalya Raipur -492 012, Chhattisgarh, India.

AICRP on Agroforestry college of agriculture, Near Maharajbagh Nagpur 440012.(M.S.)India.

ABSTRACT

Traditional Agroforestry is very common in Vidarbha region of Maharashtra with forest tree crops. Now fruit tree crops are also introduced to increase the farmer's income. Hence, the experiment was conducted at AICRP on Agroforestry

3rd International Conference on “Global Initiative in Agricultural, Forestry and Applied Sciences for Food Security, Environmental Safety and Sustainable Development (GIAFAS-2021)”

research farm at College of Agriculture, Nagpur under citrus based agroforestry systems. The citrus fruit trees were planted at a distance of 6 x 6 m and forest species including *Tectona grandis*, *Eucalyptus teretocornis* and *Ailanthus excelsa* at equilateral distance of 3 meter in each treatment between two mandarin trees, where, cowpea crop (*Vigna unguiculata* var. Gomati and Pusa bold) was cultivated as traditional agri-horti-silviculture system during 2020-21. The growth performance and yield of cowpea and mustard under different set of treatments viz. T₁ (Sole cowpea and mustard), T₂ (Sole Mandarine + cowpea and mustard), T₃ (Mandarin + *Tectona grandis* + cowpea and mustard), T₄ (Mandarin + *Eucalyptus teretocornis* + cowpea and mustard) and T₅ (Mandarin + *Ailanthus excelsa* + cowpea and mustard) was recorded. The growth parameter and yield of cowpea and mustard crop was found maximum in open field crop (Sole cowpea and mustard) than the treatment under citrus based agroforestry systems and it was 25.57, 56.35, 44.00 and 63.12 per cent higher as compared to treatment T₂, T₃, T₄ and T₅, respectively. 17.46, 27.74, 23.08 and 33.85 percent higher in grain and 11.87, 21.78, 15.63 and 26.76. The grain and straw yield of cowpea and mustard was (5.75 and 10.31 and 11.38 and 20.48 q ha⁻¹ in crop of open field (Sole cowpea and mustard).

Key words : *Vigna unguiculata*, *Eucalyptus teretocornis*, *Tectona grandis*, Agroforestry systems.

Impact of zinc and boron in shelf life of vegetable crops (onion and tomato)

Tariq Ahmad Bhat^{1*}, A.M. Rather² and F.Mushtaq²

²*Division of Vegetable Science, Faculty of Horticulture, Sher-e-Kashmir University of Agricultural Sciences and Technology of Kashmir, Srinagar, Jammu and Kashmir, 190025*

ABSTARCT

Progressing urbanisation and shifting consumer preferences drive a replacement of rice by high-value vegetables, particularly in the peri-urban fringes, Associated changes in soil aeration status affect soil nutrient availability while particularly vegetables enhance the demand for the critically limiting micronutrients boron (B) and zinc (Zn). Experiments was carried out in onion and tomato for studying the effect of zinc and born on their shelf life and other quality parameters. Micronutrients like zinc and boron plays an important role in enhancing yield, quality and shelf of vegetable crops. Application of zinc @ 7.5 kg/ha and boron 1.5 kg/ha were found superior as compared to other treatments in increasing shelf of onion and lowest yield loss (67.95%) after storage of 45 days was observed. Application of 0.1% Borax + 0.2% Zinc Sulphate were found significantly in enhancing shelf life of tomato.

Key words: Micronutrient, onion, shelf life and tomato

Development and recent trends in IoT based food drying system: An overview

Nikita Mishra ^{*1}, Ashok Kumar ², S.K. Jain³, N.K. Jain⁴, N. Agrawal⁵

¹ *College of Technology and Engineering, Maharana Pratap University of Agriculture and Technology Udaipur, Rajasthan.*

² *College of Technology and Engineering, Maharana Pratap University of Agriculture and Technology Udaipur, Rajasthan.*

³ *Processing and Food Engineering Department, CTAE, MPUAT, Udaipur.*

⁴ *Processing and Food Engineering Department, CTAE, MPUAT, Udaipur.*

⁵ *Electronics and Communication Engineering Department, CTAE, MPUAT, Udaipur.*

ABSTRACT

India's diverse agro-climate ensures availability of all varieties of fresh fruits and vegetables. The agricultural production of the country has increased many folds in recent past and now our country is the second largest producers of fruits and vegetables. However, at the same time lack of awareness for post harvest technology and management, especially for perishable produces cause a great economic loss. Drying is one of the oldest method of food preservation, but still the control on the process parameters such as temperature and velocity of drying air and moisture content of product during drying is not possible through remote and continuous mentoring is required causing high cost of processing. With the development of information technology, the Internet of Things (IoT) has the characteristics use of action, and good comprehensive benefits. It promotes the development of the IoT technology in the monitoring and control of many process parameters of drying and value addition of food materials. This will not only improve the

overall quality of the produce by controlling the process parameters, but also reduce the cost of production/processing. The process parameters such as drying air temperature, temperature of food material in plenum chamber, velocity and relative humidity of air with monitoring and controlling of drying duration may help the future processors/entrepreneurs to have access to the input parameters through remote. This review is an attempt to explore different types of drying systems developed across the world on the basis of IoT. Further different thermal modelling, mathematical modelling and performance evaluation on the basis of drying curve have been discussed with experimental validation to give practical exposure to the researchers.

Synthesis and characterization of surfactant (CTAB/TSC/TX-100) assisted Ir & Sn mono/bimetallic nanoparticles and their application

Anjali Goel, Sudha Tomar*

Department of Chemistry, KGC, Gurukula Kangri (Deemed to be University), Haridwar, Uttarakhand, 249407, India

ABSTRACT

Nanotechnology encompasses the understanding, manipulation, and control of matter at the nano scale level obtained by a combination of engineering, physical, chemical, and biological approaches. It has enabled the development of advanced materials such as nanoparticles (NPs) and nanostructures with unique properties, including the novel optoelectronic, catalytic, and biological properties. Bimetallic NPs are definitely among the most widely studied systems in the modern nano science due to the fact that metals often have different properties when brought down to the nanometer dimensions. Bimetallic NPs are important due to their extremely small size, large surface-to-volume ratio and synergistic effect, which make them differ in properties from their native metals. At the nanoscale, the noble metal Iridium (Ir) reveals interesting catalytic, electronic, optical, mechanical, and magnetic properties like novel silver, gold, and platinum metals. Tin is a malleable post-transition metal that is not easily oxidized in the air. It can be coated onto other metals to prevent corrosion, favored nano catalyst with high surface activity, large specific surface area, good dispersion performance, and comparatively low cost. The present work is mainly focused on the synthesis and characterization of surfactant-assisted Ir-Sn BMNP (bimetallic nanoparticles) using modified polyol method. CTAB (Cetyltrimethylammonium bromide), TSC (Trisodium citrate), and TX-100 (Triton X-100) as cationic, anionic, and nonionic surfactants respectively are used to study their effect on the particle size, morphology and stability of Ir-Sn BMNP. For characterization of synthesized BMNP samples, several techniques including UV-vis spectroscopy, TEM, HR-TEM, FT-IR, XRD, XPS, FE-SEM, EDX/EDS, elemental mapping analysis, SAED, and thermal methods of analysis (TGA, DTG, and DTA) are used. The XRD patterns of all samples confirm that Ir-Sn BMNP samples are amorphous in nature. The FE-SEM and TEM images demonstrate that the particles of bimetal are in nano size, highly dispersed, and pseudo spherical in shape with smooth surfaces. The approximate crystallite (particle/grain) size of CTAB, TSC, and TX-100 assisted samples are ~1.39 nm (39 nm), ~2.2 nm (59 nm), and ~5.79 nm (89 nm) respectively. The presence and distribution of Ir and Sn elements in the BMNP is determined through EDAX and elemental mapping respectively. The XPS confirms the metallic state (Ir^0) of iridium; and the dual valence state of Sn (Sn^{2+} and Sn^{4+}) involving Sn 3d core level. The presence of a surfactant in the time of preparation of the nanoparticles not only prompts the nanoparticles to unfold highly active lattice surface, but also prompts the nanoparticles to have the feature of the ordered structure, large surface area, and abundant pores. These variations reform the physico-chemical properties of the nanoparticles, thereby raising the performance of the nanoparticles. Thus, this study may be helpful for the environmental purpose to improve the quality of wastewater of industries and many others.

Synthesis, characterization, and effect of cationic, anionic, and nonionic stabilizers on the particle size of Ir-Ni bimetallic nanocrystals

Anjali Goel and Shikha*

¹Department of Chemistry, KGC, Gurukula Kangri (Deemed to be University), Haridwar 249407, India

ABSTRACT

In recent years, there has been a continuous and growing interest among material's scientists for the synthesis and characterization of nanomaterials. Metals exhibit unique catalytic, magnetic, and optical properties when they are reduced to nanometer dimensions. The physical properties of metals at the nanoscale are different from that of the bulk and single atomic state. Nanomaterials have attracted enormous attention owing to their interesting properties as well as utility in the diverse areas including nanocatalysis, homogeneous catalysis, nanoelectronics, integrated catalysis etc.

3rd International Conference on “Global Initiative in Agricultural, Forestry and Applied Sciences for Food Security, Environmental Safety and Sustainable Development (GIAFAS-2021)”

Bimetallic nanoparticles have received tremendous attention in recent years. This is because nanocrystals composed of two metals, either in the form of homogeneous alloy or heterogeneous mixture have shown distinct and advantageous properties compared to their monometallic counterparts. Transition metal nanoparticles are attractive to use as catalyst due to their high surface to volume ratio as compared to bulk catalytic materials. Noble metals as Pt, Ir, Ru and Rh are excellent catalyst for many reactions but their limited reservoir and high cost restrict their use. The use of bimetallic nanoparticles may improve their activity and durability in addition to the possibility of reducing the loading of precious metals. Iridium is the part of platinum family and used as energizer due to its mercurial oxidation states. It is known as the most erosion resistant component even at temperature as high as 2000°C. Erosion and heat resistant peculiarities of iridium makes it much more lucrative element for alloying aspiration.

Nickel is the favored nanocatalyst for many reactions by virtue of its life, high activity, and its comparatively low cost. Specifically, the Ir-Ni system was described for hydrogen generation by electrocatalytic water splitting or by catalytic hydrazine decomposition as well as for catalytic hydrogen oxidation reactions and ring-opening reactions. In the present work Ir-Ni bimetallic nanoalloys were synthesized by modified polyol reduction method with different cationic, anionic and non-ionic surface active agents like CTAB (cetyltrimethylammonium bromide), SDS (sodium dodecyl sulphate), TSC (trisodium citrate) and PVP (polyvinylpyrrolidone) respectively. The synthesized bimetallic nanocrystals were characterized by UV-Vis, XRD, FTIR, FESEM, XPS, and HRTEM techniques. XRD and FTIR confirms the amorphous nature of synthesized bimetallic nanocrystals and the interaction between stabilizers and nanoparticles respectively. HRTEM studies reveal that the PVP stabilized Ir-Ni (3:1) and Ir-Ni (1:1) bimetallic nanocrystals are small in size and less dispersed as compared to CTAB, SDS, and TSC. Particle size of PVP assisted particles ranges from (1.77-2.36) nm while (10.1-246.2) nm for CTAB, TSC, and SDS supported nanoparticles. Thus non-ionic surface active agent PVP produced a better effect on nanoparticle size than cationic and anionic surfactants. These nanoparticles were further characterized by FESEM, EDX, and XPS methods of analysis. These results show that PVP supported nanoparticles are quasi spherical in shape and in core shell structure with Ni core and Ir shell and XPS confirms the oxidation state of Ir-Ni bimetallic nanoparticles. Thus, as-synthesized Ir-Ni/Surfactant supported bimetallic nanoparticles may provide a stable platform for the development of heterogeneous catalysis, green chemistry and environmentally benign protocol in the near future.

Impact of Climate Change on Migration

Minakshi Chakraborty

DGM-Rural & Agri Economist, Mahindra & Mahindra

ABSTARCT

The gradual change in the climate system resulting from both natural and artificial causes is a growing concern for the environmental activists and policy makers. ‘Climate change’ refers to the increasing changes in the measures of climate over a long period of time including precipitation, temperature, and wind patterns (EPA,2017). The most recent Intergovernmental Panel on Climate Change (IPCC) Report predicted that unless rapid actions are taken, there is more than 50% chance that the lower goal of the Paris Agreement (1.5⁰ C) will be exceeded by 2040 and 2⁰ C goal of the Paris Agreement will be exceeded by 2100.

The immediate and direct effects of climate change is the stress on water cycle. Increasing uncertainty of rainfall is becoming more frequent and this is likely to impact humanity in multiple ways. World Bank in its latest report on ‘Ebb and Flow’ highlighted how climate change is fuelling water induced migration. However, while people of the low-income strata get most affected by water cycle stress, they lack the means to migrate.

India’s status as a developing country mainly on agriculture makes it particularly susceptible to the effects of climate change. Like most other developing countries, India does not have adequate monitoring systems for the prediction of likelihood of occurrences of extreme events or the assessment of possible changes in weather patterns, thus, making the task of developing short term response or disaster management strategies extremely difficult.

Climate and climate change is a spatial phenomenon and hence climate change risk also varies spatially. The adverse impact of climate change is well known, yet large number of districts in India are vulnerable to any climate change risk. The intensity of climate change will only increase in future. The Indian Council of Agriculture Research (ICAR) released a report identifying the districts that are at high risk from climate change. The report states that 30% of the districts in India had regular occurrence of climate hazards. Gujarat and Punjab were the worst affected with majority of the districts under regular occurrence of climatic hazard. Haryana, Rajasthan, Uttar Pradesh, Tamil Nadu and West Bengal are the other states with high occurrence of climatic hazards.

3rd International Conference on “Global Initiative in Agricultural, Forestry and Applied Sciences for Food Security, Environmental Safety and Sustainable Development (GIAFAS-2021)”

There has been anecdotal evidence of how rural residents in drought prone districts of Marathwada migrate to the neighbouring areas, like, Mumbai, to seek employment in construction sector and live-in makeshift shacks. The extreme events of drought/flood damaging the agricultural income for the year will only increase going forward.

The key objective in this paper is to explore the extent of climate change induced migration and the work demand pressure that may develop in the neighbouring urban centres. Our analysis based on the National Sample Survey (NSS) on migrants:2007-08 suggests that short-term migrants are mainly from the lower consumption quintiles whereas the long-term migrants are generally from higher consumption quintiles. Thus, while climate change induced migration is likely to increase but the potential to settle in areas of high employment opportunities will only reduce. This paper reiterates the need to prioritise overall development in the identified highly vulnerable districts to climate change.

Trees as Sound Barriers

Dipali Chatse*, Dipmala Kedar, Ramakant Gajbhiye

Floriculture and Landscape Architecture, Section of Horticulture, College of Agriculture, Nagpur. Dr. Panjabrao Deshmukh Krishi Vidyapeeth, Akola, M.S.,

ABSTARCT

Noise pollution is the disturbing or excessive noise that may harm the activity or balance of human or animal life. The source of noise pollution is mainly caused by machines and transportation systems, motor vehicles, aircraft, trains and industrial Noise, construction Equipment, household Equipment etc. Noise pollution is very dangerous to both man and animals because it can cause many effect to their health and also to the environment. The threat of noise pollution needs to be taken seriously. For this, the first step is to make people aware with various diseases caused by noise pollution and sound pollution can reduced with the help of trees by the process of deflection, reflection and absorption. Trees such as Holly, Indian hawthorn, Abies, *Cryptomeria radicans*, cypress etc. Leafs are the most efficient parts of the trees for reflecting the noise. Larger leafs can reduce noise than smaller leafs. The rate of noise reduction will increased according to the increasing of tree length.

Keywords: Noise pollution, Trees

Traditional agricultural knowledge of tribes and resource based nutrient management interventions for the tribal farmlands of Madhya Pradesh

***Shinogi K.C., Sanjay Srivastava, Priya Gurav, Nishant Kumar Sinha, Bharat Prakash Meena, K. Bharati, Rameshwar Prasad Ahirwar, Hiranmoy Das and A.K Tripathi**

ICAR-Indian Institute of Soil Science, Bhopal, Madhya Pradesh

ABSTRACT

Indigenous Technical Knowledge (ITKs) in agriculture are agroecological innovations of primitive farmers, developed out of their experience in agriculture and knowledge in farming coupled with long term observation of the soil-plant-environment interrelations. The traditional-subsistence farming systems of tribal farmers living inside forest ecosystems are well known for the application of agriculture ITKs in conserving soil and water resources, nutrient management, and naturally controlling most of the pest and disease infestations. This study conducted in the tribal rice-fallow systems located in the south-Balaghat forest division of Balaghat district in Madhya Pradesh has documented terracing of steep slopes, fragmentation of terraces using earthen bunds with water inflow-outflow system, water harvesting ponds at the down hills as the major land management practices of the tribal farmers. The major sources of plant nutrients in these farmlands are farmyard manure and forest leaf litter reaching to the farmlands through runoff water. Though these farmers adopted hybrid rice (MTU 1010 with an average yield of 4.0-4.5 t/ha), average crop yield is in the range of 2.5-3.0 t/ha. Analysis of soil samples revealed soils of these tribal agroecosystem have severe deficiency of Boron (B), an essential micro nutrient for the healthy growth of rice crop, with sufficient availability of primary, secondary and other micro nutrient elements. Water availability in these flooded rice systems is good as depth of water table in floating water bodies as well as open wells is sufficiently high throughout the year. In order to enhance and sustain crop yield from these subsistence farming systems integration of economically and ecologically compatible agricultural technologies are

3rd International Conference on “Global Initiative in Agricultural, Forestry and Applied Sciences for Food Security, Environmental Safety and Sustainable Development (GIAFAS-2021)”

necessary. Considering the availability of on-farm resources and soil characteristics it is identified that integration of nutrient management technologies like leaf compost, green leaf manures, azolla, steamed bone meal would improve the soil health and crop yield of the tribal rice-fallow systems. That in turn would ensure food and nutrient security of tribal hamlets along with generating marketable surplus enough to earn more from agriculture.

Acute toxicity of Silica oxide nanoparticles on Indian Major carp *Labeo rohita* fingerlings

Ujjwala Upreti and Avdesh Kumar,

Department of Aquaculture, College of Fisheries, G.B.P.U.A. & T Pantnagar

ABSTRACT

The fate and result of nanomaterials within the surroundings has raised concern concerning their environmental risk to aquatic organisms. Silica nanoparticles (SiO₂-NPs) have wide applications in diverse fields such as medicine, cosmetics, engineering etc and are unavoidably released into the environment. However, the ecotoxicological effects of SiO₂-NPs on the freshwater fish remain out of action. The aim of this study was to analyse the lethal concentration of Silica oxide nanoparticles in the freshwater fish *Labeo rohita* fingerlings. The fish was exposed to sub lethal concentration of SiO₂-NPs and haematological parameters were recorded. Red blood cells (RBC), White blood cells (WBC), Haemoglobin and Mean corpuscular haemoglobin concentration (MCHC) were altered in SiO₂-NPs exposed fish. The outcome of the present study suggest that the alterations of these parameters may relate to physiological stress system to SiO₂-NPs toxicity and furthermore expose that manufactured metal oxide NPs shall affect the health condition of organisms in the aquatic environment.

Keywords: LC₅₀, Hematology, SiO₂NPs

Development and Assessment of Small Scale Mechanized Groundnut Decorticator

Geeta Chitagubbi, Rajeshwari Desai and Shobha Kasar

*AICRP-HSc (FRM) & Unit Coordinator, AICRP-HSc * AICRP-HSc (FRM)***

All India Coordinated Research Project-Home Science (Family Resource Management) Main Agricultural Research Station, University of Agricultural Sciences Dharwad 580005 Karnataka, India

ABSTRACT

Groundnut is the sixth most important oilseed crop in the world. Groundnut is a valuable source of edible oil (43-55%) and protein (25-28%) for human beings, and fodder for livestock. Groundnut decortication is one of the drudgery prone post harvest activity and women are the major labour force. In the remote areas, shelling & decortication of groundnut is difficult due to shortage of laborers and high labour wages and women are the major labour force. In traditional method, decortication is done manually by hands. Many manual groundnut decorticators are available, though the work output of these high but women experiences high energy demand and more drudgery with the use of these decorticators. Hence with the intension of reduction of drudgery, labour cost & to enhance the profit for small and marginal farming community. All India Coordinated Research Project on Home Science (Family Resource Management component), UAS, Dharwad has developed Small scale mechanized Groundnut decorticator and assessed at the field level. Thirty non-pregnant farm women with normal health, and without any major illness or cardio-vascular problems, falling in the age range of 25- 45 years were selected for the study. The results showed that the machine was safe and easy to operate. It also proved the excellence in work output with an average decortication rate of 15 Q/day, reduction of Man days (0.07 No./Q) and the cost of operation (111 Rs. / Q) was observed as compared with other models and traditional method of decortication. The farm women perceived that the work was easy & light and experienced less drudgery while working with this small scale mechanized decorticator. Hence, such small mechanized farm tool proved to be appropriate for small and marginal farming community as they are drudgery reducing and cost effective technology

Keywords: Drudgery, groundnut decorticator, work out put, Cost of Operation and Man days

An interventional analysis on drudgery reduction technologies for empowerment of farm women

Geeta Chitagubbi* Rajeshwari Desai **and Shobha Kasar***

*AICRP-HSc (FRM) & Unit Coordinator, AICRP-HSc * Junior Scientist, AICRP-HSc (FRM)** and All India Coordinated Research Project-Home Science (Family Resource Management) Main Agricultural Research Station, University of Agricultural Sciences Dharwad 580005 Karnataka, India*

ABSTRACT

Most of the vegetable production system activities are performed by women except land preparation and irrigation. They are still performing these activities in traditional manner using conventional tools. Majority of women performs weeding activity in squatting posture for long time which is very uncomfortable posture leads to lower back pain. Weeding and top dressing of fertilizer activities are women dominated and are performed in uncomfortable posture leading to musculo-Skeletal disorders and drudgery of farm women. Hence, the study was conducted with an objective of Intervention of drudgery reducing technologies in vegetable production system for empowerment of farm women. The study was carried out in the Mulamuttala, Garaga and Lokur villages from Dharwad district of Karnataka state with the sample size of 30 farm women and ten farm women for ergonomic analysis. The data was collected by survey and experimental methods. The results revealed that the work efficiency with the use of cycle weeder showed significant increase in Pace of Work (30.83 hr/acre) and saved the labour cost of Rs 1190/- as compared to traditional method of weeding (76.25 hr/acre). The use of fertilizer trolley for top dressing of fertilizer application activity in vegetable production system showed significant increase in Pace of Work (20 hr/acre), the reduction of drudgery and postural discomfort was observed and use of these technologies helps in saving of time and energy among farm women in vegetable production system and were highly appreciated and accepted by the small farming community. Thus they proved to be appropriate technologies for the farming community.

Key words: Vegetable production, Drudgery, work out put and Cost of Operation

Performance of maize (*Zea mays*) as influenced by drip irrigation schedules and nitrogen levels

Y. Deepthi Kiran, V. Sumathi and G. Prabhakara Reddy

Department of Agronomy, S.V.Agricultural College, Tirupati-517 502, Andhra Pradesh

ABSTRACT

Field experiments were conducted over two consecutive years (2013-14 and 2014-15) at S. V. Agricultural College, Tirupati, Andhra Pradesh to study the growth and yield of maize under different irrigation schedules and nitrogen levels. The experiment was laid out in split plot design, replicated thrice by taking four irrigation schedules as main plots and three nitrogen levels as sub plots. The growth parameters of maize viz., plant height, leaf area index and total dry matter production were considerably influenced by irrigation schedules and nitrogen levels. With respect to interaction, irrigation schedules and nitrogen levels exerted significant influence on all the growth parameters at all stages of sampling except at 30 DAS. Higher yield of maize was obtained with weekly check basin irrigation, which was on par with drip irrigation at 0.9 IW/CPE ratio. Among the nitrogen levels tried, the highest yield was obtained with 240 kg N ha⁻¹. The interaction between the irrigation schedules and nitrogen levels indicated that higher yield was found with scheduling irrigation either by weekly check basin method or by drip irrigation at 0.9 IW/CPE ratio along with 240 kg N ha⁻¹. The experimental findings revealed that maize can be grown economically with limited water supply at 0.9 IW/CPE ratio through drip irrigation along with 240 kg N ha⁻¹.

Molecular identification and characterization of *Banana bunchy top virus* from Uttar Pradesh, India.

Deepak Panwar, D. Pratap*

Virology lab, Dept of Genetics and Plant Breeding C.C.S University Meerut-250004

ABSTRACT

Banana bunchy top disease is one of the most devastating viral diseases of banana (*Musa* spp.) in India. The disease is caused by *Banana bunchy top virus* (BBTV) belong to genus *Babuvirus* and family *Nanoviridae*. BBTV carries hexapartite genome with circular single-stranded DNA each approximately 1 Kb in size. From 2018 to 2020, a

3rd International Conference on “Global Initiative in Agricultural, Forestry and Applied Sciences for Food Security, Environmental Safety and Sustainable Development (GIAFAS-2021)”

collection of field surveys were conducted in the major banana growing regions in and around Lakhimpur and Meerut District of Uttar Pradesh to study the seriousness of the bunchy top disease. The Infected leaf samples were showing dark green streaks in the leaf veins, which later on resulting in dwarfing of leaves and stunting of the plants and show bunchy top appearance. For molecular identification and characterization, the total genomic DNA was isolated through modified CTAB technique from the leaf samples of infected and healthy (negative control) banana plants. For the initial identification, the genomic DNAs were subjected to PCR that give an amplification of ~170 bp with diagnostic primers, ~500 bp with coat protein (CP) primers and ~375 bp with partial rep gene in the infected samples and no amplification in healthy control. For the complete molecular characterization, primers were designed for each six genomic components with aid of BBTV sequences available on NCBI GenBank data. All the six genomic components were successfully amplified with respective primers from all three different DNA samples. The amplicons achieved were of approximately DNA- R ~1110 bp, DNA U3~1050bp, DNA- S~1058bp, DNA- M~ 1050bp, DNA- C~1000bp, DNA- N~1110. The PCR products were gel purified and directly send for sequencing. The initial bioinformatics analyses with NCBI - BLAST showed 97.35 % similarity with the BBTV strains from Rwanda and belong to African grouped. This is the first report of the existence of BBTV African group in India.

Antibiotic Resistance in Foodborne Pathogens in Milk in Lucknow District of Uttar Pradesh (India)

Shruti Mishra*

** Department of Basic and Applied Sciences, National Institute of Food Technology Entrepreneurship and Management, Sonapat, Haryana, India*

ABSTRACT

Milk is considered as complete food which meet almost all nutritional requirements of humans. Raw or unprocessed milk provides the most suitable substrate for the growth of wide variety of microorganisms. The present study was undertaken to investigate the microbial contamination (*Escherichia coli*, *Salmonella* and *Staphylococcus*) and their antibiotic resistance in raw and pasteurized milk. Raw and pasteurized milk were collected from the local market of Lucknow district of Uttar Pradesh. Disk diffusion method was employed to detect the antibiotic resistance using five antibiotics viz., ampicillin, chloramphenicol, ciprofloxacin, streptomycin and tetracycline. Raw milk was found to be mostly contaminated with foodborne pathogens of which, many were antibiotic-resistant. The prevalence of antibiotic resistance was determined as resistant, intermediate and susceptible. Among the tested samples, *E. coli* and *Salmonella* were found to be resistant towards maximum antibiotics used. *Staphylococcus* was found to be resistant towards ampicillin and tetracycline. The observations provided an insight for assessing the possible health risk posed to the consumers, which has significant public health impact.

Keywords: Milk, Antibiotic resistance, Foodborne pathogens, Food safety, Public health

Studies on genetic variability, heritability and genetic advance for various yield attributing traits in chickpea (*Cicer arietinum* L.)

Karthikeyan M*, Sharad Pandey, Gideon Synrem** and Vivek Singh ****

** Department of GPB, Annamalai University, Chidambaram, Tamil Nadu*

***Department of Agriculture, Himgiri Zee University, Dehradun (Uttarakhand)*

ABSTRACT

An experiment was conducted with twenty genotypes of chickpea (*Cicer arietinum* L.) to examine the presence of genetic variability which may further be utilized in breeding program. The experimental material was laid out in randomized block design with three replications at the experimental field of Himgiri Zee University, Dehradun during 2019-2020. Analysis of variance revealed that genotypes possessed significant genetic variability among all traits. The experimental results showed that the phenotypic coefficient of variation values were slightly higher than the genotypic coefficient of variation (GCV) values indicating the variation is not only due to genotype but also due to favorable

3rd International Conference on “Global Initiative in Agricultural, Forestry and Applied Sciences for Food Security, Environmental Safety and Sustainable Development (GIAFAS-2021)”

influence of the environment. The high estimates of genotypic coefficient of variation (GCV) and phenotypic coefficient of variation (PCV) were observed for 100 seed weight (81.14, 83.25) respectively, followed by seed yield per plant (24.93, 25.10), number of primary branches (23.78, 23.96) and number of pods per plant (20.91, 21.11). High heritability (h^2) coupled with high genetic advance as percent of mean (GAM) were observed for the traits seed yield per plant, number of pods per plant, number of primary branches, number of secondary branches, 100 seed weight, plant height and protein content indicating that the heritability may be due to additive gene effects and selection may be effective for crop improvement.

Key words: Chickpea, genotypic coefficient of variation (GCV), phenotypic coefficient of variation (PCV), heritability, genetic gain, protein content and additive gene effects.

Doubled Haploid Technology: Tool for Crop Improvement

Anju Nehra^{*}, Dr S S Poonia¹, Dr M L Jakhar², Dr D K Gothwal³, Manisha Shivran⁴

Department of Plant Breeding and Genetics, S.K.N. Agriculture University Jobner, Jaipur 303328 (Rajasthan)

ABSTRACT

Plant tissue culture techniques are recognized as useful instruments in crop improvement. Among these haploid technology is one in which haploid embryos are regenerated from male and female gametes for the production of haploid and double haploid plants who are homozygous in origin. In this technique, in vitro anther culture stands out and is an increasingly powerful tool when integrated with breeding programs as it results in pure lines. Plant tissue culture techniques are recognized as useful instruments in crop improvement. Among these haploid technology is one in which haploid embryos are regenerated from male and female gametes for the production of haploid and double haploid plants who are homozygous in origin. In this technique, in vitro anther culture stands out and is an increasingly powerful tool when integrated with breeding programs as it results in pure lines. Double Haploids useful for like as development of homozygous lines, Fixation of heterosis, Mutation studies and easy to induce mutation. Production of biotic and abiotic stress, resistant plants, Cytogenetically research, Induction of genetic variability at haploid level, Double haploids in genome mapping, Evolutionary studies. The successes of double haploid production rely on different factors like flower parts development stage, culture media, genotypes, donor parent growth condition and haploid detection methods. The technology able shortens breeding cycle or time, complete genetic purity, efficient in genetic study, marker development, mutation and transformation better than traditional way of breeding. Generally, understanding DH technology has important contribution in accelerating breeding program for immediate reaction towards out breaking biotic and abiotic constraints and competitive to world market.

Keywords: haploid, Double haploid, heterosis, purelines, crop improvement

Melissopalynology of honey samples during major and minor honey flow periods of Kodagu district, Karnataka

C N Nidhi^{*}, R N Kencharaddi

Department of Entomology, University of Agricultural and Horticultural Sciences, Shivamogga, Karnataka, India

ABSTRACT

The investigation entitled “Melissopalynology of honey samples during major and minor honey flow periods of Kodagu District, Karnataka” with the objective to carry out melissopalynological studies on honey was carried out from Kodagu from June 2019 to May 2020. The melissopalynological studies were carried out by collecting honey samples from two seasons from all four ecosystems. The samples were analyzed for the quantitative and qualitative parameters such as Absolute Pollen Concentration (APC), pollen density and diversity by following the techniques suggested by Erdtman (1953). Of the eight honey samples collected in two different periods of floral availability, five were unifloral and three multifloral. During November – December, the predominant pollen sources were *Tabebuia sp.*, *Sapindus laurifolius* and *Alternanthera sessilis* in semi-evergreen, moist deciduous and dry deciduous ecosystems respectively. During March - April, *Cocos nucifera* and *Taraxacum sp.* were the predominant pollen sources in semi-evergreen and dry deciduous ecosystems. The honey samples belonged to the Louveaux classes of either III or IV, indicating moderately highest Absolute Pollen Concentration. The highest number of pollen sources in honey samples of November-December was in

3rd International Conference on “Global Initiative in Agricultural, Forestry and Applied Sciences for Food Security, Environmental Safety and Sustainable Development (GIAFAS-2021)”

the evergreen forest followed by semi-evergreen, moist deciduous and dry deciduous ecosystems. Whereas, in respect of honey samples of March- April, it was highest in semi-evergreen followed by evergreen, dry deciduous and moist deciduous ecosystems.

Keywords: melissopalynology, pollen density, diversity, unifloral, multifloral

Biological control: an important tool of IPM

Mohammad Faisal and Sharad Pandey

School of Agriculture, Forestry & Fisheries Himgiri Zee University, Dehradun (UK), INDIA

ABSTRACT

Biological control is the reduction of pest population including insects, weeds and diseases by natural enemies. Natural enemies used in biocontrol measures include parasitoids, predators, microbes and nematodes. Insect pest plays a significant role limits crop production. For their control, most of the farmers are using chemical pesticides. The widely used chemical insecticides cause harm to humans and the environment. Several studies have proved that the use of chemicals are decreasing environmental quality, threatening biodiversity and increasing the incidences of pest outbreaks. Bio control agents are generally safe to plants, animals, humans and the environment. Biological control schemes operate throughout the world as part of the management of pests in agriculture and forestry. The farming system with greater reliance on biological control of insect pests increases the sustainability of agroecosystems.

In view of above, a concept of integrated pest management (IPM) has been developed based upon an understanding of agro ecosystem ecology and integration of various control tactics into pest management systems. IPM is a tactic of pest management including monitoring of insect populations, cultural, mechanical, biological and chemical methods of insect-pest's management. In all several IPM tactics, biological control is one of most useful technique that discourage the development of populations of harmful organisms.

The manipulation of beneficial organisms or natural enemies remains a very important tool in IPM program of insect-pests all over the world. Biological control of pest is the non-chemical way of killing pest which is environmentally friendly. In the present time, biological control has become an effective, environmentally non-degrading, technically appropriate, economically viable and socially acceptable method of pest management.

Keywords: Biological control, IPM, Predator, Parasites

Biofortification: A Sustainable Agricultural Strategy For Reducing Malnutrition

Swati Kumari¹ and Ritu Kumari²

¹Department of Agronomy, Bihar Agricultural University, Sabour, Bhagalpur- 813210, Bihar

²Department of pathology, RPCAU ,Samastipur ,Bihar

ABSTRACT

Micronutrients are not only important for better crop productivity, but also essential for sustaining human and animal health. There is a widespread deficiency of zinc in the Indian soils. Micronutrient malnutrition is known to affect more than half of the world's population and considered to be among the most serious global challenges to mankind. Malnutrition is of great public health significance in several parts of the world, especially the developing and underdeveloped countries. Deficiency of minerals such as Fe and Zn can cause various severe health issues. Low Zn levels lead to stunted growth and immune dysfunction (Sauer et al. 2016). Modern plant breeding has been historically oriented towards achieving high agronomic yields rather than nutritional quality, and other efforts related to alleviating the problem have been primarily through industrial fortification or pharmaceutical supplementation. Micronutrient deficiencies in humans can be mitigated through the process biofortification. Biofortification is a promising and sustainable agriculture-based strategy to minimize Zn and Fe deficiency in dietary food substances (Vasconcelos et al. 2017). Foliar fertilization with micronutrients often stimulates more nutrient uptake and efficient allocation in the edible plant parts than soil fertilization, especially with cereals (Lawson et al. 2015). The combination of soil and foliar application is often the most effective method in rice (Phattarakul et al. 2012). Agronomic bio-fortification could be a rapid solution to enrich the food crops and reduce micronutrient malnutrition in humans. The time of achieving and broader adoption by all sorts of farming community and feasibility of agronomic biofortification gains momentum.

Relative performance of wheat (*triticum aestivum*) varieties under different residue management and tillage systems

KAPIL MALIK^{1,*}, O. P. LATHWAL¹, A. K. DHAKA¹, ABHILASH² and PANKAJ DAH IYA²

¹Department of Agronomy, CCS Haryana Agricultural University, Hisar, Haryana

²Department of Agricultural Meteorology, CCS Haryana Agricultural University, Hisar, Haryana

ABSTRACT

Two year experiment was conducted at research farm of college of agriculture, Kaul, CCS Haryana Agricultural University, Hisar during *rabi* seasons of 2017-18 and 2018-19 to examine the performance of wheat varieties under various residue management practices and tillage systems. The investigation was carried out in strip plot design (SPD) with three replications keeping sowing methods in main plots and varieties in subplots. Six wheat varieties namely HD 3086, HD 2967, WH 1105, WH 1124, WH 711, and WH 1142 were grown under four sowing methods such as wheat sown with turbo seeder with full residue retention, wheat sown with turbo seeder with intact rice residue, wheat sown with zero till seed cum fertilizer drill with no residue, and wheat sown in conventional tillage conditions with no residue. Results of the experiment had shown that among different wheat varieties, HD 3086 recorded maximum seed, straw and biological yield which was significantly higher than rest of varieties but statistically at par WH 1105 and HD 2967 varieties. Among sowing methods, growth of wheat crop was improved under turbo seeder with full residue retention sowing method, and recorded significantly higher seed, straw and biological yield as compared to wheat sown in conventional tillage conditions with no residue. Therefore, it is concluded that different residue management and tillage systems have more influence on the performance and productivity of different varietal genotypes of wheat.

Keywords: *Wheat Yield, Performance, Tillage System, Residue, Varieties, Productivity*

Foraging Behaviour of *Apis mellifera* L. on Onion, *Allium cepa* L. bloom

Neeraj Kumar and G.S. Giri

Department of Entomology, TCA, Dholi, Muzaffarpur, Bihar-843121, India

ABSTRACT

The experiments on “Foraging Behaviour of *Apis mellifera* L. on Onion, *Allium cepa* L. bloom” were carried out during the year 2019 at ELP Apiary, TCA, Dholi. Objectives of this investigation were to study the, foraging behaviour of *Apis mellifera* on onion. The result on foraging behaviour of *Apis mellifera* revealed that they started visiting onion flowers in early morning and ceased their activity later in the evening. It remained active throughout the flowering period. The foraging rate of *Apis mellifera* was minimum in afternoon (11.6 flowers/min) and maximum during evening (24.3 flowers/min) and its foraging speed was maximum in afternoon (12.1 sec) and minimum in evening (6.5 sec) and there was inverse relation between foraging rate and speed. The heaviest pollen load was carried by the *Apis mellifera* in afternoon which indicated that more pollens were collected by *Apis mellifera* during afternoon from onion flowers. The result depicts that insect pollinators provide an important pollination service to the onion seed production. Among different insect pollinators, *Apis mellifera* was found most efficient pollinator of onion. Utilization of *Apis mellifera* bee colonies for seed production in onion will be highly remunerative as due to pollination, higher quantity of quality seed is produced.

Key Words: Foraging Behaviour, Foraging Rate, Foraging Speed, Onion

PARTICIPATORY APPROACH IN ADOPTION OF FODDER CULTIVATION TECHNOLOGY TOWARDS INCREASE IN MILK PRODUCTION IN GARHWA DISTRICT OF JHARKHAND

Sushma Lalita Baxla¹, Ashok Kumar¹, Pankaj Seth², Sudhir Kumar Jha¹, and Sunita Kumari Kamal³

¹Krishi Vigyan Kendra, Garhwa, Birsa Agricultural University, Ranchi- 824006 (Jharkhand) India ²Directorate of Extension Education, Birsa Agricultural University, Ranchi -834006 (Jharkhand) India

³Krishi Vigyan Kendra, Latehar, Birsa Agricultural University, Ranchi - 834006 (Jharkhand) India

ABSTRACT

The study was undertaken in Garhwa district of Jharkhand. Data were solicited from purposively selected 40 beneficiary dairy farmers under the Front Line Demonstration (FLD) programme of Krishi Vigyan Kendra (KVK) Garhwa district, Jharkhand, India. The important intervention extended by KVK Garhwa among dairy farmers was improved fodder cultivation technology. Findings of the study revealed that technological interventions extended by KVK have significantly empowered dairy farmers in technology as well as economically in general and particularly in increased milk production. FEAST computer programme was used to analyse feed resources of the study area and it has found that dairy farmers were depend upon feeding of paddy straw and trickle supplementation of concentrates. The results revealed that there were significantly ($P < 0.05$) increased in milk production after intervention of improved feeding practices of green fodder round the year. The study also revealed that feeding cost has reduced 38% after adoption of the technology. Training and demonstration programme on adoption of fodder production technology among dairy farmers could help towards increase in milk production and doubling farmer's income.

Study of Diversity of Family Encyrtidae (Hymenoptera: Chalcidoidea) in Forest and Agricultural and horticulture Habitat of Doon Valley, Uttarakhand, India.

Rashmi Nautiyal and Sudhir Singh

Harsh Vidiya Mandir (P.G) College, Raisi, Haridwar (Uttarakhand) Forest Entomology Division, Forest Research Institute, Dehradun (Uttarakhand)

ABSTRACT:

The Encyrtidae belongs to the Parasitic Hymenoptera group and is one of the largest family of superfamily Chalcidoidea. A large number of species of Encyrtidae have been utilized in the biological control of crop pests. The present study is based on collection of Encyrtidae (Chalcidoidea: Hymenoptera) made during a survey in Doon Valley from 2008 to 2011 in all the five seasons (Spring, Summer cum Pre-monsoon, Monsoon, Post-monsoon, Winter) for each year. The collections were made from different localities of forest and agriculture and horticulture habitat of the Valley using sweep net method. In all the tree habitats a total of 1322 encyrtids were collected with sweep net. Out of which 745 were collected from forest, 276 from agriculture and 301 were collected from horticultural areas. In forest habitat out of 745 encyrtid specimens, the highest number of 269 specimens were collected during post monsoon, 150 during summer, 129 during monsoon, 110 during spring and lowest of 87 specimens were collected during winter. In agriculture habitat out of 276 specimens, the highest number of 116 was collected during post monsoon, 56 specimens during spring, 39 specimens during winter, 36 during summer and lowest number of 29 during monsoon. In horticulture habitat out of 301 specimens collected, the highest numbers of 158 encyrtid specimens were collected during spring, followed by 56 during summer, 36 during post monsoon, 30 during winter and lowest of 21 specimens during monsoon. During collection 117 species of Encyrtidae belonging to 43 genera under 2 subfamilies were recorded. The subfamily Encyrtinae was represented by 93 species under 34 genera followed by subfamily Tetracneminae with 24 species under 9 genera.

Key words: Parasitic Hymenoptera, Encyrtidae, diversity, sweep net

Seed priming: a useful technique for abiotic stress management of crops plants

F. A. Khan^{*}, Sumati Narayan, Moinuddin[#], Mohammad Amir and Fasil Fayaz

Sher-e-Kashmir University of Agricultural Sciences and Technology of Kashmir, Shalimar-190025 (J&K), India

[#]Shri Guru Ram Rai University, Dehradun

ABSTRACT

Abiotic stresses severely affect the crop's growth and development at every stage of plant growth. Seed priming is a simple technique to enhance seed germination and growth especially under stressful environments. Seed priming is a controlled hydration technique where seeds are partly hydrated to allow metabolic events to occur without germination and are then re-dried to permit routine handling. Primed seeds usually have higher and synchronized germination owing to simply a reduction in the lag time of imbibition taking place, buildup of germination-enhancing metabolites, metabolic repair during imbibition and osmotic adjustment. The synchronization and promotion of germination under

3rd International Conference on “Global Initiative in Agricultural, Forestry and Applied Sciences for Food Security, Environmental Safety and Sustainable Development (GIAFAS-2021)”

adverse environment with seed priming may take place for several reasons, but changes in metabolite levels are important events during seed priming. It reduces the negative effects of abiotic stresses by reducing Malondialdehyde (MDA) and free radicals production and maintenance of antioxidant activities. Improved seed performance after priming has been explained by completion of DNA repair during priming and by a more favourable metabolic balance of primed seeds at the start of germination. The response of seeds to a priming treatment can vary between crop species and dependent on the duration of the treatment and the osmotic potential of the solution rather than a specific salt. To control hydration seeds are placed in solutions with high osmotic potential. This prevents seeds from entering Phase III of hydration by extending and holding seeds within the lag phase (Phase II). Currently many seed priming method have been used like hydro-priming, osmo-priming, halo-priming, thermo-priming, bio-priming and solid matrix priming. Primed seeds have great potential to grow under stressful conditions. It has strong resistance against abiotic and biotic stresses. Primed seeds have much growth potential and give more production as compared to non-primed seeds. It showed that more yield and uniformity as compare to non-primed seeds. Seed germination process occurs in the three phases. First phase in which seed uptake the water rapidly is named as imbibitional phase, second phase which just change in the water content and third or last phase is radical emergence. Primed seeds completed first two phases during priming process so immediately germinate after sowing. Present paper discuss various priming techniques used to manage the different types of abiotic stresses faced by the crop plants under field conditions.

Key words: Abiotic stress, seed priming, seed germination, antioxidants, vigour and yield

Effect of harvesting stages on seed physiological quality characteristics of French bean (*Phaseolus vulgaris* L.)” under temperate conditions of Kashmir

Ume Salma, F. A. Khan*, S. A. Bhat, Sumati Narayan, S. A. Mir, Showkat Ara, Moinuddin# and Fasil Fayaz

Sher-e-Kashmir University of Agricultural Sciences and Technology of Kashmir, Shalimar-190025 (J&K), India

#Shri Guru Ram Rai University, Dehradun

ABSTRACT

A field experiment was conducted during 2020-21 at Sher-e-Kashmir University of Agricultural Sciences and Technology of Kashmir to determine the most appropriate stage of harvesting Yellow French bean for optimal seed quality characteristics under temperate conditions of Kashmir. There were six treatments of harvesting dates with five replications. French bean pods were harvested at 25, 30, 35, 40, 45 and 50 days after anthesis (DAA). Harvested pods were tested in the laboratory for their pods, seed germination potential and nutritional quality attributes. Data recorded during the investigation was subjected to statistical analysis following the RCBD design. Results revealed that harvesting of Yellow French bean at 40 DAA resulted in highest fresh weight of pods, fresh weight of seeds, seed dry weight, fresh seed to pod ratio, pod length and pod circumference. Seeds harvested at 40 DAA also resulted in highest seed sugar and protein contents. Likewise, germination percent root and shoot growth and seedling vigour index I and seedling vigour index II were recorded as highest with harvesting of seeds at 40 DAA. Accelerated ageing (AA) of seeds further confirmed the integrity of seed quality harvested at 40 DAA. After AA ageing, seeds harvested at 40 DAA gave maximum germination percentage followed by the seeds harvested at 45 and 50 DAA while as seeds harvested at before 40 DAA deteriorated during AA and no seed was germinated. Therefore, harvesting of French bean cv. Yellow French bean should be done at 40 days after anthesis.

Key words: French bean, harvesting time, seed germination, accelerated ageing

Hydroponic fodder production: a boon for landless farmers

Moinuddin*, F. A. Khan, Sumati Narayan, Mohammad Amir and Fasil Fayaz

Shri Guru Ram Rai University, Dehradun

Sher-e-Kashmir University of Agricultural Sciences and Technology of Kashmir, Shalimar-190025 (J&K), India

ABSTRACT

Green fodder plays major role in feed of milch animals like cow, buffalo, etc. there by providing required nutrients for milk production and health of the animals. Non availability of irrigated lands for fodder production, higher labour cost, and small land holdings has left dairy farmer with many challenges for milk production. Hydroponics is considered as

3rd International Conference on “Global Initiative in Agricultural, Forestry and Applied Sciences for Food Security, Environmental Safety and Sustainable Development (GIAFAS-2021)”

the state of the art technology i.e. the growing plant without soil, in a liquid or soilless media. Hydroponic fodder production is a viable and farmer friendly alternative technology for the farmers whose soil is rocky and infertile or those farmers having no land for the purpose. Fodders including maize, barley, oats, sorghum, rye, alfalfa and triticale can be produced through hydroponic system. Compared to traditional fodder production which needs about two months to grow, hydroponic fodder system takes only 8-10 days and it can be produced regularly throughout the year. Also hydroponic fodder production requires only 3-4 liters of water for to grow one Kg of fodder while in traditional system approximately 70- 100 liter water is required. As there is no use of chemicals and fertilizers in this method of farming, we can get the organic outputs in this farming technology. In conventional farming, we may face the failure of crop or crop loss due to abiotic or biotic stresses but in this system there is least chance of such type of situations. The major advantage of this farming system is that we can grow the crops irrespective of their growing seasons. So that we can cultivate the crops round the year which leads to better returns throughout the year.

Key words: Fodder, hydroponics, livestock, soilless, yield

Prospects of hydroponic strawberry production in temperate region of India

Saima fayaz, F. A. Khan, Sumati Narayan, Moinuddin[#], Mohammad Amir and Fasil Fayaz

*Sher-e-Kashmir University of Agricultural Sciences and Technology of Kashmir, Shalimar-190025 (J&K), India
Shri Guru Ram Rai University, Dehradun, Uttarakhand, India*

ABSTRACT

Hydroponics is defined as ‘the practice of growing plants in liquid nutrient cultures rather than in soil’. In this system plant can be grown either in the inert medium such as gravel, cocopeat, etc. which are frequently irrigated with the nutrient solution or directly in nutrient solution. This system of crop production has increased significantly in recent years worldwide including India, as it allows more efficient use of water and fertilizers as well as better control of climate and pest factors. With increasing population, in order to meet demand for high quality and quantity of food production, there is need of development of technologies like Hydroponics. Strawberry fruit is widely appreciated for its characteristics aroma, bright red colour, juicy texture and sweetness. It is consumed in large quantities, either fresh or in prepared foods such as fruit juice, ice creams, etc. Fruit is good source of folic acid, vitamin C, potassium, fiber, bioactive compounds including antioxidants, etc. Hydroponic food production or growing food without soil, is increasing worldwide and seem to have a positive overtone as consumers are becoming more aware of the food safety and nutrition issue in relation to healthy lifestyles and disease prevention. Hydroponic strawberry proved to be a good option during today’s time for fresh supply of fruits and vegetables with enhanced nutrient and as well as antioxidant compounds. This system of food production can be practiced in places where traditional system of food production is not possible e.g., Metropolitan cities and problem soils. Hydroponic crops can also be grown under polyhouse condition where it not possible due severe cold or hot climatic conditions. It is a smart system of food production which can attract the youth as generally today’s generations don’t want to go for traditional agriculture. It can also be a good option to adopt as business and prove helpful in unemployment issue of the present time. Finally, growing of strawberry would be highly beneficial both in terms of fetching money as well as sustaining healthy life especially in temperate conditions.

Key words: Hydroponics, strawberry, quality, yield

Effects of Foliar Application of Melatonin on Head Yield and Quality of Broccoli cv. Palam Samridhi

Mansha Gul, F. A. Khan, S. A. Bhat, S. A. Mir, A. A. Malik, Amit Kumar, S. Narayan, Moinuddin and S. A. Lone

Sher-e-Kashmir University of Agricultural Sciences and Technology of Kashmir, Shalimar – 190025, Distt. Srinagar (J&K); Shri Guru Ram Rai University, Dehradun (Uttarakhand)

ABSTRACT

Broccoli is a cruciferous vegetable with green flower buds. It has a reputation as a superfood as it is low in calories but contains a wealth of nutrients and antioxidants that support many aspects of human health. Broccoli is a good source of fibre and protein, and contains iron, potassium, calcium, selenium and magnesium as well as the vitamins A, C, E, K

and a good array of B vitamins including folic acid. Thirty days old and uniform seedlings of broccoli cv. Palam Samridhi were transplanted in the field at a spacing of 45 × 45cm. Different concentrations of Mel, viz 0, 20, 40, 60 and 80ppm with three replications were sprayed at 15 days after transplanting (DAT). Head diameter, weight, chlorophyll and carotenoids, sugar, proteins and antioxidant were analyzed at harvest. Results showed that the maximum head diameter (10.7cm), weight (233.8g), chlorophyll (0.79mg/g.FW), carotenoid (0.028 mg/g.FW), phenol (178.1 mg/100g DW), total antioxidant (362.3 mg GAE 100g DW) and MSI (45.38 %) levels were recorded with Mel 60ppm. However, the highest levels of sugar (129.0µg/g) and protein (88.0 µg/g) were recorded with Mel 80ppm followed by Mel 60ppm.

Keywords: Antioxidants, broccoli sprout, melatonin, protein, sugar

Effects of accelerated aging and subsequent priming on seed quality and biochemical change of onion (*Allium cepa* L.)

Rifat Maqbool Bhat, Farooq Ahmad Khan, Imtiaz Murtaza, Gul Zaffar¹, Moinuddin* and Rifat Ramzan
*Sher-e-Kashmir University of Agricultural Sciences and Technology of Kashmir, Shalimar – 190025, Distt. – Srinagar (J&K) INDIA; *Shri Guru Ram Rai University, Dehradun (Uttarakhand), INDIA*

ABSTRACT

A study was performed at SKUAST-Kashmir to understand the mechanisms of seed deterioration under AA and its reversal through subsequent OP. The seeds were exposed to AA treatment for 0, 48, 72 and 96 hours at 45±2 °C and 100% R.H. Each lot of treated seeds was further divided into four sub-lots and osmo-primed with PEG 6000 for 0, 24, 48 and 72 hours at 25±2 °C. Fifty seeds from each sub-lot were placed in petri dishes and placed in an incubator at 25°C for recording various germination parameters. AA significantly reduced the GP and CVG from 85.56 and 43.78 (A0) to 12.66 and 9.00 (A3). There were significant reduction in shoot and root length (5.94 → 2.93cm; 4.83 → 2.99cm), seedling biomass (21.18 → 15.84md), SVIs (18.12 → 2.01; 921.5 → 75.0) in A3 compared to A0. However, these attributes were found to increase to maximum of 59.84%, 29.38, 5.38cm, 4.45cm, 19.69mg, 11.71 and 5.80 due to different OP treatments. In line, biochemical attributes like shoot chlorophyll, sugar, protein, MSI and anti-oxidant potential were also found to deprive due to AA effects and build up after OP treatments.

Key words: Accelerated ageing, onion, osmopriming, chlorophyll, antioxidant and seed germination

Watercore – a physiological disorder of apple related to imbalance carbohydrate metabolism in fruit tissues

Farooq Ahmad Khan, Sujat Ahmad Lone, Amit Kumar, Sajad Ahmad Bhat, Moinuddin[#], Umme Salma, Fasil Fayaz and Saima Fayaz

Sher-e-Kashmir University of Agricultural Sciences and technology of Kashmir, Shalimar, Distt. Srinagar (J&K); [#]Shri Guru Ram Rai University, Dehradun (Uttarakhand), India

ABSTRACT

Watercore is a physiological disorder of apple fruits resulted from the deviation of normal carbohydrate metabolism and accumulation of alcohol sugar, sorbitol in the intercellular spaces of the flesh tissues. The disorder is difficult to detect externally, however, in extremely severe conditions, the water-soaked areas can even extend out to the surface of the fruit and visible from outside the fruit. Transverse cutting of affected apple fruit showed a glassy appearance with translucent-water-soaked tissue in the fruit flesh around the vascular bundles and/or fruit core when the intercellular spaces are filled with a Sorbitol-rich fluid. Depending upon spatial distribution and pattern of water-soaked area on the flesh, watercore may be of block or radial type. The former a rectangular block of translucent tissue covering entire core area and extends into the flesh beyond the core area while as later affects carpellary bundles around the core-line and flesh that is adjacent to the affected vascular bundles. Block watercore generally occurs on immature apples during summer while ripening apple fruits mostly are affected by radial type of watercore. The disorder is associated with adverse pre- and/or post-harvest environment, especially temperature or to a nutritional deficiency during growth and development. Present understanding suggests that disorder is related to the unloading of sorbitol-rich liquid from the SE-CC of the vascular tissue to the apple fruit. During normal metabolism sorbitol must be converted to fructose by the apple fruit. Due to one or other reasons normal sorbitol metabolism is impaired, but that of sucrose is not. In affected tissues, the sorbitol is somehow inhibited from being metabolized by the cortex cells, leading to the accumulation of the

3rd International Conference on “Global Initiative in Agricultural, Forestry and Applied Sciences for Food Security, Environmental Safety and Sustainable Development (GIAFAS-2021)”

‘sorbitol-sap’ unloaded from the phloem cells and a reduction in reducing sugars (fructose and glucose) in the fruit cortex resulting in glassy appearance. However presence of watercore is difficult to recognize on the basis of external appearance. Various non-destructive techniques put forward for detection of watercore in apple including mass density, X-Ray CT, MRI, NIR, NMR and thermography have been discussed.

Key words: Apple, mass density, MRI, NMR, sorbitol, thermography, watercore

Physiological basis of sunburn development in fruits and vegetables

Farooq Ahmad Khan, Sumati Narayan, Sajad Ahmad Bhat, Imtiaz Murtaza, Moinuddin and Sujat Ahmad Lone

Sher-e-Kashmir University of Agricultural Sciences and technology of Kashmir, Shalimar, Distt. Srinagar (J&K); #Shri Guru Ram Rai University, Dehradun (Uttarakhand), India

ABSTRACT

Capsicum also known as bell pepper (*Capsicum annum*) requires day/night temperatures of 25-30°C and 18-20°C, respectively along with a relative humidity of 50-60%. However, fruit set is adversely affected if temperature exceeds 35°C or falls below 12°C. Unfortunately, the fruit is very susceptible to sunburn (sunscald) under conditions of elevated temperature coupled with high irradiance. Fruit exposed to the sun become extremely hot, in contrast to fruit protected by a dense canopy. The combination of hot weather and recent rain events increased the rate of fruit expansion, making fruit even more susceptible to sunburn. Additionally, sun damage makes the fruit vulnerable to plant pathogens; therefore, growers will likely see significant crop losses from sunscald in peppers over the next couple of harvests if they have plants with exposed fruit. Losses in excess of 30 percent could easily be observed in open field conditions. However under protected conditions especially after removal of some branches or defoliation, the situation worsen and more than 50 percent of fruits can be damaged by sunburn. Sunburn is a physiological disorder of fruits and fruiting vegetables caused by soaring temperature and high flux densities of solar radiation. Excess solar radiation may have a direct effect or its effect may be indirect through an increase in radiant heating, which increases the fruit surface temperature (FST). The occurrence of sunburn symptoms is a specific response of the fruit to these stressors. Sunburn can be viewed as the result of exceeding the possible beneficial effects of sun exposure. Sunburn affects a wide range of fruits, vegetables, ornamentals and shade trees. Symptoms on fruit and fruiting vegetables can range from white patches to dark brown burned spots depending on cultivars and the environmental conditions, often showing different patterns in the same cultivar. The problem of sunburn in vegetables like tomato, capsicum and brinjal has also been experienced for last few years in the Kashmir valley which causes a significant loss. Gradual increase in the global temperature may further aggravate the situation.

Key words: Capsicum, sunburn, physiological disorder, solar radiation, surface temperature

Effect of organic manures and biofertilizers on growth and seed yield of radish (*Raphanus sativus* L.) under temperate conditions of Kashmir.

Iqtab Mushtaq Wani, Sumati Narayan, Farooq Ahmad Khan, Khurshid Hussain, Sameena Maqbool, Iftisam Yaseen

Sher-e-Kashmir University of Agricultural Sciences and technology of Kashmir, Shalimar, Distt. Srinagar (J&K)

ABSTRACT

A field experiments was conducted at SKUAST- K, Shalimar during 2018-19 and 2019-2020 to evaluate the effect of organic manures and biofertilizers on plant growth and seed yield of radish. The experiment was laid out in RCBD with ten different treatment combinations of FYM, vermicompost, vermiwash and biofertilizers and replicated three times. Plots without any nutrient input was taken as control. Results revealed that minimum values for days taken to 50% flowering (119.57) and days taken to seed harvesting (195.53) were recorded with treatment T8 (100% vermicompost + bio fertilizers @ 5kg ha⁻¹). Moreover, treatment T8 recorded higher values for survival of stecklings (94.20%), plant height (148.63cm), number of branches plant⁻¹ (17.14), pod length (9.26cm), pod width (1.21cm), pod weight (0.42g), no. of pods plant⁻¹ (803.97), and seed yield (28.80g/plant).

Key words: Radish, bio-fertilizers, vermicompost, seed yield, steckling

Management of spot blotch of barley through different dates of sowing and chemical and organic amendments.

Mohammad Amir, J P Srivastava, Maneesh Kumar, Rishabh Kumar Singh, Moinuddin¹

Seed Technology Section, N.D. University of Agriculture and Technology, Kumarganj, Ayodhya (U.P.), ¹Department of Agriculture, SGRRU, University, Dehradun, Uttarakhand

ABSTRACT

Spot blotch caused by *Bipolaris sorokiniana* is one of the most serious disease of barley in tropical areas where barley and wheat are grown. Many factors including climate conditions and agricultural practices influence and spread of disease and thus affect the crop. It is mainly a seed borne pathogen. The seed yield may decrease even upto 30% as a result of leaf rust, ear and seed infection. The occurrence of *B. sorokiniana* on seed of barley depends on farming and cultivation system. Keeping in view, a field experiment was conducted at Regional Research Station Masodha, ANDUA&T, Kumarganj, Ayodhya, Uttar Pradesh during *Rabi* season of 2016-17 to evaluate the effect of different dates of sowing and chemical and organic amendments on spot blotch and consequently on seed quality of barley. The experiment was placed in split plot design with three replications comprising two different dates of sowing i.e. mid-November (D₁) and mid-December (D₂) in the main plot and chemical and organic amendments *viz.*, recommended dose of fertilizers (60N:30P:20K kg/hectare) -T₁, FYM @ 5 t/hect (at the time of land preparation)-T₂, T₁ + Mulch@ 6 t/hect (mulching after germination) – T₃, T₁ + FYM @ 5t/hect + Mulch @ 6t/ hect.- T₄, T₄ + 2 spray of zinc sulphate @ 0.5 % (flag leaf and post anthesis stages)- T₅, T₄ + 2 spray of KCl @0.5% (flag leaf and post anthesis stages) –T₆ and T₅ + 2 spray of KCl @ 0.5 % (flag leaf and post anthesis stages) – T₇ in the sub plot. Results revealed that minimum disease severity (46.9%) with maximum disease control (39.98%) and per cent seed infection (5.5%) were recorded in D₁T₇ (crop sown during mid-November with recommended dose of fertilizers +FYM @ 5 t/ha+ Mulch@ 6 t/ha+ 2 spray of zinc sulphate @ 0.5 % + 2 spray of KCl @ 0.5 % at flag leaf and post anthesis stage. The interpretation of data revealed that there was highly positive and significant correlation (r=0.95) between disease severity and per cent seed infection. The maximum 1000-seed weight (43.41g) and yield (38.67 q/ha) with maximum yield gain (57.25%) was also recorded in D₁T₇. The same treatment combination was also useful in maximizing the seed quality in terms of seed viability (98%), Germination (97%), seedling length (27.30cm) and vigour index-I (2648.153) when the freshly harvested seeds were tested in seed testing laboratory of ANDUA&T, Kumarganj, Ayodhya.

Key words: Barley, spot blotch, organic amendments, disease control

Mitigation of spot blotch of barley (*Hordeum vulgare* L.) through different nitrogen levels and PGPRs to maximize the seed quality

Mohammad Amir, Maneesh Kumar, R B Singh, Rajesh Kumar¹ and Hamsa P Prakash²

Seed Technology Section, N.D. University of Agriculture and Technology, Kumarganj, Ayodhya (U.P.)

ABSTRACT

Barley is one of the important cereal crops, widely grown in India and many other parts of the world. Barley is a valuable crop because it is grown for several purposes such as animal feed and fodder, malt and beer making and also as staple food for human consumption. In other countries barley is utilized for industrial uses. However in India, only 10 % is utilized as industrial raw material for manufacturing alcoholic drinks such as beer, whisky and various malted products for children and patients. Spot blotch caused by the fungus *Bipolaris sorokiniana* is one of the most important fungal diseases of barley. It is most serious in tropical areas where wheat and barley are grown. Yield losses caused by the pathogen have been estimated on average basis of 10% in barley. The fungus can limit the germination drastically, even to 25%, or the diseased seed gives rise to diseased and weak seedlings. Keeping in view, afield experiment was conducted at Research Station Masodha, ANDUA&T, Kumarganj, Ayodhya, Uttar Pradesh during *Rabi* season of 2016-

17 to evaluate the effect of different nitrogen levels and seed treatment with PGPRs on spot blotch and consequently on seed quality of barley. The experiment was placed in split plot design with three replications comprising three levels of nitrogen of recommended dose (N₁-50%, N₂-75% and N₃-100%) in the main plot and seed treatment with four different PGPRs along with control (B₁- Azatobater, B₂- PSB, B₃- Azatobacter+ PSB, B₄- Biomix and B₅- Control) in the sub plot. Results revealed that minimum disease severity (18.70%) and percent seed infection (6.5%) were recorded through 50% N of recommended dose and seed treated with Azatobacter plus PSB (N₁B₃). The interpretation of data revealed that there was highly positive and significant correlation ($r=0.984$) between disease severity and per cent seed infection. The maximum 1000-seed weight (44.07g) and yield 42.05 (q/ha) was recorded in N₁B₃ (50% N of recommended dose and seed treated with Azatobacter plus PSB) due to low disease severity and per cent seed infection. The same treatment combination was also useful in maximizing the seed quality in terms of seed viability (96%), Germination (92%), seedling length (28.43cm) and vigour index-I (2616.33) when the freshlyharvested seeds were tested in seed testing laboratory of NDUA&T, Kumarganj, Ayodhya.

Key words: Barley, *Bipolaris sorokiniana*, spot blotch, PGPRs, nitrogen, disease control

New record of twelve species of Encyrtidae (Hymenoptera: Chalcidoidea) from different states of India

T. Krishna Chaitanya¹ and S. Manickavasagam¹

¹*Parasitoid Taxonomy and Biocontrol Laboratory, Department of Entomology, Faculty of Agriculture, Annamalai University, Chidambaram 608002, Tamil Nadu, India.*

ABSTRACT

Surveys were conducted in different parts of Andhra Pradesh, Assam, Bihar, Karnataka, Kerala, Maharashtra, Manipur, Meghalaya, Nagaland, Puducherry, Tamil Nadu and Telangana. New distributional records of thirteen species of encyrtids from different states of India were recorded. Twelve encyrtid species viz., *Agarwalencyrtus citri* (Agarwal), *Alamella flava* Agarwal, *Anomalicornia tenuicornis* Mercet, *Cryptanusia ajmerensis* (Fatma & Shafee), *Yasumatsuiola orientalis* (Trjapitzin), *Ethoris dahmsi* Noyes & Hayat, *Hemileucoceras longicornis* Hayat, *Hesperencyrtus gordhi* (Fatma & Shafee), *Monstranusia antennata* (Narayanan), *Paratetracnemoidea malenotti*, (Mercet), *Pentelicus depunctatus* Manickavasagam & Chaitanya and *Pentelicus punctatus* Manickavasagam & Chaitanya are newly recorded from different states of India.

Integrated Disease Management of Charcoal Rot of Sesame (*Sesamum indicum* L.) Incited by *Macrophomina phaseolina* (Tassi.) Goid.

Kiran Choudhary and A. K. Meena

Department of Plant Pathology, College of Agriculture, Swami Keshwanand Rajasthan Agricultural University, Bikaner

ABSTRACT

Charcoal rot is one of the important disease of sesame (*Sesamum indicum* L.) and caused by *Macrophomina phaseolina* (Tassi.) Goid. The diseased samples were collected from vicinity of the Bikaner district and used for the isolation and prove the pathogenicity. The pathogenic nature of *M. phaseolina* on the basis of per cent disease incidence was tested on susceptible variety of sesame. Isolated fungal and bacterial bio-agents i.e. *Trichoderma harzianum*, *Trichoderma viride* and *Bacillus subtilis* and *Pseudomonas fluorescens* were tested against *M. phaseolina*. The antagonistic reactions of bio-agents were developed by inhibition of mycelial growth and a clear zone between colonies of antagonist and the pathogen. The mode of action of bio-agents against *M. phaseolina* was studied under *in vitro* and *in vivo* conditions. Relative humidity maximum (X₃) found significantly positively correlated while relative humidity minimum (X₄) was not significantly positively correlated with the charcoal rot intensity. Charcoal rot intensity was found negatively correlated but significantly with minimum temperature (X₂) and maximum temperature (X₁) was not significantly but negatively correlated in all varieties. Minimum mycelial growth was recorded in bio-agents *T. harzianum* (19.00mm) and fungicides tebuconazol 2DS (13.30mm) *in vitro* conditions. Tebuconazole 2DS seed treatment plus tebuconazole

3rd International Conference on “Global Initiative in Agricultural, Forestry and Applied Sciences for Food Security, Environmental Safety and Sustainable Development (GIAFAS-2021)”

25.9 EC soil drenching was most effective to minimize the charcoal rot incidence (9.52%) and maximum per cent disease control (84.13%). Similarly, the grain yield was highest obtained (480.60 kg ha⁻¹) in tebuconazol 2DS plus tebuconazol 25.9 EC used as seed treatment plus soil drenching.

Prominence of Carbon nanotubes - New Trend of Agriculture

M. Lakshmi Durga

Dept. of Farm Power and Equipment, ICAR- CIAE, Bhopal, M.P.

ABSTRACT

Carbon nanotube became wondering material in different science fields with inbuilt properties like high aspect ratio (1,00,000), high mechanical strength, ultralight weight, high thermal and electrical properties. The present research generation adopting these CNTs in different science sectors. At present scenario of world population, the requirement of food production increasing with sharp peak. There is requisite to find measures to enhance the yield and quick growth of the various food crops that are being cultivated in the country. However, increased and persistent use of chemical fertilizers not only increases the toxicity of the crop but they also render the soil unfertile and increase the salinity of the soil, hence leaving it unsuitable for further agricultural purposes. The need of the hour is a new “Green Revolution” for a sustainable increase in the food production. The theme implies to the Carbon nanotubes (CNTs), these are hollow cylindrical structure rolled up by a either single layer or multi-layered graphene sheets. CNTs are categorized into single walled and multi walled CNTs. Therefore, the role of carbon nanotubes in this context is an exciting prospect that needs to be further explored given its potential to improve the plant growth parameters. Apart from that CNTs comprises various applications in agriculture to increase the germination capacity, plant growth, water and nutrient intake capacity and enhancement of biomass production. Simultaneously, several studies are going to know the effect of CNTs on further stages of the crop. Similarly, the usage of CNTs in agriculture given positive results along with negative remarks at high concentrations. At high concentration/ dosage diminishes the growth of plant.

Keywords: Carbon nanotubes, agriculture, plant growth and crop yield.

Influence of salicylic acid application on growth characteristics and herbage yield of vegetatively propagated *Bacopa monnieri* (L.)

Shamiya Jahan* and Sonia Tamta**

**Department of Plant Physiology, College of Basic Sciences and Humanities, G. B. Pant University of Agriculture and Technology, Pantnagar, (263145) Uttarakhand, India*

ABSTRACT

Bacopa monnieri is important medicinal herb and commonly know as Brahmi. Bacosides (dammarane-type triterpenoid saponins) is main active chemical constituent in brahmi, which influences the memory enhancing effect due to highly commercial value in herbal industries. However, the lack of high bacoside cultivars has limited pharmaceutical utilization and production. Salicylic acid (SA), naturally occurring phenolic compound in many plants, is considered to be a potent plant hormone because of its diverse regulatory roles in plant metabolism and also regulated the plant growth and development. Optimisation of suitable concentrations of plant growth regulators has been accomplished for the highest biomass production. To find out the effect of foliar application of SA with different concentration on growth parameters and overall herbage yield, a pot experiment was conducted in the year 2021 at GBPUA&T, Pantnagar. Growth parameters were analysed after 30 days of each foliar sprays i.e. first foliar spray and second foliar spray in 30 days of interval whereas the overall herbage yield was observed after 90 days from transplanting time. The obtained results indicated that growth parameters such as shoot length and shoot numbers/pot, significantly increased of 25.88% and 20.74% with conc. of SA (75 mg L⁻¹) after 30 days of first foliar spray when compared with control. While same growth parameters, significantly increased of 26.71% and 33.33% with conc. of SA (75 mg L⁻¹) after 30 days of second foliar spray when compared with control. Whereas no. of leaves per shoot significantly increased of 51.86% and 50.35% with conc. of SA (50 mg L⁻¹) after 30 days of first and second foliar spray when compared with control. There was a significant increase in fresh herbage yield per pot (18.84%) and dry herbage yield per pot (31.23%) of the plant after 90

3rd International Conference on “Global Initiative in Agricultural, Forestry and Applied Sciences for Food Security, Environmental Safety and Sustainable Development (GIAFAS-2021)”

days when SA (75 mg L⁻¹) was applied foliarly twice after 30 days of interval. Hence, it is concluded that the optimum level of SA significantly affected growth characteristics of Bacopa followed by improved yield of a crop.

Keywords: Herbs, salicylic acid, foliar spray, growth characteristics, Herbage yield.

Effect of organic manures and biofertilizers on seed yield and soil nutrient status after harvest of spinach beet (*Beta vulgaris* var. *bengalensis*)

Asma Jabeen¹, Sumati Narayan², Geetika Malik³, Sanjay Chadha⁴

SKUAST- K Shalimar

ABSTRACT

A field experiment was conducted at Vegetable Experimental Farm, SKUAST- K Shalimar during Rabi season to evaluate the effect of organic manures and biofertilizers on seed yield and soil nutrient status after harvest of spinach beet. The experiment was laid out in RCBD with nine treatment combinations replicated three times. The treatments comprised of organic manures viz., farm yard manure, sheep manure, vermicompost, mustard cake and two types of bio-fertilizers namely Azospirillum and PSB, including RFD (recommended fertilizer dose) as control. Results revealed that sole application of vermicompost @ 3.0 t ha⁻¹ increased the seed yield per plot (0.437 kg), seed yield per hectare (11.02 q), 100 seed weight (1.93), available phosphorous ha⁻¹ (22.96 kg), available potassium ha⁻¹ (214.60 kg), organic carbon (1.33 %) and electrical conductivity (0.120 dS m⁻¹). Results further indicated that application of biofertilizers @ 5.0 kg ha⁻¹ in combination with vermicompost @ 3.0 t ha⁻¹ significantly increased the seed yield per plot (0.633 kg), seed yield per hectare (15.88 q), 100 seed weight (2.33), available nitrogen ha⁻¹ (287.16 kg), available phosphorous ha⁻¹ (28.91 kg), available potassium ha⁻¹ (229.03 kg), organic carbon (1.35 %) and electrical conductivity (0.122 dS m⁻¹). Treatments RFD (control) and mustard cake recorded the lowest values for seed yield and soil parameters.

Keywords: Spinach beet, vermicompost, biofertilizers, seed yield, soil

Spirulina-derived bioactive compounds: emerging and potential source for food and medicine

Manpreet Kaur^{a*}, Surekha Bhatia^b, Urmila Gupta^c, Yamini Tak^d, and Manoj Bali^e

^aDepartment of Biochemistry, Punjab Agricultural University, Ludhiana, India, 141004

^bDepartment of Processing and Food Engineering, Punjab Agricultural University, Ludhiana, India, 141004,

^cDepartment of Renewable Energy Engineering, Punjab Agricultural University, Ludhiana, India, 141004,

^dAgricultural Research Station, Agricultural University, Ummedganj, Kota, India, 324001,

^eResearch & Development, Chemical Resources (CHERESO), Panchkula, Haryana, India, 134109,

ABSTRACT

Spirulina (*Arthrospira*) is filamentous microalgae originated 3.5 billion years ago and amongst the oldest organisms on earth¹. It belongs to Oscillatoriaceae family and can extensively grow in variety of habitats especially alkaline lakes, tropical, subtropical areas, and extreme environments. In past few decades, microalgae-biomass has gained an interest towards sustainable production of bioactive compounds because of its incredible potential for being a good host for variety of bioactive metabolites. *Spirulina* is rich in proteins (64-73% dry weight) rich in essential fatty acids, carbohydrates (12-17 %), lipids (5-7 %) consisting of 48.2% saturated, 13.6% monounsaturated, 14.5% linoleic acid, and 21.1% linolenic acid mainly γ -Linolenic acid, vitamins (up to 1320 mg/kg) including vitamin B₁, B₂, B₃, B₆, B₁₂, C and D, pigments including carotenoids (4000 mg/kg) and alkaloids, terpenoids, flavonoids, phenolic compounds and other nitrogen containing compounds^{2, 3}. Many of these compounds have antimicrobial, antioxidant, anti-inflammatory, anti-cancerous and anti-diabetic activities^{4, 5, 6}. In this view, phytochemicals derived from microalgae are of special attention in the advancement of production of new products for nutraceutical, pharmaceutical, food and feed industries. The benefits of using microalgae in comparison to plants is the in higher yield of biomass, proficient capturing of sunlight and carbon for metabolites production, limited use of arable land, and faster multiplication.

Furthermore, these metabolites represent an economical, cost-effective, efficient and sustainable commercial approach alternative to plant-based synthesis.

A Versatile Flavonoid Quercetin and its Health Benefits

Yamini Tak^a, Rajendra Kumar^b, Manpreet Kaur^b, Praveen Kumar Chachaiya^d

^aBiochemistry, Agriculture University, Kota, Rajasthan-324001, India

^bEntomology, MBDDS Girls College, Siswali, Baran, Rajasthan-325206, India

^cBiochemistry, Punjab Agricultural University, Ludhiana, Punjab- 141004, India

^dCollege of Agriculture, Agriculture University, Kota, Rajasthan-324001, India

Corresponding author email: yaminitak1992@gmail.com

ABSTRACT

Quercetin is a polyphenolic flavonoid found in a variety of plants and foods such as red wine, onions, green tea, apples, berries, ginkgo biloba, and buck wheat. Although it is best known for its antioxidative properties, numerous studies have shown that it also has anti-inflammatory, antiplatelet, antiapoptotic, nephroprotective, gastroprotective and anti-aging properties, as well as a anticarcinogenic. The ability of quercetin to scavenge highly reactive species like peroxynitrite and the hydroxyl radical is thought to be involved in these potential health benefits. Although, quercetin is not soluble in water and poorly absorbed nutrients, it is immediately metabolized by enzymes in the epithelial cells after absorption in the small intestine and further metabolized by the liver. Quercetin acts as an allergen preventative and suppresses the production of enzymes responsible for the production of potent leukotrienes. *In vitro* and *in vivo*, quercetin inhibits cytokine and inducible NOS expression by inhibiting the NF- κ B pathway. Several recent studies suggest that quercetin's chemo preventive properties may be related to its ability to regulate the expression of miRNAs involved in the inflammatory response. Co-administration of vitamin C and quercetin has a synergistic antiviral effect due to their overlapping antiviral and immunomodulatory properties, as well as ascorbate's ability to recycle quercetin, increasing its efficacy. Quercetin dosages ranging from 3 mg to 1000 mg per day have no adverse effects, but high doses (approximately 3591 mg) have been linked to renal toxicity.

Mapping of QTLs associated with drought tolerance component traits in wheat under multilocation irrigated and rainfed environments

Shashikumara, P^{1*}, Harikrishna², Neelu Jain², SV Sai Prasad², P. C Mishra³, P. K Singh², G. P Singh⁴ and K. V Prabhu⁵

¹ICAR-Indian Grassland and Fodder Research Institute, Jhansi 284003, India

² ICAR-Indian Agricultural Research Institute, New Delhi 110 012, India

³ Jawaharlal Nehru Krishi Vishwa Vidyalaya, Jabalpur, Madhya Pradesh 482 004, India

⁴ICAR-Indian Wheat and Barley Research Institute, Karnal, 132001, India.

⁵PPV & FR Authority NAAS Complex, New Delhi 110012, India

ABSTRACT

Identification of QTLs associated with major physiological and yield component traits under drought stress conditions in wheat helps in marker-assisted selection for developing drought tolerant cultivars. Backcross inbred lines (BILs) consisting of 183 lines in the background of HD2733, were developed by crossing HD2733, which is a drought susceptible variety with a drought tolerant variety C306. BILs were genotyped using 35K Axiom genotyping array and 86 SSR markers. The genetic linkage map was constructed using co dominant 706 SNPs from 35k wheat Breeding array and 86 SSRs using ICIM v4.1 software. The BILs were phenotyped for 14 physiological and grain yield component traits under multi-location field trials done at three locations at IARI New Delhi, IARI regional station Indore and

Powarkheda under irrigated and rainfed conditions. A linkage map was constructed using 705 SNPs and 86 SSR polymorphic markers. The marker density of the individual chromosomes ranged from 2.78 cM/marker for 1A to 21.7 cM/marker for 5D with an average marker density of 5.93 cM/marker. A total of 43 genomic regions and QTL×QTL epistatic interactions were identified for traits including NDVI, chlorophyll content, canopy temperature (CT), relative water content (RWC), coleoptile length (CL), flag leaf area (FLA), days to heading (DH), plant height (PH), grain weight per spike (GWPS), thousand grain weight (TGW) and grain yield (GY). Chromosomes 2A, 5D, 5A and 4B harbors greater number of QTLs for these traits. Seven Stable QTLs were identified across environment for DH (QDh.iari_6D), GWPS (QGWPS.iari_5B), PH (QPh.iari_4B-2, QPh.iari_4B-3) and NDVI (QNdvi1.iari_5D, QNdvi3.iari_5A). Nine major QTLs were detected for various traits; NDVI (QNdvi2.iari_2A), FLA (QFla.iari_2D), RWC (QRwc.iari_7A), BIOMASS (QBiomass.iari_7B), PH (QPh.iari_4B-1 and QPh.iari_4B-2), TGW (QTgw.iari_2A), and CL (QCl.iari_4B and Q.Cl.iari_5D) explaining 10.32–28.35% of the phenotypic variance. The co-segregation of QTLs of physiological traits with yield component traits indicate the pleiotropic effects and their usefulness in the breeding programme. The identified QTLs can be used in marker assisted selection programme for developing drought tolerant cultivars.

Key words: Wheat, drought tolerance, backcross inbred lines, QTL mapping, SNP, SSR

Flower waste management – a wonderful opportunity for uplifting economical status of rural women

Gandham Aditya^{*}, Rayavarapu Tejaswi¹ and Zehra Salma²

^{}COH (Dr. Y.S.R.H.U), Anantharajupeta, Andhra Pradesh – 516105,*

¹Dept. of FLA, IARI- Pusa campus, New Delhi – 110012 &

³FRS, Rajendranagar, Hyderabad, Telangana – 500030.

ABSTRACT

Flowers are inseparable from the social fabric of human life. Flowers being an adorable creation of god, befits all occasions like marriage ceremonies, festivals and other sacred ceremonies. However, management of flower waste became a major concern threatening the deterioration of environment in an alarming proportion. Dumping of flower waste in water bodies like rivers, oceans cause water pollution and also affects the survival of organisms present in the ecosystem. Disposal of flowers in open places cause soil and environmental pollution. There are many strategies to convert this flower waste into value added products for agriculture (compost), for industrial use (bio gas generation, dye extraction, essential oil extraction, making incense sticks and food products) and for other purposes (dry flower technology and making handmade papers). There are some technologies developed to convert flower waste into value added products by CSIR- CIMAP (making incense sticks), CSIR-NBRI (dry flower technology and herbal gual preparation) and IIT, Kanpur etc. Proper utilization of floral waste can reduce the environmental pollution in an eco-friendly way and also provides employment opportunities for local women.

Key words: flower waste, environment, rural women, value edition.

Effect of irrigation salinity on morphological characteristics of rice genotypes.

Megha Budakoti and Deepti Shankhdhar

Department of Plant Physiology, College of Basic Sciences & Humanities, G. B. Pant University of Agriculture & Technology, Pantnagar, Uttarakhand, India

ABSTRACT

The effect of salinity on morphological characters of salt sensitive Pant Basmati1, Pant Dhan24 and salt tolerant CSR30 genotypes were analysed in two factors Completely Randomized Design with three replications. Three genotypes under control and 100mM NaCl condition randomly assigned in a plastic pot. The different morphological characters such as plant height, total number of tillers, leaf number and Total Dry Matter (TDM) content were analysed under control and 100mM NaCl condition. Results showed that plant height, total tillers, root, shoot and total dry matter were significantly decreased by the application of 100mM NaCl. Highest reduction in all the parameters (Plant height, tiller number, leaf number and total dry matter) was found in Pant Basmati1 followed by Pant Dhan 24 at 100mM NaCl. Whereas, reduction rate was slower in CSR23 as compare to other genotypes.

Key words: Salinity, growth, yield, cultivars, rice.

Evolution and global status of Cross laminated timber as Concrete of 21st century

Priyank Maithani, Shakti Singh Chauhan, Rakesh Kumar

IWST Bengaluru

ABSTRACT

Beginning of the 20th century witnessed industrial revolution, construction sector was mainly based on development of reinforced concrete. Reinforced concrete was a game changer and it completely revolutionised the world of construction, due to its adaptability to almost every sector of construction. Concrete brought innovations and enabled construction of building using different shapes and geometry which would not been possible with conventional materials and technologies. But if we talk about 21st century, every single development route is attached with a new thread known as “climate change” and due to this other sustainable materials are also entering in to the construction market. One of these technologies is Cross Laminated Timber also known as CLT or Xlam. Cross laminated Timber also known as crosslam or CLT, was developed in Europe in the early 90’s. Lightweight, aesthetically superior and eco-friendly, this material has become one of the most focused global constructive methods. CLT are panels formed by layers of wood glued to each other orthogonally, always in odd numbers, symmetrical with respect to the core or central layer. The current study highlights the concept of CLT, its history and evolution in the market and overall global status. India is also making efforts in this regard. CLT offers several advantages over conventional construction material like masonry, concrete, cement etc and technocrats even calling it “Concrete of 21st century”. It promotes sustainability as judicious utilization of resources is also a conservation.

Keywords: CLT, crosslam, Xlam, reinforced concrete, orthogonally, sustainability

Therapeutic Management of Post-parturient udder edema in goats

K.P. Singh^{*1}, R.V. Singh², R. A. Siddique³, Praneeta Singh⁴ and S. K. Singh⁵

1: Government Veterinary Hospital, Deoranian, Bareilly, Uttar Pradesh

2: Department of Pharmacology, Bhavdiya Institute of Pharmaceutical Sciences and Research, Ayodhya, Uttar Pradesh

3: Department of Physiology and Biochemistry, C.V.Sc. & A.H., SBPUAT, Meerut,

4: Department of Livestock Products Technology, C.V.A.Sc., GBPUAT, Pantnagar, U.S.Nagar, Uttrakhand

5: Government Veterinary Hospital, Ailiya, Sitapur, Uttar Pradesh

ABSTRACT

Udder edema is a periparturient disease characterized by excessive accumulation of fluid in the intracellular space of the mammary gland. It is swelling of the udder, teats and sometimes of the lower abdomen. A total of 8 nondescript goats of first to second parity were presented with a history of kidding 2-3 days back and edema of udder and teats after 12-24 hours after kidding. On palpation of the udder and teats, the swelling was found to be soft and cold. A watery to serous fluid was aspirated in all the goats after inserting the 18 gauge of an aseptic needle directly into the udder and pocket of fluid present in teats. The “fingerprint” test was applied to diagnose the presence of edema. All the goats were treated with furosemide, ceftriaxone, meloxicam, chlorpheniramine maleate Vitamin A, D3, E with massage and hot fomentation of the udder. The result indicated that the recovery rate from post-parturient udder edema in goats was 87.5 % after 6 days of therapy.

Keywords: Edema; goats; teats; udder

Market Arrivals and price behaviour of Wheat in APMC, Akola (M.S.)

Sulbha M.Sarap¹ Dr.Devyanee K.Nemade², Dr.Sunil N.Ingle³

1, Shri Shivaji Agriculture College, Amravati

2. Dr.Panjabrao Deshmukh Krishi Vidyapeeth, Akola.

3. Shri Shivaji Agriculture College, Amravati

ABSTRACT

This study was carried out to know the arrival and price behaviour of Wheat in APMC Market, Akola for the period 2006-07 up to 2017-18. This study was based on the secondary data on arrivals and prices of Wheat crop. The data on market arrivals and wholesale prices of Wheat crop was collected from record of Agricultural Produce Market

3rd International Conference on “Global Initiative in Agricultural, Forestry and Applied Sciences for Food Security, Environmental Safety and Sustainable Development (GIAFAS-2021)”

Committee (APMC) Akola. The data pertained to the period for twelve years. It indicated that the annual compound growth rates of arrivals in Wheat was highly significant at 1 per cent level, indicating thereby, the prices of wheat was increasing by 7.46 per cent per annum. In Wheat, peak arrivals were observed in the month of April **408.06** per cent in year 2017-18 the arrival index was as low as 3.88 per cent in the month of February in year 2013-14 and the highest price index noticed in the month June in year 2017-18 of 126.26 per cent, the price index was as low as 84..53 (June) in year 2012-13. The monthly seasonal indices of arrivals were found higher immediately after harvest and the price index of Wheat was found lower during immediately after harvest.

Key words: Arrival, Prices, APMC, and Wheat.

***In vitro* screening of botanicals and bio-agents to manage black scurf of potato disease, caused by *Rhizoctonia solani*.**

Tania Nuri

Department of Plant Pathology, Palli-Siksha Bhavana, Visva-Bharati, Sriniketan, West Bengal-731236, India

ABSTRACT

Science ages, in many potato growing regions in the world, black scurf of potato caused by *Rhizoctonia solani* is a seed and soil born disease making severe problem, resulting huge economic losses. A trial was conducted by using ecofriendly products, botanicals (Neem, ginger, onion, garlic and turmeric) and bio-agents (*Trichoderma asperellum*, *T. viride*, *T. koningii*, *T. longibrachiatum* and *T. harzianum*) to identify the more effective approaches for managing the disease in laboratory condition as well as taking Kufri Jyoti variety in pot condition during two consecutive years. In laboratory, Potato Dextrose Agar were amended with botanicals for growing the fungus and potato seed tubers were treated with different concentration of aqueous extract of botanicals and spore suspensions of bio-agents for pot condition. 100% mycelial growth of *Rhizoctonia solani* were successfully inhibited by 15, 20 and 25 ml of garlic extract. All concentrations of ginger extract showed less effective result. From 25% garlic extract recorded 79.22 % of eye germination of seed tuber and from 5 % of ginger extract recorded the least 11.84%. Minimum disease incidence (5.68%) and disease severity (0.16%) were found in 25% of garlic extract and maximum (disease incidence 78.17% and disease severity 12.95%) were register in 5% of ginger extract. *T. harzianum* show the best result at eye germination %, reduction of disease severity and incidence over control during 2 years (89.74%, 83.30% and 57.60% respectively). Oppositely, compare to others *T. longibrachiatum* was not enough efficacious for controlling *Rhizoctonia* disease. These ecologically sound treatments can shift effective and profitable management of this potato disease.

Keywords: Black scurf, bio-agent, bio pesticide, phyto-extract, *Rhizoctonia solani*

Assesment of Potential therapeutic properties of Green tea Aqueous extract against Imidacloprid toxicity in Chick

Tejinder Kaur Chhabra

Department of Life Sciences, IIS (deemed to be University), Gurukul Marg, SFS, Mansarovar, Jaipur -302020

ABSTRACT

Previous studies have suggested that insecticides are responsible for causing a number of health problems. The study under consideration aims to show the possible morphological and skeletal malformations induced due to *in ovo* administration of Imidacloprid (IMI) with or without Green tea (GT) during the organogenesis of developing chick embryo at doses 0.001mg/egg, 300mg/egg for IMI and GT comparing with control. The investigation revealed evident reduction in the length and weight of the embryos as well as body malformations. Most of the congenital malformations were seen in the IMI injected groups such as short beak, anencephaly, failure of retraction of the yolk sac, limb defects, ectopic viscerae, sparse body hairs, curved scapula and retardation in the degree of ossification were the most evident in the endoskeleton malformations. Co-administration of GT with IMI ameliorate the reversed effects of IMI on the shape, length, body weight and the skeleton of embryos.

3rd International Conference on “Global Initiative in Agricultural, Forestry and Applied Sciences for Food Security, Environmental Safety and Sustainable Development (GIAFAS-2021)”

Keywords: Chick embryos, Teratogenicity, Ameliorate, Imidacloprid, Green tea, Malformation, Morphological, Skeletal

Growth and Instability in Area, Production and Productivity of Coffee in Kodagu district and Karnataka state

Thanuja P^{1*}, G.L. Meena², Babita Kumari³

¹ Department of Agricultural Economics and Management, MPUAT, Udaipur, 313001, India

² in the Department of Agricultural Economics and Management, MPUAT, Udaipur, 313001, India

³. SKRAU-Bikaner

ABSTRACT

Coffee is known as sage’s milk and brown gold conquered third position among most transacted good in international market. India is the one of the most leading producer of coffee. Karnataka stands first in Area and production of coffee with having Kodagu District as the “coffee cup of India”. The present study completely depended on secondary data collected from 2000-01 to 2019-20 and aimed to estimate compound growth rate in area and production of coffee in kodagu district as well as Karnataka state. Compound growth rate and Cuddy-della valle instability index was used for the study. The study revealed that the growth rate over years for both area and production under Kodagu district and Karnataka state was very less showing very less increase in both parameters. It may be due to the long life span of coffee plant. Instability in production and area of the state as a whole was highest compared to instability in area and production of Kodagu district.

Information and communication technology: concept and constraints faced by students

Gargi Paliwal¹; Dr.D.K. Singh²; Samarjeet Singh³

¹Department of Agricultural Extension & Communication; Govind Ballabh Pant University of Agriculture & Technology, Pantnagar-263145, Uttarakhand., India

^{2,3}. Department of Agricultural Extension & Communication; Sardar Vallabhai Patel University of Agriculture & Technology, Meerut-250110, U.P., India

ABSTRACT

Information and Communication Technology is defined as technologies that are used to interlink information technology devices such as personal computer, slide projectors, television, digital camera, with communication technologies such as telephone and the telecommunication networks which enable the users to store, transmit, access and manipulate information. Information and Communication Technology can facilitate fast, cheap, equitable and resource-efficient access to information, accumulate knowledge, learning opportunities for students and farmers. ICT had an enormous impact on each sector of the life across the past two-three decades. The present study was conducted in Meerut District of Uttar Pradesh. Study Sample comprised of 90 students selected randomly from 3 colleges of Sardar Vallabhbhai Patel University of Agriculture and Technology, Meerut. The paper attempted to achieve two objectives, to discuss the concepts of Information and Communication Technology; and to analyze the constraints to the use of Information and Communication Technology. Data was collected with the help of pre-structured Interview schedule. The findings of the study revealed that the major constraints faced by respondents regarding use of ICT tools was continue work on Internet causes eye pain, Back pain and headache, problem of poor network on mobile phone and unwanted service activate on mobile phone.

Keywords: ICT, Concept, Constraints.

Diversity analysis and clustering of chickpea genotypes using SSR markers

Nimita Kandwal and R. K. Panwar,

Department of Genetics & Plant Breeding, College of Agriculture, G.B.P.U.A. & T Pantnagar

ABSTRACT

Genetic diversity analysis is an important tool in crop improvement and analysing genetic variation with molecular technologies gives information at the DNA level. Genotypes with high genetic diversity are a valuable source of variation used in breeding programs. The aim of this study was to assess the level of genetic diversity among 24

3rd International Conference on “Global Initiative in Agricultural, Forestry and Applied Sciences for Food Security, Environmental Safety and Sustainable Development (GIAFAS-2021)”

genotypes belonging to the chickpea, using SSR primers. The UPGMA (un-weighted pair group method with arithmetic mean) cluster tree analysis was developed with the help of Jaccard's similarity coefficient of SSR marker data of two polymorphic primers generated on twenty four genotypes by using the programme NTSYS 2.11. UPGMA arranged the population of 24 genotypes into mainly five cluster. DNA analysis classified all genotypes into 5 cluster which is more precise. Therefore, classification on the basis of SSR markers could be more relied upon for developing breeding strategies in chickpea.

Keywords: Genetic diversity, SSR marker, chickpea genotypes.

Development of union fabrics from blended yarns of delignified *dhaincha* fibres with cotton and bamboo fibres

POOJA BHATT¹ AND ANITA RANI²

Department of Clothing and Textiles, College of Home Science, G. B. Pant University of Agriculture and Technology Pantnagar, U. S. Nagar, Uttarakhand

ABSTRACT

The natural fibres have dominated textile industry for a long period of time. After the advent of synthetic fibres, use of natural fibres declined. The use of natural fibres have gained impetus due to alarming environmental concerns caused by increased production and use of synthetic fibres, chemical and auxiliaries. The bast fibres are such underutilized natural fibres which have opportunity to enter high quality textile market through application of appropriate chemical techniques to enhance physical and chemical properties of fibres. The present study was focused on preparation of union fabrics from blended yarns of delignified *dhaincha* (*Sesbania aculeata*) fibres with cotton and bamboo. The union fabrics were prepared from yarns developed from blending delignified *dhaincha* fibres with cotton and bamboo fibres. The union fabrics were developed from blended yarns of *dhaincha* with cotton and bamboo fibres. Four union fabrics were woven from *dhaincha* and cotton yarns in ratio (30:70 and 40:60) and *dhaincha* and bamboo yarns in ratio (30:70 and 40:60) on handloom using plain weave. Two pure fabrics used as control were developed from 100% cotton and bamboo yarns. The physical and functional properties of the developed fabrics revealed that as the percent of *dhaincha* increased in blended yarns the thickness and weight of union fabrics increased and the functional properties like wettability and air permeability enhanced. Thus, preparation of union fabrics from blended yarns developed from delignified *dhaincha* fibres with cotton and bamboo paved opportunity for *dhaincha* fibres to be used extensively in textile sector. Also, it would increase market value of *dhaincha* fibres and widen scope of use of plant for different value added products.

Keywords: *Dhaincha* fabrics, *Sesbania aculeata*, union fabrics, delignification, blending.

Integrated management of *Fusarium* Head blight in North Eastern Gangetic plains

Gnanasing J. Maharaja, S. Hembram, M. K. Debnath, P. M. Bhattacharya, A. Roy, A. K. Chowdhury.

Uttar Banga Krishi Viswavidyalaya, Pundibari, Cooch Behar.

ABSTARCT

When human switched from hunter-gatherers into agriculture-based populations increased consumption of wheat increased the grain quality requirements. The wheat demand by 2050 is estimated at 1,300 million metric tons (MMT). Approximately 65% of all the wheat grain is used directly as human food, 21% to feed livestock, 8% as seed and the remaining 6% for other uses. Wheat production is severely limited by both biotic and abiotic constraints. Approximately 50 diseases cause economic losses vary according to region and climate. Fungi are the main and most common agents of disease among them, *Fusarium* Head blight a newly emerging disease is spreading rapidly North Eastern Gangetic plains. *In vitro* experiments conducted in Department of plant pathology to screen *Fusarium* isolates against the available fungicides in the market and also against the biological control agents. The best performing fungicide and bio-control agent were used in the field trial. The field trials conducted in November 2019 to April 2020 and November 2020 to April 2021 in UBKV, experimental farm using split-split-strip plot design. Two varieties of wheat has been used one is resistant variety HD 2967 another is susceptible variety DBW 14 both of these varieties were suitable for this

region. The chemical fungicides used in *In vitro* is tebuconazole, carbendazim, azoxystrobin, epoxyconazole and Azoxystrobin + Tebuconazole. Among these tebuconazole and carbendazim reduced the fungal mycelial growth than other fungicides. Hence these two were used in field trial as seed treatment and foliar spray. The biological control agents *Pseudomonas* sp. and *Trichoderma* sp. both these performed well in the *In vitro* experiment, so both were used in the field experiment as foliar spray and also seed treatment. The treatment combination of *Pseudomonas* sp. or *Trichoderma* sp. seed treatment and tebuconazole foliar spray is effective in terms of disease reduction and also improved growth and yield. The seed treatment with carbendazim and tebuconazole foliar spray combination reduced the disease to higher extent than other treatments.

Genome editing for climate resilience crops, an underlying genesis in crispr tool

Divakar, S. and S.Pazhanisamy

Department of Agricultural Biotechnology and Molecular Biology, Dr. RPCAU, Pusa, Bihar.

Department of Agronomy, Dr. Rajendra Prasad Central Agricultural University, Pusa, Bihar.

ABSTRACT

The term that has been perpetual and slogging this terrain for years is climate change. However, climate change is seen as major adversity to the environment (*i.e.*, flora and fauna). But with premonition, as a permanent change, it's going to hit and stay with those detrimental changes. Plants occupy an individual nexus while it comes to climate change. This changing climate is led to affect sustainable crop production. Plant's ability to reconcile these inevitable changes drives the outset to overcome abiotic stress, which includes drought, salinity, temperature extremity through these decade-old tools. The precise gene-editing tool clustered regularly interspaced short palindromic repeats (CRISPR) and its associated nucleases (Cas9) will shrink those effects and prepare plants for a foreboding change. In this era of genomics, the availability of genome sequences and advanced biotechnological tools has opened up several possibilities of directly targeting and improving the desirable given trait of all eukaryotic cells. CRISPR/Cas9 genome editing has emerged as a powerful tool among other advanced tools like ZFNs (zinc-finger nucleases), TALENs (transcription activator-like effector nucleases). Cas9 has been potentially available for use with different guide RNAs targeting multiple sites in the genome. Several modified Cas9 variants have been utilized in crops for improving target specificity and reducing off-target cleavage (*e.g.*, Cjcas9, Nmecas9, and Stcas9). With the effect of using CRISPR/Cas9 based genome editing tools and facilitates where CRISPR/Cas9 has been used to enhance biotic and abiotic stress tolerance. These fortune-bearing techniques give us a landmark in developing non-genetically modified (non-GMO) crops with the desired trait that green flags increased yield potential under biotic and abiotic stress conditions. The complementary approaches of gene editing (CRISPR tool) and the internet of things will be possible upon figured ways for resilient climate annexations.

Keywords: Abiotic stress, climate resilience, CRISPR tool, gene editing.

Effect of different cropping systems on enzymatic activities in calcareous soils of Bihar

Vivek Kumar¹, Munmun Majhi², Sanjay Kumar Singh³, Kaushal Kishor¹ and Rahul Kumar Raushan¹

¹ *Dr. Rajendra Prasad Central Agricultural University, Pusa, Samastipur, Bihar*

² *Uttar Banga Krishi Vishwavidyalaya, Cooch Behar, West Bengal*

³ *Tirhut College of Agriculture, RPCAU, Pusa, Samastipur, Bihar*

ABSTRACT

The present investigation was undertaken during at research farm of Tirhut College of Agriculture, Dholi, Muzaffarpur, a campus of Dr. Rajendra Prasad Central Agricultural University, Pusa, Bihar. In the campus area, the different kinds of cropping pattern were being practiced at same piece of land for last five years or more than five years. Each crop was grown with normal irrigation practices and recommended fertilizer application without any stress conditions. A number of soil quality parameters were measured during the course of investigation to evaluate the effect of nine cropping systems (T₁-Onion-Garlic, T₂-Tuber-Moongbean, T₃-Pigeon Pea, T₄-Rice-Potato, T₅-Mustard-Moongbean, T₆-Turmeric-Moongbean, T₇-Fallow Land, T₈-Rice-Wheat, T₉-Maize-Maize) on soil quality under similar type of calcareous nature of the soil. Soil samples at surface (0-15cm) and sub-surface (15-30cm) were collected from each treatment (cropping systems) at the end of Rabi season (Mid-April to Mid-May, 2018) *i.e.* Completion of one cropping cycle. Each cropping systems were represented by three plots with area 5 x 5 m and total of 27 (9 cropping system x 3

plots) samples were brought in laboratory for analysis. Dehydrogenase Activity and Alkaline Phosphatase Activity are the good indicators of soil microbial properties. Dehydrogenase and alkaline phosphatase enzyme showed variation from 6.87 to 19.91 ($\mu\text{g TPF g}^{-1}24 \text{ h}^{-1}$) and 6.77 to 33.55 ($\mu\text{g PNP g}^{-1} \text{soil h}^{-1}$) at the upper surface layer (0-15 cm) and 2.62 to 15.85 ($\mu\text{g TPF g}^{-1}24 \text{ h}^{-1}$) and 5.27 to 27.88 ($\mu\text{g PNP g}^{-1} \text{soil h}^{-1}$) in lower surface layer (15-30 cm) respectively. Among the cropping systems, pigeon pea maintained higher amount of Dehydrogenase and alkaline phosphatase enzyme in the soils followed by the other system and fallow land showed the lowest value. The result depicted that the legume based cropping system had better biological activity as compared to other type of cropping systems.

Studies on effect of tillage and cultivars on yield and yield attributes of rice (*Oryza sativa* L.) under conservation tillage systems

ANKIT*, SANDEEP MANUJA, SURESH KUMAR, SHABNAM KUMARI AND NIKHIL DOGRA
Department of Agronomy, CSK HPKV, Palampur (HP) 176 062

ABSTARCT

A field experiment was conducted at the Experimental Farm of Department of Agronomy of CSK Himachal Pradesh Krishi Vishvavidyalaya, Palampur (H.P.) during *kharif* 2019 to study the effect of different tillage system and varieties on yield of rice. The treatments consist of three rice varieties (viz., HPR 1156, HPR 2656 and HPR 2795) which were tested under three tillage systems viz., conventional tillage, minimum tillage without residue and minimum tillage with residue treatment. The trial was laid out in split plot design with tillage system in main plot and rice varieties in sub plot and was replicated thrice. The soil of the experimental site was silty clay loam in texture. Significantly higher number of panicle per metre square was recorded in minimum tillage without residue which was at par with conventional tillage. Number of grains per panicle and panicle length were significantly higher in conventional tillage which were at par with minimum tillage without residue. Numerically higher 1000 grain weight was recorded in conventional tillage. Among different varieties tested, HPR 2656 recorded significantly higher number of panicles per metre square which was at par with variety HPR 1156. Significantly higher number of grains per panicle and panicle length were recorded with HPR 2795 which was at par with HPR 2656. 1000 grain weight was significantly higher in HPR 1156 which was at par with HPR 2795 and HPR 2656. In case of yield, conventional tillage recorded significantly higher grain yield which was at par with minimum tillage without residue. Among different varieties tested, HPR 2795 recorded significantly higher grain yield which was at par with HPR 2656.

Strains associated with the nature of work among women tea pluckers of Assam

Alinda Kashyap¹, Dr. Manorama Devi², Dr. Shishir Kala³ and Neetu Kumari⁴

Department of Family Resource Management, College of Community Science, DR.RPCA (Pusa) Samastipur.

ABSTRACT

Assam's tea business is a agro-based industry that contributes significantly to the state's economy and has grown to become India's greatest tea-producing state. Tea being a labour-intensive industry involves majority of women in tea plucking activity as hand plucking is considered to be the appropriate type of plucking for getting better production. Women perform the plucking activity by making repetitive hand movement and tilting the body forward from natural alignment for a long time in varying climatic condition. The existing study was conducted in Dekorai Tea Estate of Assam. A total of 60 respondents were selected by following random sampling method. To elicit the information both observation and interview method were followed. The study explores that the females perform their work in usual casual postures maintaining the position for a longer period of time, causing discomfort and fatigue which leads to musculoskeletal problems and then to drudgery as the cost of energy and other muscular efforts remain unrealized. The respondents work for a total of eight hours a day and overtime if needed. Majority of the respondents (60%) plucked 60-70kgs of leaves per day and 20-30kgs in overtime (78.33%). Incidence of head ache (40%), body ache (36.66%), neck pain (36.66%), back pain (33.33%) and wrist pain (30%) were highest among the respondents. On an average 71.67 percent of respondents encountered difficulties while participating in tea plucking activity which means that there is need of intervention to improve health and wellness of the women tea pluckers of Assam.

Key words: Women tea pluckers, strain, health hazards, pain

Impact of Climate Change on Soil Structure and Properties in the Himalayan Region

Anil Kumar*, Manju Kandpal,

*Department of Chemistry, IPGGPG College of Commerce, Haldwani
(Nainital)263139*

ABSTRACT

The impact of climate change on soil is a slow process. The effect on soil are expected mainly through alteration in soil moisture conditions and increase in soil temperature, CO₂ levels as a result of climate change. The Himalayan region like Kumaun is the more vulnerable in view of tropical climate and poor cropping capacity of the small and marginal farmers. Climate change is projected to have significant impacts on regional (Kumaun) agriculture area though direct & indirect effects on crops, soils, livestock and pests. In the light of these concerns, the impact of climate change have been discussed. This paper deals with the study of soil and impact on soil due to climate change with important implications for their development, use, soil structure, stability, water-holding capacity, nutrient availability and erosion in Kumaun region.

Plant biodiversity enhances bees and other pollinators in agro ecosystems

Mohammad Rizwan¹, Mohammad Imran², S.K. Sachan³, Nazim Ali⁴

^{1,3}Department of Entomology, S.V.P.U.A. & T, Meerut- 250110 (U.P.)

²Department of Genetics and Plant Breeding, S.V.P.U.A. & T, Meerut- 250110 (U.P.)

⁴Department of Animal Husbandry, S.V.P.U.A. & T, Meerut- 250110 (U.P.)

ABSTRACT

There is growing evidence that ecosystem services, such as biological pest control and crop pollination, benefit food production. Indeed, 75% of the crop species used for food depend on insect pollination to some degree. More than a decade of active pollination research has led to a greatly improved general understanding on animal pollination benefits to crop yields worldwide. First, we have surprisingly little information on the actual degree of pollinator dependence for some major crops. While some crops depend entirely on insect pollinator visits to set fruit, many others are only partly dependent on animal pollination and can produce more than 90% of the maximum seed or fruit yield without pollinators. The role of pollinators for crop production has mainly been examined in observational studies, relying primarily on natural variation in visitation rates among observed sites. Experiments directly manipulating insect flower visitation (e.g., excluded pollinators vs. open access of pollinators) are less common for most crops. Assessing pollination dependence with proper controls is needed to correctly estimate the contribution that insect pollinators can provide to crop yields.

Application of information and communication technology in agriculture

Gargi Paliwal¹; Dr.D.K. Singh²; Samarjeet Singh³

¹ Agricultural Communication; Govind Ballabh Pant University of Agriculture & Technology, Pantnagar-263145, Uttarakhand., India

² Department of Agricultural Extension & Communication; Sardar Vallabhai Patel University of Agriculture & Technology, Meerut-250110, U.P., India

³ Department of Agricultural Extension & Communication; Sardar Vallabhai Patel University of Agriculture & Technology, Meerut-250110, U.P., India

ABSTRACT

Agriculture plays an important role in the social and economic development in our country and is considered as the main contributor to economic growth and stability. Information and Communication Technology is an emerging field which focuses on the enhancement of agricultural and rural development and is defined as technologies that are used to interlink information technology devices such as personal computer, slide projectors, television, digital camera, with communication technologies such as telephone and the telecommunication networks which enable the users to

3rd International Conference on “Global Initiative in Agricultural, Forestry and Applied Sciences for Food Security, Environmental Safety and Sustainable Development (GIAFAS-2021)”

store, transmit, access and manipulate information. Application of new information sources is a crucial requirement for the achievement of sustainable development of the farming system. National e-Governance plan indicated that the typical services envisaged in Agriculture as a Mission Mode Projects (MMP) to provide information to the farmers on government schemes, crop management, seeds, fertilizers, pesticides, weather and marketing of agricultural produce. Projects such as Pusa-Krishi, Kisan Sarathi, launched by ICAR and ASHA in Assam, e-Krishi in Kerala, and KISSAN in Karnataka etc. have been initiated by the Department of Agriculture and Cooperation, Government of India. In most of the ICT initiatives information flow was one-way that resulted in limited scope for interaction between farmers and scientists but Projects such as Digital Green, Village Resource Centre, e-Arik, e-Sagu, e-seva, provides opportunities for interaction among farmers and experts. ICT are going to play greater role in private sector such as agribusiness and market intelligence. ICT helps in enabling farmers to make better decisions about future crops and commodities through accurate and reliable information that reaches the farmers at the right time.

Keywords: ICT, Application.

Indian traditional methods of water storage and purification for a healthy life

S. Nikil and A. Bharani***

**Dept. of Environmental Science*

Tamil Nadu Agricultural University

***Dept. of Physics, PSG College of Arts and Science*

ABSTRACT

Water as we all know it, is the “ELIXIR OF LIFE”. There have been many struggles for water in the human history. Only those who harnessed water in a proper manner thrived while the others who failed became a victim of their own misstep. Water scarcity is prevalent in many parts of India and we believe that no one in this world should fight over a bottle of water. People depend only on the naturally available water resources viz., lakes, ponds, rivers, etc. Since there aren't any alternate sources of water, in the absence of sufficient rainfall, their livelihood becomes questionable. Statistics say that, today in the urban areas of India 7 in 10 people can count on having running water in their homes. There is no proper awareness among the people on how to harness water and save it for future use. We believe that through our paper we would be able to let the Indian people about their own traditional methods of water storage and conservation.

Various literatures have been used as a reference for this paper, to name a few:

- Traditional Water Harvesting Structures and Sustainable Water Management in India: A Socio-Hydrological Review by Sayan Bhattacharya (International Letters of Natural Sciences)
- A Review of Indian Traditional Method of Rain Water Harvesting (International Journal of Innovative Research in Science, Engineering and Technology)

In addition to this a few articles from the Centre of Science and Environment and International Water Association archives have been used as a reference.

Without any proper guidance and awareness among the people, conservation of water will be an arduous task. The adoption of water conservation measures marks the upliftment of the community and enhances the livelihood for a better future. Start conserving water by just closing the taps after use so that you don't fight over a bottle of water. To conclude, our environment has lost its purity both physically and culturally over a period of time. The technological advancements and developments stand directly proportional to the human that has activities caused a few drastic changes in the ecological aspect of societies. In our country like India, many policies developed for water resources management are either directly or indirectly dependent on the traditional knowledge developed in the ancient age that has taught us the value of a simple life. The traditional water wisdom ensured adequate availability of water for all. The necessity to learn and comprehend our ancient knowledge to apply it in our modern society is the need of the hour to evade water stress conditions.

Hence, let us revive and expand our highly valued and old wisdom for the benefit of all our people especially in the rural area. Yes, we can do it. Let us join hands for this common cause and never ever forget our ancestors and their traditional knowledge though we are in the digital era.

Key Words: water scarcity, alternate sources, livelihood, water conservation measures

Evaluation of granular insecticides against yellow stem borer and leaf folder in rice

S. S. Thorat*, R. K. Gangwar, M. B. Parmar, D. B. Prajapati, S. G. Patel and D. J. Kacha

Main Rice Research Station, Anand Agricultural University, Nawagam, Kheda (Gujarat)-387 540, India

ABSTRACT

The experiment was conducted at Main Rice Research Station, Anand Agricultural University, Nawagam, Gujarat during *kharif*, 2020 in randomized block design and three replications of seven treatments. Thirty days old seedlings of rice variety GR 11 were transplanted to main field with spacing of 20 × 15 cm. the first treatment was applied at initiation of insect-pest and second at 15 days after first application. Before application, granular insecticides were mix with the sand. The 25 kg sand per hectare were used to mix the granular insecticides. The standing water in the field were not more than 1 to 2 cm. Observations on infestation of yellow stem borer in terms of dead hearts (DH) and leaf folder in terms of damaged leaves (DL) were recorded before first application, 7, 10 and 14 days after each application and white earheads (WE) at 15 days before harvest from five randomly selected hills in each treatment. Then percentage of dead heart, white ears and damaged leaves were calculated. The crop was harvested at maturity and grain as well as straw yield was recorded separately from net plot area of each treatment. The data on per cent dead heart, white earheads, damaged leaves, grain and straw yield were subjected to ANOVA. The present investigation on the importance of yellow stem borer and leaf folder indicated that the plot treated with chlorantraniliprole 0.4 GR, 40 g a.i./ha, chlorantraniliprole 0.5 + thiamethoxam 1.0 GR, 90 g a.i./ha and thiocyclam hydrogen oxalate 4 G, 500 g a.i./ha were found more effective for management of yellow stem borer and leaf folder with higher grain and straw yield.

Grain amaranth (*Amaranthus hypochondriacus* L.) yield and economics under sulphur fertilization in rainfed hilly region of Garhwal Himalayas

Rahul Rana, Arunima Paliwal*, Ajay Kumar, Shikha¹ and Gargi Goswami²

College of Forestry, VCSG Uttarakhand University of Horticulture and Forestry, Ranichauri, Tehri Garhwal, Uttarakhand, India

²*College of Horticulture, VCSG Uttarakhand University of Horticulture and Forestry, Bharsar, Pauri Garhwal, Uttarakhand, India*

¹*Krishi Vigyan Kendra, Tehri Garhwal, Uttarakhand, India*

ABSTARCT

Grain amaranth (*Amaranthus hypochondriacus* L.) a nutriceal, is one of the disremembered food crops of the world. It has potentiality as subsidiary food and plays a vital role in feeding the hunger world. They are protein rich pseudo-cum-nutri cereals and also called as poor man vegetable, that holds cultural significance in remote and tribal areas in many part of India particularly in the Himalayan region. The most important constraints to crop growth are those caused by poor variety selection and improper plant nutrients. Improved varieties with nutrient management practices could improve the productivity of grain amaranth. Thus, a field study was conducted during *Kharif* season of 2018 and 2019 at Research and Extension Center, Gaja, College of Forestry, VCSG Uttarakhand University of Horticulture and Forestry, Ranichauri, Tehri Garhwal, Uttarakhand, India to investigate the response of sulphur fertilization on yield attributing, seed yield and economics of grain amaranth. Two varieties and four fertilizer doses were tested in split plot design with three replications. The data indicated that among the varieties, PRA-3 performed well as compared to Annapurna. The PRA-3 variety showed 21.05 and 15.31% increase in pooled grain yield and straw yield, respectively over Annapurna and gave high net profit and benefit cost ratio. However, RDF with 20 kg/ha sulphur showed increase of 74.42 and 58.92% in pooled grain yield and straw yield, respectively over control and increase of 26.05 and 29.17%

3rd International Conference on “Global Initiative in Agricultural, Forestry and Applied Sciences for Food Security, Environmental Safety and Sustainable Development (GIAFAS-2021)”

over recommended dose of fertilizers, respectively along with highest net profit and benefit cost ratio. Thus, it is concluded that PRA-3 cultivar is most economical high yielding cultivar of grain amaranth with the application of 20 kg sulphur/ha along with RDF (60:40:20) and may be recommended for rainfed conditions of Garhwal hilly region of Uttarakhand.

Biomimetic textiles: An innovative approach towards conserving the future

Pratikhya Badanayak^{1*} and Jyoti V. Vastrad¹

¹Department of Textile and Apparel Designing, College of Community Science, University of Agricultural Sciences, Dharwad, Karnataka, India- 580005.

ABSTRACT

Nature has developed over billions of years to generate more efficient solutions than comparable man-made solutions in the field of textile, such as superhydrophobicity, self-cleaning, self-repair, energy conservation, drag reduction, dry adhesion, adaptive growth, and so on. There are many examples of functional surfaces, fiber structures, structural colours, self-healing, thermal insulation, and other features that can be applied to future textile products. Biomimetic research is a rapidly expanding field, and the ultimate potential of the issue in the production of novel and sustainable textiles can only be achieved through multidisciplinary study based on a holistic understanding of nature. In this paper, an insight looks at the potential bio-inspired textile structure was addressed to the greatest extent possible. Furthermore, the future usefulness of various biomimetic textiles was discussed. Essentially, this discipline can serve as a source of inspiration for ongoing material progress. Biomimicry has the ability to improve manmade materials and pave the way for the next generation of technical, high-performance materials, ranging from novel materials and properties to innovative structures and designs, as well as product and process sustainability.

Keywords: Biomimicry; innovative textiles; natural approach; biomimetic textiles; next generation technology

Environmental challenges and sustainable development

Rahul Kumar Maurya, Ashish Kumar, Niyaz Ahamed and D.K. Dwivedi

Department of Plant Molecular Biology & Genetic Engineering Acharya Narendra Deva University of Agriculture & Technology, Narendra Nagar (Kumarganj), Ayodhya-224229 (U.P.), India

ABSTRACT

Nowadays environmental destruction directly affects the economic process of world countries. Erosion, ozone layer's becoming thin, pollution, increasing the number of dangerous flooding due to the destruction of settlements and climate changes altogether have a bad effect on people's lives. The worst impact of non-standardized economic development is the contamination of air, water, and soil. Sustainable development ensures responsible interface with the environment to minimize the depletion or degradation of natural resources and ensure long term environmental quality. Sustainable development that causes the conservation of lands, water, genetic, plant, and animal resources not only is not the destructor of the environment, but also is suitable technically, worthwhile economically, and acceptable socially. While reserving environment and natural resources is among the most important human challenges in the turn of the new century, the necessity of improving the level of life standards in the developing countries still keeps its importance. Environmental sustainability and development are two essential elements in development planning, and in order to enjoy sustainable development we should firm industrial development based on the concept of environmental sustainability. Some parts of environmental consequences and damages are the results of unclear regulations and their lack of administrative guarantee. The process of globalization due to the lack of preparing essential provisions for compensating the results of its avarice at last leads to destroying environment and earth's natural resources and increasing poverty under the yoke of the world capitalism.

Key words: Environment, Sustainable development, Developmental Punishment, Globalization

Efficacy of herbicides on weed dynamics and seed yield of finger millet (*Eleusine coracana* (L) Gaertn.)

Amit Kishore, Ajay Kumar, Arunima Paliwal, Bhim Jyoti, Sumit Chaudhary and Kanchan Harbola
College of Forestry, VCSG Uttarakhand University of Horticulture and Forestry, Ranichauri-249199, Tehri Garhwal, Uttarakhand, India

ABSTRACT

A field experiment was conducted during *Kharif*, 2018 at Gaja, Research and Extension Centre, College of forestry, VCSG Uttarakhand University of Horticulture and Forestry, Ranichauri, Tehri Garhwal, Uttarakhand, India to study the influence of different herbicidal treatments on weed dynamics and seed yield of finger millet. The experiment consist of 11 treatments, having T1-oxadiargyl 80 WP at 150g a.i./ha (within 3 DAS)+ one IC at 25 to 30 DAS, T2-oxadiargyl 80 WP at 200g a.i./ha (within 3 DAS)+ one IC at 25 to 30 DAS, T3-bensulfuron methyl 0.6 G + pretilachlor 6.0 G @ 0.165 kg a.i./ha (within 3 DAS)+one IC at 25 to 30 DAS, T4-bensulfuron methyl 0.6 G + pretilachlor 6.0 G @ 0.33 kg a.i./ha (within 3 DAS)+one IC at 25 to 30 DAS, T5-butachlor 50 EC 750g a.i./ha (within 3 DAS)+one IC at 25 to 30 DAS, T6-bispyribac sodium 10 SC 10g a.i./ha (within 15-20 DAS)+one IC at 35 to 40 DAS, T7-bispyribac sodium 10 SC 15g a.i./ha (within 15-20 DAS)+one IC at 35 to 40 DAS, T8-ethoxysulfuron 15 WG 12g a.i./ha (within 15-20 DAS)+one IC at 35 to 40 DAS, T9-ethoxysulfuron 15 WG 15g a.i./ha (within 15-20 DAS)+ one IC at 35 to 40 DAS, T10- One IC with one hand weeding at 20 & 40 DAS and T11-unweeded check. The experiment was executed in randomized block design with 3 replications. The finger millet crop was sowing on June/11/2018 and harvested on Oct/31/2018.

The experimental field of finger millet was pre dominantly infested by *Eleusine indica*, *Digitaria sanguinalis* among grasses and *Galinsoga parviflora*, *Persicaria capitata*, *Commelina benghalensis*, *Oxalis latifolia*, *Datura stramonium*, *Bidens pilosa*, *Ageratum conyzoides* among the broad leaved weeds. The significantly lower grassy and broad leaved weed density along with total dry weight and higher weed control efficiency were recorded in bispyribac sodium 10 SC 15g a.i./ha (within 15-20 DAS)+one IC at 35 to 40 DAS at all stages in comparison with unweeded check and statistically at par with bispyribac sodium 10 SC 10g a.i./ha (within 15-20 DAS)+ one IC at 35 to 40 DAS. The significantly higher seed yield were recorded in early post emergence application of bispyribac sodium 10 SC 15g a.i./ha+ one IC at 35 to 40 DAS. This treatment registered 43.8 % higher grain yield than the unweeded check.

Legume protease inhibitors (pi's) for curtailing insect pest menace

Ankur Tripathi¹, Rabiya Basri², Shailesh Kumar Singh³, Shama Parveen⁴, Nitika Nehal⁵
^{1, 2, 3, 4, 5} School of Agriculture, ITM University, Gwalior (MP), 474001

ABSTRACT

Infestation of insects seriously affects the total crop production and to counter this obstacle, insecticides are being used indiscriminately and injudiciously and leading to insect resurgence and resistance, adverse effects on beneficial insects and consequential environmental hazards. These repercussions are raising several questions on agrochemical based management strategies which are demanding their replacement with eco-safe and effective strategies. Scientists have conceded the importance of exploiting plant intrinsic defense mechanism in devising the new and effective strategies to curtail insect pest menace. Plant inhibitory acting independently or in combination, constitute a complex network of plant defense system, of which protease inhibitors (PI's) have been proved as important constituent. PIs due to their competitive inhibitory nature, they act as pseudo substrate and form a stable stoichiometric complex with proteases and block their activity. Upon feeding, the binding of PIs with digestive proteases in GI tract of phytophagous insect block the protein digestion and leads to the deficiency of essential amino acids and energy which are crucial for growth, fecundity and ultimately for insect survival. Normally these are expressed invariably in different parts, but they synthesize in higher concentrations in response to insect predation. PIs form legumes have been extensively investigated. They constitute major proportion of total soluble proteins in seeds. According to proteases catalytic activity, PIs have been classified into four classes (Serine PIs, Cysteine PIs, Aspartic PIs, and Metalloprotease PIs) based on specific amino acid in their catalytic center. Serine PI's are widely present in legumes and are of two types.

3rd International Conference on “Global Initiative in Agricultural, Forestry and Applied Sciences for Food Security, Environmental Safety and Sustainable Development (GIAFAS-2021)”

BBI type legume PIs are of about 8-16 kDa m. wt. with trypsin and chymotrypsin catalytic centers whereas Kunitz type PIs are of about 20-25 kDa m. wt. with only trypsin catalytic center. Legume PIs have superior stability and superior inhibition activity against proteases from microbial and animal origin in comparison to plants PIs. Several studies have confirmed their inhibitory action against insects belonging to different orders. Mostly legume PIs are single gene product and their encoding region are small and usually intronless, thus can be correctly transcribe and translate inside the host plants. Moreover, they are heat labile and can be easily inactivated by cooking. For these reasons, legume PIs could be a promising agent to develop transgenic plants with improved resistance. Additionally, identification of new PI's from wild and/or underutilized legumes would not only increase the defense gene pool but also provide opportunities for designing strategies for multigene transfer in order to increase insect resistance in economic crops.

Keywords: Insect-pest menace, Legumes, protease inhibitor, insect resistance, Transgenic

Edible coatings with active agents for shelf-life extension in fruits and vegetables

Sadaf Ahmad^{1*}, Nazia Tabassum²

¹ University Polytechnic, Aligarh Muslim University, Aligarh-202002, Uttar Pradesh, India

² Department of Post Harvest Engineering and Technology, Aligarh Muslim University, Aligarh-202002, Uttar Pradesh, India

ABSTRACT

Edible coating could be the most favorable method for maintaining the condition of fresh-cut fruits and vegetables. These are thin layers of edible material applied to the surface of fruits and vegetables in addition to or as a replacement for natural protective waxy coatings and provide a semi-permeable barrier to moisture, gases (oxygen and carbon dioxide), flavour, odor and solute movement. They also improve mechanical properties, thus delaying the natural senescence, minimizing water loss and keeping the structural integrity of coated product intact. Moreover, they are eco-friendly and biodegradable. On the basis of the materials used to prepare them, edible coatings are classified as hydrocolloids (polysaccharide, proteins), lipids (Fatty acids, waxes) and composites combination of proteins, polysaccharides, and lipids.

Various active ingredients, such as antimicrobial and antioxidant agents, texture enhancers, or nutraceuticals can help improve the quality and storage life of fresh-cut fruits when incorporated in edible coatings. These additives serve to modify the physicochemical properties or other functionalities of coatings. Essential oils such as eugenol, oregano, thyme, lemongrass, etc. have been incorporated mainly for their antioxidant and antimicrobial properties. Ascorbic acid and carboxylic acids, such as citric acid and oxalic acid etc. and cysteine, N-acetylcysteine and glutathione are being used as antibrowning agents. The calcium ions are known to interact with pectic polymers to form a cross-linked network, which improves mechanical strength and texture in fruits and vegetables. Nutraceuticals are being explored to enhance the nutritional value of some fruits and vegetables, low in micronutrients with minerals, vitamins and fatty acids. All these studies indicate the tremendous potential of active ingredients incorporated in edible coatings for improving the shelf lives of fruits and vegetables. More research is needed to establish their effects on functional, barrier and mechanical properties of the food products.

Keywords: edible coatings, active ingredients, antioxidants, antimicrobials, essential oils

Habitat Management of Green lacewings: A Potential Biocontrol Predator in Agroforestry System

Tanmaya Kumar Bhoi^{*1}, Sangeeta singh¹ and Shiwani Bhatnagar¹

¹ Arid Forest Research Institute, Jodhpur, Rajasthan, 342005

ABSTRACT

Green lacewing, *Chrysoperla zastrowi sillemi* (Esben-Peterson) family Chrysopidae and order Neuroptera are examples of predatory insects in agroforestry systems. This predator has great predation potential and can prey on a variety of pests, such as whiteflies, aphids, thrips and cotton bollworm eggs. Due to a high degree of disturbance, many

3rd International Conference on “Global Initiative in Agricultural, Forestry and Applied Sciences for Food Security, Environmental Safety and Sustainable Development (GIAFAS-2021)”

agricultural ecosystems are unfavourable for these natural enemies. Habitat management is a form of protective biological control. It is an ecologically-based method designed to benefit natural enemies and strengthen biological control in agroforestry systems. The goal of habitat management is to create a suitable ecological infrastructure to provide resources such as food for adult natural enemies, alternative prey or hosts, and to provide shelter from adverse conditions for the green lacewings.

Keywords: Green lacewings, habitat management, predators, natural enemies

Information communication technology in agriculture

Akanksha Sharma¹, Babita Baghel²

Department of Agricultural extension and Communication, RVSKVV, Gwalior (M.P.)¹

Department of Agricultural Economics, RVSKVV, Gwalior (M.P.)²

ABSTRACT

Agriculture sector play a vital role in global economy and in India most of the Rural population depends on agriculture Information and communication technology in agriculture (ICT in agriculture), also known as e-agriculture. In the context of agriculture, the potential of information & communication technology (IT) can be studied under broadly two outcomes such as direct and indirect contribution to farm productivity. Result of direct contribution of agriculture technology for farm productivity is Precision farming and on other hand indirect tools helps farmers to take informed and quality decisions which will have positive impact on the agriculture and allied activities are conducted. Indian farmers need urgently, timely and reliable sources of information inputs for taking decisions. The problem of Indian agriculture is not lack of technology, R&D efforts but inadequacy and inefficiencies in the dissemination of information to the farmers. Agriculture automation is being a game-changer in other countries; So for the past few years, these technologies is being used in developed countries to satisfy the requirements of food production but our country is still trying to adopt these technology completely. Indian government has also realized the importance of these and started to leverage this technology in the developing sector. Once we adopt and use the Artificial intelligence to agriculture we will not only succeed in food production but also it can provide employment opportunities to many people. ICT based equipment and machines, has taken today's agriculture system to a different level. e-Research (e-Science) draws on increasingly connected and extensive digital infrastructure to facilitate collaboration and knowledge exchange nationally, regionally, and globally On a macro level and On a micro level, m-Agriculture, powered by increasingly affordable mobile digital devices such as phones, laptops, and sensors, connects millions of rural people to sources of information. In India ICT applications such as E-Chaupal, E-Seva, e-Extension, AGRISNET, AGMARKNET, Agri Business Centres, e-KRISHI VIPANAN, Query Redress Services, Kisan Call Centres, Tata Kisan Kendra, AKASGANGA are quite successful in the communication of information. These technologies have enhanced productivity and improved harvesting, processing, real-time monitoring and marketing. The applications of ICT combined with other ICT systems or ICT itself results in productivity improvement and better resource use and reduces the time needed for farm management, marketing, logistics and quality assurance.

Farm mechanization and post harvest technologies to enhance farm profitability

Babita Baghel , Akanksha Sharma

1 Department of Agricultural Economics, RVSKVV, Gwalior (M.P.)

ABSTARCT

Farm Mechanization technology plays a vital role in enhance agricultural productivity in developing countries and should be considered as an essential input to agriculture. “Farm Mechanization” term is used and describe as an overall description of the application of the variety of tools, equipment, implements, machinery, power & other mechanical inputs. Farm mechanization in India is still in its derived stages and during the last two decades have been able to achieve a scanty growth of less than 5%. Farm Mechanization face critical challenges in terms of large share of small and marginal farmers, declining land high cost of farm machinery ,holding sizes and equipment, inappropriate technology, complex operations, undeveloped markets, insufficient policy framework and maze of legislation, cropping

3rd International Conference on “Global Initiative in Agricultural, Forestry and Applied Sciences for Food Security, Environmental Safety and Sustainable Development (GIAFAS-2021)”

pattern, Land size, market price of crops including Minimum Support Price (MSP), availability of labour and cost of labour are the major factors deciding the growth of agricultural mechanization in India. In 2014 The global farm machinery and agriculture market was valued at US \$ 144.10 billion and is forecasted to grow at a compounded annual growth rate (CAGR) of 8.7% from 2015 to 2022 as per global syndicated reports published in 2015. High demand for farm tractors and harvesting machinery is expected to spur the overall market growth. Though mechanization has improved the agriculture in certain parts of the country, it is still base of the pyramid story and it will remain so unless concrete measures are taken to propel farmers towards adoption of efficient farm mechanization practices. Custom Hiring is the only practical way to introduce capital intensive, high quality mechanization to the small farming structures prevalent in India. Mechanization interventions have been reported to increase the productivity by 15% and reduce the cost of production to the tune of 20%. The mechanization also facilitates conservation and sustainable agriculture while improving the livelihood opportunities, income and environmental sustainability.

Weed dynamics and wheat performance as influenced by different fertility levels and herbicides

Sarita^{1*}, Ishwar Singh² and M.L. Mehriya²

¹College of Agriculture, Agriculture University, Jodhpur-342304 (Rajasthan), India

²Agricultural Research Station, Mandor-342304, Jodhpur (Rajasthan), India

ABSTRACT

Wheat is a significant source of water soluble protein has a good dietary fiber content and is rich in vitamins (mainly B-group vitamins such as thiamin, riboflavin and niacin) and minerals (magnesium, potassium, calcium, iron, zinc and selenium). Nitrogen and phosphorus are important plant nutrients; plays a key role in agriculture by increasing of crop production and food quality by increases photosynthetic processes, leaf area production as well as net assimilation rate. Production of wheat crop is directly affected by several biotic and abiotic factors. Among these, one of the most limiting constraints is the weeds infestation. Continuous use of herbicides of the same site of action resulted in multiple herbicide resistance. A mixture of more than one herbicide is essential to the effective management of multiple weed flora. Herbicide combinations not only enhance weed control efficacy, they are also convenient in delaying herbicide resistance. Therefore, a two year field experiment was conducted in *Rabi* season of 2018-19 and 2019-20 at College of Agriculture, Jodhpur, Rajasthan. Results revealed that significantly minimum weed dry weight was recorded with 75% RDF (90-30 kg N-P₂O₅/ha). Application of 100% RDF (120-40 kg N-P₂O₅/ha) recorded significantly higher weed dry weight at harvest growth and yield attributes *i.e.* plant height, crop dry matter accumulation (g/meter row length), number of grains/spike, grain yield, straw yield and biological yield over 75% RDF. This treatment remains at par with 125% RDF (150-50 kg N-P₂O₅/ha). Among the herbicidal treatments, application of ready-mix herbicides clodinafop-propargyl 15% + metsulfuron methyl 1% @ 64 g/ha gave the superior value of weed indices *i.e.* higher weed control efficiency and lower weed index over other herbicides. This treatment also exhibited significantly higher plant height, crop dry matter accumulation g/meter row length), crop growth rate number of grains/spike, grain yield, straw yield and biological yield over weedy check plot, which was followed by sulfosulfuron 75% + metsulfuron methyl 5% @ 32 g/ha, both of which remained statistically at par with each other except number of grains/spike.

Key word: Fertility levels, Herbicides, Wheat and Weed control efficiency

Protection of Plant Varieties and Farmer Rights Act and its role in Germplasm Collection

Bonani Kakoty^{1*} and Alongber Basumatary²

¹Assam Agricultural University, Jorhat-785013, Assam,

²Dr Rajendra Prasad Central Agricultural University, Pusa, Samastipur- 848125, Bihar, India

ABSTRACT

The “Protection of Plant Varieties and Farmers’ Rights Act” is a special Act which follows the provisions of the UPOV 1978 Convention and satisfies the ethos of the International Treaty on Plant Genetic Resources for Food & Agriculture. The Government of India enacted the Act in 2001, for the establishment of an effective *sui generis* system for the protection of plant varieties, the rights of farmers and plant breeders, and to encourage the development of new plant varieties of economic importance. It strikes a balance between the rights to breeders and the farmers as per the national requirement. PPVFRA not only regulates the intellectual property regimes on plant varieties in India, but it also protects

3rd International Conference on “Global Initiative in Agricultural, Forestry and Applied Sciences for Food Security, Environmental Safety and Sustainable Development (GIAFAS-2021)”

the rights of the plant breeders as well as the farmers as it is the only Authority in the World to protect both inventor (the plant breeder) and user (the farmer) under one umbrella.. PPV&FR Authority has finalized the distinctiveness, uniformity, and stability test guidelines for registration of 158 crop species covering cereals, pulses, millets, oilseeds, spices, vegetables, flowers, medicinal and aromatic plants and fiber crops and 3 more crop species for varieties under extant categories totaling to 161. The issuance of registration certificates started in 2009 and by the end of 2020, a total of 17282 applications have been received for registration under different categories by individual farmers as well as institutes and a total of 4052 Certificates have been issued, out of which 617 have been issued for new varieties, 1707 for extant varieties notified under the Seeds Act, 1966, 1716 for farmers’ varieties and 14 for Essentially Derived Variety (EDV). Registration certificates were issued to public research organizations /SAUs, private seed companies, and individual farmer/farming communities. PPVFRA provides protection of plant varieties and also prevent unauthorized use of plant varieties or other germplasm resources thus fending off their unwise exploitation. In this way, this act ensures conservation of valuable germplasm. Crop wise, PVP applications has been dominated by varieties of cereals every year and rice figured in almost all of them. An increase has also been found in breeder seed production and distribution of quality seeds in the country. The current study provides information and insights about the PPVFRA and its impact on the plant variety development, germplasm diversification and their conservation.

Keywords: Cereal, Conservation, Germplasm, Protection of Plant Varieties and Farmers’ Rights Act, *Sui Generis*

Endophytes and their role in sustainable agricultural practices

Akanksha Rathore^{1*}, Neerja Rana¹ and Ranjna¹,

¹*Dr Y.S.Parmar university of Horticulture and Forestry, Nauni, Solan, 173230,*

ABSTRACT

Agricultural practices are under pressure to provide higher yields to feed the world’s growing population. The intensification of agriculture caused by population growth is largely achieved through the use of agricultural equipment, high-yield crop varieties, intensive farming, irrigation, fertilizers, pesticides, and other manufacturing inputs. However, the extensive use of chemical fertilizers in crops makes the country independent in terms of a large amount of food supply, but on the other hand, it has adverse effects on the environment, human and animal health, and agricultural practices. Therefore, new ecological methods must be adopted to maintain sustainable agricultural production and overcome threats. Microorganisms can directly or indirectly reduce the damage caused by pathogens or environmental pressure to have beneficial effects on plants by improving crop or plant nutrition. Endophytes are ubiquitous and have been found in all plant species studied so far. They can benefit host plants by preventing pathogens or parasites from colonizing host. Due to its great impact on different crops or plants, it is considered the best substitute for different agrochemicals used in agriculture. Endophytes are asymptomatic microorganisms (mainly bacteria and fungi) in plants. Endophytic microorganisms are usually functional because they can carry nutrients from the soil to plants, regulate plant development, increase plant resistance to stress, inhibit virulence of pathogens, increase resistance to plant diseases, and inhibit the development of competing plant species. Recent estimates indicate that there are approximately 300,000 plant species in the world, most of which are colonized by microbial endophytes. Endophytic microorganisms have been separated from different parts of the plant, such as scale primordia, meristems, and resinous leaf segments with midribs and roots, as well as stems, bark, leaves, petioles, and buds. Endophytic microorganisms have been proven to: (a) obtain nutrients in soils and transfer them to plants in the rhizophagy cycle and other nutrient-transfer symbioses; (b) Promote plant growth and development; (c) reduce oxidative stress of hosts; (d) protect plants from disease; (e) discourage herbivores from eating; and (f) suppress or inhibit the growth of competing plant species. Therefore, the use of agricultural practices that maintain the natural diversity of endophytes is becoming an important part of sustainable agriculture, which can ensure plant productivity and agricultural production quality. Diverse endophytic microbial communities play an indispensable and unique role in the function of agricultural ecosystems. Endophytes have been shown to have a variety of beneficial effects on their host plants, including growth-promoting activity, regulation of plant metabolism, and phytohormone signalling that leads to adaptation to abiotic or biotic environmental stresses. The use of endophytes is of particular importance for the development of agricultural applications, which can ensure better crop performance under cold, draught or contaminated soil stress conditions or enhanced disease resistance. Due to the effective functions of endophytic microorganisms, we believe that endophytic microorganisms can significantly reduce the use of agrochemicals (fertilizers, fungicides, pesticides and herbicides) in crop planting. In the process of domestication and long-term cultivation, the loss of endophytic microorganisms in crop plants can be compensated by transferring endophytic micro-organisms from wild relatives of crops to crop species. By selecting successful and capable endophytes, plants act as a true "filter" for the microbial community living in the soil. Endophytes are an ecological alternative to PGP and a sustainable repository of new biologically active compounds. The rapid increase in

3rd International Conference on “Global Initiative in Agricultural, Forestry and Applied Sciences for Food Security, Environmental Safety and Sustainable Development (GIAFAS-2021)”

research related to endophytic microorganisms makes them the focus of attention and bring them into spotlight. Keeping in view the biological potential and its role in the growth and development of plants, it is necessary to explore endophytes in the future to achieve environmental sustainability and agricultural productivity, and as a source of new novel biomolecules for different aspects related to growth and development of the plants and can also be used as human and industrial health sectors for the betterment of whole world.

Eminence attributes of okra (*abelmoschus esculentus* L. Moench) pods as pretentious by cultivar and fruit size

Tanu shiri^{1*}, Shailendra S. Gaurav¹, S.K. Singh² and S.Jain¹

^{1,2} Department of Genetics and Plant Breeding, C.C.S. University Campus, Meerut-250004, UP

ABSTRACT

Okra is a vegetable widely grown in the tropics, sub-tropics and warmer areas of the temperate zones. Fruit quality plays an important role in marketability and it is mainly related to the characteristic pod length. This work was intended to classify okra fruits belonging to different genotypes according to their length and to compare certain quality attributes. Some genotype of okra fruits was considerably firm although they were smaller, thus they should be more suitable for canning or pickling. The hybrid material yielded high quality fruits. These fruits may be destined for fresh consumption, given that they showed lower fibrousness. At the same time, they had high dry matter content, being suitable for dehydration. Okra fruits highlighted for their contribution of phenolic compounds. Total phenols levels significantly increased with fruit size in okra fruits, meanwhile no significant difference was observed for some okra samples. Total flavonoids content showed a similar tendency although values did not differ significantly. Total flavonoids represented between 18-22% of the total phenols contents for the analyzed samples.

Keywords: Vegetables, phenols and flavonoids.

A green and facile approach for Anti-inflammatory potency of *Ficus subincisa* Fruit

Abha Shukla, Priyanka Pokhriyal and Supriya Dubey

¹Kanya Gurukul Campus, Gurukul Kangri, Haridwar-249404, Uttarakhand, India

ABSTRACT

The Ficus plants as divine and material resources have been documented globally. *Ficus subincisa* Buch.-Ham. Ex Sm. is Ficus species found in Asia - northern India, southern China, Myanmar, Laos, Thailand, and Vietnam. *Ficus subincisa* is used in anti-helminthic as traditional medicine. *Ficus subincisa* belongs to the Moraceae family comprising approximately 850 species. Various Ficus species have been used as ethnopharmacological for the treatment of many health-promoting effects. With increasing economical and ecological concerns, for several chemical processes, green chemistry is providing various kinds of “green” solvents that can be a recruit for the extraction and isolation of numerous alleviative important phytoconstituents from plants. The present study was undertaken to prepare crude extracts of *F. subincisa* fruits with the different polarities of green solvents (d-limonene, isopropyl alcohol, ethyl lactate, and hydroalcohol) by using a modified magnetic stirrer extraction method and assessing *in vitro* anti-inflammatory activities by the spectrophotometric method. At a concentration of 1000 µg/mL, the hydroalcohol of fruit extract produced 97.53±1.23 µg/mL inhibition of HRBC hemolysis and as compared with standard drug aspirin. However, there has been no report on the anti-inflammatory activity of *F. subincisa* fruit. Therefore this study aimed to evaluate the anti-inflammatory activity of *F. subincisa* fruit extracts of different green solvents. Our study validated the traditional claim with pharmacological data of the Ficus genus. These results suggest that *Ficus subincisa* might be a good resource for the future development of anti-inflammatory health foods.

A research on e-commerce agri business in scope and status in india

N. Hariharan

¹Parvathy's arts and science college, Wisdom city, dindigul- 624 002 Tamil nadu, india.

ABSTRACT

In these days's agriculture and the meals deliver chain is widespread, there appears a history of brief adoption and integration of new technologies, particularly value reduction technology. Agriculture turned into recognized as one of the exceptional guarantees of e-trade because of the high level of fragmentation found in the supply chain, big

volumes traded, and homogeneous products best bolstered the expectations. Net technology has provided the possibility for cost reduction and demand enhancement along the food supply chain through the usage of e-commerce. This paper encapsulates the popularity of information generation and agriculture in india, e-business platform for indian agriculture marketplace and challenges in addition to strategies in adoption of e-trade in agribusiness sector in india. The gift observe begins with a pitching to e-trade and agriculture along with well-known framework for e-trade adoption followed with the aid of exceptional commercial enterprise models helping e-trade adoption. However e-trade is nonetheless distinctly primitive, however today an increasing number of organizations want to post on the net itself, as that is essential to stay competitive.

Effect of mulches and fertigation on yield of turmeric (*Curcuma longa* L.)

Chanchal Nikam¹, V. S. Kale² and A. P. Pawar³

^{1,2,3} *Dr. P. D. K. V., Akola -444001, India*

ABSTRACT

A field experiment was carried out at the Department of Horticulture, Dr. Panjabrao Deshmukh Krishi Vidyapeeth, Akola (M.S.) during the two years (2017-18 and 2018-19) with objective to find out suitable mulch and fertigation schedule on yield of turmeric. The treatment consists of combinations of three mulches (M1-control i.e. without mulch, M2-soybean straw mulch, and M3-silver polythene mulch) with five fertigation schedule (F1-control i.e.100 % RDF through soil application, F2-10 no. of splits with 15 days interval through fertigation @80% RDF, F3-20 no. of splits with 8 days interval through fertigation @80% RDF, F4-30 no. of splits with 5 days interval through fertigation @80% RDF, and F5-40 no. of splits with 4 days interval through fertigation @80% RDF) and was arranged in strip plot design with three replication. The result revealed that the yield parameters were significantly influenced by the different mulches and fertigation scheduling. Among the different mulches, M2 i.e. soybean straw mulch was found significantly superior in respect of number of mother rhizome and fingers plant-1, length of mother rhizome and primary fingers (cm), yield plant-1 (g), yield (q/ha), processed fingers (q/ha), dry matter plant-1 and recovery percentage (cm). Regarding the fertigation scheduling, F4 i.e. 30 no. of splits with 5 days interval through fertigation @80% RDF was found significantly superior for number of mother rhizome and fingers plant-1, length of mother rhizome and primary fingers (cm), yield plant-1 (g), yield (q/ha), processed fingers (q/ha), dry matter plant-1 and recovery percentage (%). An interaction effect of different mulches and fertigation scheduling in respect of yield parameters i.e. yield plant-1, total yield (q/ha) and processed fingers (q/ha), recovery percentage (%) was found significant with the treatment combination of M2F4 (soybean straw mulch with 30 no. of splits with 5 days interval through fertigation @80% RDF) during both the years of experimentation.

Keywords: Fertigation schedules, Mulching, Turmeric, and Yield.

Priming: Seeds retain their germination overstretch

Guntha Adhithya

¹*UAS, GKVK, Bangalore*

ABSTRACT

Seed priming is a pre-germination treatment administered through various chemical, physical and biological agents, which induce mild stress during the early phases of germination. The versatility and realistic yield gains associated with seed priming and its connection with stress memory make a critical examination useful for the design of robust approaches for maximizing seed yield. The major signalling events for regulating early seed germination, including the DOG1, ABA, ABA-GA antagonism and nucleus-organelle communication. Highlight the potential for merging findings on seed priming with those of stress memory, with the dual benefit of advancing fundamental research and boosting crop productivity. Triple mutation in the PLY1, PLY4 and PLY6 ABA receptors, OsGS3, OsGW2 and OsGn1a triple mutants resulted in an approximately 30 % increase in seed yield in rice. Taken together, transgenic technology in combination with CRISPR/Cas9-based genome editing tools is likely to accelerate the development of new crop varieties. Priming treatments activate various enzymes like hydrolases, proteases, α -amylase and dehydrogenase, which facilitate endosperm weakening and stored reserve mobilization, to improve seed vigour and hormones, signalling mediators, transcription factors, defence genes/proteins during the early stages of seed germination. In addition, stress-responsive transcription factors, DNA repair proteins and metabolites like sugar, antioxidants and osmolytes are also up regulated, together contributing to the stress-tolerant phenotype of SPR-treated plants. DNA damage repair-related genes were up regulated in response to bio priming which improved seed germination and seedling establishment. Phase I is dominated by the activation of repair mechanisms to restore any dehydration-induced damage that took place during

seed maturation. Phase II, wherein water uptake remains stable and the testa (seed coat) ruptures. During imbibition, ROS accumulate inside the seed, leading to carbonylation of storage proteins like cruciferin, and reserve mobilization. Phase III involves a rapid increase in water uptake, enabling cell elongation as well as DNA replication and cell division. As an adaptive mechanism, plants retain ‘memories’ of previously encountered stress that help them to confront impending stresses more rapidly and more efficiently. Multiple mechanisms, including chromatin remodelling, alternative transcript splicing, metabolite accumulation and autophagy have been used to explain somatic memory in plants. During seed-to-seedling transition, the prevailing stress marks can be imprinted on the genome just as in stress-primed plants, leading to improved stress tolerance. Suggest that systematic screening should be performed to promote the cultivation of local varieties that respond best to seed priming, so as to maximize the cost benefit ratio for farmers. Seed priming and stress memory induce a ‘bet-hedging’ strategy in plants, they produce an overlapping phenotype, compromising plant growth under optimal conditions in lieu of better growth under stressful conditions. The molecular basis of stress memory is detailed at the level of chromatin reorganization, alternative transcript splicing, metabolite accumulation and autophagy. We argue that this could provide a framework to study similar mechanisms involved in seed priming. Integration of seed-priming and stress-memory-related research, identification of SPR-responsive varieties and development of dual/multiple benefit SPRs are proposed as a way forward for improving priming mediated agriculture.

Farmers’ Perception about Climate Change: A prerequisite for appropriate adaptation measures at farm level

Neha¹ and Mohammad Aslam Ansari²

¹College of Agriculture, GBPUA&T, Pantnagar, Uttarakhand, India

ABSTRACT

Global climate is changing and appear to be more complicated for developing countries. India has been recognized as one of the most vulnerable developing countries towards climate change risks, especially for small and marginal farmers because of their poor level of adaptive capacity. Therefore, the understanding of location-specific drivers of farmers’ perception and their adaptive behavior provides better insight to design appropriate policy measures to address the challenges of sustainable agricultural production and food safety. Perception about climate change is a complex process that constitutes a range of psychological constructs such as knowledge, beliefs, attitudes and concerns about if and how the climate is changing . Perception of farmers is shaped by individual’s characteristics, their experience, type of information they receive, and their cultural & geographical context where they live and work. In addition, decision to adopt a new technology or practice is a cognitive process; and loss aversion, and hyperbolic discounting can lead to suboptimal levels of adoption. The perception of farmers may be about weather related parameters such as increasing temperature, unpredictable or erratic rainfall, drought, precipitation, and changes in winter duration, etc. In many studies researchers found some factors such as access to information, forecasting about weather and climate changes, farming experience, income, age, education, training received, decision making ability etc. Such perception of farmers on various aspects of climate change is also crucial not only to gear towards timely preparedness but also for effective adaptation strategies (short run initiatives) and mitigation strategies (long run initiatives) to cope up with climate change. Adaptation to climate change does not only require what individuals perceive that something is changing or could change, but also they need to comprehend this perception, to be willing to take action and must try to do something about it. In addition, the perception of farmers about that the climate is changing can be seen as a pre-condition for the adoption of adaptation measures. Further, the successful implementation of public policies should be aimed towards the promotion of adaptation strategies with the active cooperation and participation of the intended beneficiaries. If their perception about the consequences or effects or immediacy of climate change is different from the policy makers, then it is likely that the implementation of such policy will fail to achieve the desired outcomes.

Keywords: Climate change, farmers’ perception, and adaptation strategies

Population genetic analyses of potato cyst nematode *Globodera rostochiensis* using microsatellite markers

Amit Ahuja^{1*}, M. R. Khan², and Vishal Singh Somvanshi²

^{1,2}ICAR-Indian Agricultural Research Institute, New Delhi-012

ABSTRACT

Potato is one of the major crops ensuring food and nutritional security in the developing nations. India produces 52.5 million tonnes of potatoes per annum (FAOSTAT 2020). However several abiotic and biotic stress factors hamper the production of potato crops. Potato cyst nematodes (PCNs) *Globodera rostochiensis* and *G. pallida* are the major pests of potatoes and are designated as quarantine pests in many countries including India. PCNs are predicted to co-evolve with their host potato in the Andean Cordillera region of South America. PCNs were introduced in Europe along with the breeding material brought for late blight resistance in the 18th century (Evans et al., 1975). From Europe, PCNs spread to the other parts of the world including India with the movement of improved commercial potato varieties. We aimed to identify the population genetics of *G. rostochiensis* using polymorphic SSR markers. The knowledge of population genetics is necessary to understand the establishment, evolution and spread of different population within a species under the natural environment and to devise suitable management practices. PCN samples collected from different locations of Himachal Pradesh, Uttarakhand and Jammu and Kashmir were genotyped using 7 (Gr96, Gr91, Gr90, Gr85, Gr75, Gr67, Gr50) pairs of microsatellite markers. Population genetics analyses of PCNs *G. rostochiensis* was done using STRUCTURE 2.3.4. The Genotypic data of specific microsatellite markers of worldwide populations of PCNs were retrieved from previously published studies (Boucher et al., 2013, Blacket et al., 2019). Analysis of molecular variance within Indian populations along with global populations of *G. rostochiensis* was conducted in GenAIEx 6.51b2. We found that all the Indian subpopulations of *G. rostochiensis* were similar to each other and did not contain any genetic variation. Significant molecular variance was observed when Indian subpopulations were compared to the worldwide populations which exhibited 54 %, 38 % and 8 % molecular variance among subpopulations, among individuals, and within individuals, respectively. Based on the analysis of data in structure 2.3.4 (2012) software, delta K vs. L(K) analysis has revealed the presence of two major *G. rostochiensis* populations worldwide with limited differentiations (K=2, highest peak). These two major populations were further divided into many subpopulations (K=10, highest L(K) point) belonging to different geographical regions. Our study demonstrates that *G. rostochiensis* subpopulations of Himachal Pradesh, Uttarakhand, and Jammu & Kashmir are genetically similar. However, when Indian subpopulations are compared with known worldwide populations of *G. rostochiensis*, genetic differences become apparent. A single introduction of *G. rostochiensis* has been predicted in India, followed by a local spread with the transportation of infested seed tuber. The Indian population of *G. rostochiensis* exhibits high similarity with the populations belonging to Bolivia, France, Scotland and Portugal. Similarities of Indian PCNs populations with Bolivian PCNs populations and other European PCNs populations, strengthen the evidence that PCNs spread from South America (Bolivia) to Europe (France, Scotland and Portugal) and from Europe to India.

Key words: Potato cyst nematodes; *Globodera rostochiensis*; SSR markers; Evolution; Spread

Effects of nanofertilizers on wheat

¹Department of Agronomy, School of Agriculture Lovely Professional University, Phagwara, Punjab – 144411, India

ABSTRACT

Nanotechnology is an interdisciplinary promising research field, opening countless open doors in fields like medication, pharmaceuticals, hardware, and agriculture. The usage of nanofertilizers in agriculture is the reason to diminish mineral losses in fertilizing and raises the yield during mineral administration just as well as supporting agriculture development. Therefore, this paper summarizes the effect of nanofertilizers into the plant system and effect of nanofertilizers on crop growth, yield, quality, nutrient use efficiency.

Keywords: Nanofertilizers, nanotechnology, nutrient use efficiency, agriculture

Influence of Silty Clay Loam Soil and Sand conditions on Agricultural Disc abrasive wear

Annu Rani*, T. P. Singh, Jayant Singh

¹Department of Farm Machinery and Power Engineering G.B. Pant University of Agriculture and Technology, Pantnagar

ABSTRACT

The maximum wear was found at 6-8 percent moisture range in both sand and silty-clay-loam and the wear was found to increase with increase in moisture content for sand and decrease with increase in moisture content for silt clay loam. Along the radius, the maximum decrease in thickness was found at the edge of the discs and minimum at point H which is 12.5 cm away from the edge of the disc. The wear loss was found to increase with increase in speed of operation. The M4 (42.1 HRC) make of disc found better in circular soil bin due to minimum wear. It was observed that in field conditions the cumulative wear (in terms of weight loss) was 1.79, 1.75, 1.85 and 3.49 times more than the laboratory conditions for discs M1, M2, M3 and M4, respectively. In terms of radius reduction, the wear was 1.89, 1.72, 1.61 and

3rd International Conference on “Global Initiative in Agricultural, Forestry and Applied Sciences for Food Security, Environmental Safety and Sustainable Development (GIAFAS-2021)”

1.79 times more whereas in terms of thickness reduction, the wear was 2.26, 2.19, 2.24 and 2.27 times more at grid point A to 0.585, 0.535, 0.488 and 0.429 times more at grid point H in the field test than the laboratory test for discs M1, M2, M3 and M4, respectively. This increase in wear may be due to the wide range of abrasives available in the actual field condition and more compactness.

Bacteria-derived luminescent carbon quantum dots for antibacterial activity

Megha Pant, Veena Pande and Anirban Dandapat*

¹Department of Biotechnology, Kumaun University, Bhimtal Campus, Bhimtal-263136, Uttarakhand, India

ABSTRACT

Recently, carbon quantum dots (CQDs) with a particle size range of less than 10 nm have been emerged as a new class of fluorescence carbon nanomaterials. These materials can also be functionalized with biomolecules so these can be used as effective carriers for drug delivery, bio-imaging, and also their size and other features make them promising materials to be used in sensors and electrochemical luminescence. Recent advancements show that these fluorescent carbon nanomaterials exhibit great potential for sensing and killing microorganisms. Herein, we report a one pot hydrothermal synthesis of carbon quantum dots from bacteria optimizing different temperature, time and material for functionalization. The obtained carbon dots were further characterized by transmission electron microscopy (TEM), X-ray photoelectron spectroscopy (XPS), Fourier transform infrared spectrophotometry (FTIR) and Photoluminescence spectra (PL). In addition to the synthesis these nanomaterials are used to check their bactericidal activities against both gram-negative bacteria like *Salmonella typhi* and gram positive bacteria like *Bacillus subtilis* strain. As compared to the broadly used antibiotics developed CQDs (carbon quantum dots) have advantages over them including lower cytotoxicity, excellent photo-stability and high selectivity. Due to the simple method of synthesis, low cost and eco friendliness these unique materials would certainly be used further in future for different biological applications.

Synthesis and characterization of novel heterocyclic 2-Aminopyrimidine Schiff bases as fungitoxic agents.

Amanpreet Kaur*^a, Sunita Sharma^b, ^aDiksha Verma, ^aTanvi Sahni and ^aSukhmanpreet Kaur

¹Department of Chemistry, Punjab Agricultural University, Ludhiana-141004, Punjab.

²Department of Plant Breeding and Genetics, Punjab Agricultural University, Ludhiana-141004, Punjab.

ABSTRACT

2-Aminopyrimidine is a derivatizing agent which can be used as a fluorescent label for oligosaccharide detection, in chromatographic separation, fluorometric and mass spectrometric analysis. 2-Aminopyrimidine and its derivatives are good candidates for antimicrobial, antifungal and anticorrosion activity. In the present study, a series of substituted *N*-benzylidene-2-aminopyrimidine compounds were synthesized by condensation reaction of 2-aminopyrimidine with substituted benzaldehydes (*o*-chloro, *m*-hydroxybenzaldehyde, *p*-hydroxybenzaldehyde, 2,5-dimethoxybenzaldehyde, *p*-dimethylaminobenzaldehyde, syringaldehyde, *o*-phthaldehyde, isovanillin benzaldehyde, veratraldehyde and thiophene-2-carboxyaldehyde). The obtained Schiff bases were characterized using UV, IR, ¹H NMR and ¹³C spectral studies. The antifungal activity of all the synthesized Schiff bases was screened against *Fusarium verticillioides*, *Macrophomina phaseolina*, and *Rhizoctonia solani* using poisoned food technique. The compound with *p*-dimethyl aminobenzaldehyde showed maximum inhibition and least inhibition was shown by syringaldehyde with respect to carbendazim at 50 WP as control against the three fungus. Thus, in future, this kind of pyrimidine derivatives may be used to generate better fungicides with improved fungicidal activities.

Utilization of shrimp shell meal derived natural astaxanthin with its synthetic variant enhanced antioxidative status and immune responses in *Symphysodon aequifasciatus* (Pellegrin, 1904)

Ramjanul Haque*, Paramita Banerjee Sawant, Parimal Sardar, Tincy Varghese, K.A Martin Xavier, and Narinder Kumar Chadha

¹ICAR-Central Institute of Fisheries Education, Mumbai-400061, India

ABSTRACT

3rd International Conference on “Global Initiative in Agricultural, Forestry and Applied Sciences for Food Security, Environmental Safety and Sustainable Development (GIAFAS-2021)”

An experiment was conducted to observe the efficacy of shrimp shell meal (SSM) derived natural and synthetic astaxanthin in different dietary combinations on anti-oxidative status and immune responses of *Symphysodon aequifasciatus*. Four isonitrogenous (50 % crude protein), isolipidic (9% ether extract), and isocaloric (around 400 kcal digestible energy/100 g) experimental diets viz. Control (only synthetic astaxanthin, without SSM), T₁ (15 % SSM + synthetic astaxanthin), T₂ (20 % SSM + synthetic astaxanthin), T₃ (25 % SSM + synthetic astaxanthin) were prepared and fed to satiation level twice daily for 90 days. At the end of the experiment, results indicated significantly ($p < 0.05$) lower SOD, CAT, serum glucose in T₂ and T₃ groups compared to control. The combined effect of natural and synthetic astaxanthin significantly ($p < 0.05$) enhanced the total serum protein, serum albumin & globulin, serum A:G ratio, TEC, TLC, and Hb with the most pronounced effects in the T₃ group than the control. Therefore, this present study reported for the first time that synthetic astaxanthin and shrimp shell-derived natural astaxanthin combinations at levels of 71.5 and 28.5 mg/kg, respectively (*i.e.*, T₃), can be effectively supplemented in ornamental fish diets for improving their immune responses and health status in captive condition.

Keywords: Shrimp shell waste, Fish, Astaxanthin, Antioxidant, Immunity, and Health

An account of tribe chaetostrichini (chalcidoidea: trichogrammatidae) egg parasitoids from jammu & kashmir (India).

Yawar Manzoor Bhat* & ²Mohd. Yousuf

¹Forest Entomology Discipline, Forest Protection Division Forest Research Institute, 248006, Dehradun, Uttarakhand, India.

²Department of Zoology, Central University of Kashmir, 191201, Nuner, Ganderbal, Jammu & Kashmir, India

ABSTRACT

Trichogrammatidae (Hymenoptera: Chalcidoidea) is an important and least-studied family in Chalcidoidea, mainly due to their small size, ranging in size from 0.2-1.5mm and easily characterized by having 3-segmented tarsi. The family Trichogrammatidae constitutes of economically and ecologically important group of insect egg parasitoids of various forest and agriculture insect pests mostly belonging to the orders Lepidoptera, Hemiptera, and a few of Coleoptera, Diptera and Thysanoptera. Trichogrammatids are universally accepted egg parasitoids for biological control of large number of Lepidopterous insect pests of agricultural and horticultural crops as well as insect pests of valuable forestry tree species. Species of Genus Trichogramma have achieved very high position in applied biological control of insect pests, as several species of Trichogramma are being multiplied in laboratories and these are being released in fields for biological control of insect pests. The family Trichogrammatidae is represented by 96 genera and more than 1000 species distributed throughout the world, out of which 31 genera and 175 species are known from India, and just 6 species belonging to 2 genera have been recorded from Jammu & Kashmir prior to the current study. During the present survey, several trichogrammatids have been collected from Forestry and Agro forestry areas of Jammu & Kashmir (India). Screening of species of a diverse tribe Chaetostrichini was carried out for the first time from Jammu & Kashmir. The tribe Chaetostrichini includes 27 new world genera and is represented by 13 genera in India. Eight species belonging to seven separate genera Brachygrammatella indica, Aphelinoidea almoraensis, Ufensjaipurensis, Chaetogrammahisarensis, Chaetostricha terebrata, Tumidiclava tenkaniensis, Lathromeroidea longiciliata have been recorded for the first time from Jammu & Kashmir. These trichogrammatids can be utilized in biological control of various forest and agriculture insect pests, after testing their laboratory efficacy and standardization of their mass multiplication techniques.

Key words: Biological control, Egg Parasitoids, Hymenoptera, Jammu & Kashmir, Trichogrammatidae.

Cultural Significance of Medicinally Important Wild Edible Fruits in North Kashmir with Reference to District Bandipora

Gousiya Majeed. Dr. Rayees Afzal Mir, Dr. Syed Aasif Andrabi Hussain. Dr. Mohd. Gulfishan

¹School of agricultural science, Glocal University, Saharanpur 247121 Uttar Pradesh, India

ABSTRACT

A number of wild edible fruits, used by rural and tribal populations and contributing significantly to their livelihood. Fruit is a ripened ovary, it may be either nut or fleshy and these may be cultivated and as well as from wild categories. Wild edible fruits are universally distributed and mostly present in the part of the earth where there is no human activity the use of wild edible fruit species for food and medicine has been known for a long time. North Kashmir is one of these which is acceptable for wild edible fruiting plants because of their hard geography and climatic conditions and

3rd International Conference on “Global Initiative in Agricultural, Forestry and Applied Sciences for Food Security, Environmental Safety and Sustainable Development (GIAFAS-2021)”

good taste of fruits which will attract other people as a rich source of their nutrition Wild edible fruits are very important for the well being of rural population in the region, not only for the source of supplement of food nutritional, balanced diet, medicines, and cultural purpose but also for their income. The Aim of this paper it to throw light on cultural significance of medicinally wild edible fruits of Bandipora district of north Kashmir.

Keywords ; Cultural Significance; medicinally Important Wild Edible Fruits.

Low-cost polyhouse technology for quality production at lower cost

Anand Nagsen Warghat* ShyamkantMunje, H.H. Dikey and R.S. Wankhade

¹Department of Agricultural Entomology, Sam Higginbottom University of Agriculture, Technology and Sciences, Prayagraj, Uttar Pradesh, India 211007

²Department of Agricultural Entomology, Regional Research Centre (Soybean), Amravati (M.S.) India. Dr. Panjabrao Deshmukh Krishi Vidyapeeth, Krishi nagar, Akola (M.S.)

ABSTARCT

The off-season and onset of monsoon polyhouse production was found gainful under lower-coste of <=50-meter square area. Similarly, cultivation of high value off-season olericulture under low cost protected structures was originate a feasible method for growing olericulture successfully during winter or off season with temporary protection. The yield from protected structures was off-season or onset of monsoon and hence fetched complex prices in the market. Under lower cost protected structure of 50 m² (10x5) with 7ft height a total of Rs. 11300/- would be required as an initiate cost after the practice of cultivation in both on/off seasons. Therefore, to enhance income and to ensure nutritional security of the small and marginal farmers, On/off-season nursery as well as Olericulture cultivation and also cultivation of ornamental crops like jerbera and rose under low-cost poly houses is found to be economical and profitable enterprise

True morels, *Morchella* from Jammu and Kashmir-Biodiversity, Nutritional and Phytochemical composition, Health benefits, Sustainable conservation and Marketing: A Review

Eyram Hamid and Mehnaz Aijaz

Department of Botany, Glocal University, Saharanpur-247121 (U.P.)

ABSTRACT

Morels (*Morchella* spp.) belong to the kingdom Myceteae's class Ascomycetes, division Amastigomycota. Their fruiting bodies are fragile to brittle, cup to saucer shaped, sessile, or stipitate, and are primarily brown, yellow, cream, grey, and black in colour. They can be found in a range of settings. *Morchella esculenta*, *M. conica*, *M. deliciosa*, *M. angusticipes*, *M. crassipes*, *M. vulgaris*, *M. rotunda*, *M. hybrida* (*M. semilibera*), and *M. gigaspora* are among the 10 species that have been identified in India. Six species of this genus have been identified in Jammu and Kashmir. They are highly esteemed edible mushrooms that have been used for ages in traditional cuisine. Morels (commonly known as 'Guchchi') are a prime edible fungus harvested from the wild in Jammu and Kashmir, and their strong demand makes them a significant non-timber forest produce (NTFP). Every year, dried morels are shipped from India to worldwide markets, with Jammu and Kashmir ranking second after Himachal Pradesh in the morel trade, and Uttar Pradesh as the third largest producer of morels in India. Despite the enormous demand for morels and their growing economic relevance, cultivation is limited, and they are either wild gathered or cultured for use as a functional food. Polysaccharides, as active molecules, and numerous phytochemicals, primarily phenolic compounds, tocopherols, ascorbic acid, and vitamin D, were credited with Morel's health advantages. The nutritional profile of Morel was revealed, which included sugar, amino acids, fatty and organic acids, and minerals. As a result, considerable efforts should be made to domesticate and use this unique fungus's neglected therapeutic potential on a wide scale.

Key words: Morchella, Morel, Jammu and Kashmir, Health, Nutritional composition, Phytochemicals.

Afforestation and Development of Wasteland through Agroforestry

Kushmita Dhan, Firoz Ahmad, B.C Oraon

¹Faculty of Forestry, Birsa Agricultural University, Ranchi, Jharkhand (India)

ABSTRACT

Tree growth is reported to exert an ameliorative effect on wastelands by improving their physical, chemical and biological properties. Several tree species and tree planting techniques for agroforestry have been described, which can

3rd International Conference on “Global Initiative in Agricultural, Forestry and Applied Sciences for Food Security, Environmental Safety and Sustainable Development (GIAFAS-2021)”

go a long way in greening barren undulating areas. The paper examines the possibilities of afforestation as an alternative for development of wasteland. The paper describes the use of agroforestry as a holistic approach to waste land management, and the steps in the application of agroforestry principles to waste lands. Appropriate techniques are identified as energy farms (fuel plantations and shelterbelts), silvopastoral systems, agrosilvopastoral systems with plantation crops, fish culture in dammed sites, and the use of multipurpose trees. Agroforestry has potential to contribute to restoration and conservation alongside productivity of land has been expressed in many ways, emphasizing soil conservation, land degradation, food security, land use for integrated natural resources management or biodiversity conservation and also has played a significant role in the rehabilitation of wastelands, desert and lands degraded by salinisation, water and wind erosion. Wise management of agroforestry puts forward a suitable substitute to control deteriorated asserts to increase yield and to protect environment. Providing vegetative cover to such lands with woody and herbaceous species can put these lands to optimal use and also increase the forest cover of the country. Yield potential of these degraded lands is quite low and these lands are best suited for silvopastoral and other tree-based system.

Key words: Afforestation, Agroforestry, Forest, Wasteland, Salinisation.

Study of hymenopteran insect pollinators in district Baramulla of Jammu and Kashmir Shafkat Jabbar, Dr. Mohd Majid Jamali, Dr. Rayees Afzal Mir, Dr. Syed Aasif Hussain Andrabi.

¹Glocal University, Saharanpur 247121 Uttar Pradesh, India

ABSTRACT

The present study was carried out in Baramulla district of North Kashmir during blooming season 2018/2019 to investigate the comparative pollination potential of various hymenopteran insects. For this purpose some crops on the basis of their agricultural/ horticultural importance were selected. A total of 12 species of insects belonging to order Hymenoptera comprising of 06 families i.e. Apidae (*Apis Ceranaindica*, *Apis mellifera*, *Apis dorsata*, *Bombus haemorrhoidalis*, *Bombus sp.*), Vespidae (*Vespa velutina*, *Vespa affinis*, *Polister sp.*); Formicidae (*Camponotus sp.*, *Holocomyrmex sp.*); Halictidae (*Halictus sp.*); Xylocopidae (*Xylocopa sp.*) and Ceratinidae (*Caratina hieroglyphica*) are recorded. The most prevalent insect visitors were the members of family Apidae followed by Vaspide. The result showed that among the selected crops, almost 80% were found to be mainly pollinated by honey bees i.e. honey bees constitute their major pollinators.

A review on organic weed management in Okra

¹Sidra Qidwai,¹A. K. Singh,²Niyaj Ahamad

¹Dept. of PMB&GE A.N.D. University of Agriculture & Technology

ABSTRACT

Okra (*Abelmoschus esculentus* L) belongs to the family Malvaceae and an economically vital vegetable crop grown in tropical and sub-tropical parts of the world. Okra contains high fibre, vitamin A, C, and K and minerals such as Calcium, Iron, Magnesium and Potassium. Okra is an important vegetable crop grown throughout India in summer and rainy seasons. Being a widely spaced crop, a major constraint in the successful cultivation is the heavy infestation of weeds. Reduction in the yield of okra due to weed competition has been reported to range from 59 per cent to 90 per cent. Weed community composition in conventional okra cropping system is *Avena fatua*, *Amaranthus spinosus*, *Chenopodium album*, *Convolvulus arvensis*, *Cynodon dactylon*, *Cyperus rotundus*, *Digeria arvensis*, *Echinochloa colona*, *Parthenium hysterophorus*, *Sorghum halepense*, *Portulaca oleracea*, *Eleusine indica* and *Nicanthaphysaloides* in main crop. Okra dry matter was affected by *Alternanthera tenella*, *Arachis pintoi*, *Bidens pilosa*, *Commelinabenghalensis*, *Cyperus rotundus*, *Ipomoea nil* and, especially, *Eleusine indica* which reduced the number okra leaves. The predominant species among the weed community are *Euphorbia heterophylla*, *Talinum triangulare*, *Eleusine indica*, *Cynodon dactylon*, *Commelinabenghalensis*, *Cyperus iria* and *Cyperus difformis*. The weed management by organic methods includes mulching with black polythene sheet give a weed control efficiency of 95.21% followed by mulching with paper (94.21%) and with mango leaves (90.77%), soil solarisation, Black polythene mulching give higher fruit yield of 14.58 Mg/ha, followed by paddy straw mulching and newspaper mulching (11.16 and 11.01 Mg/ha) Application of pendimethalin 500 EC was applied pre-emergence at the rate of 2.5 kg a.i./ha. immediately after sowing.

Keywords: Okra, Organic weed management, Weeds, Mulching, Black polythene.

Forest cover change and its environmental impact in kupwara region of jammu and kashmir through remote sensing.

Sajjad Ahmad khan

¹Department of Ecological botany, Glocal University Saharanpur.

ABSTRACT

The forest cover area has been changed tremendously over past 50 years across the world. Global environment changes are directly or indirectly associated with forest cover change. The objective of this study was to analyze quantitatively the forest cover change in Kupwara district through remote sensing and geographic information system (GIS) associated with field investigation in the years of 2003 to 2019. Data was extracted from different digital maps and various satellite images, also field observations were operated differently to attain correct information, which was statistically analyzed by ArcGIS software, Socioeconomic impacts such as climate change, loss of water resources, loss of forest resources, loss of wildlife habitat, draught conditions, soil erosion and air pollution were used in explaining the occurrence of changes in forest cover during the study. The result shows that the forest cover declined by 173.83km² (i.e. the annual rate of forest cover change was 10.22km²) during 2003 to 2019. The main cause founded was forest land encouragement by local people. This study concludes to preserve the forest resources by growing trees on the bare lands, degraded lands, and area prone to soil erosion on large scale in a sustainable manner.

Key words: Forest cover change; forest degradation; environmental impacts; remote sensing.

Field evaluation of novel botanical based formulation against *Meloidogyne incognita* infesting turmeric cultivation as intercrop under Coconut cropping system

Rashid Pervez¹, Rajkumar², Leela N.K.³, Santhosh J. Eapen³ and Surekha R.²

¹ICAR- Indian Agricultural Research Institute, New Delhi -110012, India

²ICAR – Central Plantation Crops Research Institute, Kasaragod-671124, Kerala, India

³ICAR- Indian Institute of Spice Research, Kozhikode-673012, Kerala, India

ABSTRACT

Plant nematodes are soil inhibiting and lethal parasites of roots of many agricultural and horticultural crops in India also in world. There has been constant increase in the plant nematode infestation in coconut cropping system when intercrop with vegetables, tuber crop, spices, turmeric and an average about 40-60% crop loss reported especially in coastal sandy soils. Turmeric is one of the most common intercrop grown in interspaces of coconut in India to generate additional income to farmer through inter cropping system. Root knot nematode, *Meloidogyne incognita* is a major problem, which causes galls and causes considerable unavoidable yield losses. Nematicides are widely used for control of this nematode pest all around the world. Due to alarming health concerns and repetitive application requirements problems, a possible alternative strategy as part of INM is the need of the day. Hence, present field experiments conducted on management of root knot nematode, *Meloidogyne incognita* infecting turmeric (cv IISR Prathibha) using botanical based formulation, marigold and carbosulfan 25 EC (standard check) under coconut cropping system during 2016, 2017 and 2018 at ICAR-CPCRI Experimental Farm, Kasaragod. Botanical based formulation was applied at @ 50 ml mixing in 2 lit. water/bed at the time of planting pre-monsoon (June) and post-monsoon (October), marigold @ 30 plant/bed compared with untreated and standard check carbosulfan 25 EC (0.1%) @ 5 lit/bed at the time of planting pre-monsoon (June) and post-monsoon (October) against root knot nematode. The study results demonstrated sustained suppression of *M. incognita* populations in soil as well as reduction in gall index (0.5 and 1) in treated plants of turmeric compared with control (gall index 5). Thus the field tested botanicals based formulations found promising against *M. incognita* and improvement in the turmeric plants health and rhizome yield.

Keywords: Botanicals, Plant nematode, Root knot nematode, Management, Turmeric, Coconut

Zero Budget Natural Farming of vegetable crops in India

Omkar Aralikatti^{1*}, Vinay Verma¹, Aman Deep Ranga¹, Divya Arti¹ and Shraddha Pundeer¹

¹Dr YS Parmar University of Horticulture and Forestry Nauni, Solan, Himachal Pradesh, India.

ABSTRACT

The green revolution has led the country to self sufficient and also enabled the farmers to harvest more crop from the same limited area. Vegetables are important constituents of Indian diet as they are a rich source of carbohydrates, proteins, vitamins, minerals, glucosinolates, antioxidants and fibre. The indiscriminate use of chemical inputs in agriculture fear/ concerns the contamination of food with agrochemicals and also the pollution of the environment, has

made us to think about alternate forms of agriculture to produce food free from toxins. The recent surge in the organic production systems reinvented the immediate need for improvement of soil health. At the same time, most organic farmers are struggling due to rising input costs and limited market. To restore the health of ecosystem new innovations are required to be implemented for the cost effective organic production of horticultural crops. India is projected to become the most populous country in the world with a population of nearly 1.7 billion by 2050. In order to feed this population, the country has to adopt a policy of vertical growth in productivity as the opportunities of further horizontal expansion of cultivated area are almost exhausted. While the country is in the process of planning to revamp its agricultural production system including R&D to meet the emerging challenges, the economic survey of 2018-19 made fervent appeal for adoption of ‘Zero Budget Natural Farming’ (ZBNF) in a big way to double farmers’ income. The farmers may be able to earn enough to double their income and be free from the debt. Also, at the country level, we will may become self reliant to meet the food and nutritional demand of the growing population and hence will be not failing in our task of meeting the Sustainable Development Goals (SDGs) of Zero Hunger and Poverty Elimination by 2030.

Selenium nanoparticles stimulate growth and defence response in *Anabaena variabilis* under paraquat stress

Haleema Naaz, Nida Jamil Khan & Tasneem Fatma*

ABSTRACT

Cyanobacterial Biotechnology Lab, Department of Biosciences, Jamia Millia Islamia, New Delhi-110025

Increasing population has resulted in increased food demand. Pesticides like paraquat have been used indiscriminately to enhance the crop growth and yield. However, this has adversely affected a wide spectrum of non-target organism like cyanobacteria that are used as a bio-fertilizer in the rice field. In the present study, biogenic-*Gleocaspagelatinosa* NCCU -430 mediated selenium nanoparticles (SeNPs) were synthesized and used as paraquat toxicity mitigator in cyanobacterial biofertilizer (*Anabaena variabilis* NCCU-442). Therefore, a comparative study was performed among control, PQ, SeNPs and SeNPs to check the efficacy of SeNPs in mitigation of PQ induced toxicity. Supplementation of SeNPs in PQ treated culture enhanced antioxidant enzymes activity i.e., SOD (7.55 %), CAT (57.94 %), APX (17.45 %) and GR (14.72 %). The findings of the present study suggested the role of SeNPs in ameliorating paraquat induced stress that may be used in sustainable rice cultivation needed for filling the gap between requirement and supply.

Keywords: Selenium nanoparticles, Cyanobacteria, Paraquat, Toxicity, Oxidative stress, Anti-oxidant system.

Effect of different growth regulators on stem cuttings of Poplar (*Populus deltoides*)

¹Satyen Chhetri , ¹Dharmveer

¹Himgiri Zee University, Dehradun, Uttarakhand, India

ABSTRACT

The present investigation entitled was conducted at experimental area of the Department of Forestry & Fisheries, Himgiri zee university, Dehradun during the year 2019 and 2020. It was hypothesized in the study that different growth regulators affect the growth traits of poplar viz: sprouting length, number of leaves, number of roots per cutting, fresh weight of shoot, fresh weight of root, dry weight of shoot, dry weight of root, and shoot diameter (cm) Under the experiment poplar plant were treated in different growth regulators solutions like; IBA, NAA, GA₃ at 200, 300 and 400 ppm of concentration and their morphological and biomass traits are studied for 6 months (30, 60, 90, 120, 150, 180 days respectively). The present data concluded that the growth regulators influence every aspect of *Populus deltoides* with the maximum and minimum effects. The stem cuttings are treated with GA₃ (300ppm) showed highest reaction compared to the NAA and IBA. GA₃ treated cuttings exhibited superior plant (rooting) performance in terms of both quality and quantity. Benefit: cost ratio is calculated by dividing the total returns obtained with the total cost involved during the cultivation. The lowest benefit: cost ratio (0.59) is obtained with application of GA₃ 400ppm due to its higher rate @ Rs. 18/unit. The maximum benefit: cost ratio (1.85) was obtained by (T₄), with the treatment of NAA 200ppm. So treatment of GA₃ may provide more benefit if the farmer will tend to sell the wood of poplar at its harvesting age, as GA₃ provided the maximum biomass and also improved other growth traits of *Populus deltoides*. Application of NAA could only be better for short duration of crop as compare to other treatments.

Synthesis of azomethines and β -lactams of aza heterocycles and antifungal evaluation against *Rhizoctonia solani*

Diksha Verma^{*a}, Sunita Sharma^b, Tanvi Sahni^a, Amanpreet Kaur^a and Sukhmanpreet Kaur^a

¹Department of Chemistry, Punjab Agricultural University, Ludhiana-141004, India

²Department of Plant Breeding and Genetics, Punjab Agricultural University, Ludhiana-141004, India

ABSTRACT

Pathogenic attack of fungi on agricultural crops is one of the most serious challenges faced by agriculturists. As the demand of food is increasing, attack of fungal pathogens on crops is also intensifying that has been deteriorating the crop yield and quality. To control this, various fungicides are used among which carbendazim and mancozeb plays significant role due to the presence of active nuclei, nitrogen, which may disrupt the cell wall synthesis via hydrogen bond formation with cell membrane active sites. Due to this, almost 60% drugs contain nitrogen heterocycle as a part of the ring. In light of importance of nitrogen containing moieties, present work was done to structurally modify the aza heterocycles to yield azomethines and β -lactams by carrying out reaction of 4-amino-1,2,4-triazole and 4-amino antipyrine with veratraldehyde and iso vanillin to yield azomethine derivatives followed by cyclization of (CH=N) moiety using chloroacetyl chloride and triethylamine to get four membered β -lactam ring. The synthesized compounds were screened for their antifungal potential against maize pathogenic strain *Rhizoctonia solani* using carbendazim as standard. It was observed that azomethine derivative of 4-amino-1,2,4-triazole and veratraldehyde was most effective among all the compounds with ED₅₀ 11.02 which is at par with standard carbendazim with ED₅₀ 10.00. None of the compounds showed ED₅₀ less than that of standard. The synthesized compounds were also found to be significantly different among themselves at all the concentrations.

Methods of breaking hardseededness in mungbean

Adhithya, G. and Siddaraju, R.

¹Department of Seed Science and Technology College of Agriculture, UAS, GKVK, Bangalore-65

ABSTRACT

The current study was carried out using various hard seed breaking methods in mungbean to evaluate the three popular varieties of green gram viz., KKM-3, WGG-42 and TRCRM-147. Seeds which were collected from field were studied to get the hard seeds for experimental purpose using different methods viz., hot water for 2 and 3 minutes, Conc. Sulphuric acid for 1 & 2 minutes, Conc. Nitric acid for 1 & 2 minutes, Sand paper scarification for 2 & 4 minutes as mechanical scarification, treatment with liquid nitrogen 5, 10 & 20 minutes and freezing treatments at -18^oC for 24h and experiment was laid out with FCRD with three replications. Significant difference was observed in three varieties and thirteen treatments on all the seed quality parameters. Interaction studies were also significantly differed. Germination was significantly differed among three varieties, the variety WGG-42 showed the highest germination (79.31 %) followed by KKM-3 (75.64 %) and lowest was in TRCRM-147 (72.82 %). Results revealed that, among three varieties, WGG-42 having significantly less number of hard seeds (16.15 %) compared to KKM-3 (18.46 %) and TRCRM-147 (19.92 %). Among the treatments, the seeds treated with Conc. Sulphuric acid (H₂SO₄) for 2 min break the hard seededness and performs better results in seed quality parameters like germination (96.0 %), root length (11.71 cm), shoot length (26.35 cm), mean seedling length (38.06 cm), mean seedling dry weight (21.58 mg), seedling vigor index I (3652) and seedling vigor index II (207) compared to untreated control in seed quality parameters (32.44 %, 9.94 cm, 16.31 cm, 26.25 cm, 19.58 mg, 841 and 64, respectively). Seed surface morphology reveals that hard and impermeable testa is the main barrier for imbibitions and consequently retards germination. Similar hard seed-coated dormancy is common in other legume also. Since seed coat rupturing implies water absorption, these results indicated that, regardless of other factors such as fungal contamination, the most suitable techniques to break down hardseededness. This could be due to seed coat properties like water impermeable palisade cell structure and composition which in turn are influenced by genotype as well as environment during production. From this study, we concluded WGG-42 reported less hard seed percentage and Conc. H₂SO₄ is the better method to break the hard seeds in green gram.

Impact of imidazolinones on weeds in pigeon pea (*Cajanus cajan* L.)

AMIT KUMAR^{1*}, A.K. DHAKA², SATISH KUMAR³, AND RAJESH KATHWAL⁴

^{1,2,3&4}Department of Agronomy, CCS Haryana Agricultural University, Hisar

ABSTRACT

Among various biotic factors limiting pigeon pea yield, weeds are of prime importance which can causes seed yield losses up to 80%. Therefore current study aims to evaluate the impact of imidazolinones on weeds in pigeon pea. Among

3rd International Conference on “Global Initiative in Agricultural, Forestry and Applied Sciences for Food Security, Environmental Safety and Sustainable Development (GIAFAS-2021)”

different weed species, *Cynodon dactylon* was not controlled by any of the herbicide treatment and *Digera arvensis* and *Cyperus rotundus* was not controlled by PRE application of pendimethalin @ 1000 g/ha. Whereas, PRE application of pendimethalin + imazethapyr @ 1000 + 75 g/ha provided best control of total weeds leads to lowest nutrient uptake by weeds. Therefore, it can be an effective and a profitable alternative to the existing recommendation (two hoeing at 25 and 45 DAS) of weed control in pigeon pea in Haryana locality.

Key Words: Imidazolinones, nutrient uptake, pendimethalin + imazethapyr, pigeon pea, weeds

Essential Oils Effectively Manages, Anthracnose of Chilli caused by *Colletotrichum capsici* during storage

Anand Milan* Sobita Simon, Abhilasha A. Lal and R K Prajapati**

¹Department of Plant Pathology Sam Higginbottom University of Agriculture, Technology and Sciences, Prayagraj (U.P.)

ABSTRACT

Chilli is an important spice and a fruit vegetable, which is widely cultivated in the world and used in human food due to the presence of phyto-chemical compounds, such as ascorbic acid (vitamin-C), carotenoids (pro-vitamin-A), tocopherols (vitamin-E), flavonoids, and capsaicinoids that are very important in preventing chronic diseases such as cancer, asthma, coughs, sore throats, toothache, diabetes and cardiovascular diseases. Therefore, the present study was conducted at Department of Plant Pathology, Sam Higginbottom University of Agriculture, Technology and Sciences, Prayagraj, Uttar Pradesh. In poisoned food technique the results showed that the maximum inhibition in colony radial growth (mm) and per cent inhibition at (0.5 %) were found in T₂ (eucalyptus oil) and T₃ (garlic oil). The maximum inhibition in colony radial growth (mm) and per cent inhibition at (0.75 %) were observed in T₂ (eucalyptus oil) and T₃ (garlic oil). In fruit bioassay process the minimum per cent disease intensity and the maximum per cent reduction over control at (0.5 %) were found in T₂ (eucalyptus oil) and T₃ (garlic oil). The minimum per cent disease intensity and the maximum per cent reduction over control at (0.75 %) were found in T₂ (eucalyptus oil) and T₃ (garlic oil). In the overall study, eucalyptus and garlic oils were found potent enough for the management of anthracnose of chilli caused by (*Colletotrichum capsici*) during storage.

Keywords: Biocontrol, chilli, essential oil, anthracnose, post harvest disease, storage

Effect of nutrients and growth regulator on growth and yield parameters of ber (*Ziziphus mauritiana* Lamk.) cv. Apple ber

Sumit, Satpal Baloda*, Jeet Ram Sharma, S.K. Sehrawat, Sushil Sharma, Arvind Malik and Sakshi

¹Department of Horticulture, CCS Haryana Agricultural University, Haryana, India, 125004

ABSTRACT

The present study was carried out at the Experimental Orchard of Department of Horticulture, CCS Haryana Agricultural University, Hisar during the year 2020-21, with the objective to study the effect of foliar application of nutrients and growth regulator on ber cv. Apple ber. Thirty-nine uniformly growing trees of ber cv. Apple ber were selected and foliar application of different concentrations of urea, zinc sulphate, potassium sulphate and gibberellic acid was done in the first and last week of October. Significant improvement in growth parameters like plant height (4.50 m), plant spread north – south (5.01m), East – West (5.07m), leaf area (31.69 cm²) was recorded with zinc sulphate @ 0.75%. While maximum increase in yield parameters like Fruit length (4.68 cm), breadth (3.54 cm), weight (44.3g), no. of fruits per tree (751), pulp weight (41.57g) and total yield per tree (33.26 kg/ tree) was recorded with zinc sulphate @ 0.75%.

Keywords: ber, foliar application, gibberellic acid, potassium sulphate, urea, zinc sulphate

Assessment of Wheat yield Under Climate Change in the Indian States

PANKAJ DAH IYA¹, ABHILASH¹, KAPIL MALIK² and EKTA PATHA K MISHRA³

¹Department of Agricultural Meteorology, CCSHAU, Hisar, Haryana

²Department of Agronomy, CCSHAU, Hisar, Haryana

³Department of Environmental Sciences and NRM, SHUATS, Prayagraj

ABSTRACT

Grid data (0.5x0.5 degree resolution) of climatic parameters (temperature and precipitation from Climatic Research Unit, CRU, University of East Anglia) and crop data (from India agri stat) were analysed for twenty-three Indian

3rd International Conference on “Global Initiative in Agricultural, Forestry and Applied Sciences for Food Security, Environmental Safety and Sustainable Development (GIAFAS-2021)”

subcontinent states from 1950 to 2015. A key finding was that temperature and precipitation, when combined, significantly explained wheat yield variability in three states: Rajasthan (39%), Uttar Pradesh (29%), and Madhya Pradesh (22%). Together, these three states account for roughly half of India's wheat production. We discovered that climate explained more than 20% of crop yield variability in a significant number of states. Precipitation alone explained wheat yield variability in 30% of India's total area, according to our analysis. However, these states account for half of regional wheat production, which is a significant proportion. Temperature-induced effects were positive for wheat yields in colder states such as Nagaland, Meghalaya, and Jammu and Kashmir, but negative in states that are relatively warmer. Temperature rise is associated with a decrease in wheat yield in five major wheat producing states (UP, MP, Rajasthan, Odisha and Andhra Pradesh). We believe that our study is new in terms of finding and emphasising the critical importance of climate change, and we recommend that it be used in the future for more robust and realistic determinations of climate vs. crop production dynamics.

Keywords: Wheat yield, temperature, precipitation, multiple regression, SPSS, ARIMA, forecast

Need of conservational strategies of medicinal plants in Kashmir Himalayas.

Bilques Aashiq, Dr. Rayees Afzal Mir, Dr. Mohd. Gulfishan, Dr. Syed Aasif Andrabi Hussain.

¹ *Glocal University, Saharanpur 247121 Uttar Pradesh, India*

ABSTRACT

The present study entitled “need of conservational strategies of medicinal plants” conducted in the year 2019-2021 of the Kashmir Himalayas. World Health Organization has listed over 21000 plant species used around the world for medicinal purpose. In India, about 2500 plant species are being used in native system of medicine. The red data book lists 427 Indian Medicinal plant entries on endangered species, of which 28 are considered extinct, 124 endangered, 81 rare and 34 insufficiently known. The devoted medicinal plants are used by various tribal's and local people to cure different affliction ranging from simple injuries, wounds, cuts, fever, diarrhea, ulcers, swelling, bone fractures, potency, antidote, skin care, night blindness, toothache, asthma, cough & cold. Medicinal plants occupy a essential precinct of health care system in India and represent a major national resource. Hence, there is a massive need for conservation of diversity of medicinal plant wealth for the present and fore coming generations, by adapting the suitable strategy with most pertinent method of conservation.

Bringing colours to food: Bell pepper

Divya Arti

¹ *Dr YS Parmar University of Horticulture and Forestry, Nauni, Solan, Himachal Pradesh, India 173 230*

ABSTRACT

Coloured Capsicum (sweet pepper or bell pepper) is the most popular salad vegetable grown in the country and it is a high-value vegetable crop. Two types of capsicum are grown commercially, first type is green capsicum cultivated in open condition mainly used as a vegetable and in fast food preparations. Second type is coloured capsicum grown under protected cultivation (poly houses/net houses) and is in high demand in star hotels, urban markets and foreign countries as a salad and in fast food preparations. So, it ensures the lucrative revenue return. The total area under capsicum in the country was 33 thousand ha during the year 2019-20 with total production of 514 thousand MT. The top five states Karnataka, Himachal Pradesh, Haryana, Jharkhand and Madhya Pradesh accounts for about 45 % of the area and 73% of production under capsicum. Karnataka is the leading state with production of about 65270 MT with 20.04 % share. Out of the total production of capsicum, about 20% is coloured capsicum with main production units being in Karnataka, Himachal Pradesh, Haryana and Jharkhand. Some of the most popular commercial hybrids in India include Indra, Yamuna (Green); Bombay, Triple star, Natasha, Inspiration, Passarella (Red); Sunnycz, Swarna, Orabelle, Bachata (Yellow). Peppers in food processing are used as food colourant, as source of pungency in food, as source of flavour, as source of pain relief for pharmaceutical use and as repellent. In many cases two or more of these properties are included in the same product; for example, paprika may be a source of colour, pungency, and flavor. People whose diets are largely colourless starches, such as rice or maize, use peppers to add colour to their bland, achromatic diets.

Keywords: Coloured, Bell pepper, Food colourant

Effect of organic, integrated and inorganic nutrient sources on plant height, tiller numbers leaf area index and total chlorophyll content of Pant Basmati I (*Oryza sativa*)

Sheela Rautela * and Gurdeep Bains**

¹Department of Plant Physiology, College of Basic Sciences and Humanities, G. B. Pant University of Agriculture and Technology, Pantnagar,(263145) Uttarakhand, India

ABSTRACT

Rice (*Oryza sativa*) play significant role in sustaining millions of life around the world. It is a major staple food crop in India. Rice is basically classified as aromatic and non-aromatic rice based on their aroma. Aromatic rice is commonly known as basmati rice and India is the largest producer as well as exporter of basmati rice across the world. As India became a leading exporter, though, the indiscriminate use of chemical fertilizer, pesticides, and water during the Green Revolution resulted in serious health and environmental issues. These uses have led to a loss of soil fertility and biological activities, increased soil salinity, and lower water tables. Concern for deteriorating environmental health, the growing demand from consumers and importers for safe and high-quality products, and opportunities for premium returns have motivated farmers to look to sustainable agriculture, also known as organic farming. However, organic fertilizers were essential for rice, increases fertilizer use–efficiency whereas, inorganic fertilizers are fast acting. All of the above directly and indirectly these fertilizers alter the physiology of crop plants. Keeping in view, the different treatments of organic I(100%), organic II(50% organic + innovative tool i.e. beejamrut ghanjeevamrut, jeevamrut); inorganic I (RDF), inorganic II(RDF + FYM@ 5 tonne per hectare) and integrated fertilizer I (50% organic + 50% inorganic) and integrated fertilizer II(25%organic + 25% inorganic + 50% innovative tool) were given to Pant Basmati I to evaluate their efficiency. Results showed that there is maximum increase in leaf area index, total chlorophyll content, carotenoid content and chlorophyll fluorescence in 100% organic treated plot in comparison to the integrated and inorganic treated plot respectively.

Key Words: Rice, Fertilizers, Innovative Tools, Ghanjeevamrut, Jeevamrut, Beejamrut, RDF(Recommended Dose of fertilizer), Plant Height, Tiller Numbers, Leaf Area Index, Total Chlorophyll Content,

Influence of salicylic acid application on growth characteristics and herbage yield of vegetatively propagated *Bacopa monnieri* (L.)

Shamiya Jahan* and Sonia Tamta**

¹Department of Plant Physiology, College of Basic Sciences and Humanities, G. B. Pant University of Agriculture and Technology, Pantnagar,(263145) Uttarakhand, India

ABSTRACT

Bacopa monnieri is important medicinal herb and commonly know as Brahmi. Bacosides (dammarane-type triterpenoid saponins) is main active chemical constituent in brahmi, which influences the memory enhancing effect due to highly commercial value in herbal industries. However, the lack of high bacoside cultivars has limited pharmaceutical utilization and production. Salicylic acid (SA), naturally occurring phenolic compound in many plants, is considered to be a potent plant hormone because of its diverse regulatory roles in plant metabolism and also regulated the plant growth and development. Optimisation of suitable concentrations of plant growth regulators has been accomplished for the highest biomass production. To find out the effect of foliar application of SA with different concentration on growth parameters and overall herbage yield, a pot experiment was conducted in the year 2021 at GBPUA&T, Pantnagar. Growth parameters were analysed after 30 days of each foliar sprays i.e. first foliar spray and second foliar spray in 30 days of interval whereas the overall herbage yield was observed after 90 days from transplanting time. The obtained results indicated that growth parameters such as shoot length and shoot numbers/pot, significantly increased of 25.88% and 20.74% with conc. of SA (75 mg L⁻¹) after 30 days of first foliar spray when compared with control. While same growth parameters, significantly increased of 26.71% and 33.33% with conc. of SA (75 mg L⁻¹) after 30 days of second foliar spray when compared with control. Whereas no. of leaves per shoot significantly increased of 51.86% and 50.35% with conc. of SA (50 mg L⁻¹) after 30 days of first and second foliar spray when compared with control. There was a significant increase in fresh herbage yield per pot (18.84%) and dry herbage yield per pot (31.23%) of the plant after 90 days when SA (75 mg L⁻¹) was applied foliarly twice after 30 days of interval. Hence, it is concluded that the optimum level of SA significantly affected growth characteristics of *Bacopa* followed by improved yield of a crop.

Keywords: Herbs, salicylic acid, foliar spray, growth characteristics, Herbage yield

Production and Immobilisation of amylase from thermophilic Bacteria from manikaran hot spring water and its application in food industry

Neerja Rana¹, Majneesh¹, Devina Vaidya² and Neha Verma¹

¹Department of Basic Sciences,² Department of Food Science and Technology Dr. Y. S. Parmar University of Horticulture and Forestry, Nauni (Solan)

ABSTRACT

Amylases are one of the most industrially important enzymes contributing approximately 60 per cent of world enzyme production. The amylases have found applications in juice processing, starch processing, paper sizing, detergent additives, bread improvement, utilization of waste biomass for valuable products, treatment of waste water and other fermentation processes including malting barley and bakery industries. Bioprocess method of amylase production is more effective than other sources. Amylase can generally be extracted from plant, microorganism and fruits. Microorganisms serve as potential source of amylase production. The present study was conducted to isolate the amylase producing bacteria from hot water spring of Manikaran in Kullu district of Himachal Pradesh. The temperature and pH of hot water spring ranges between 70°C-105°C and 4.3-6.1, respectively. Subsequently, their screening and characterization was done by starch hydrolysis test. Out of 27 isolates 8 bacterial isolates viz., MW1, MW2, MW5, MW6, MW7, MW10, MW13 and MW26 exhibit amylase producing ability. Out of which one bacterial isolate i.e. MW2 was selected for maximum amylase activity. The highest amylase activity was obtained at optimum pH 9 for MW2 and pH 8 for MW6 and temperature of 45°C after 72 h of incubation period, respectively. The crude amylase was partially purified with ammonium sulphate fractionation with 68 per cent recovery and immobilized by entrapment method on different matrices viz., alginate, chitosan and agar. Amylase immobilized in alginate matrix was found best which yielded high amylase activity and immobilization yield. The immobilized amylase can be reused up to 6 cycles and remained stable up to 35 days with more than 50 per cent relative activity. The immobilized amylase from the isolate MW2 was used to increase the yield and clarification of apple and papaya juices. The immobilized enzyme treated apple and papaya juices were found best for physico-chemical and sensory characteristics as compared to the control. Thus, the immobilized microbial amylase from hot water spring of Manikaran (Kullu) of Himachal Pradesh has a potential to be explored in food industries.

Detection of Adulteration in Milk Samples from retail shop and local vendors of Jaipur, Rajasthan, India

Rizwan Khan^{1*}, Raghavendra Prasad Mishra¹ and A.Bhattacharya¹

¹Department of Veterinary Public Health and Epidemiology, Apollo College of Veterinary Medicine, ACVM, Jaipur

ABSTRACT

Milk is considered to be a complete food as it is a valuable source of good quality protein, carbohydrate, vitamins and minerals in significant amount than any other single food. Milk and its products contribute a significant part of the diet and a considerable amount of our food expenditures goes on milk and other dairy products. Milk can be spoiled easily; due to this some vendors and middle man add preservative to milk to increase its self-life, water to increase volume and thickening agent to counter the dilution. Total 85 milk samples were collected from vendors (45) and local household (40) of Jaipur city and were examined for the presence of different adulterants and preservatives by using both milk adulteration kit as well as manually. The most commonly found adulterant in tested milk samples were detergent (28%) followed by pond water (25%), skim milk powder (14%), neutralizer (10%), glucose (11%), shampoo (8%), sodium chloride (7%), sucrose (6%) and urea (3%). The adulterants in milk not only cause economic loss but also health hazards to consumers. The person engaged in milk collection, processing, packaging and distribution in the study area should also be educated about health hazard of adulterants. Hence there is an utmost need for creating awareness among consumers and local milk vendors about unethical malpractices in milk supplying chain.

Keywords: Milk, Adulteration, Quality control, Health hazard

Economic Study of Pigeon pea(Tur)

Devyanee K. Nemade¹, Sulbha M. Sarap² and N.V. Shende³

¹ Department of Agricultural Economics & Statistics, Dr. PDKV, Akola

²Shri. Shivaji College of Agricultural, Amravati Head(Agril. Econ. & Stat.), Department of Agricultural Economics & Statistics, Dr. PDKV, Akola

ABSTRACT

In the varietal front the Pulses Research Station, Dr. Panjabrao Deshmukh Krishi Vidyapeeth, Akola has made significant progress by releasing 3 excellent Pigeon pea, variety for Maharashtra. In Pigeon pea variety PKV Tara was

3rd International Conference on “Global Initiative in Agricultural, Forestry and Applied Sciences for Food Security, Environmental Safety and Sustainable Development (GIAFAS-2021)”

released in 2013. In Pigeon pea, PKV Tara variety is resistant to wilt disease and moderately resistant to sterility mozc(SMD). Seeds are generally medium bold in size with red seed colour specially. It is suitable for cultivation in Vidarbha region of Maharashtra under normal condition. It is high yielding variety. It gives 18-20 q/ha yield and crop duration is of average 176 days. PKV Tara variety is mostly adopted in states like Maharashtra, Madhya Pradesh, Karnataka, Gujarat and Chhattisgarh. The main objective of this study, to study the growth rates of area, production and productivity of selected Pigeon pea Crop. and to study the economic impact of PKV Tara & other variety of Pigeon pea. The data on costs and returns of Pigeon pea PKV Tara, and other varieties data of Pigeon pea crop for the year 2019-20 were compiled from the Pigeon pea quick estimate reports of Agricultural Price Cost and Scheme, Department of Agril. Economics and Statistics, Dr.PDKV, Akola. In addition to this primary data has been collected for the year 2019-20. The result concluded that, gross return werework out to Rs. 97870.50/- and Rs. 83623.49/-PKV Tara and other pigeon pea variety respectively, whereas Net return observed that Rs. 29446.05/- and Rs. 19376.00/- respective variety. The Benefit cost ratio at Cost ‘A’ was 2.39 and 2.11, at Cost ‘B’ was 1.58 and 1.43 and Cost ‘C’ was 1.43 and 1.30 for PKV Tara and other variety growers respectively. It was concluded from the Benefit cost ratio that the production of PKV Tara growers was more profitable at all cost than other variety of pigeon pea growers. It indicate that as use of PKV Tara seeds for cultivation, increase the yield level of pigeon pea and reduce the cost of cultivation and so that the net return and Benefit cost ratio also increase.

Key word: Wilt disease, economic study & B:C ratio

Phenology of flowering and fruiting extent in Nagpur mandarin (*Citrus reticulata* Blanco) under Central India conditions

R. K. Jhade*¹, A. D. Huchche² and S. K. Pandey

¹Jawaharlal Nehru Krishi Vishwavidyalaya, Krishi Vigyan Kendra-II, Delakhari, Tamia, Chhindwara, Madhya Pradesh, India 480 559

²ICAR-Central Citrus Research Institute, Nagpur, India-440033

³ Department of Horticulture, JNKVV, Jabalpur,MP, India-482004

ABSTRACT

The experimental data on extent of flowering and fruiting potential in Nagpur mandarin was found lacking in the literature. Therefore this study was initiated on eight years old Nagpur mandarin plants grafted on rough lemon rootstock spaced at 6m x 6m and having *Ambia* and *Mrig* cropping (five plants each) in 2015-2016 cropping seasons in a private orchard at Hetikundi village in Wardha district Maharashtra. The plant basins were spread with polythene sheets before the start of the flower initiation for daily collection of abscised reproductive structures viz. buds, flowers, fruitlets with and without pedicel. Daily abscission records were kept till the fruit size was 21 mm (January to April in *Ambia* crop and July to October in *Mrig* crop. Dates of full bloom for the Nagpur mandarin trees in *Ambia* flowering was in the month of February and in the month of July in *Mrig* flowering. The extent of flowering in *Ambia* crop (numbers of flowers per tree=43060) was more as compared to that in *Mrig* crop (numbers of flowers per tree=22993). Abscission of reproductive structures up to 21 mm of ovary size in *Ambia* crop was observed to be 98.29% (flower drop-58.18%, fruit without pedicel-20.95%, fruit with pedicel-13.67 % and buds-5.49 % and final fruit harvest 1.58%). In the *Mrig* crop an average of 22993 flower buds produced yielding 730 fruits per tree at harvest with final fruit retention of only about 3.17 %. The month of greatest fruit drop was April in *Ambia* flowering and September in *Mrig* flowering. The abscission of small fruit occurred either at the base of the ovary or at the base of the pedicel. The *ambia* cropping trees produced mature fruit of 1.58 per cent of all flower buds, in comparison with 3.17 per cent in the *mrig* cropping season.

Keywords: Flower, buds, fruitlets, pedicel, R/H, SMC, LWP, *Ambia*, *Mrig*

Characterization of amylase producing bacteria isolated from hot water spring (jeori, shimla) and role in clarification of juices and bun making

Neha Verma^{1*} and Neerja Rana¹

¹Dr. Y S Parmar university of Horticulture and Forestry,Nauni, Solan 173230, India

ABSTRACT

Amylases are a type of industrial enzyme that accounts for around a third of all enzyme output worldwide. Amylases are used in a variety of processes, including juice processing, starch processing, textile desizing, paper sizing, detergent additives, bread improvement, waste biomass utilization for valuable products, waste water treatment, and other fermentation processes, such as malting barley and bakery industries. Amylases can be derived from a variety of

3rd International Conference on “Global Initiative in Agricultural, Forestry and Applied Sciences for Food Security, Environmental Safety and Sustainable Development (GIAFAS-2021)”

sources, including plants, bacteria, and fruits. Microorganisms serve as a potential source of amylase production. The study was carried out to isolate the amylase producing bacteria from Jeori hot water spring in Rampur Bushahr, Shimla district, Himachal Pradesh, India. Subsequently, their screening and characterization was done on the basis of morphological, biochemical and molecular parameters. Out of 6 isolates best bacterial isolate J2 was identified as amylase producing belongs to *Bacillus* sp. The highest amylase activity was obtained in apple pomace as a substrate at 72 hrs of incubation at pH 9.0 and 45°C temperature. Among different carbon sources starch followed by maltose was found to be the best. Among the nitrogen sources, Yeast extract (organic source) followed by NaNO₃ for both the isolates was found best. The amylase-producing thermophilic bacterial strain *Bacillus thuringiensis* J2 was identified by 16S rRNA gene sequencing. It was deposited in the NCBI gene bank under accession number [KY990713]. An application of 0.75 per cent of amylase from J2 isolate yields 58 per cent of apple juice and 54 percent of kiwi juice. The bacterial amylases were also tested for bun production, with a maximum leavening activity of 2.60 ml/h at a concentration of 0.75 percent for J2. In addition, the quality of the buns from the chosen concentration was measured. At a 0.75 percent amylase concentration, the loaf volume and crumb grain was 179.11 cm³ and 0.171% for J2. Sensory characteristics of dough viz., color, taste, flavour and overall acceptability were also enhanced at 0.75 per cent of amylase. Hence, amylase yield, stability and the low cost substrate production supported the hypothesis that microbial enzymes have potential in food industries. These natural resources need to be exploited for commercial enzymes.

Keyword: Amylase, *Bacillus*, Gene sequencing, Thermophilic

The Role of Salicylic Acid in Plants Exposed to Heavy Metals

Fatima Shabir.

¹Department of life science (Botany)

ABSTRACT

Salicylic acid (SA) is a clear and simple phenolic compound (C₇H₆O₃ compound composed of an aromatic ring, one carboxylic and a hydroxyl group). SA is important in plant growth and development for important physiological functions such as increasing the plant's response to stress conditions (abiotic and biotic). Under stress, including HM stress, SA interacts with other plant hormones (e.g. auxins, abscisic acid, gibberellins) and promotes the activation of antioxidant compounds and enzymes, alerting HM-treated plants and assisting in HM stress resistance. Stress has a negative impact on plants, resulting in unfavorable results. This factor can be either abiotic (like climate and soil) or biotic (like weeds, pathogens, insects, and so on). Plant survival, growth, and yield are all affected by stress, as is the primary assimilation process, which includes photosynthetic rate, nutrient accumulation, and growth rate. Elastic stress occurs when the plant recovers after the stress factor is removed, whereas plastic stress occurs when the plant is deformed and the change is irreversible after the stress factor is introduced. The purpose of this study is to describe the role of SA in abiotic stress and how SA act as tolerant inducer during abiotic stress in plants.

Keywords: Stress, salicylic acid, plant, tolerant inducer, plant hormone

Fortification Additives and Nutritional Spectrum of Food

Sangeeta¹

¹Home - science (Food & Nutrition), RML Awadh University, Ayodhya, Uttar Pradesh

ABSTRACT

Food fortification is the process in which many micronutrients are added to the food, addition of micronutrients is helpful in improving the nutritional value of food and preventing deficiency diseases. Due to the food processing, milling, storage, packaging vital nutrients destroyed thus diet we take have less nutrients which are essential for our body, these micro and macro mineral and vitamins are very important in regulation of digestive system absorption of nutrient by intestine and improve gut health. Additives are substance added to food to preserve and enhance taste, appearance etc. this allows for longer lasting foods. Additives added to the food direct or indirect method which includes natural and artificial. There are evidences and finding of research shows that many times fortification leads excessive nutrient intake and additives which are chemical based harmful for the health. Some additives have been used for centuries as part of an effort to preserve food like vinegar, salt, smoke, sugar etc. Fortification and additives have pros and cons of its use, fortification is exist in many countries for vitamins and minerals, this process enhance the vital nutrients in diet. Present study conducted on 200 people by using pretested schedule with two parts of question set. Result of this study shows that 63% of respondent are agree that additives which are added to the food are harmful for the health and 37% are believe that fortification and additives enhance taste and appearance of food item .

Key Words: Fortification, additives, health impact and nutritional value.

Govt. Policies and planning for Sustainable Development of Agriculture FPO; a step forward to Succeed

Amit Dixit¹, Pappu Lal Bairwa²

^{1,2}*College of Agriculture and Research Station, Kurud Dhamtari, IGKV, Raipur, Chhattisgarh, India*

ABSTRACT

The Indian agriculture sector has made significant strides in the past few decades by meeting the required production of basic staple like rice and wheat to feed the growing population. However, farmers are unable to realize the right value for their produce and achieve full potential in terms of yield. The majority of farmers has small or marginal holdings of land and continues to live with drudgeries of agriculture, trapped in vicious poverty cycle. Department of Agriculture and Cooperation of the Ministry of Agriculture in order to streamline the consolidation of land as well as integration of smallholders into agricultural value chain, initiated farmer producer organizations. FPO is the most appropriate institutional form and mechanism to mobilize farmers and build their capacity to collectively leverage their production and marketing strengths. It is a member based farmer's institutions imperative to feed the growing population under changing climate scenario. Besides India, countries like China, Vietnam, and Indonesia etc. have also adopted the FPO approach. FPOs were formed and registered under the Companies Act 2013 with various initiatives of the GOI, State Governments, NABARD and other organizations, presently numbering around 5000 FPOs. Of these, around 3200 FPOs are registered as Producer Companies and the remaining as Cooperatives/ Societies, etc. FPO formed with a vision to build a prosperous and sustainable member-owned producer organization that enable farmers to enhance productivity through efficient, cost-effective and sustainable resource use and realize higher returns for their produce, through collective action. It is good to link agriculture universities, management institutions, agriculture department in government, and other knowledge institutions with the government. This should be seen as two way solution, knowledge institutions are keen for action research studies, to better analyze the success and failure factors, data directly from farmers can help them and policy makers in long run. While, farmers are need regular capacity building in business management, production practices and technicality of production.

Keywords: Indian agriculture, farmers, FPO, sustainable resources, management practices

Genetic improvement of *Capsicum annum* L. through induced mutagenesis.

Mohd Gulfishan^{1*}, RayeesAfzal Mir¹, Syed Aasif Hussain Andrabi¹, Ajmat Jahan²

¹*Glocal School of Agricultural Science, Glocal University, Saharanpur-247121*

ABSTRACT

One of the prerequisites for crop improvement is genetic heterogeneity. As a result, the inability to pick better genotypes is limited due to a lack of needed variety. Artificially produced mutations are the most efficient technique to increase genetic variability quickly. Because natural mutations occur seldom, artificial mutations are generated, and genetic variability is best increased by using mutagens. Through procedures such as induced mutagenesis, it is critical to regenerate or restore the genetic variability of diverse types from different parts of the world. Several scientists have reported using mutagenesis to generate genetic variability in quantitative and qualitative features, as well as to build new intended correlations between quantitative and qualitative traits. In the present investigation, EMS, a chemical mutagen, have been used to create genetic variability in *Capsicum annum* L. Dry and healthy seeds of two varieties of *Capsicum annum* L. were treated to various doses of EMS. In order to assess the mutagenic potency and create acceptable genetic variability in the crop, observations on morphological, cytological, and physiological parameters were recorded in M1 and M2 generations. Plant height, number of fertile branches, number of fruit per plant, number of seeds per fruit, and 1000 seed weight (g) were among the quantitative features that revealed substantial inter-treatment differences at various mutagenic dosages. The findings of the present study are encouraging, and show that significant genetic variability had been induced by the mutagens, thus the rigorous selection of the desirable mutants may result in the development of improved and high yielding mutants of *Capsicum annum* L. in subsequent generations.

Key words: EMS, mutation, mutagenesis, *Capsicum annum* L., genetic variability, quantitative characters.

INTEGRATED FARMING SYSTEM: A BOON FOR FARMER'S INCOME IN RURAL INDIA

Hrishikesh Nath^{1*}, Dr. Rajan Kumar², Dr. Biswajit Pramanick²

¹*Department Of Agronomy, PG College of A,*

²*Dr. Rajendra Prasad Central Agricultural University, PUSA, Samastipur - 848125, Bihar, India.*

ABSTRACT

Integrated Farming system (IFS) is a combination of many components of systems to increase farmer's income using natural resources sustainability basis which can be obtained by integrating crop husbandry with allied enterprises is called IFS. IFS approach helps upon welfare of the farmer's family and increase their earnings by developing a better livelihood. Farming in India is characterized by small, marginal and fragmented land holdings (about 86 %) and is highly depended on monsoon showers. Operating small holdings is often unviable and in this situation, farming is not a profitable business or enterprise. There is a urgent need of transformation in agriculture production combined with IFS approaches that involves crop cultivation, dairy, poultry, fishery, mushroom cultivation, agro- forestry, piggery, beekeeping, vegetable and fruit production, use of renewable energy source (i.e. Solar energy, biogas) etc. For doubling of the farmer's income few vital strategies might be need to be adopted considering the basic requirements of the farmers. These strategies might help in agricultural research through proper investments, adoption of Good Agricultural practices (GAP), judicious use of available resources and inputs, with their transportation facilities, Minimum Support Price (MSP) reform, supported by adequate and timely availability of bank credits. It has been reported that a rise in MSP will raise farmer by 13 to 26 %. Prime Minister's commitment to Doubling real income of Farmer's till 2022- 23 over the base year of 2015 – 16, requires annual growth of 10.41 percent in farmer's income. Smart Farming and credit supporting farming are other possible strategies in doubling farmer's income. When there is a thought of diversification we get to know about high value Crops. IFS make sustainable use of Farm Resources.

Keywords: Crop Husbandry, Diversification, IFS, Judicious, Sustainability

CONTRIBUTION OF GREEN TECHNOLOGIES IN SUSTAINABLE DEVELOPMENT

Ragini Kumari^{1*}, Mona Kumari², Shailja Kumari², Gopal Kumar³, Rajeev Padbhushan¹ and Rajkishore Kumar¹

Deptt. of Soil Science & Agricultural Chemistry, Bihar Agricultural University, Sabour, Bhagalpur-813210

ABSTRACT

In the present scenario, green technologies are playing a key role in shifting the nation's economic growth trajectory toward sustainability and providing an alternative socio-economic model that will allow current and future generations to live in a clean and healthy environment that is in tune with nature. Green technology, also known as clean technology, is the advancement and extension of processes, practises, and applications that improve or replace existing technologies, allowing society to meet its own needs while significantly reducing human impact on the planet, as well as reducing environmental risks and ecological scarcities. It can operate in diversified sectors such as biofuel, eco-forestry, renewable energy, waste management, bioenergy, nanotechnology, green chemistry, bioremediation, degraded land reclamation for conserving natural environment and resources. Among these, renewable energy can play an essential role in helping to meet basic energy needs by utilising modern technologies. Solar photovoltaic is used in agriculture as a green energy source for pumping water, village street lighting, rural house lighting, and pest management. Biofuels such as bioethanol and biodiesel have the potential to become a significant part of the future energy platter. Positive consequences can be seen in the conversion of wasteland to farmland with some crop alternatives. Bio gas meets the criteria since it makes use of organic agricultural waste and converts it to fuel and fertiliser. Fuel-wood, farm leftovers, livestock manure, and kerosene savings are all direct effects of bio gas. Increases in soil fertility and crop production have also been observed. Bio gas also eliminates indoor air pollution and promotes sanitation in the home or community. Hydropower plants can also help with irrigation and value addition at the point of origin for agricultural products. Combustion, gasification, and cogeneration technologies are used to transform agricultural residues and wastes into electric and heat energy. Biomass technologies complement traditional agricultural production while reducing or totally replacing traditional fuel consumption. Green measures for resource conservation and environmental protection will aid in maintaining the greater economic growth rate required to meet basic necessities while maintaining a reasonable quality of life in the future. Sustainable development, according to the Brundtland Commission (1983), is development that meets current demands without jeopardising future generations' ability to meet their own. Only increased international knowledge and large-scale adjustments in production and consumption patterns can lead to sustainable development that is respectful of social fairness and environmental health. Recognizing the debilitating and even catastrophic effects of climate change, governments all over the world should pledge to limit their carbon dioxide emissions and so lessen their contribution to the climate. Policymakers should examine not only domestic economic problems, but also the important scientific and technological challenges that all countries face in order to advance toward sustainable development.

Keywords: Green technology, Sustainability, Biofuels, Environmental health, Renewable energy and Resource conservation.

Attitude of Farmers towards Drip Irrigation: A Study in Kumaon Hills of Uttarakhand

Pooja Karki¹ and Amardeep²

College of Agriculture, GBPUA&T, Pantnagar, Uttarakhand, India

ABSTRACT

This study focused on attitude of farmers towards drip irrigation. Study was conducted in Ramgrah block of Nainital district. Four villages from Ramghar block were selected purposively. Samples of total 120 respondents were selected through PPS method. The finding of this study revealed that majority of respondents had studied upto high school education (35.83%). All the respondents were involved in agriculture (100%), had low annual income (74.17%), were small farmers (98.34%), had mixed farming (100%), and were using tank for the irrigation (50%). It further revealed that majority of the respondents had medium mass media exposure (57.50%), medium economic motivation (74.16%) and medium risk orientation (64.17%). In spite of this majority of the respondents (67.50%) had neutral attitude towards drip irrigation. Further, it was found that major constraints faced by the respondents in adopting drip irrigation were difficulties in maintenance, lack of technological knowledge about drip irrigation or training in respect use of drip irrigation, frost sensitive pipe of drip irrigation and cracks to pipeline and micro tube.

Key words: Attitude, drip irrigation, constraints

PLANT GROWTH PROMOTING RHIZOBACTERIA (PGPR): AN ECOFRIENDLY APPROACH FOR SUSTAINABLE AGRICULTURE AND ABIOTIC STRESS MANAGEMENT

Ranjna^{1*}, Neerja Rana¹ and Akanksha Rathore¹

¹Dr Y. S. Parmar University of Horticulture and Forestry, Nauni, Solan 173230, India

ABSTRACT

The climate change is the major global threats which arises due to heavy rainfall, temperature fluctuation, water scarcity and salinization of farm land. All these are the major concerning abiotic factors which strongly affect the crop productivity. Plants are severely affected by these stress factors which impairs with plant growth, development and decrease the final crop yield and the main reason of heavy cost loss for farmers whose income source are only farming. Secondly, human being and animal face famine like condition through worldwide. The abiotic challenges faced by plants are low water availability (drought), excess water (flooding/waterlogging), extremes of temperatures (chilling, cold, frost and heat), mineral deficiency, salinity and toxicity. Salinity, HMs and drought are the most common abiotic stresses which severely affects the plant growth and biomass production. Increased incidences of biotic and abiotic stresses are the main reason for deterioration of agricultural productivity of crops particularly in tropical regions due to natural and anthropogenic factors. Plants undergo a number of physiological and metabolic changes to protect them in response to abiotic stresses. To overcome this, efficient resource management can mitigate the adverse effect of biotic and abiotic stress. However, these strategies being long drawn and cost intensive, there is a need to develop simple and low cost biological methods for the management of abiotic stress, which can be used on short term basis. Microbes have been shown to be of great help to fight against abiotic stress, via their biological activities at the rhizosphere of plants. Microorganisms that inhabit in the rhizosphere, are the most effective tool which play a vital role in adaptation strategies and increased the tolerance to abiotic stresses in agricultural plants. The plant growth promoting rhizobacteria (PGPR) play an important role against the abiotic stresses in terms of enhancing the efficacy of soil, plant growth promotion (PGP). PGPRs have certain specific PGP properties such as hormones synthesis, 1-aminocyclopropane-1-carboxylate (ACC) deaminase, Indole-3-acetic acid (IAA) production, enzymes production, nitrogen fixation, and phosphorus (P) solubilization, hydrogen cyanide production as results which protect various crops during such stress conditions and consequently enhance crop sustainability. A purposeful use of PGPR in agriculture is an attractive technology to fight against various stresses factors. Thus, application of PGPR may provide a mechanism through which rhizobacteria ameliorate phytostimulatory and stress tolerance potential, simultaneously. PGPR is also used as biocontrol agents, and the ineffectiveness of PGPR in the field have often been accredited to their inability to colonize plant roots. These PGPRs are also helpful for phytoremediation by various processes such as direct absorption, accumulation, etc. PGPR strains belonging to genera *Bacillus*, *Burkholderia*, *Azotobacter*, *Erwinia*, *Azospirillum*, *Beijerinckia*, *Rhizobium*, and *Serratia* are now being used cosmopolitan to enhance the agricultural productivity. Using PGPR can help meet the expected demand for global agricultural productivity to feed the world's booming population. These PGPR must be safe for the environment, offer considerable plant growth promotion and biocontrol potential, be compatible with useful soil rhizobacteria, and be able to withstand various biotic and abiotic stresses. PGPR commercialization is also an important task for its advantageous application for agriculture sustainability and it requires a proper amendment

3rd International Conference on “Global Initiative in Agricultural, Forestry and Applied Sciences for Food Security, Environmental Safety and Sustainable Development (GIAFAS-2021)”

between industries and scientific organization. PGPRs are used in the biofertilizers preparation, being a vital module of organic farming play key role in upholding long-term soil fertility and sustainability. The above finding concluded that PGPR has the ability to manage abiotic stress and help in sustainable agriculture. PGPR is one of the revolutionary ways to enhance crop productivity as well as food quality without any environmental issue. Hence, we can say that PGPR is an eco-friendly initiative approach for enhancing agricultural productivity and soil quality by managing abiotic stresses. Keeping all the things in mind, it is necessary to explore the use of PGPR to achieve environmental sustainability and agricultural productivity in the future for different aspects related to sustainability and stress management.

BIODIVERSITY AND ETHNOBOTANICAL USE OF PLANTS OF DISTRICT UPWARA, J&K, INDIA

Laraib Ahad, Dr. Rayees Afzal, Dr. Mohd Gulfishan, Dr. Syed Aasif Andrabi Hussain

¹*Department of life science (botany)*

ABSTRACT

Biological diversity refers to the variety and variability among living organisms and the ecological complexes in which they occur. Forests are one of the most valuable ecosystems in the world, containing over 60 per cent of the world's biodiversity. This biodiversity has multiple social and economic values, apart from its intrinsic value, varying from the important ecological functions of forests in terms of soil and watershed protection to the economic value of the numerous products, which can be extracted from the forests and play a vital role in climate regulation and constitute one of the major carbon sinks on earth, preventing increase in green house effect. Ethnobotany is the study of how the people of a particular region and culture make the use of indigenous plants while the ethnobotanist explores how plants are used for food, shelter, medicine, clothing hunting and religious ceremonies. It is the relationship between a given society and its environment and in particular the plant world. Plants have played an essential role in the treatment of diseases since prehistoric times. Almost all cultures in the world have a body of knowledge on the therapeutic properties of local flora. Herbal medicine even today plays a vital role in rural areas and many locally produced drugs are still being used as household remedies for various diseases specially in these areas for different ailments like plant parts are used to cure cold, cough, piles, blood purifier, toothache, stomach disorders. It is well known that traditional medicine offers minimal side effects and relatively low cost as compared to other systems of medicine. According to WHO, 80% of the people in developing countries still depend on local medicinal plants to fulfill their primary health needs. Field surveys were conducted during the different seasons of the area to collect data from the local people, experienced persons about the knowledge and practice of using wild plant species...

Key Words : Biological diversity, Remedies, Ecosystem, Medicinal plants, ethnobotanical survey.

Monitoring of water pollution caused by aminophenols by degradation with oxone: A kinetic-spectrophotometric study

Manila & Neha Bhatt.

¹*Department of Chemistry, Gurukula Kangri (Deemed to be University), Haridwar (U.K.), India.*

ABSTRACT

The presence of toxic chemicals in water streams is one of the major concerns these days around the globe. Amongst the category of chemicals, aminophenols are known to be the one which are being used in large scale by various industries for preparation of different products. It is used as dyeing agents in furs, hair, leather industries and as intermediates in the pharmaceutical industries. Aminophenols are obviously classified as one of the chemicals with substantial impact on humans as well as environment around us owing to its widespread effects. The major effects on human being are wheezing, cough, fatigue, dizziness, headache, asthma, chest tightness, skin allergy with added impact on kidneys also. Aminophenols might show carcinogenic effects also which is of great concern. High limits of aminophenols affect ecosystem as a whole especially aquatic ecosystem. The industrial effluent laden with aminophenols can impact ground water and streams both and thus accounts for a greater outreach of its ill-effects to the ecosystem as a whole. Keeping in view all this, research on aminophenols in different areas is being undertaken to ensure a cleaner environment for generations to come. The present work focusses on development of a low-cost alternative for the monitoring of aminophenols by kinetic spectrophotometric method and thereby ensuring the adequate quality of potable water available to us.

Keywords: (Aminophenols, chemicals, asthma, carcinogenic, kinetic spectrophotometric)

Effects of different media on the *in vitro* shoot induction of *Elaeocarpus ganitrus*

Manisha Chaudhary¹, Rishi^{*}, Harinder Vishwakarma², Sandeep Kumar^{1*}

¹*School of Biological Engineering and Life Sciences, Shobhit Institute of Engineering and Technology (Deemed to be University), Modipuram NH-58, Meerut-250110 (UP, India)*

²*National Bureau of Plant Genetic Resources, Pusa Campus, New Delhi-110012, India*

ABSTRACT

The present study deals with the effects of growth media on *in vitro* micropropagation of *Elaeocarpus ganitrus* (Roxb.). Different media were used MS (Murashige and Skoog medium, 1962), Anderson medium, WPM (Woody Plant Medium) Lloyd and McCown 1981) and B5 Gamborg medium. Plant growth regulators (PGR) were taken at different concentration range individually and in mixture in all the three media. Initiations of shoots were observed on MS medium when supplemented with specific concentration of phytohormone. All the media were fortified with antioxidants.

Nutritional Aspects of *Moringa oleifera* Lam.

Mohit Kundal

¹*Department of Tree Improvement and Genetic Resources, College of Forestry Dr. Yashwant Singh Parmar University of Horticulture and Forestry, Nauni, Solan, Himachal Pradesh 173 230*

ABSTRACT

Drumstick *Moringa oleifera* Lam. is most widely distributed and naturalized species of the monogeneric family Moringaceae. The genus *Moringa* has more than 13 species, of which *M. oleifera* Lam is originated in India. Commonly known as the drumstick tree, horse radish tree or West Indian Ben, this tree is a fast growing and medium sized tree having tripinnate leaves. It is a drought resistant species and is found widely in the sub-Himalayan tracts of northern India. Almost all parts viz., root, bark, gum, leaf, pod, flower, seed and seed oil have been used for treatment of various inflammation and infectious diseases along with cardiovascular, gastrointestinal, haematological and hepatorenal, disorders. Leaves contain 9.1% carbohydrates, 2.1% dietary fiber, 1.7% fat and 8.1% protein. Leaves are rich in protein and present an amino acid composition, which is suitable for human and animal nutrition. It is referred to as a nutrient dense food source because of its high nutritional value of leaves, pods and seeds. In general, 100 g of *Moringa* leaves contain four times more vitamin A than the same quantity of carrots, four times more calcium than 100 mL of milk, four times more iron than 100 g of spinach, seven times more vitamin C than 100 g of oranges and three times more potassium than 100 g of bananas. The protein quality of drumstick leaves also rivals that of milk and eggs.

Keywords: *Moringa oleifera*, protein, amino acid, vitamin A, Iron

Influence of Nitrogen with Different Organic Sources on Yield and Quality of Peanut (*Arachis hypogaea* L.)

Moinuddin¹, Wajid Hasan², Farooq Ahmad Khan³ and Tahir Ali⁴

¹*School of Agricultural Sciences Shri Guru Ram Rai University- Dehradun (U.K) India*

²*Krishi Vigyan Kendra, Jahanabad- Bihar and ^{3&4}SKUAST-Kashmir, Srinagar (J&K)*

ABSTRACT

Peanuts help prevent heart disease by lowering cholesterol levels. They can also stop small blood clots from forming and reduce your risk of having a heart attack or stroke. Foods with a lot of protein can help you feel full with fewer calories. Groundnut has the primary place among all the seed crops in the Republic of India accounting for quite 40% surface area and 60% production within the country. Groundnut is the single largest source of edible oils in India and constitutes roughly about 50% of the total oilseeds production. Use of organic manures to meet the nutrient requirement of the crop would be an inevitable practice for sustainable agriculture. Since organic manures generally improve the soil's physical, chemical and biological properties along with conserving the moisture holding capacity of the soil and thus resulting in enhanced crop productivity along with maintaining the quality of crop production. Organic farming in recent years is gaining significance due to the realization of inherent advantages it confers in sustaining crop production and also in maintaining dynamic soil nutrient status and safe environment. Application of different organic source of nitrogen is getting value and popularity due to its positive results in nutrient management and quality food produced and also increased yield attributes of groundnut (*Arachis hypogaea* L.). Nitrogen includes an important role in manufacturing the agricultural product and choosing the quantity of nitrogen- containing fertilizers are necessary for having the best production level. Groundnut being a leguminous crop, it is capable of fixing atmospheric nitrogen

3rd International Conference on “Global Initiative in Agricultural, Forestry and Applied Sciences for Food Security, Environmental Safety and Sustainable Development (GIAFAS-2021)”

Peanut perform better in terms of yield and quality when good cultivar was sown under optimum nutrient management coupled with organic nutrient management. Application of different organic manure may be adopted for obtaining maximum yield and quality of groundnut.

Keywords: Nitrogen, Organic manure, Peanut, yield and quality

INDIGENOUS KNOWLEDGE OF MEDICINAL PLANTS: A CASE STUDY OF GULMARG AREA OF J&K

Muzamil Mohiuddin, Dr. Rayees Afzal Mir, Dr. Mohd. Gulfishan, Dr. Syed Aasif Andrabi Hussain.

¹*Glocal University, Saharanpur 247121 Uttar Pradesh, India*

ABSTRACT

Ethnobotany is the scientific study of the relationships that exist between people and the plants. Ethnobotany aims to document the valuable knowledge of the tribal regarding the use of plants. The tribal people use the plants in their unique ways for various purposes mostly for the treatment of various diseases. There is a need to document this valuable knowledge as it is draining off at a rapid speed. An initiative was taken to document the ethnic knowledge regarding the medicinal plants in the Gulmarg and its allied areas in Kashmir Division of Jammu and Kashmir. During the survey about 80 plants, used for treatment of various diseases and ailments were documented. These plants are used for the treatment of various diseases like headache, toothache, epilepsy, gastric problems, skin disorders, pneumonia jaundice.

Utilization of *Trichoderma* spp. for growth promoting and controlling *Fusarium oxysporum* disease of *Ocimum tenuiflorum* (Linn.)

Nasreen Musheer^{1*} and Shabbir Ashraf²

¹*Department of Plant Protection, Aligarh Muslim University, Aligarh.*

ABSTRACT

Trichoderma spp. are rapid colonizers, invasive, filamentous, opportunistic, avirulent and symbionts. Tulsi-*Trichoderma* interaction is a complicated process that exhibits numerous mechanisms to promote plant growth and biocontrol *Fusarium* wilt disease. The aim of the study to evaluate the biocontrol action of four *Trichoderma* species in suppression of *Fusarium* wilts severity and improvement of plant growth. *In vitro*, *T. harzianum*, *T. viride*, *T. koningii* and *T. atroviride* were significant in inhibiting the colony growth of *Fusarium oxysporum*. Among all, *T. harzianum* had greater antagonistic activity in declining the *Fusarium oxysporum* colonization rate in soil under field condition during 2017-2019. All biocontrol agents were efficient in increasing the height, root length, number leaves of *Ocimum tenuiflorum* L. over control in both years of trial. *Trichoderma* revealed symbiont soft tulsi plants, led plant resistance to pathogen, promotes absorption of nutrient, and improves developmental processes and yields. *Trichoderma* offers varied biocontrol mechanisms such as antibiosis, competition and mycoparasitism to prevent the pathogen development and spread. Thus, the study evidenced the *Trichoderma* are potent to promote the plant growth and reduces the *Fusarium* wilt disease in an ecofriendly and sustainable manner.

Keywords: *Trichoderma*; *Fusarium*; *Ocimum tenuiflorum*; mycoparasitism; symbiosis.

Evaluation of Modified Onion Storage Structure under Northern dry zone of Karnataka

P. V. Naik, Zaheer Ahamed, , Raju Teggeli, Mahantesh Jogi, Yusufali and Shreenivas B.V

¹*ICAR KVK, Kalaburagi, UAS Raichur*

ABSTRACT

The rate of deterioration of onion in the arid dry zone environment due to inadequate storage structure cannot be overemphasized. The storage life of onion is dependent mainly on temperature and humidity. Onion is grown in the north east dry zone mostly by small and marginal farmers and transportation is the major problem to the various regions in the country. To ensure supply of the commodity all year round, adequate storage facilities must be put in place. The objective of this study is to evaluate a modified onion storage structure in terms of its potentials to reduce sprouting of bulbs, post harvest loss by modifying the temperature and relative humidity and increases the air circulation in storage structure which would help extend the shelf life of onion and reducing post-harvest losses. A storage structure capable of storing onions in a north dry zone-I and II. The environment was redesigned and constructed using locally available materials and tested for 12-weeks. The structure was constructed with 0.8 m height of base × 4.50 m width and 4 m height × 30 mm GI soft without exhaust fan, naturally ventilated and was covered with asbestos roofing sheets and

3rd International Conference on “Global Initiative in Agricultural, Forestry and Applied Sciences for Food Security, Environmental Safety and Sustainable Development (GIAFAS-2021)”

chicken mesh. The storage structure is 10 m × 4 m × 5 m for length, breadth and height respectively with exhaust fan 1400 RPM with perforated 12mm PUC pipes and is divided into three compartments (Based on size of bulb divided in to A, B and C). and another heap method with exhaust fan 1400 rpm. The parameters measured included temperature, relative humidity and weight of the onions and the results were subjected to appropriate statistical analysis. Temperatures within and outside the structure ranged from 24.5°C to 33.5°C in the morning period, 32.0°C to 43.2°C in the afternoon period and 30.0°C to 34.6°C in the evening period. Physical examination performed on the stored onions bulbs after twelve weeks revealed minimum deterioration, with onions stored at compartment B recording the lowest percentage of weight loss of 7.2% while compartment A had a 12.11% weight loss and compartment C recorded a 18.9% weight loss. Relative humidity within and outside the structure ranged from 54% to 66% in the morning, 51% to 75% in the afternoon and 66% to 82% in the evening. The highest relative humidity value (82%) was recorded in the morning period and the lowest (51%) was recorded in the afternoon. The test of correlation analysis performed on the results indicated large significant difference between the internal and external temperature and relative humidity readings. It is concluded that the structure has performed well by reducing ambient temperature and relative humidity thereby prolonging the shelf life and reduced the postharvest loss of the product.

Organic Production of Vegetable Crops from Farm Generated Inputs

Vinay Verma

¹Department of Vegetable Science, College of Horticulture, Dr. Yashwant Singh Parmar University of Horticulture and Forestry, Nauni, Solan, Himachal Pradesh, India 173230

ABSTRACT

The green revolution enabled the farmers to harvest more crop from the same limited area. However, indiscriminate use of chemical fertilizers has been resulted in adverse effects on the environment and polluting the soil and ground water resources. Recent soil nutrients survey (any reference) indicates that, most of the Indian soils are deficient in both macro and micro nutrients. The recent surge in the organic production systems reinvented the immediate need for improvement of soil health. India is home to 30 per cent of the total organic producers in the world, but accounts for just 2.59 per cent (1.5 million hectares) of the total organic cultivation area of 57.8 million hectares (World of Organic Agriculture 2018 report). At the same time, most organic farmers are struggling due to rising input costs and limited market. Use of organic liquid preparations has been an age old practice in India. On farm produced *Kunapajala*, prepared by fermenting animal flesh along with herbal products used to be an established technique in ancient India. As an alternative, number of organic farmers devised organic boosters based on local experiences and gave specific names such as *Amritpani*, *Panchagavya*, *Beejamrita*, *Jiwamrita* etc. Similarly, in other organic farming systems, few effective preparations such as BD-500, BD-501, Cow Pat Pit, Biodynamic liquid manures and in Homa Organic Farming: Agnihotra ash enriched water and Biosol are effective materials being used by number of organizations. To restore the health of ecosystem new innovations are required to be implemented for the cost effective organic production of horticultural crops. The essential concept of these practices is “back to nature, where the philosophy is to feed the soil rather than the crops to maintain soil health and it is a means of giving back to the nature what has been taken from it”.

Keywords: Agnihotra, Beejamrita, Bisol, Kunapajala.

Assessing the relationship of Human Ecological Variables on Linguistic Intelligence of Elementary Boys

Priyanka*, Sudha Chhikara and Diksha

¹Department of Human Development and Family Studies I.C. College of Home Science, CCSHAU, Hisar, Haryana-125004, India

ABSTRACT

Multiple Intelligence (MI) helps to evaluate the brain processes of individuals. Identifying the types of multiple intelligence can help teachers to understand their students better. Giving our students the chance to discover and develop their different intelligences can have a series of benefits for our students; from fostering new talents to becoming more involved and active learners; developing their capacity to recognize, and almost more importantly value their individual strengths; or guiding them into becoming confident, successful and accomplished adults in their field of choice. Gardner identified a minimum of nine "intelligences," problem-solving and product-producing capabilities: Verbal-linguistic, Logical-mathematical, Visual-spatial, Bodily-kinaesthetic, Musical-rhythmic, Intrapersonal, Interpersonal, Environmental-naturalist and Existentialist. Ecological Systems Theory bestowed by Urie Bronfenbrenner (1979) describes that there are five systems arranged from the closest to the individual to the farthest and these systems directly or indirectly affects the human development. The present study was designed to study the level of linguistic intelligence

3rd International Conference on “Global Initiative in Agricultural, Forestry and Applied Sciences for Food Security, Environmental Safety and Sustainable Development (GIAFAS-2021)”

and impact of various human ecological factors affecting it. To achieve this aim, standardized Multiple Intelligence Assessment Tool developed by Dabas, 2000 was administered on a study sample consisting of 200 students from elementary schools of both areas of Fatehabad (Haryana) i.e., rural and urban. Results revealed that cultural settings of the respondents were significantly associated with linguistic intelligence. Further it was observed that family education, income residential surroundings relationship and interaction with neighbours as well as exposure to mass media had significant association with linguistic intelligence of the elementary boys whereas other factors did not show any significant association with the linguistic intelligence.

Keywords: Linguistic Intelligence, Human ecological factors, Elementary boys, Fatehabad (Haryana).

SPEED BREEDING: A PROMISING TOOL TO CROP BREEDING

Aman Deep Ranga

¹*Department of Vegetable Science, College of Horticulture, Dr. Yashwant Singh Parmar University of Horticulture and Forestry, Nauni, Solan, Himachal Pradesh, India 173230*

ABSTRACT

Speed breeding, a crop breeding technique originally developed by NASA in the 80's to help grow crops in space, can hasten the process of developing new crop varieties. In layman terms speed breeding can be defined as “a specific or a set of techniques that are able enough to speed up or quicken the cultivation of crops”. The technique uses artificial light and temperature conditions to speed up the crossing and inbreeding of varieties. This can help plant breeders to grow six generations of various crops viz., spring wheat, chickpea and barley and four generations of canola plants in specially modified glasshouses. The speed breeding system is used normally for accelerating the development of plants that have better genetics and then they are transplanted to the fields. In fields, they need to be tested for yield, disease resistance, quality, etc. It can be used to rapidly generate fixed populations through single seed descent method which in some species may be cheaper than generation of double haploids for subsequent field evaluations facilitating genetic gain and production of improved cultivars. Current improvement rate of some crops is inadequate to meet global food security and future demand and this is majorly contributed by the slow improvement rate or long generation time of crops.

Keywords: Double haploids, Genetics, Glasshouses, NASA

Fabrication of Syringic Schiff bases and β -lactams along with their antimicrobial evaluation

Tanvi Sahni^a, Sunita Sharma^b, Diksha Verma^a, SukhmannpreetKaur^a and AmanpreetKaur^a

¹*Department of Chemistry, Punjab Agricultural University, Ludhiana-141001, India*

²*Department of Plant Breeding and Genetics, Punjab Agricultural University, Ludhiana-141001, India*

ABSTRACT

β -Lactams and Schiff bases are one of promising moieties in synthetic chemistry and commonly known as antibiotic cephalosporin and penicillin. Syringaldehyde, one of naturally occurring phenolic aldehyde present as major proportion in agricultural wastes (corn stem, wheat straw) is one of promising compound considered for research in synthetic chemistry. Hence, Unification of Syringaldehyde with nine aromatic amines (aniline, 2-aminopyridine, 3-aminopyridine, 4-aminopyridine, o-phenylenediamine, 2-amino-4-phenylthiazole, ampicillin and benzylamine) was conducted in this study which led to synthesis of benzylidene derivatives. Cyclization of benzylidene derivatives of syringaldehyde with (4-amino antipyrone and 4-aminophenol) using chloroacetyl chloride in presence of triethylamine led to synthesis of syringic β -Lactams. Evaluation of these schiff bases and β -Lactams as antimicrobial agent was done against *Bacillus subtilis* and *Enterobacter* sp.; *Rhizoctonia solani* and *Dreschlera maydis* along with their respective standards ampicillin and Carbendazim 50 WP and found to be as promising against *R. solani* and *B. subtilis*.

Transgenics in vegetable crops

Ankush Chaudhary

¹*Department of Vegetable Science, College of Horticulture, Dr. Y.S. Parmar University of Horticulture and Forestry, Nauni, Solan, Himachal Pradesh – 173230*

ABSTRACT

Transgenic crops, commonly referred to as genetically modified (GM) crops, enable breeders to bring favourable genes, often inaccessible by conventional methods, into elite cultivars, improving their value considerably and offering unique opportunities for controlling insects and other pathogens. Many vegetable crops have been genetically modified to include resistance to insects, other pathogens (including viruses), and herbicides and for improved features, such as slow

ripening, higher nutritional status, seedless fruit and increased sweetness. Vegetables account for a significant share of the global pesticide market. About 20% of the world’s annual pesticides expenditures (amounting to US\$ 8.1 billion) are spent for growing vegetables. Despite pesticide use, insects, pathogens, and weeds continue to cause a heavy toll on world vegetable production. Pre harvest losses are globally estimated as 15% for insect pests, 13% for damage by pathogens, and about 12% for weeds. The genetically modified crops represent a promising technology that can make a vital contribution to global food, feed and fiber security. The first genetically modified food approved for release was the FlavrSavr tomato in 1994 developed by Calgene, it was engineered to have a longer shelf life by inserting an antisense gene that delayed ripening. Antisense suppression of one of the tomato TBG4 resulted in producing fruits that at red-ripe stage were 40% firmer than the wild type control. NewLeaf®, NewLeafY®, and NewLeafPlus® were the trade names of the transgenic potato cultivars sold by NatureMark®, a subsidiary of Monsanto®. The New Leaf potato, a GM food developed using naturally occurring bacteria found in the soil known as *Bacillus thuringiensis*(Bt), was made to provide in-plant protection from the yield-robbing Colorado potato beetle. Transgenic cucumber lines derived from ‘Poinsett 76’ expressing the CMV coat protein gene for host plant resistance to CMV.

Keywords:Cytomegalovirus, β -galactosidase genes

Impact of climate change on incidence of major soybean and black gram diseases under Bundelkhand Agro-climatic zone

U.S. Dhakad, R.K. Prajapati, B.S. Kirar, I.D. Singh and Jai Pal Chhigarh

¹*Krishi Vigyan Kendra, Tikamgarh (M.P.) 472001*

ABSTRACT

Krishi Vigyan Kendra, Tikamgarh (M.P.) was conducted studies on field demonstrations trails in the farmers’ field during Kharif season of 2020 and 2021 for assessment of suitable soybean and black gram resistant varieties against MYMV, YMV, cercospora and anthracnose diseases which were already prevalent in these crops of Kharif dominated crops of the district. Beside, climatic change has been observed year-by-year which has been play an important role in rate of diseases incidence and occurrence on the same crop diseases. Tikamgarh district belongs to Bundelkhand Agro-climatic zone of Madhya Pradesh, which is a rainfed area and due to extremely vulnerability in annual rainfall, topography, cropping system and traditional farming. All these realities were evidently showing that Bundelkhand is still facing the grave tragedy of drought. The soil like light, medium is the sharing 75% part which are not suitable for high value cropping as well as farming system due to low water and nutrients holding nature. The farmers (75%) were come under marginal and small class, which were not having agriculture implements and did traditional cultivation. The field demonstrations carried out with major varieties in soybean –JS 335 and in black gram T-9 for the MYMV, YMV, Cercospora and anthracnose as control with other varieties as treatment *i.e.* soybean (RVSM 2011-35, Rajsoya-18, Rajsoya-24, JS 20-116, JS 2098, JS2969 and JS 2034) while in black gram (IPU02-43, IPU1026, IPU94-1, IPU11-02 and IPU 13-01) with three replications of each variety among 25-farmers of three villages. The RDF of fertilizers and manures and other recommended practices of cultivation were carried out. Each demonstration was conducted in one-acre area with 30 x10 cm distance for maintaining the plant population. The total rainfall of both the year were found variable and commencement of monsoon which affected the sowing, germination and insect-pest population other hand from the diseases. The pool data of both the year result showed that among soybean varieties the YMV incidence was recorded 11.2-41.3 %. Minimum incidence of YMV was recorded in RVSM 2011-35 and maximum in Rajsoya-18 while Rajsoya-24, JS20-116 and JS2069 were found resistant against the YMV but none of the varieties were found infected with anthracnose and cercospora. Among the black gram varieties only IPU 1026 was recorded for 11.4% incidence of MYMV while all other black gram varieties were found resistant. But the incidence of anthracnose was recorded 11.2-34.2% among the all varieties of black gram. Besides, the anthracnose, 11.2-15.6% except in IPU 94-1 and IPU 1026. The demonstrations were aimed to enhance the resilience of Indian agriculture to climate change and climate vulnerability through strategic research and technology demonstration. The farmers were not practicing to grown resistant varieties while sowing of the local or unidentified varieties seeds of soybean and black gram crops. The present studies might be helpful in planning of various farmers’ welfare programme to save the economic losses due to diseases incidence and making the reduction in cost of cultivations.

Keywords:MYMV, Cercospora, Anthracnose, Black gram, Soybean, Incidence, Diseases

Interactive effect of *Meloidogyne incognita* and fly ash on the growth, physiology, and antioxidant properties of carrot (*Daucus carota* L.)

Adnan Shakeel*, Abrar Ahmad Khan

¹*Section of Environmental Botany and Plant Pathology, Faculty of Life Sciences, Aligarh Muslim University, Aligarh 202002, India*

ABSTRACT

Alternative methods are needed to replace chemical nematicides because they have the potential to damage beneficial soil microbial diversity. Therefore, the present work was done to elucidate the soil ameliorative, plant-growth-promoting and nematicidal properties of fly ash. A random block designed pot experiment was conducted during the period, December 2018–February 2019. Seeds of carrot (*Daucus carota* L.) were sown under natural conditions in clay pots containing growth medium comprising of field soil amended with different levels of fly ash. Plants were inoculated with *Meloidogyne incognita* that were molecularly characterized using 18S and D2/D3 fragment of 28S rDNA and morphologically through perineal pattern arrangement. The results revealed that fly ash application improved soil's important physicochemical characteristics. The inoculation of *M. incognita* significantly reduced the plant growth, yield and pigment content of carrot compared to the untreated uninoculated plants. Carrot grown in 15% fly ash (85:15 w/w field soil: fly ash) growth substrate had significantly ($P \leq 0.05$) improved plant growth, yield, and pigment content as compared to the untreated inoculated plants. Moreover, the proline content and the activity of superoxide dismutase (SOD) and catalase (CAT) were enhanced by applying 15% fly ash. Fly ash amendment to the soil not only improved plant growth and yield but also reduced the gall index and egg mass index per root system of the carrot as well. Our results, therefore, suggest that 15% fly ash can be used in a sustainable way to improve the growth, yield, and resistance of carrot against the infection of *M. incognita*.

Keywords: Environment pollution; Crops; Root-knot nematode; Soil amendment; *Daucus carota*

A study of customer relationship management practices of J&K

Zakir Hussain Khandy

¹*Department of Commerce, Global University Saharanpur*

ABSTRACT

Customer Relationship Management (CRM) is an established concept which is used to manage customer lifecycle through various technologies and process oriented tools. This study identifies how social media can be utilized in the CRM context for improved customer relationship management and to understand the potential of social CRM in the business environment. Recent changes in customer relationship theme and putting new media and network - based paradigm into practice makes it imperative to find how social networks affect CRM. The industry is witnessing a communication revolution that is traversing from social media to social CRM. This new paradigm – Social CRM – recognizes that instead of just managing customers, the role of the business is to facilitate collaborative social experiences and dialogue that customers value. Given the strategic relevance of CRM for organizations nowadays, the main objective of this study is to explain the role of social networks in customer relationship management by using its analysis, tools and aspects based on CRM models. We have provided a CRM framework that is based on the traditional CRM models and incorporates social networks and its tools, methods and analysis

Keywords ; customer relationship; CRM.

Significance of Organic Manures on the Growth and Yield of Indian Spinach (*Beta vulgaris* var *bengalensis*) under Low-Hills of Uttarakhand

Alice Kaintura^{1*}, Dr Suneeta Singh² and Dr Anil Kumar Saxena³

¹*Department of Soil Science, School of Agricultural Sciences, SGRR University, Dehradun- 248 001, Uttarakhand, INDIA*

²*Department of Horticulture, School of Agricultural Sciences, SGRR University, Dehradun- 248 001, Uttarakhand, INDIA*

³*Department of Soil Science, School of Agricultural Sciences, SGRR University, Dehradun- 248 001, Uttarakhand, INDIA*

ABSTRACT

A field experiment was planned and conducted during 2020-21 at Horticulture Research Block, School of Agriculture Sciences, SGRRU, Dehradun, Uttarakhand. To investigate the “Significance of Organic Manures on the Growth and

3rd International Conference on “Global Initiative in Agricultural, Forestry and Applied Sciences for Food Security, Environmental Safety and Sustainable Development (GIAFAS-2021)”

Yield of Indian Spinach (*Beta vulgaris* var *bengalensis*) at Low Hills of Uttarakhand”. The experiment was laid out in randomized block design with three replications and nine treatments including various organic manures at different concentrations. Observations on various growth and yield attributes were recorded at regular intervals. Studies on vegetative and yield attributes were recorded using standard method of measurements. Of all the organic treatments of soil application with Farmyard Manure (5kg) + Vermicompost (2.5kg) + foliar spray of Vermiwash (25%) was sown the significant improvement in plant height (cm), Number of leaves/plants, Length of leaves (cm), Width of leaves (cm), Petiole length (cm), Root length (cm) and yield than other treatments.

Keywords: Spinach, organic manures, FYM, vermicompost, vermiwash

Production, optimization and characterization of siderophore produced by fluorescent pseudomonads and its application in growth suppression of pathogen (Plant and Human) and enhancement of Mustard plant

Apoorva Dixit¹, Chhaya Verma¹, Rajesh Kumar¹,

¹*Department of Environmental Microbiology Babasaheb Bhimrao Ambedkar University (A Central University) VidyaVihar Raebareli Road, Lucknow, India*

ABSTRACT

In this study production of siderophore was analysed in three fluorescent pseudomonads named as K₁, G₁ and H₁S. Fluorescent pseudomonads have ability to excrete siderophore which is a strong iron chelating agent. Siderophore has a broad range of application, such as in agriculture (as an iron fertilizer and biocontrol agent) as well as in medical field (as an antimalarial, anticancer, iron overloaded diseases). All three isolates were selected for production, optimization and characterization of siderophore. Findings of this experiment represented that siderophore production was affected when additional supplement was provided by different nitrogen source, carbon source, pH, different concentration of NaCl, FeCl₃ and different incubation days. Further, siderophore crystals were extracted by H₁S isolate by using methanol, after mixing of sulphuric acid, ferrous sulphate and 50% ammonium sulphate at low pH. Produced crystal was purified and analysed by SEM (Scanning Electron Microscope) and FTIR (Fourier-transform infrared spectroscopy). After purification, crude was used to inhibit the growth of human pathogen *Proteus mirabilis* and Citrus fruit fungal pathogen. Extracted siderophore was also gave an appropriate result for growth enhancement of the mustard applied in growth enhancement of Mustard plant. This study reveals about the different growth parameters for maximum siderophore production and also worked on its application as a biocontrol agent as well as in growth promotion of mustard plant.

Keywords: Siderophore, Fluorescent pseudomonad, Biocontrol, *Proteus mirabilis*, Optimization.

Effect of Green synthesized iron oxide nanoparticles on growth and development of mung bean

Samia Saleem and Mohd. Saghir Khan

¹*Department of Agricultural Microbiology, Aligarh Muslim University Aligarh- 202002 Uttar Pradesh, India*

ABSTRACT

Recently Nanotechnology exerts great impact in the sector of Agriculture. Application of nanomaterials in the agriculture domain is of great importance because of their unique physicochemical properties. The interaction of nanoparticles with plants causes morphological, physiological, and genetic changes, and understanding these changes is critical for the efficient application of nanotechnology. In the present study we synthesized the iron nanoparticles using the leaf extract of *Syzygiumcumini*. The synthesized nanoparticles characterized by various techniques such as FTIR, XRD, SEM and EDX. The impact of biosynthesized nanoparticles on the mung bean applied in the concentration range of 100, 200 and 300mg/kg studied after exposure of 80 days. Iron oxide nanoparticles increases the growth and biomass significantly in addition to this photosynthetic pigments, total protein content and antioxidant enzymes also increases. These findings show that the plant growth promoting potential of nanoparticles, as well as the eco-friendly and cost-effective nature of green synthesis, pave the way for nanotechnology to be used in sustainable agriculture practices.

Key words: Nanoparticles, Iron oxide, Mung bean, *Syzygiumcumini*

Trees for Remediation

Desha Meena^{1*}, Shiwani Bhatnagar²

¹*Genetics and Tree Improvement Division, Arid Forest Research Institute, New Pali Road, Jodhpur, Rajasthan, India. Pin-342005*

²*Forest Protection Division, Arid Forest Research Institute, New Pali Road, Jodhpur, Rajasthan, India. Pin-342005*

ABSTRACT

Phytoremediation uses living plants for *in situ* remediation of contaminated soils, sediments, tailing and groundwater. These practices integrates the removal, or degradation of toxic wastes that is capable of cleaning up an area with low to moderate levels of contaminations. This technology is attracting increasing attention from scientists, remediation engineers, and environmental professionals in government, industry, and universities. In situ remediation using plants has the potential to be less expensive than current technologies and to simultaneously initiate both detoxification of hazardous waste and site restoration. The perennial habit, extensive root mass, and large transpiration rates give trees advantages over other plants for use in remediation. Trees are already used for wastewater clean-up, for site stabilization, and as barriers to subsurface flow of contaminated groundwater. In this communication, we emphasize the research progress made with respect to screening of tree species for their ability for remediation through direct and indirect approach.

Keywords: Genetic Engineering, Hazardous waste, Heavy metals, Phytoextraction, Phytoremediation

CLIMATE-RESILIENT AGRICULTURE FOR ENSURING FOOD SECURITY IN THE FACE OF CLIMATE CHANGE WITH SPECIAL REFERENCE TO ARUNACHAL PRADESH, INDIA

Dipak Sharma*, SailajanandaSaikia, Jyoti Saikia

¹*Department of Geography, Rajiv Gandhi University Rono Hills, Doimukh- 791112, Arunachal Pradesh, India*

ABSTRACT

Variability in the trends of rainfall and temperature owing to global warming and climate change is posing a great deal of concern among policymakers in both developing and developed economies across the globe. This is because numerous studies have already shown direct as well as indirect severe impacts of rainfall and temperature variability on agricultural production. As such, all economies are most likely to face the problem of lower agricultural production in the short term (present), and in the long term (future), this may create a situation of food unavailability, and thereby food insecurity. In this paper, the emerging need and importance of climate-resilient agriculture as a way to ensure food security in the light of climate change in the present and future is discussed in length with special emphasis reference to Arunachal Pradesh, one of the eight North-Eastern States of India. The need for climate-resilient agriculture in the study area (Arunachal Pradesh) is sought based on five key facts: first, agriculture, is indeed, the most vulnerable sector to climate change; second, agriculture in the state plays a prominent role not only in sustaining the livelihood of agrarian society but also providing a source of livelihood to a large section of the society. Besides, agriculture also contributes a significant share to the state's GDP. Third, the production of rice (staple food crop) in India as a whole and Arunachal Pradesh in particular to a large extent is possible because of monsoon rains (*June – September*). Fourth, the examination of the trends of rainfall and temperature over the last forty years clearly shows that the state is witnessing variability in rainfall and temperature pattern. Fifth, the state is still largely dependent on the supplies (food grains) from the central pool.

Key Words: Climate change, agriculture, Food Security, climate-resilient agriculture

A kinetic mechanistic study of hexacyanoferrate (III) oxidation of o-aminophenol to 2-aminophenozin-3-one in aqueous alkaline medium

Anjali Goel and Monika Rani*

¹*Department of Chemistry, KGC, Gurukul Kangri (Deemed to be University), Haridwar 249407, India.*

ABSTRACT

Industries gave a lot of benefits to the society with some drawbacks such as discharge of effluent with some pollutants like phenols, azo dyes, nitro compounds and carcinogens etc. These pollutants cause water, air and soil pollution depending upon the mode of discharge of waste chemicals which affect the environment. The most common method of discharge is in the surface water which is harmful for activities and aquatic life also. In the present study we are working on the common pollutant o-aminophenol discharged from many industries like textile, plastic, printing, paper industry

3rd International Conference on “Global Initiative in Agricultural, Forestry and Applied Sciences for Food Security, Environmental Safety and Sustainable Development (GIAFAS-2021)”

etc. There are many conventional methods for the removal of organic pollutants such as- adsorption, ozonation and electrochemical oxidation etc. but these methods have some limitations like transfer contaminants, short half life, sludge formation and high cost respectively. The oxidation of aqueous organic pollutant is an attractive removal method because of its high efficiency and simplicity. In the present work oxidation of o-aminophenol by hexacyanoferrate (III) ions in aqueous alkaline medium has been studied. The oxidation of o-aminophenol has been followed by kinetic spectrophotometric method. The effect of pH, ionic strength, concentration of o-aminophenol, hexacyanoferrate (III), and temperature has been analysed. The temperature variation was studied at pH 9 within the range 298-313 K and the corresponding activation energy, enthalpy, entropy, pre exponential factor and free energy are calculated. The formation of product 2-aminophenozin-3-one was confirmed by FTIR and mass spectroscopy. 2-aminophenozin-3-one has antimicrobial properties. It is also used as an antineoplastic agent. Thus, the present method seems to be of low operational cost and eco-friendly.

Food and nutrition security for gender equality

¹Dr. RenuGangwar, ²Dr. Dharendra Kumar Singh and ³Amita Yadav

^{1,2} *College of Agriculture, Kotwa, Azamgarh (ANDUAT, Ayodhya)*

³ *College of Agriculture, LPU, Jalandhar Punjab*

ABSTRACT

In India, food security is a dynamic concept that dependent on food production to self-sufficiency of food. Gender equality can make a substantial contribution to a country's economic growth, and it is the single most important determinant of food security. Gender equality can be achieved through equal participation of men and women by ensuring equal access to productive assets (land, water, credit), technologies, and services helps to ensure food security. Food security refers to the situation that exists when all people, at all times, have physical and economic access to sufficient, safe and nutritious food that meet their dietary needs and food preferences for an active and healthy life (FAO, 2006). Women faced various difficulties to access to agricultural credits, limited agricultural information, extension services and restricted mobility. Women's inclusion in microfinance initiatives occur largely through self-help groups. Apart from credit, women have access to land and they face sociocultural and institutional barriers to cultivation. Most of the extension services tend to favour to progressive farmers. However, there is negligible role of microcredit schemes to improved food production to women's empowerment. Recognizing the importance of food production through technological innovations and improving economic access to food for better nutritional outcomes, government policies provisioned for subsidized food for pregnant and lactating women and economic access to facilitate right to work guaranteed by the MGNREGA. Agricultural information and technology need to consider gender-specific needs and constraints such as good quality infrastructure, drinking water, health, and childcare.

Eco-Friendly Textiles: Fostering Sustainability and Accountability

Arpita Grover* and Nisha Arya

¹*Department of Textile and Apparel Designing, I.C. College of Home Science, Chaudhary Charan Singh Haryana Agricultural University, Hisar-125 004 (Haryana), India*

ABSTRACT

Textiles, also known as clothing, are the universal human need. Humans nowadays not only satisfy this basic need, but they are also becoming more concerned about the environment since the textile industry is one of the most polluting industries in the world. The conversion of clothing from the fibre stage to the fabric stage includes a number of processes that are environmentally harmful. The use of toxic chemicals, high consumption of water and energy, generation of a large amount of solid and gaseous wastes, massive fuel consumption for transportation to remote locations where textile units are located, and use of non-biodegradable packaging materials in these clothing processes are the issues that make the life cycles of textiles and clothing unsustainable. Environmental consciousness, pollution management, and user-friendliness are the underlying reasons for rising trends with sustainability practices. An environmentally sustainable approach is being adopted in many sectors, including textiles, in order to save the environment and to foster sustainability in the field of textiles. The goal of sustainable fashion, often known as eco fashion, is to create a system that can be sustained indefinitely in terms of human effect on the environment and social responsibility. In recent times, various technologies, techniques, and practices related to textile production have been developed to protect the world from the adverse effects of chemicals which are either used in the textile industry or released as a by-product in the environment. There are some of the eco-friendly methods, techniques, approaches, and practices that are gaining

3rd International Conference on “Global Initiative in Agricultural, Forestry and Applied Sciences for Food Security, Environmental Safety and Sustainable Development (GIAFAS-2021)”

popularity in textile and apparel industry for sustainability comprises natural fiber-based textiles, natural dye and finishes.

Keywords- Eco-friendly textiles, textile industry, environmental impact, sustainability

Antibacterial potential of synthesized silver nanoparticles using bioactive metabolites of actinobacteria against Bacterial meningitis

Naushin Bano¹, Roohi¹, Mohammad Amir¹ and Saba Siddiqui^{2*}

¹Protein research Laboratory, Department of Bioengineering, Integral University, Lucknow, India. ²Integral Institute of Agricultural Science and Technology, Integral University, Lucknow, India.

ABSTRACT

Multidrug-resistant bacteria pose a serious threat to humanity, prompting research into new weapons to battle the problem. Researchers are now focusing on secondary metabolites produced by bacteria to address these concerns. Actinobacteria are being investigated as a possible solution to this problem due to their exceptional antibacterial properties. Actinobacteria silver nanoparticles are also green, eco-friendly, and cost-effective, with antibacterial and antifungal capabilities and the potential to be used in pharmaceuticals. The present work aimed to identify and isolate actinobacteria and evaluate their resistance to meningitis-causing bacteria. Twelve prominent isolates were obtained from soil, and after the primary and secondary screening, isolates LA2(R) and LA2(O) were found most significant in the production of the bioactive compound. Its identity was confirmed as *Microbacterium* sp., (NCBI accession no. MN560041) and *Streptomyces rochei* by 16S rRNA sequencing. *Microbacterium* is the least explored species of actinobacteria as per the literature reports. The antibacterial potential of secondary metabolites produced by actinobacteria has been demonstrated by the well diffusion method. GC-MS was used to detect compounds in bioactive metabolites. The most abundant compound found in metabolites was n-hexadecanoic acid. The extracellular synthesis of actinobacteria silver nanoparticles was determined by UV-Vis spectroscopy, while TEM and FTIR examined their morphological appearances, stability, crystalline structure, and coating. Actinobacteria silver nanoparticles and pure metabolites are tested against bacteria that cause meningitis, including *Neisseria meningitis*, *Streptococcus pneumoniae*, and *Haemophilus influenzae*. The results suggest that isolated actinobacteria may serve as a prominent source against bacterial meningitis and having immense applications in the medical sector.

Keywords: Actinobacteria, Bioactive compound, silver nanoparticles, Bacterial meningitis.

Effect of altitude and aspect on vegetation structure, carbon density and soil nutrients in Shankaracharya Forest.

Mohsina Niyaz, Dr. Syed Aasif Hussain Andrabi, Dr. Rayees Afzal Mir, Sajjad Ahmad Khan.

Department of life science (Botany) Global university Saharanpur

ABSTRACT

Phytosociology is defined as the study of composition, development, geographic distribution and environmental relationship of plant communities. The study of plant community implies knowledge of structure and composition of the component species. The combined influence of plant height, basal area, density and number of species on ‘complexity index’ is the evaluation of vegetation physiognomy. The present documentation entitled “Effect of altitude and aspect on vegetation structure, carbon density and soil nutrients in Shankaracharya forest” was carried out. The study site is situated between an altitude of 1575 to 1967 m amsl and latitude of 34°04’35.56” N and 74°51’08.63” E longitude. Shankaracharya hill also known as Takht-i-Sulaiman is a hill overlooking the Dal Lake and Srinagar in Jammu and Kashmir. It is the destination of hundreds of tourists each day. The Phyto-sociological status of the entire reserve forest grove, growth and biomass production of conifers, carbon sequestration by conifers and soil nutrient analysis was worked out at three different aspects along the altitudinal range. The vegetation sampling was done by quadrat method, and the sample quadrats were located by systematic random sampling procedure. Altogether ninety nine quadrats were laid and sampled. Various community attributes (viz. importance value index, species frequency, density, abundance to frequency ratio) were analyzed as per standard procedures. The taxonomic compendium of plant community on Shankaracharya reserve forest included a total of 110 species among them most dominant tree species was *Cedrus deodara*, most dominant shrub was *Viburnum grandiflorum* and most dominant herb species was *Fragaria nubicola*. The species composition and structure further revealed that Shankaracharya reserve grove is *Cedrus-deodara* dominated forest.

Keywords: Vegetation cover, Phytosociology, Shankaracharya hills- Srinagar- J & K, Ecotourism.

STUDIES ON DISTRIBUTION OF FRUIT FLIES (DIPTERA : TEPHRITIDAE) IN MANGO ORCHARDS OF SAHARANPUR DISTRICT OF UTTAR PRADESH

DilMahjoora Majeed* MohdMajidJamali &Rayees Afzal Mir

¹*Agricultural Sciences, Glocal University, Saharanpur 247121, Uttar Pradesh, India*

ABSTRACT

Mango (*Mangifera indica*) is the second major fruit crop cultivated in India, it is known as “King of fruits” owing to delicious quality of fruit with richness in vitamins and minerals and has socio economic significance in international markets. Among the Indian states, Uttar Pradesh tops with the maximum cultivation of Mango. Saharanpur district of U.P has already been declared as important fruit belts of the country due to dense mango orchards.

Fruit flies (Diptera :Tephritidae) are one of the most diverse group of insects, comprising over 4000 species in 481 genera. Knowledge of the Tephritid spectrum in any given area is a prerequisite for the development of an IPM program to alleviate the pest problem. Samplings were carried out in different mango orchard of Saharanpur district according to their fruiting seasons (April to August) with 15 days interval. Samples of fruit flies were collected by using methyl Eugenol lure traps from the farmer’s orchards and stored in 80% ethanol before identification in the labotary. Fruit fly species were identified using stereo-microscope with binocular lens by observing the morphological characteristics. Eight species of fruit flies were recorded from *Bactrocera*genus. The fruit flies identified in the laboratory were *Bactrocera**caudata*(Fabricius), *B. correcta* (Bezzi), *B. cucurbitae*(Coquillett), *B. diversa* (Cocquillett), *B. dorsalis* (Hendel), *B. invadens* (Drew, Tsuruta & White), *B.tau* (Walker) and *B. zonata*(Saunders).

Keywords: Fruit fly, *Bactrocera* sp. Mango, Diversity, Distribution, Diptera, Saharanpur.

Identification of high yielding stable genotypes of finger millet by using GGE Biplot AMMI analysis

Ekhlaque Ahmad* and Abdul Majid Ansari

¹*Zonal Research Station (Birsa Agricultural University), Chianki, Palamu-822102*

ABSTRACT

Finger millet (*Eleusine Coracana* (L.) Gaertn.) is an important small grain crop ranked third in area and production after sorghum and pearl millet in India while in Jharkhand this crop ranks first. Due to the excellent nutritional properties and resilience to climate change, finger millet is also known as nutri-cereal crop. Now a day’s product of this crop suppose to part of super market. The hardy nature of millets has gained them the recognition as the dryland crop. So, why it is generally grown in marginal land having low fertility along with abiotic stresses. Gaining of popularity and demand of this crop, there is urgent need to improve its quality and productivity per unit area. Thus, the requirement of stable genotypes that perform well over a wide range of environments becomes increasingly important over as a farmers need for sustainable production. Development and adoption of appropriate varieties led to increase in area, production and yield of finger millet in Jharkhand. Keeping in view, the present experiment was carried out at Zonal Research Station, Chianki (Birsa Agricultural University), Chianki during *Kharif* 2014 to 2017 in four consecutive years to identify high yielding stable genotypes tolerant to biotic and abiotic stresses by using GGE biplot AMMI model (Yan *et al.*, 2000). A total 15 genotypes of finger millet were evaluated in three replication under rainfed condition of Jharkhand. Data were collected from 10 competitive plants per treatment on seed yield and its attributing characters and subjected to analyzed. From this study it was observed that first two Principal components revealed more than 86 per cent of the variability for the yield which indicates that G and GE together accounted for more than 14 per cent of total variability. Based on the present analysis of using GGE biplot models, considering simultaneous mean yield and stability, the genotypes BBM-10, BBM-11 and VL-149 were relatively stable in all the environments. The environment E1 was discriminative (informative). This environment contributed most to the variability in grain yield. Hence, GGE biplot method is suitable to discriminate the genotypes based on their stable and instability nature across the environments. The AMMI analysis revealed that BBM-10, BBM-11 and VL-149 had wide adaptation and not be affected by the Genotype x environment interaction (G x E); hence may yield better across the environments. E2, E3 and E4 could be considered as good selection sites for identifying broad based and most adaptable finger millet genotypes.

Key words: AMMI analysis, Biplot, fingermillet, stability

Nanotized plant growth regulators and its effect on growth, yield and essential oil production in *Coleus aromaticus*

Naushin Quasar* and M Masroor Akhtar Khan

¹*Plant Physiology, Department of Botany, Aligarh Muslim University, Aligarh-202002 (U.P.), India*

ABSTRACT

Coleus aromaticus is a perennial herb of the Lamiaceae family that grows wild in the tropics and warm climates of Africa, Asia, and Australia. The objective of this research was to see how foliar application of nanotized plant growth regulators, indole-3-acetic acid (IAA), affected the content and composition of this plant's essential oil. Nanoparticles show significantly different properties compared to the same bulk molecules because of much higher concentration of atoms at their surface as a result of ultra-small size. For extracting essential oil, a hydro distillation process utilizing a Clevenger type equipment for 3–4 hours is typically used, and the components were analysed using GC-MS. The results showed a wide variation on content, yield, and range of the molecule constituent of oil. The nanoform of IAA treated plant of *Coleus aromaticus* proved to be the best with an improvement of 150% of increase EO content and 40.0% yield over the control. On the other hand chemical constituents particularly rich in phenolic monoterpenes such as Thymol(29.71%), caryophyllene(26.05%), Carvacrol(9.07%), and humulene(4.30%) were also reported which are speculated to exert various pharmacological properties.

Present Status, Problem and Prospect of Duck Farming in Kolhan Region of Jharkhand

Pankaj Seth¹, Sushma Lalita Baxla² and Jagarnath Oraon³

¹*Krishi Vigyan Kendra, Saraikela-Kharsawan, Birsa Agricultural University, Ranchi -834006 (Jharkhand), India*

²*Krishi Vigyan Kendra, Garhwa, Birsa Agricultural University, Ranchi - 834006 (Jharkhand), India*

³*Director Extension Education, Birsa Agricultural University, Ranchi -834006 (Jharkhand), India*

ABSTRACT

Indigenous ducks are still preferred by the farmers and proved to be a sustainable livelihood proposition for several poor rural farmers. The study was carried out to know the present status, existing production system of duck and assess the potentiality of duck rearing in two districts purposively East Singhbhum and Saraikela-Kharsawan in Kolhan region of Jharkhand. The data were collected using semi structure interview schedule from 160 farmers selected from four blocks randomly Potka and Patamda of East Singhbhum, Gamharia and Kharsawan of Saraikela-Kharsawan district respectively. The result revealed that majority of the duck rearing farmers (63.45%) were middle aged and 25 per cent farmers were illiterate. Most of the farmers (72.10 %) reared *desi* duck and average flock size per household was found 15.54. The majority of farm women (67.23%) were responsible for duck rearing. It was observed that farmers reared duck in scavenging (58.40 %) and semi-Scavenging system (41.60%) respectively. The 54.78 per cent farmers have used wood/bamboo, plastic net and tin for construction of duck house and 32.24 per cent farmers used bedding materials for their duck house. All duck rearing farmers used kitchen waste, broken rice and rice huskas feeding materials for duck. The 36.37 per cent farmers have provided on an average of 125.65g supplemental feed to each duck/day and cost of the feed was Rs. 1.20/duck/day. Most of the respondent farmers (68.35%) have provided feed to their ducks twice a day. The result showed that age and weight of duck at maturity were 181.6 days and 1.56 kg respectively. The average egg production/duck/year and average weight of egg were found 118.5 numbers and 65.7g respectively. Most of the farmers (56.78%) incubated duck egg under broody hen and they have got 76.63 per cent hatchability on set eggs. The majority of the farmers (57.21%) mentioned that most prevalent disease of duck was cholera and their duck mortality was 17.29%. The respondent farmers (62.89%) farmers controlled their duck disease with medication and only 34 per cent farmers were used vaccine to prevent duck disease. Majority of the farmers (56.34%) incubating duck eggs for ducklings and about 63 per cent farmers purchased duckling by Rs. 35-40 from organized duck farm and 58 per cent farmers were sold adult duck by Rs.325-350 in local market. Majority of the farmers (64.26%) have stated that the duck farming is increasing day by day and motivated to convert in to improved duck farming and about 48.28 per cent duck farmers have stated that they have started rearing of Khaki Campbell, White Pekin and Indian Runner duck breeds in their farm. It was concluded that scientific duck rearing knowledge and adoption of the farmers such as breeding, feeding, housing, prevention and control of diseases are not satisfactory in the study area. Introducing of improved duck breeds/varieties, capacity building and skill training to duck farmers, ensuring vaccination to ducks, financial and technical support to the farmers could increase the duck rearing practices with doubling farmers' income and employment to youth, rural women and the small-holder marginal farmers.

Key words: Problem, Prospects, Duck Farming, Semi-Scavenging System, Jharkhand

DELINEATION OF GROUND WATER POTENTIAL ZONES USING REMOTE SENSING, GIS AND GEOPHYSICAL TECHNIQUE IN HARAHUA BLOCK, DISTRICT VARANSI, UTTAR PRADESH

Dr. Ritu Jain

¹ Department of Geography, National P.G. College, Lucknow

ABSTRACT

The present level of groundwater tables is falling at a rapid rate due to the withdrawal of groundwater being high in comparison to the recharge of groundwater. The research work on delineation of ground water potential zone in Harahua block, District Varanasi, Uttar Pradesh is based upon the scientific investigation of the Hydro-Geomorphology, Lithology, Drainage, Soil, Slope, Land use land cover and Geo-resistivity data. This work covers the spatial analysis for the identification of suitable structure and location for Harahua block, Varanasi district using satellite data with the help of Geographical Information System (GIS), Remote Sensing and Geophysical technique. In this study Landsat-8, Sentinel data and softwares were used for analysing the data using classification method. Digital Elevation Model (DEM) and slope maps were prepared using Shuttle Radar Topographic Mission (SRTM) data. Thematic layers were prepared using GIS for base map, drainage, canal, water body, lithology, drainage, contour, soil, hydro- geomorphology and land use land cover. Analysis of ground water level through geophysical technique, thematic map like vertical electric sound location, cross section, top soil, clay thickness, saturated zone thickness, aquifer thickness, and depth to ground water was carried out. Criteria for GIS analysis have been defined for the groundwater potential capacity according to the weightage through weightage overlay method. The result were categorized based upon the four categories i.e. Excellent, Good, Moderate and Poor. Only the excellent and good categories are suitable for establishing rainwater harvesting structure. Results indicated that, for the block of Harahua 1.81% of the area was classified to excellent, 40.22% of the area was classified to excellent to very good, 46.66% of the area was classified to very good to good, 9.22% of the area was classified to Moderate ground water potential and 2.09% of the area was classified as poor. **Key Words:** - Ground Water Potential, Remote Sensing, GIS, Resistivity Data, SRTM Image, DDR-3 Machine, Sentinel Data

Growth and biomass production of *Bombax ceiba* L. plantations after six years in relation to stand density

Rodda Chandana Devi, D.K. Das and S. Pazhanisamy¹

¹Department of Soil Science, Dr. Rajendra Prasad Central Agricultural University, Pusa (Samastipur) – 848125, India

²Department of Forestry, Dr. Rajendra Prasad Central Agricultural University, Pusa (Samastipur) – 848125, India

²Department of Agronomy, Dr. Rajendra Prasad Central Agricultural University, Pusa (Samastipur) – 848125, India

ABSTRACT

The field experiment was conducted to quantify the growth rate and biomass production of six-year-old *Bombax ceiba* L. plantations by four different plants spacing (5 × 2m, 5 × 3m, 5 × 4m and 5 × 5 m) in calciorthent of the north-west alluvial plain of Bihar. Tree parameters had measured, height, diameter at breast height (DBH), and crown width. Two widest spacing (400 and 500 trees/ha) had height and DBH values on average 19% and 26% higher than the narrow spacing (1000 and 666 trees/ha), respectively. The crown width of the tree did not show any marked difference with the density of the plantations and it varied between 3.56 – 4.39 m. Also, timber volumes were found significantly superior under the lower density of the plantation and found maximum in 5x5m spacing (0.158 m³ tree⁻¹). The maximum total biomass (26.5 Mg ha⁻¹) was observed in the plantation spaced at 5 × 2 m, followed by the biomass (25.8 Mg ha⁻¹) of the plantation with the spacing of 5 × 4 m. Of these, *B. ceiba* showed that the total amount of above- and below-ground biomass accumulation was 10.83 and 4.65 kg/tree, respectively. The overall contribution of stem, branches and the leaves to the total AGB was 77.1 %, 17.0 % and 5.9 %, respectively.

Key words: Above ground biomass, below ground biomass, *Bombax ceiba*, Growth and Plant spacing

Investigation of the allelopathic potential of *Parthenium hysterophorus* L. and *Pinus roxburghii* Sarg. on Tulsi (*Ocimum tenuiflorum*)

Monali Chauhan*, Sonam rawat, Pallavi Sati, M.C. Nautiyal

¹Plant Physiology research centre (HAPPRC), H.N.B. Garhwal University, Post Box: 14, Srinagar Garhwal, 246174, Uttarakhand, India

ABSTRACT

3rd International Conference on “Global Initiative in Agricultural, Forestry and Applied Sciences for Food Security, Environmental Safety and Sustainable Development (GIAFAS-2021)”

Allelopathic potential of an exotic herb *Parthenium hysterophorus* L. and an indigenous tree *Pinus roxburghii* was critically evaluated by physiological and biochemical attributes. All the disciplines were critically explored by using a number of reliable indices which can justify the allelopathic property of the two experimental species. The allelopathic potential of aqueous extract of different parts viz, leaf, root, flower and stem of *P. hysterophorus* and needle leachates of Pine leaves on the seed germination and early growth stages of Tulsi was evaluated at 1 %, 2%, 5% and 10% concentrations. The control group was given distilled water. It was found that all the four extracts of *P. hysterophorus* caused a general phytotoxic effect on seed germination and seedling growth on Tulsi at high concentrations. The inhibitory effect was pronounced at higher concentrations, whereas a little stimulatory effect was seen at lower concentrations in some cases. The inhibitory effect was more pronounced in root and flower extracts as compared to stem and leaf extracts. However, in case of Pine leachates, stimulatory effect was seen in all concentrations and germination was not inhibited even in higher concentrations. Thus, from this study, it can be conclusively established that *Parthenium* can render allelopathic action while Pine shows no such action on germination and growth of Tulsi.

Keywords: Allelopathy, leachates, aqueous, seedlings, germination

EFFECT OF CIRCULAR SAW BLADE’S CONSTRUCTIONAL AND OPERATIONAL FEATURES ON CUTTING TORQUE REQUIREMENT IN CONTEXT OF HENNA HARVESTING

Shital Sonawane¹, A.K. Mehta², Ajay Kumar Sharma³, S.S. Meena⁴, N.L. Panwar⁵

^{1,2,3,4}Department of Farm Machinery and Power Engineering, College of Technology and Engineering, MPUAT, Udaipur.

⁵ Department of Renewable Energy Engineering, College of Technology and Engineering, MPUAT, Udaipur.

ABSTRACT

Henna harvesting is considered as a power intensive operation. The given study was focused on the investigation of effect of various blade and operational parameters for selection of efficient cutting system for henna harvester. The effect of blade type, cutting speed and diameter of henna stem were observed on the cutting torque and specific cutting energy at constant moisture content. The experiment was conducted with three parameters i.e., blade type, cutting speed and henna stem diameter to find the effect on cutting torque. The average cutting torque values for three carbide tipped blades lies between 3.12- 4.18 N.m, while average cutting torque for regular brush cutter blade was 18.82 N.m. The cutting torque was having inverse relation with the rotational cutting speed. The average cutting torque at lowest rotational cutting speed i.e., at 600 rpm was 9.18 N.m while at highest rotational speed i.e., 1200 rpm it was 6.31 N.m. It was observed that at higher rotational speed i.e., at 1000 and 1200 rpm cutting operation was somewhat noisy due to speed induced vibrations. The cutting torque showed a linearly proportional relationship with diameter of stalk. The specific power requirement for regular brush cutter blade was highest compared to carbide tipped blades. The three-carbide tipped circular saw blades was selected under study were showed good torque characteristics and demanded lesser torque compared to the regular brush cutter blade. Based on the results the carbide tipped blade with 120 teeth at 1200 rpm was recommended for the henna harvester.

Keywords: Carbide tipped blade, Henna Harvesting, Henna Harvester, Specific Cutting energy. Highlights
The carbide tipped blade had lowest torque. The specific cutting power is highest for regular brush cutter blade. Rotational blade speed showed strong negative correlation with the cutting torque.

Revival and contemporizing of traditional Khana doobby designs into jacquard woven kurta materials

Pratikhya Badanayak^{1*} and Sadhana D. Kulloli¹

¹Department of Textile and Apparel Designing, College of Community Science, University of Agricultural Sciences, Dharwad-580005, Karnataka, India

ABSTRACT

Khana is a piece of handwoven cloth (blouse) fashioned with a texturized blend of cotton in the warp and silk in the weft devising a width of 80cm and length of 50cm. These elegant blouse materials are extensively woven in the Guledgudda region of Karnataka. Initially the design of Khana is only limited to blouse materials but owing to variety

3rd International Conference on “Global Initiative in Agricultural, Forestry and Applied Sciences for Food Security, Environmental Safety and Sustainable Development (GIAFAS-2021)”

in fashion today, variegated textiles including sarees, dupattas and other useful textiles were produced. In this study an attempt was made to revise and contemporize the traditional dobby designed Khana motifs into jacquard woven kurta materials. Herein, a total of 10 traditional Khana motifs were collected, resized and contemporized using coral draw. With aiding elements and principles of design a total of three kurta patterns were designed in Adobe Photoshop and subsequently woven in a power-loom with sustaining jacquard mechanism. The prominence of revising traditional designs, ethnicity, design perspectives, suitability and appropriateness were evaluated using a self-structured questionnaire by 30 students and 30 women. Later all the developed designs were highly appreciated and well accepted by the selected respondents with regards to visual evaluation.

Key words- CAD, power-loom, Khana motifs, kurta materials, revival, traditional motifs

Impact of Joint Forest Management Programme on livelihood of Rural People in Jammu Division of Jammu and Kashmir

***Tariq Iqbal¹, P.S. Slathia¹, Rajinder Peshin¹, Sandeep Sehgal², Manish Kumar Sharma³, Kiran Kour⁴, Rakesh Kumar¹, S.K. Gupta², and Bharat Bushan⁵**

¹Division of Agricultural Extension Education, FoA

²Division of Agro-forestry, FoA

³Division of Statistics and Computer Applications, F.B.Sc

⁴Division of Fruit Science, FoA

⁵Joint Registrar Academics-SKUAST-J Sher-e-Kashmir University of Agricultural Sciences and Technology of Jammu

ABSTRACT

The study was conducted in purposively selected “East Forest Circle” of Jammu division. Multistage sampling plan was followed for the selection of respondents. Six forest ranges from East circle having maximum number of JFMCs were selected purposively. Twenty four committees, four from each selected ranges of East circle were selected through random sampling technique. Eight members from each selected JFMC were selected randomly as treatment group for the study making the sample size to 192 respondents. Two villages from each range (12 villages in total) were also selected through simple random sampling technique. From each selected village nine non- JFMC members were randomly selected. Thus, a total sample of 108 non-JFMC members was selected as control group from these villages. Thereby making a grand sample of 300 respondent including both JFM and Non-JFM respondents were interviewed for assessing the impact of Joint Forest Management Programme. Findings of research showed that majority of the JFM members were solely dependent upon agriculture as only source of income. Significant improvement was observed in total number of trees planted, increase in forest cover and increase in different plant species due to implementation of JFM programme. Enhancement in production of milk, fodder and fuel wood was also observed in the study area. JFM had significant impact on the overall income of the households falling in its area of operation.

Key words: Joint Forest Management, Ranges, Impact, Livelihood, Production, Fodder.

A review on Process Technology for Milk Cooling and Chilling

Kumar Ashok¹, Jain SK², Jain NK², Lakhawat S S², Kumar Arun²

¹Bihar Agricultural University, Sabour, Bhagalpur-813210, Bihar, India

²Maharana Pratap University of Agriculture and Technology, Udaipur-313001, Rajasthan

ABSTRACT

India is one of the largest milk producing nations in the world. India's milk production is growing by 35.61 percent during the last six years to 198.4 million tonnes in 2019-20. Production of milk is very widely scattered in the rural areas and at vast distances from the places of high consumption in the urban area. High ambient temperature throughout the year in India causes a disadvantage since the bacterial growth is very rapid if the temperature of milk, as produced, is not brought down, immediately after production. (Economic Survey 2020-21). In India, milking of animal is done either at community milking center or at the houses of the farmers. In most of the other parts, milking is done at the farmer's home and then delivered to the village cooperative centers. At the community milking centers, animals are brought and milking is done which is collected and then sent to the chilling centers. Milk cooling is one of the most indispensable technology before processing of milk and milk products. The improper post handling of milking handling and storage results in a complete wastage due to the microorganisms and bacterial multiplication present in raw milk. It is the factor which is responsible for deciding the quality of end product. Various methods of milk cooling has already been devised but due to small milk production size, lack of awareness and absence of infrastructural support, milk producers from rural areas do not do not inclined for milk cooling devices. Bulk Milk Coolers are an important tool in

maintaining the cold chain of milk between the producers of rural area to the processing at main dairy plant. It provides the cooling and holding milk at a cold temperature until it can be picked up by a milk hauler. The collection and transportation of milk presents several techno-economic problems in tropical countries. Cooling the milk is accepted as the best means of preservation of milk quality (Bjorcket *al.*, 1979). This paper deals with need of cooling, bacteria growth process, methods of cooling systems, design aspects and their performance and assess feasibility of milk.

Keywords: Cooling, Chilling, Milk, Bulk milk cooler, refrigeration

REFERENCES

Bjorck, L.J., Claesson, O. and Schulthess, W. 1979. *Milchwissenschaftler*,34:726-729.

Economic Survey 2020-21, Dept. of Economics Affairs Economic Division, Government of India, New Delhi, Vol.1

Trichoderma and Nanotechnology: Combining Biocontrol with Bio-efficacy

Efath Shahnaz*, Saba Bandy, Ali Anwar, QadrulNisa, Gazala Gulzar and T. A. Sofi

¹*Division of Plant Pathology, Faculty of Horticulture, Sher-e-Kashmir University of Agricultural Sciences & Technology of Kashmir, Shalimar Campus, Jammu & Kashmir, India 190 025*

ABSTRACT

Nanotechnology is an emerging and fast growing field of research and biogenic synthesis has been gaining impetus because of its number of attractive benefits over various physical and chemical methods like being simple, yet cost effective, generate low amount of toxic waste, have low energy requirements and at the same time provide greater yields. The various organisms used for biogenic synthesis are bacteria, yeasts, fungi and algae which act as reducing agents and stabilizers. These organisms alter the chemical nature of metals by developing a mechanism of defence against toxic agents and in the process, prepare nanoparticles with low toxicity. This process of extracellular biogenic synthesis is probably mediated by the nitrate reductase enzyme, which acts in the reduction of metals, leading to the formation of nanoparticles. The nanoparticles so developed can be used for the production of slow release pesticides and fertilizers, nano-sensors for the detection of pesticides in the environment as well as management of diseases. The important nanoparticles developed are silver, gold, copper, silica and selenium nanoparticles and the important fungi capable of biogenic nanoparticle synthesis are *Aspergillus terreus*, *Trichoderma harzianum*, *T. virens*, *T. asperellum*, *T. pseudokoningii* and *T. longibrachiatum*. *Trichoderma* is an important bio-control agent used against a number of phytopathogens having number of modes of action like competition, hyperparasitism, antibiosis and induced systemic resistance. In addition to these benefits silver and gold nanoparticles synthesized by *Trichoderma* spp. have been found to be stable and polydispersed globular particles ranging in size from 1 to 50 nm, with significant anti bacterial activity. The silver, gold, copper, silica, zinc and selenium nanoparticles produced with the help of various *Trichoderma* spp. were found to be effective against *Sclerotinia sclerotiorum*, *Sclerosporagraminicola*, *Fusarium verticillioides*, *F. moniliforme*, *Penicillium brevicompactum*, *Helminthosporiumoryzae*, *Pycularia grisea*, *P. oryzae*, *Poriahypolateritia*, *Phomopsisstheae* and *Alternaria alternata*. Thus there is a tremendous potential of using biocontrol agents like *Trichoderma* for the production of nanoparticles which in turn can be used effectively for various agricultural purposes.

Molecular identification of host-specific phytopathogens isolated from *Macrotyloma uniflorum* plant and assessment of their potential bio-control agents

Pooja Pant¹, Ankit Negi¹, Sushma Tamta² and Rishendra Kumar^{1*}

¹*Department of Biotechnology, Sir J. C. Bose Technical Campus, Bhimtal-263136, Kumaun University, Nainital, Uttarakhand, India*

²*Department of Botany, D.S.B. Campus, Kumaun University, Nainital-263001, Uttarakhand, India*

ABSTRACT

Macrotyloma uniflorum (Lam.) verdc is a pulse crop plant with huge nutritional and medicinal properties. It is highly resistant to abiotic stresses such as drought, heavy metals and salinity while, some of the biotic stresses caused by harmful pathogens affect the growth and yield of susceptible crop varieties by causing the rot diseases in different plant parts. The aim of the present work was isolation and identification of certain host-specific phytopathogens causing the rot disease in *M. uniflorum* plant cultivated in Bhimtal, Uttarakhand. The fungal culture were isolated from different plant parts (leaves, stem and pod) and were authenticated by molecular identification based on rDNA ITS sequence analysis. The identified strains were phytopathogens namely *Macrophominaphaseolina*, *Nigrosporaoryzae*, *Boeremiaexigua* and *Phomopsis* sp. Further; the rhizospheric fungal strains were isolated from *M. uniflorum* plant variety which is resistant to diseases like, Anthracnose, leaf and stem rot. These isolates were used as bio-control agent against the isolated phytopathogens in in-vitro antagonistic tests using the dual culture plate antagonism assay method. Among all rhizospheric fungal isolates, five fungal strains were selected on the basis of their maximum percent inhibition

3rd International Conference on “Global Initiative in Agricultural, Forestry and Applied Sciences for Food Security, Environmental Safety and Sustainable Development (GIAFAS-2021)”

against *Macrophomina phaseolina*, *Nigrospora oryzae*, *Boeremia exigua* and *Phomopsis* sp. These Rhizosphere fungal strains were examined morphologically and have been sent for further molecular identification.

Keywords: Phytopathogens; Molecular identification, *Macrotyloma uniflorum* (Lam.) verd., Bio-control

Effect of Land Configuration and Integrated Nutrient Management on Growth, Yield and Economics of Pigeon pea (*Cajanus cajan* L. Millsp.) Under Rainfed Condition”

Neha Singh Kirar D.S. Sasode Varsha Gupta R.P. Prajapati

¹Department of Agronomy, RVSKVV, College of Agriculture, Gwalior-474002, India

ABSTRACT

The field experiment was conducted during *kharif* season of 2018 and 2019 on sandy clay loam soil at the Research farm, College of Agriculture, Gwalior (M.P.) to find out the suitable land configuration and integrated nutrient management. Treatment consists of eighteen treatment combinations comprising three land configurations in main plot whereas, six integrated nutrient levels in sub plot. Main plot Land Configuration C₁-Flat bed, C₂-Ridge and furrow, C₃-Opening of furrow after two rows and Sub plot Integrated Nutrient Management F₁:50% RDF + PSB, F₂:75% RDF + PSB, F₃:100% RDF + PSB, F₄: 125% RDF + PSB, F₅: 50%RDF+5t/ha, F₆: 50%RDF+2.5t/ha vermicompost. The treatments were assigned in split plot design. Application of 50% RDF + 2.5t/ha vermicompost grown on Ridge and furrow obtaining higher values all growth attributes viz., Plant height, and number of branches⁻¹; yield viz., seed and straw yields of better quality and maximum economic returns by sustaining soil fertility of pigeonpea.

Keywords: Land configuration, Integrated nutrient management, pigeonpea, Ridge and furrow and Flat bed.

Agroforestry- alternative land management for sustainable development

Supriya K Salimath^{1*}, Deepthi Dechamma N L¹, Clara Manasa P A¹, Maheshwarappa V¹ Ramakrishna Hegde¹ and Ashwath M N²

¹Department of Silviculture and Agroforestry, College of Forestry, Ponnampet, University of Agricultural and Horticultural Sciences, Shivamogga, Karnataka, India.

²Department of Forest Biology and Tree Improvement, College of Forestry, Vellanikkara, Kerala Agricultural University, Thrissur, Kerala, India.

ABSTRACT

Agroforestry is a land management system that increases production and ecological stability and contributes to the sustainable development of the agroecosystem. It addresses the nation's land stewardship needs by converting degraded lands, protecting sensitive lands and diversifying farm production systems. Deliberate planting of the tree, shrub and herbaceous legumes in rotation with food crops has become a central and integral part of land management practices for replenishing soil fertility in nutrient-depleted small-scale farms. However, owing to the limitation of site for the crop growth in terms of growth resources, efficient utilization of resources is a key for the success of agroforestry systems. The productivity of any vegetation system mainly depends on biomass production and carbon storage potential in their different components, which are affected by nature, age of plant and other climatic, edaphic, topographic and biotic factors. In this context, the biomass production and allocation in agroforestry systems need to be understood to manipulate them for higher gain. Hence, an attempt has been made in this review to explore productivity components of agroforestry and the factors influencing biomass production and allocation. With this knowledge, managers can apply suitable silviculture and management practices to manipulate the biomass production within the system and allocate them as beneficial to the farmer both economically and ecologically.

Key Words: Agroforestry, sustainable, productivity, biomass production, allocation.

Seasonal Effect on Physicochemical Properties of Soil Samples from test sites of Bamboo Plots

Dr. Abha Jha¹ and Dr. Mrs. Sunila Das²

¹. HPS College Nirmali, BNMU Madhepura 2.Retd. Associate Professor C. M. Sc. College Darbhanga, LNMU

ABSTRACT

An experiment was conducting to study the physical and chemical characteristics of different sites of Bamboo-plots of North Bihar region. Some selected physical soil properties were recorded in three different seasons. Soil samples were collected from selected bamboo plots. The soil properties like soil pH, % of sand, silt, EC, soil-moisture, organic carbon, available N, P, K, calcium, magnesium at two soil-depths i.e., 0-25 and 25-45cm. There are influence of seasons on the physicochemical properties of soil of Bamboo-plot reveal that soil of all the bamboo-plots is alluvial and loam in

texture as also observed by Raychaudhary (1966). It is rich in humus and calcium content. The colour of the soil during winter and early summer was light grey due to low amount of organic matter. Soil temperature is an important edaphic factor which effects entire physicochemical property of the soil and its abiotic potentiality. It controls the rate of decomposition, which is the source minerals return to the soil. According to Alexander (1961), the role of decomposition is accelerated by increasing the temperature due to increased bacterial activities. The conductivity in both the cases varied between 206mho/cm-489mho/cm. pH varied between 6.2-6.9 and alkalinity varied between 1.0mg/100g-1.08mg/100g.

Key words: Season, Physicochemical properties, Soil, pH, EC, alkalinity.

Ginger Exports from India: A Markov chain analysis

Namami Gohain¹, Surbhi Bansal², Shruti Mohapatra³

^{1,2}*Punjab Agricultural University, Ludhiana*

³ *Sri Sri University, Cuttack, Odisha*

ABSTRACT

The global ginger & ginger processing market was valued worth of **US\$ 2.16 billion** in 2019 proliferating at a CAGR of 6.6% (India Business and Trade). Out of which Indian exports was valued at US\$ 44.5 million. The paper attempts to study the trend of ginger trade in India using simple tabular analysis and quantify the changing structure of ginger export. Data for analysis was taken for a period of 14 years from 2005-06 to 2019-20. We used the Markov Chain Analysis through linear programming method to assess the transitional probabilities for the major ginger markets. Results showed that India stood fifth in terms of global ginger exports in 2019 and trade surplus for the country during the study period. The major Indian ginger export markets were categorized as stable market (UK) and unstable market (Bangladesh) based on the magnitude of transitional probabilities. The major export market for ginger crop were UK (66.08 percent), Morocco (49.35 percent), USA (10.23 percent) and Saudi Arab (9.88 percent). The forecast value for, Saudi Arab and other countries show the increasing trend and the countries USA, Bangladesh, Morocco show the decreasing trend and UK show the negligible change in it. The holistic conclusion leads to the need of emphasizing on productivity enhancing research, measures to stabilize existing markets and tapping other market section for improvement in this sector.

Keywords: Ginger, export trend, Markov chain analysis, transitional probabilities, trade surplus

INVESTIGATION ABOUT THE LIPID COMPOSITION OF SOME FRESHWATER FISHES

Dr. Basant Kumar¹ and Dr. Abha Jha²

¹*Agriculture Manager, AKRSPI (Bihar) Assistant Professor (Guest)H.P.S. College Nirmali, BNMU, Madhepura*

ABSTRACT

In this work we were study about the lipid composition of some fresh water fishes collected from Darbhanga locality. Fish is consumed in this Gangetic plain mainly for protein and lipids. Fishes contain unsaturated fatty acids as lipid-component. Accordingly, the study was conducted by selecting two river stretches of Darbhanga District. These included stretches of river Kamala located in village Pokharam and stretches of river Balan located in village Pohaddi. Fish collections was done with bag nets of standardized dimensions with several mesh-sizes. There is selection of *Labeorohita*(Rohu), *Labeocalbasu* and *Catlacatla* a plankton feeder, phytoplankton and detritus feeder respectively in water column. The health clues hidden in fish flesh consumption encountered through popular dailies and reviews (The Times of India, Sunday review, July.18 Aug.8 and Aug.22 and Dec.18, 2001) attracted the present attention on this particular problem. According to fat extraction by Soxhlet extraction method; fat content of *Labeorohita* varied between 23-30% while the iodine value was in range of 90-102. The level of triglyceride could be measured between 402-410 mgm (%). The saponification value was recorded between 101-171.2 and acid value between 8.81 and 9.21. Whereas, the fat contents of *Catlacatla* was recorded between 24.6-26.7%. Iodine value in the range of 96-97, saponification value between 152.4-158.7 and acid value between 7.8-8.61. These values in *L. calbasu* were recorded as: fat content 25.6 - 27.1%; Iodine value 96-98; Saponification value 133.4-140.3 and acid value 6.93-7.6. The findings suggest that the total fat content in all the major carps were comparable to each other. The study also suggests that in general the fat content of fish increases during winter season probably on account of availability of quality food. However, with regard to ω_6 and ω_3 profile the *Labeorohita* and *Labeocalbasu*the phytoplankton and detritus feeders respectively shows a better range of ω_3 fatty acids than *Catlacatla*, a zooplankton feeder which appears to be rich in ω_6 fatty acids.

Key Notes: Fresh Water Fishes, Fatty acids, Fat content, Iodine value, Saponification value, ω_3 , ω_6 profile.

THE PROCESS OF MAKING FOSSILS RECORD MORE WIDELY APPLICABLE

Shivam Mani Tripathi

¹Department of Anthropology Sam Higginbottom University of Agriculture, Technology & Sciences Prayagraj, Uttar Pradesh, India.

ABSTRACT

Many cutting-edge paleobiological analyses are performed on the normal degree, an exercise predicated on the validity of genera as significant proxies for species. Uncritical utility of genera in such analyses, but, has led—perhaps inadvertently—to the unjustified reification of genera in an evolutionary context. Even as the utility of genera as proxies for species in evolutionary research ought to be evaluated as an empirical trouble, in practice it's far more and more assumed (rather than verified) that genera are suitable proxies for species. This is problematic on each ontological and epistemological grounds. Genera are arbitrarily circumscribed, non-equivalent, frequently paraphyletic, and every so often polyphyletic collections of species. They are useful tools for communication however have no theoretical or biological reality in their very own and, whether monophyletic or no longer, cannot themselves perform inside the evolutionary system. Attributes considered crucial for knowledge macroevolution—e.g., geographic tiers, area of interest breadths, and taxon intervals—are regularly variable amongst species inside genera and will be inflated at the common stage, specifically in species-rich genera. Consequently, the means (s) of results attained at the prevalent level might not “trickle down” in any obvious way that elucidates our understanding of evolution on the species stage. Ideally, then, evolutionary research that are sincerely approximately species have to be pursued the use of species-stage statistics rather than proxy facts tabulated using genera. where genera are used, greater essential interest need to be centered at the degree to which attributes tabulated at the normal degree replicate biological homes and tactics on the species level.

Key Words: paleobiological, genera, trickle down, evolutionary research, species level

“Studies on the Chickpea (*Cicer arietinum* L.) wilt in relation to variation in the pathogen (*Fusarium oxysporum*f. sp. *ciceri*) and its eco-friendly management”

Mohammad Faisal and Shashi Tiwari

¹Department of Plant Pathology, Sam Higginbottom University of Agriculture, Technology and Sciences, Prayagraj, Uttar Pradesh-211007

ABSTRACT

Chickpea (*Cicer arietinum* L.) is the world's third most important pulse crop, after dry beans (*Phaseolus vulgaris* L.) and dry peas (*Pisum sativum* L.). In India, it is one of the most important pulse crops widely called as ‘Chana’, accounting for 71% of world production of gram. Fusarium wilt (*Fusarium oxysporum*f. sp. *ciceri*) is a major constraint to chickpea production worldwide and estimated to cause 10 - 15% yield loss annually. Hence, a study entitled “Studies on the Chickpea (*Cicer arietinum* L.) wilt in relation to variation in the pathogen (*Fusarium oxysporum*f. sp. *ciceri*) and its eco-friendly management” was carried out during Rabi seasons in 2014-17 at Central Research farm and Research Laboratory of Department of Plant Pathology, Sam Higginbottom University of Agriculture, Technology and Sciences, Prayagraj to survey and observe the variability among the isolates of *Fusarium oxysporum*f. sp. *ciceri* from various locations of Prayagraj, its adjacent districts. Further field trials were carried out by intercropping of three different crops, viz. mustard, lentil and wheat in different patterns. The patterns were (2Ch: L: 2Ch), (2Ch:M: 2Ch), (2Ch: W: 2Ch), (Ch: L: Ch: L), (Ch: M: Ch: M), (Ch: W: Ch: W), (M: Ch: L: W) and control (Ch: Ch: Ch: Ch). Another, field trial was taken up by dressing the seeds with bio-agent, botanicals and their different combinations such that the treatments were T₁ *Trichoderma viride*@ 50 g/kg seed (w/w)+ *Pseudomonas fluorescens*@ 50 g/kg seed (w/w)+ NSKE @ 50 ml./ kg seed (w/v), T₂ *T. viride*@ 50 g/kg seed (w/w)+ *Pseudomonas fluorescens*@ 50 g/kg seed (w/w) T₃ *P. fluorescens*@ 50 g/kg seed (w/w) + NSKE @ 50 ml. /kg seed(w/v), T₄*T. viride*@ 50 g/kg seed (w/w) +NSKE 50 ml. /kg seed (w/v), T₅*Trichoderma viride*@ 50 g/kg seed (w/w), T₆*Pseudomonas fluorescens*@ 50 g/kg seed (w/w), T₇ Neem seed kernel extract @ 50 ml. /kg seed (w/v). Results of survey showed that the Prayagraj (Meza Rd.) [L₁- 28.01] had the highest disease incidence and lowest disease incidence percent was recorded at Satna [L₁₄- 12.07]. All the isolates procured had the similar types of characteristics as illustrated by the previous researchers and showed variable degree of pathogenicity. There were also significant variations in morphological characteristics as per the radial growth observations, conidial measurements, colour of the mycelium, pattern of mycelium and pigmentation on medium. In the field trial, *T. viride*@ 5%+*P. fluorescens* @ 5%+ NSKE @ 5% was best effective attaining the maximum height of (26.62 cm), maximum number of branches (15.13) and maximum disease reduction (13.89%) with maximum yield

(12.44q/h). On the other hand, the trial carried out incorporating three crops in different patterns, revealed that pattern P₆- 2Ch: 2W: 2Ch had the best plant population (18.92), plant height (26.92) and minimized disease incidence (8.15%).

Keywords: Chickpea, *Fusarium oxysporum* f. *spiciferi*, eco-friendly, variability, isolates, bio-agent, botanicals.

Effect of soy protein isolate as foaming agent on the physicochemical properties of the persimmon (*Diospyros kaki* L) fruit pulp during foam mat drying

Anjum Ayoub

¹Food Science and Technology division, SKUAST Jammu

ABSTRACT

A study was performed to assess the impact of soy protein isolate as foaming agent on the physicochemical properties of the persimmon pulp during foam mat drying in the Food Science and Technology division, SKUAST Jammu. During the study, it was observed that with the incorporation of foaming agent in persimmon pulp there were significant increase in mean values from treatment T₁ (control) (PP:SPI::100:00) to treatment T₆ (PP:SPI::50:50). The treatment T₆ in persimmon pulp recorded maximum crude protein 12.11, ash 0.65 per cent, crude fat 0.20, solubility 79.5 per cent, total sugar 18.00 per cent, ascorbic acid 16.98 mg/100g, antioxidant activity 89.12 per cent, total phenols 5.60 mg GAE/g, FRAP value of 2.90. Whereas, the Treatment T₁ (control) recorded maximum L* value 99.6, TSS^B value of 15.12, moisture content of 76.83, carbohydrate content of 7.98 in persimmon pulp incorporated with soy protein.

Keywords: Soy protein isolate, Foam mat drying, Persimmon pulp

Survey on timber yielding plants of six tehsel of district Rampur

Sompal Singh,

¹Mohammad Ali Jauhar University Uttar Pradesh, India

ABSTRACT

The present study is based on the preliminary survey on timber yielding plants of six tehsel of district Rampur during 2019-2020. The study reports on 27 timber yielding plants belonging to 48 species and 21 families, along with their utility. Among all families Moraceae is dominant with 10 species followed by Myrtaceae and Mimaceae with 5 and 4 species respectively. Peoples of this area possess good knowledge of plants used for different purposes, but their continuous exposure to modernization may result in extinction of the species. The survey of this study concluded that, all parts of plant including root, shoot, bark, leaves fruits etc. can be used for packaging, paneling, carriages, furniture, and carpentry of all kinds and traditional medicinal purpose which will promote forest conservation and plant diversity research through extensive survey, afforestation, reforestation and forest rehabilitation. Apart from this, in future, study will be utilized as a reference of plant species distribution and availability in Rampur District of Uttar Pradesh India.

Intervention under use of value Added Jaggery for Increasing

Rashmee Yadav¹ Brij Vikash Singh² and SaritaBharti³

¹) KVK, Auraiya

²KVK lalitpur Hemoglobin level of Adolescent Girl in Auraiya District (UP)

ABSTRACT

The present investigation studied on Deficiency of Hemoglobin in adolescent girl at village of Kutubpur, Block Bhagyanagar, District Auraiya. Krishi Vigyan Kendra Auraiya, conducted an On Farm Trial on Intervention of value Jaggery of Increasing Hemoglobin level of adolescent girl. T1- General diet T2- General diet+ value added Jaggery. The analysis of data revealed that intervention of value added Jaggery (80%) + white sesam seed (20%) for 180 days iron (2.0-2.4 mg /100 gm) increases in hemoglobin level 11.68 % as well as BMI 7.16. Refinement of this study analysis that increases in hemoglobin level 11.68 % as well as BMI 7.16. Jaggery is a traditional sweetener prepared from sugarcane. Jaggery as a sweetener has useful nutritive components and is said to have various health benefits. Jaggery increases hemoglobin level because good source of iron.

Keywords – Value added Jaggery, Consumptions, Hemoglobin level

Effect of Bionanoconjugate of Indole Acetic Acid on Seed Germination in Cotton (*Gossypium hirsutum*L.)

Shiwani Mandhania¹, Vikram Singh^{1*}, Rashi Datten¹, Sonika Jakhar¹, A. Aravind Readdy¹

¹*Cotton Biochemistry Lab, Cotton section, Department of G&PB, CCS HAU, Hisar, Haryana, 125004.*

ABSTRACT

Cotton production substantiated a crucial part in the increasing economic development of many countries. To realize the increasing global demand for cotton, the importance should be laid on to improve cotton fiber growth and production. The modern cotton proved expedient in resolving inadequacies of conventional cotton, but still required improvements to encounter heightened demand of textile industries. One promising solution pertaining to this has been provided by nanoscience in the form of bio nanoconjugates. These bio nanoconjugates have efficient effect on cotton seeds germination by slow release of required component, and thus significantly influence several parameters relative to the growth and germination of cotton. Seeds of cotton were primed with bio nanoconjugates of indole acetic acid for 12 hours. After priming an improvement in the germination and germination related parameters was observed in cotton seedlings.

Keywords: Nanoconjugates, Indole acetic acid, Seed germination,

**Organic farming: A new paradigm for pest control in cucurbits
Sunidhi Pilonia*, Krishna Rolania, Surender Singh Yadav, Amit Kumar**

¹*Department of Entomology, CCS Haryana Agricultural University, Hisar, India*

ABSTRACT

In the pesticide-intensive agriculture, organic farming can be proved as a wonder in the rehabilitation of ecological equilibrium. Among vegetables, cucurbits are an important and economical source of nutrition where insect pests are one of the major constraints in cost-effective cultivation. Pest management primarily relies on chemical insecticides where the indiscriminate use has created a multitude of problems embracing pest resurgence, resistance, pesticide residues, secondary pest outbreak, destruction of beneficial fauna and environmental pollution. Under such debilitating circumstances, interest in organic farming has been growing as implementation of biological approaches, including biological control, bio-pesticides, bio-stimulants, botanicals and pheromones to control the insect pests, is generally safe for the environment and non-target species as well as a high priority for sustainable agriculture leaders and practitioners, including those working in Integrated Pest Management (IPM). For example, cue lure traps, neem-based products and predatory ants give excellent control of *Bactroceracucurbitaei.e.* one of major pest of cucurbits. Organic farming increases biodiversity of organisms with approximately 30% higher species richness than conventional farming systems. It leads to the bio-control of *Aulacophoraspp.* using predators *viz.*, soldier beetles, tachinid flies (*Celatoriadiabroticae*), braconid wasps, certain nematodes *etc.* in organic systems. The cucumber moth, *Diaphania indica* can also be effectively controlled using *Bacillus thuringiensis*, *Metarhiziumanisopliae*, *Beauveria bassiana* and neem based products. Furthermore, the increasing consumer demand and export market for pesticide free products encourage the large-scale growers to adopt organic farming.

Keywords: Organic farming, Biological control, Cucurbits, Integrated Pest Management.

**Response of Budload and Fertilizer on Berry Shape, Quality and Shot berry disorder in
Grapes cv. Sahebi**

Aroosa Khalil*, Nowsheen Nazir, Shaila Din, M.K. Sharma, Amit Kumar

¹*Division of Fruit Science, Sher-e-Kashmir University of Agricultural Sciences & Technology of Kashmir, Shalimar 190025, J and K*

ABSTRACT

Grapes occupy an important place among the fruit crops. However its productivity in Jammu and Kashmir state is low when compared to other major grape producing states. The main reason for this being the unscientific approach for grape pruning and inadequate supply of nutrients leading to reduced quality as well as quantity of the produce. Thus in order to give the proper recommendation of budload and fertilizers in grapes an experiment was conducted in model grapevine orchard of department of Horticulture at Krallbagh, Tehsil Lar, Ganderbal on 23-year old vines trained on bower system. The effect of these budload and nutrient level was assessed on the length: diameter ratio, number of seeds, TSS: Acid ratio and percentage of shot berries. The fertilizer treatment consisted of 3-levels of fertilizer doses (F₁=FYM 50 kg/vine + Recommended dose of NPK: 555, 227, 470g/vine, F₂=FYM 50 kg/vine+ 2 times recommended

3rd International Conference on “Global Initiative in Agricultural, Forestry and Applied Sciences for Food Security, Environmental Safety and Sustainable Development (GIAFAS-2021)”

dose of NPK: 1110, 454, 940g/vine, F₃=FYM 50 kg/vine+ 3 times recommended dose of NPK: 1665, 681, 1410g/vine). Three levels of bud load treatments were selected consisting of B₁: 96 buds/vine, B₂: 128 buds/ vine and B₃: 160 buds/vine. Treatments and their combinations were replicated thrice with a double plot size in a completely randomized block design. The results revealed no significant influence on berry L/D ratio and number of seeds/berry. However significant effect of bud load and fertilizer levels was seen on TSS/ acid ratio and percentage of shot berries. Budload B₂ indicated maximum TSS/acid ratio to the tune of 40.17 and 40.72 during both the years of study, whereas budload, B₃ recorded minimum TSS/acid ratio (27.03 and 28.15). Fertilizer dose F₂ recorded the highest TSS/ acid ratio (35.60 and 36.46). Considering the interaction effect, highest value of TSS/acidity ratio was noticed in B₂F₂ combination (43.37 and 42.85) during the two years respectively. The minimum percentage of shot berry (10.46 and 10.00%) was produced by budload, B₂ and maximum percentage of shot berry (18.86 and 17.83%) was noticed in budload, B₃. Percentage of shot berry was minimum (13.20 and 12.46%) by the application of fertilizer dose, F₂ and maximum (16.22 and 15.14%) by fertilizer dose, F₃. In case of interaction, percentage of shot berry was lowest in B₂F₂ combination (8.91 and 8.76%) followed non-significantly by B₂F₁ (10.50 and 9.92%) during the two years respectively.

Keywords: Shot berries, Budload, TSS/ Acid ratio.

Estimation of queen rearing techniques for quantitative queen characters in *Apis mellifera* Rajan Kamboj* and Surender Kumar Sharma

¹*Department of Entomology, CSK Himachal Pradesh Agricultural University, Palampur, India*

ABSTRACT

Honeybee conservation is currently a top issue globally due to a massive reduction in these vital organisms. The success in rearing honeybees is dependent on the adoption of the suitable recent management techniques for higher output in which queen replacement is an important factor for the colony performance. Therefore, present investigations were undertaken to assess the relevance and practical utilization of various methods of honeybee queen rearing in *Apis mellifera* during the year 2016-17 at CSKHPKV, Bee Research Station, NagrotaBagwan, HP. Queen cells were reared using strong mother and cell builder colonies two each with fixed 24 numbers of either eggs or larvae exposure. The highest number of finished queen cells and neonate queens were recorded as 9.00 ± 1.22 and 6.00 ± 0.91 in Doolittle method which was followed by Miller method (8.00 ± 1.08 cells and 4.25 ± 0.85 queens, respectively). The minimum mean duration of 18.75 ± 0.48 days to start laying was recorded by queens of Doolittle method while swarming queens took maximum period of 22.5 ± 0.87 days. The diameter at top of queen cells raised by Doolittle method had highest mean values (14.26 ± 0.61 mm). The mean size of queen cells was calculated (depth \times diameter at mid) and was found highest (25.86 ± 0.89 mm \times 12.11 ± 0.23 mm) by Doolittle method followed by Miller method (25.00 ± 0.33 mm \times 11.93 ± 0.44 mm). The least size of finished queen cells was found in swarming method (21.12 ± 0.24 mm \times 10.23 ± 0.75 mm). As per the studies, Doolittle queen rearing resulted in better quality queens and colony performance followed by Miller technique. It is worth recommending that to have quality queens Doolittle technique should be opted but due to enough expertise required; farmers cannot opt an easier and low cost Miller method in their apiaries.

Keywords: *Apis mellifera*, Queen rearing, Doolittle method, Miller method

A study on the performance of print media in popularization of new cultivation technology in Fenugreek at Neemuch District

P.S.Naruka, Shilpi Verma, S.S.Sarangdevot, C.P.Pachauri and J.P.Singh

¹*Krishi Vigyan Kendra, Neemuch*

ABSTRACT

Rural people are using social media for connecting with friends and family, reading current news, to get information from peers. Thus, connecting that to agriculture and leveraging it to bridge the farmer extension gap can prove to be a boon to the agriculture sector and the farm families. This study was carried out to assess the role of print media in the dissemination of fenugreek production technologies among the farmers of the district Neemuch (M.P). It was found that nearly 84.0% readability and 72% content was shared or forwarded by the respondents for dissemination of fenugreek production technologies. Significant number of farmers of Neemuch district (88.0%) consulted the printed material as extension guide about fenugreek production technologies, which was higher as compared to other study districts.

Study on the nesting behavior of *Apis cerana indica* F. feral colonies with respect to comb parameters

Dr. B. V. Shwetha, Mr. Bharath Kumar. A. K and Dr. K. S. Jagadish

¹Dept. of Apiculture, UAS, GKVK, Bangalore,

²Dept. of Apiculture, UAS, GKVK, Bangalore

³Dept. of Apiculture, UAS, GKVK, Bangalore

ABSTRACT

The feral colonies of Indian honey bee *Apis cerana indica* F. were analysed for studying their nesting behavior at University of Agricultural Sciences, GKVK, Bengaluru. The observations were recorded from five feral colonies on the comb area, brood area (both worker and drone), pollen and honey area both at colony and individual comb level. The mean values of comb area, brood area, pollen and honey area recorded were 283.662 cm², 5.4 cm², 0.092 cm², 102.55 cm² and 18.825 cm² per comb respectively. The mean total area per colony was found to be 2296.29 cm² with honey, pollen, worker and drone cell areas of 43.2 cm², 0.65 cm², 820.45 cm², 150.6 cm² respectively. It was observed that only 44.72 % of the comb area was utilized by the bees for brood rearing and storage of resources during dearth period.

Pigmented Rice and its Utilization in Food Industry

Faruk Ansari*, Devina Vaidya, Manisha Kaushal, Anshu Sharma, Sanjay Patidar, Priyanka Arya, Anupama Anad, Kavita Thakur, Ruchi Sharma, Harpreet Kaur Saini and Chahat Thakur

¹Department of Food Science and Technology, Dr. YS Parmar University of Horticulture and Forestry, Solan H.P. 173230

ABSTRACT

Rice (*Oryza sativa* L.) is one of the most important food crops in the world. The most common varieties belong to the white genotype, even then, there is an increasing interest for the pigmented varieties due to their huge antioxidant potential. The pigmented rice contains phenolic compounds especially anthocyanidins which act as colour pigment in form of glycosides. There are major two colors of pigmented rice; rice with reddish-grain color is commonly called red rice and white rice with a purplish grain color is called black rice. Pigmented rice is a good source of fiber, proteins, bioactive compounds and other micronutrients. For a long time, pigmented rice has been consumed mainly in China, Japan and Korea for strengthening kidney function, promoting blood circulation, treating anemia, diabetes and ameliorating sight. Major bioactive compounds in pigmented rice (red, black, purple & brown rice) are gallic, protocatechuic, hydroxybenzoic, p-coumaric, ferulic, sinapic acid, cyanidin-3-O-glucoside, peonidin-3-o-glucoside, flavan-3-ol, catechin, epicatechin, flavanols (flavan-3-ols), isoflavones, c-oryzanol contents, compositions of steryl, triterpene alcohol ferulates proportions and tocopherols, etc. These bioactive compounds have immense potential for various health benefits such as anti-tumor, anti-atherosclerosis, anti-diabetic, anti-allergic agents, alleviating gallstones and anti-inflammatory effects. Moreover, several anthocyanins in pigmented rice, including cyanidin 3-glucoside, cyanidin 3-galactoside, cyanidin 3-rutinoside, cyanidin 3,5-diglucoside, malvidin 3-galactoside, peonidin 3-glucoside and pelargonidin 3,5-diglucoside possess enormous functional properties in order to utilize them in functional food industry. The extracts from pigmented rice can be used as natural food colorants in bread, ice cream, liquor, extruded products as well as in many other functional foods. Also, as the problem of gluten intolerance is becoming very common, the currently used gluten-free foods made from purified starches or flour made up from pigmented rice could improve the nutritional value and functionality of these foods. Therefore, nutritional and functional properties of pigmented rice can be utilized for processing of value-added functional food products.

Keyword: Pigmented Rice, Protocatechuic, Hydroxybenzoic, Anthocyanidins

Development of process protocol for sugarcane juice

Priyanka Chauhan*, Manisha Kaushal, Devina Vaidya, Faruk Ansari

¹Department of Food Science and Technology, Dr. Y.S.P. UHF, Nauni, Solan HP

ABSTRACT

Sugarcane juice is very popular delicious drink and it is rarely available commercially in packaged form. It is extracted by crushing sugarcane between roller crusher and consumed with or without ice. It is high in nutritional value as it is rich in sugars, organic acid, vitamins, phenolic compounds, minerals etc. and possess excellent health benefits, but its processing and marketing are limited due to its rapid deterioration. The present study was conducted with objectives to

3rd International Conference on “Global Initiative in Agricultural, Forestry and Applied Sciences for Food Security, Environmental Safety and Sustainable Development (GIAFAS-2021)”

study the storage stability of sugarcane stalks, to develop the processing techniques for the extension of shelf life of sugarcane juice and thermally processed herbal sugarcane beverage. The sugarcane stalks were evaluated for storage under ambient (17-22°C, 45-52 % RH) and refrigerated conditions (4±1°C and 60-65 % RH). Study indicated that sugarcane stalks under refrigerated temperature can be stored successfully with minimum loss in weight (5.15%) and juice yield (12.12%) for four months as against one month under ambient conditions. Optimization of pH of sugarcane juice up to 4.00 was standardized by adding different acidulants where orthophosphoric acid was found highly acceptable on the basis of organoleptic characteristics. The standardized pH adjusted sugarcane juice was then heated at different temperatures (50°C, 60°C, 70°C, 80°C and 90°C) and results indicated that heating of juice at 90°C caused reduction in PPO activity (13.40±0.02 U/ml) as compared to control (51.60±0.02 U/ml). Time for pasteurization was optimized at 90°C for 15 minutes on the basis of PPO activity and microbial growth. The standardized protocol for the preservation of sugarcane juice involves pH adjusted juice (with orthophosphoric acid) preheated to 60°C followed by hot filling in pre-sterilized glass bottles and pasteurized at 90°C for 15 minutes. Study indicated that pH adjusted pasteurized sugarcane juice can be stored for three months under both the storage conditions with minimum changes in quality characteristics. Hence, it is concluded that the commercial adoption of this technology can be profitable for efficient storage and utilization of sugarcane juice and stalks.

Keywords: Acidulants, Orthophosphoric acid, Organoleptic, Ginger Extract, Mint Extract

Fruits and Vegetables Processing Waste Utilization in Food Packaging

Sanjay Patidar*, Devina Vaidya, Manisha Kaushal, Anshu Sharma, Faruk Ansari, Priyanka Arya, Anupama Anad, Ruchi Sharma, Harpreet Kaur Saini and Chahat Thakur

¹Department of Food Science and Technology Dr. YS Parmar University of Horticulture and Forestry, Solan H.P. 173230

ABSTRACT

Fruits and vegetables are widely used in different food processing industries and the utilization of their waste has become one of the main challengeable aspects in the world due to the generation of large quantity of by-products such as peel, seeds, unwanted portion, etc. The high amount of waste as a result of uncontrolled fermentation leads to environmental pollution by increasing biogas and uncontrolled release of methane. The annual quantity of fruit and vegetable residues has reached 40-50% globally, which includes a loss of approximately US\$ 680 billion in developed countries and US\$310 billion in developing countries. These processing wastes are rich source of carbohydrates, proteins, fatty acids, dietary fibre, minerals, vitamins, essential oils and other phytochemicals due to which they can be utilized by an alternative productive mean. Due to the worldwide problem of environmental pollution by petroleum-based plastics and large amount of food wastes or by-products from the processing industries, it has become matter of attention to find out more environment friendly substitutes of synthetic polymers. The development of sustainable bio-based food packaging system will ensure reduction of environmental impact and waste generation. In recent years the development of biodegradable packaging using biopolymer materials obtained from fruit and vegetable waste and utilization of these for the preparation of edible coatings and films, bio composite films, etc. have grasped attention of researchers and industries because of their eco-friendly, non-toxic, transparent and biodegradable nature unlike synthetic petro-plastic. Researchers also have extracted bioactive compound ability of these wastes in packaging because they act as carriers for inducing antimicrobial and antioxidant activity within active packaging system and also pH indication in intelligent packaging. For improving efficiency of these kinds of packaging, nano based materials such as nano chitosan, carrageenan and TiO₂ are being used to improve physico-chemical properties such as barrier against light and moisture, water vapor permeability, gas transfer rate and other mechanical attributes in the packaging film. Keeping in view above points, today's seminar will cover the aspects of utilization of fruit and vegetable wastes in food packaging.

Keyword: Waste Generation, Petroleum-Based Peel, Nano Chitosan and Carrageenan

ROLE OF PLASMA TECHNOLOGY IN FOOD

Kavita Thaku* and Faruk Ansari

¹Punjab Agricultural University, Ludhiana

²Dr. Y.S. Parmar University of Horticulture and Forestry, Solan

ABSTRACT

The need to improve microbiological food safety and quality without compromising nutritional, functional, or sensory properties of foods has sparked a surge in interest in cutting-edge food technologies. Plasma is a new, environmentally friendly processing technique that has a wide range of possible applications and meet an industry demand. Plasma

technology is founded on a simple fundamental principle: matter changes state when energy is supplied to it: solids become liquids, liquids become gaseous, and gases become ionised and enter the energy-rich plasma state, the fourth state of matter. Plasma can be generated by supplying energy through different sources (thermal, electric/magnetic fields, radio frequencies, and microwave). These techniques raise the thermodynamic energy of the electrons and improve particle collision, resulting in plasma formation. This method has shown promise in terms of preserving nutritional, functional, and sensory characteristics, as well as maintaining a fresh appearance. It aids in the structural alteration of food and packaging materials as well as microbial load management. Further, protein and starch modification to improve the functional and physico-chemical properties incorporation for food utilization.

Keywords: Plasma Technology, Energy Sources, Non Thermal and Modification

Growth Behavior and Productivity Status of Wheat under *Dalbergia sissoo* (Roxb.,) based Agri-silviculture System

Priya Jaiswal and Yashpal Singh

¹*Department of Forestry, JNKVV, Jabalpur, M.P.*

ABSTRACT

The present investigation entitled “Growth behavior and productivity status of wheat Under *Dalbergia sissoo* (Roxb.,) Based Agri-silviculture system.” were carried out during Rabi season of 2019-20 at the research form of Department of Forestry, College of Agriculture Jabalpur J.N.K.V.V (M.P). the present investigation was aimed to determine production potential of Wheat (JW-1215) under Agroforestry forming practices (Agri-silviculture) were conducted in RBD for different physiological parameter like Plant height , Number of tillers, spike length number of Fertile spikes Grain weight, Grain yield, Biological Yield, Harvesting index, and economics of this system,

It was observed that significantly higher field emergence was observed in in 30 DAS and 60 DAS and at harvest stage was Maximum plant height in Open condition (74.73 cm), Among pruning intensity reduction with pruning intensity (75%, 50%, 25%, and no pruning) (72.96 cm ,71.41cm, 70.31cm, 68.86 cm .) Number of tillers expressed the effect of treatment was significantly maximum in open condition (11.86) at par with 75% pruning intensities (11.12), and Test Weight Varietal variation recorded maximum in open condition (33.82 g) at par with 75% pruning intensities (31.26 g) spike length significantly higher was found in open condition (14.29 cm) at par with 75% pruning intensities (13.69 cm) similarly 37.95% Harvest Index were observed maximum in and 75% pruning intensities (37.12 cm) respectively and treatment variation shown significantly effect on grain yield (24.38 kg ha⁻¹) was found in open condition at par with 75% pruning intensities (23.17kg ha⁻¹) The result of the present study conducted that open condition was favorable for crop growth followed by 75 % pruning intensity. Grain yield, straw yield, biological yield and harvest index were significant highest in open condition at par with 75% pruning intensity .but highest obtain Gross monetary return and Net monetary return in 75% pruning intensity at par with 50%, 25% pruning intensity followed by open condition. Lowest significant recorded in No pruning intensity.

Key words: *Dalbergia sissoo*, Wheat, Yield, Silique, Harvest Index (H.I.), Economics

BIOFORTIFICATION OF RICE- A BRIEF OVERVIEW

Takhellambam Julia, Sushilkumar S., Rimamay K. and N. Sunita Devi

¹*Dept. of Genetics & Plant Breeding, College of Agriculture, Central Agricultural University, Imphal, Manipur, India. Pin: 795004.*

ABSTRACT

Our major food crops are poor sources of micronutrients required for normal human growth. Over two billion of the world's population is at the risk of micronutrient deficiency which resulted due to an inadequate supply of micronutrients in daily diet. The situation of continuous degrading natural resources, farm resource constraints, and agriculture affected by changing climate in the developing countries is making a rapid rise in micronutrient deficiency in food grains. Biofortification is a strategy that can overcome nutrient deficiency more sustainably. It is a one-time investment and offers a cost-effective, long-term, and sustainable approach in fighting hidden hunger because, once the biofortified crops are developed, there are no additional costs of buying the fortificants and adding them to the food supply during processing. Biofortification is a process of enriching the content of vitamins and minerals in crops through genetic and agronomic interventions. The majority of the Asian population prefers rice as their staple food. This milled and polished rice is a poor source of some minerals and proteins; therefore, it becomes a preferred crop for biofortification. Gregorio et al. screened improved cultivars, new plant type lines, local landraces, and lines from wild/related species for Fe and Zn content. It was reported that Fe (15.6 mg/kg) and Zn (378 mg/kg) content was higher in wild/related species. They also reported that an Indian floating rice local cultivar “Jalmagna” had 40% more Zn

3rd International Conference on “Global Initiative in Agricultural, Forestry and Applied Sciences for Food Security, Environmental Safety and Sustainable Development (GIAFAS-2021)”

concentration than the mega variety IR 64. An improved line (IR 68144-313-2-2-3) with high grain Fe concentration (21 ppm in brown rice) was developed by the International Rice Research Institute. This line was derived from a cross of IR 72 and “ZawaBonday,” a traditional variety from India. In 2015, Bangladesh Rice Research Institute (BARI) has released their third high-Zn rice variety “BRRI dhan 72” with the support of HarvestPlus. Two earlier varieties, viz., BRRI dhan 62 (2013) and BRRI dhan 64 (2014), were also enriched with Zn. The Indian Council of Agricultural Research (ICAR) has one of the mandates to improve the nutritional quality in high-yielding varieties of cereals, pulses, oilseeds, vegetables and fruit crops. In rice, India has released two biofortified varieties of rice, viz., “CR Dhan 310” having high protein content (10.3% in polished rice), which was developed by the National Rice Research Institute, Cuttack, and “DRR Dhan 45,” having high Zn content (22.6 ppm) in polished grain, developed by the Indian Institute of Rice Research, Hyderabad. Golden rice is a genetically modified provitamin-A(beta-carotene) enriched rice genome. Professor Ingo Potrycus and Dr. Peter Beyer considered as the founder of beta-carotene enriched golden rice. They used *cr1* gene from soil bacterium (*Agrobacterium tumefaciens*) and daffodil gene for modification of the genetic makeup.

Keywords: Biofortification, Micronutrients, Rice

Silver nanoparticles in dentistry: An emerging trend to combat oral diseases

Mohd Sajjad Ahmad Khan*

Department of Basic Sciences, Deanship of Preparatory Year and Supporting Studies, Imam Abdulrahman Bin Faisal University, P.O. Box 1982, Dammam 34212, Saudi Arabia

ABSTRACT

Oral diseases including caries and other implant associated diseases are continued to be a severe health burden globally. Designing of novel drugs against such disease requires understanding of mechanisms of disease using new studies and technologies. Oral diseases are caused by mixed population of bacteria and fungi and severity is further enhanced because of biofilm formation by these microorganisms on mucosal or dental implants. This results in persistent infections, increased drug-resistance, and immune tolerance. Recently, nanotechnology is gaining tremendous popularity due the increased effectiveness of nanoparticles in medical applications. The small size of nanoparticles provides greater surface to volume ratio as compared to non-nanoscale particles. Because of this exceptional feature, these materials are preferred choice to be used as fillers or modifiers in different products and materials. For centuries, silver has been exploited for medicinal values due to its antimicrobial properties. In recent times, silver nanoparticles have been synthesized as industrially engineered or microbial and plant derived by-products. Silver-based polymers can shield the inner and outer surfaces of devices like dental implants, catheters, prosthesis and endotracheal tubes against the colonization of microorganisms. Ag⁺ ions interfere cell permeability, electron transport, generation of reactive oxygen species and can cause DNA damage. Therefore, they are used in medical and dental applications viz. endodontic cement, dental restorative materials, silver based wound dressings, bone cements, in gels, lotions, and cosmetics. In the present review, we have discussed the current progresses made in the use of silver nanoparticles as antimicrobial polymers or biomaterials in dentistry. We have summarized various strategies being used to develop nanostructure complex of silver into polymer matrix or coatings for improved dental implants. Mechanisms of action of various silver forms such as elementary silver, silver zeolite and silver nanoparticles are described with reference to their anti-microbial and anti-biofilm potential for medical devices.

Keywords: *Anti-biofilm, biomaterial, dental implants, nanoparticles, silver*

Devil disaster of India: Floods and their blow on rural economy of India

Alongber Basumatary*, Sudhanand Prasad Lal, Biswajit Mallick and Srishti Paliwal

Department of Extension Education, Dr Rajendra Prasad Central Agricultural University Pusa, Samastipur- 848125, Bihar, India

ABSTRACT

Natural Disaster is an abnormally adverse event or phenomenon of a natural agent which leads to loss of life, property and food crisis. It captures headlines and national attention for the short term, but the work of recovery and rebuilding is long-term. Climate change has increased the temperature, leading to more frequent and more intense weather events around the world. A flood is a disaster that occurs due to an overflow of water that submerges land that is usually dry and is caused by heavy rainfall, storm surge, melting snow and ice, dams or levees breaking etc. About 90% of the damages caused by natural disasters (excluding droughts) are caused by floods and associated water flows thus the name Devil disaster. Flood damages properties, endangers humans and causes major economic losses. According to

3rd International Conference on “Global Initiative in Agricultural, Forestry and Applied Sciences for Food Security, Environmental Safety and Sustainable Development (GIAFAS-2021)”

UNESCO, the global average of economic losses caused by floods and droughts is more than US\$ 40 billion a year in all economic sectors. The floods are responsible for the death of almost twice the number of people than tornadoes and hurricanes put together. India has suffered a colossal crop loss on 18.176 million hectares (mha) of land, roughly 8.5 per cent of the total gross cropped area due to floods from 2017-2019. Floods cost India Rs. 4.7 lakh crore in the last 6 decades (DTE, 2020). Flood brings a plethora of diseases and is also a potential anthropic source of pollution, possibly inducing contamination of soil, surface water and groundwater. GoI has implemented several schemes and programs for the relief of flood victims. The Flood Management and Border Areas Programme (FMBAP) scheme for flood management works in the entire country. South Asia Flash Flood Guidance System (South Asia FFGS) was also launched on 23 October 2020 by the World Meteorological Organization. Radar estimates of rainfall and weather forecasting techniques are used for flood forecasting. The current study provides information and insights about the causal relationship between natural disasters and their impact on the economy of the affected areas. Climate change has increased the risk of such calamities and is likely to become more significant in the coming years.

Keywords: *Climate Change, Economy, Flood, Natural Disaster, UNESCO*

Income analysis of production and marketing of Potato (*Solanum tuberosum* L.) under different marketing channels

Vishwas Deep and Amita Girdhar*

Department of Business Management, College of Agriculture, CCSHAU, Hisar 125004

ABSTRACT

Potato (*Solanum tuberosum* L.) is the world's most important food crop which is always considered as the poor man's crop and known as the king of the vegetables. A greater proportion of potato is edible as compared to these staple crops and production is also higher per hectare, which, along with its nutritional value, emphasize its importance and describes ongoing expansion in potato production. It is cultivated in India for more than 300 years and is a wholesome rich source of carbohydrates, proteins, minerals, and vitamins. It contains 22.6, 1.6, 0.1, 0.4 per cent carbohydrates, proteins, fat, crude fiber, and 97 kcal. The present study was conducted in Kurukshetra and Yamuna Nagar districts of Haryana state. The results revealed that the cost of production of potato was observed Rs. 83820 per acre of land with an average production of 124.17 quintals of potato per acre. . The variable cost accounts for Rs. 45513.00 which was 54.29% of the total cost of production. Rental value of land and seed cost are the two major components of fixed costs in the total cost of production of potato covering about 43.20% of total cost of production. The gross income of the farmers was observed Rs. 155067.22 per acre in production of potato and net income was observed Rs. 71247.22 per acre of potato when farmer dispose their produce to the commission agents. The gross income of the farmers was observed Rs. 154180.64 per acre in production of potato and net income was observed Rs. 70360.64 per acre of potato when farmer dispose their produce to the wholesalers. The gross income of the farmers was observed Rs. 162662.70 per acre in production of potato and net income was observed Rs. 78842.70 per acre of potato when farmer dispose their produce to the retailers. The gross income of the farmers was observed Rs. 160888.31 per acre in production of potato and net income was observed Rs. 77068.31 per acre of potato when farmer dispose their produce to the super markets through contract marketing.

Keywords: *Production, Income, Farmer, Disposal, Contract farming*

The influence of groundwater desalination by bentonite / modified active carbon on its application in agriculture

Mohamed Eid Abdelhamid Elsayed

Soils, Water and Environmental Research Institute, Agriculture Research Center, El-Giza, Egypt

ABSTRACT

It can't be denied the importance of groundwater (Gw) as a source for irrigation; it is considered the only source for water in some locations, such as newly reclaimed lands. However, groundwater quality could be affected by salinity or heavy metals because of human activities or natural reasons. Thence, groundwater desalination comes to above as a part of the solution. In this study, the modified active carbon by inorganic iron polymer (Fex(OH)y (FeAC)) and bentonite (Ben) were used in groundwater desalination. The treatment process of two liters of groundwater was carried out by using a fixed-bed column where the flow rate was 120 ml/hour for each 20 grams sorbents. The results showed that the

EC value of groundwater (2.54 dS/m) was reduced to 1.12 dS/m for treated groundwater (TGw) by, FeAC / Ben. Furthermore, the effect of irrigation by Gw and TGw were tested on Faba bean. The vegetative characters were significantly affected by irrigation by saline Gw, while plant characters were much better after irrigation with TGw. As well, soil properties had been significantly affected by using TGw. Accordingly, treatment of groundwater by FeAC / Ben consider effective and an economic method can be applied before using saline groundwater.

Keywords: *Groundwater; Modified Activated carbon; bentonite; Faba bean*

Impact of rice residue management options and fertilizers on yield and yield attributes of rice (*Oryza sativa*)

Kavita¹, Dev Raj¹ and Kavinder²

¹*Department of Soil Science, CCS Haryana Agricultural University Hisar Haryana 125004.*

²*CCS Haryana Agricultural University Krishi Vigyan Kendra, Mahendergarh*

ABSTRACT

A field experiment was conducted at research farm, KVK, Panipat, CCS Haryana Agricultural University, Hisar during the 2018-19 and 2019-20 with the objective to study the impact of rice residue management options and fertilizer doses on yield and yield attributes of rice. The treatments applied were applied to wheat and their effects were studied on rice crop also. Treatment consist of four rice residue management practices (R₁: Residue removal, R₂: Residue Burning, R₃: Residue Incorporation and R₄: Residue Retention and direct seeding of wheat with happy seeder into standing rice stubbles) in main plot and different doses of NPK fertilizers (F₁: Control, F₂:100% N + 50% Recommended dose of P&K, F₃:100% N + 75% RD of P&K, F₄: 100% N 75% RDF+ Waste decomposer and F₅:100% Recommended dose of NPK fertilizer) in sub main plot. The grain and straw yield of rice follow the trend: Incorporation>Retention>Burning>Removal during 2018-19 and 2019-20, respectively. The growth, yield and yield attributes of rice (*viz.* plant height, test weight, number of tillers/row length, grains per spike) was observed significantly higher under residue incorporation and 100% NPK fertiliser doses treatment during both the years. Data also showed that both residue management as well as fertilizer level significantly affect the yield and yield attributes accept plant height during both the years. Only fertilizers level treatment having significant effect on plant height.

Keywords: *Rice, residue management, yield and yield attributes*

Management of soil fertility with incorporation of crop residues for sustainable cop production under Bundelkhand Agro-climatic zone

R.K. Prajapati, B.S. Kirar, U.S. Dhakad and I.D. Singh

Jawaharlal Nehru Krishi Vishwa Vidyalaya, Krishi Vigyan Kendra, Tikamgarh (M.P.) 472001

ABSTRACT

Tikamgarh district belong to Bundelkhand Ago-climatic zone of Madhya Pradesh which is rainfed area and due to extremely vulnerability in annual rainfall, topography, cropping system and traditional farming. All these realities were evidently showing that Bundelkhand is still facing the grave tragedy of drought. The soil like light, medium is the sharing 75% part which are not suitable for high value cropping as well as farming system due to low water and nutrients holding habits. The 75% farmers were under marginal, small which were not having agriculture implements and did traditional cultivation. National Innovations on Climate Resilient Agriculture (NICRA) was a network project. The project aims to enhance resilience of Indian agriculture to climate change and climate vulnerability through strategic research and technology demonstration. The KVK (Krishi Vigyan Kendra) Tikamgarh (M.P.) was implemented the NICRA project through adaptive village -Kanti of district- Tikamgarh which situated under Bundelkhand Agro-climatic zone of Madhya Pradesh. The farmers were not practicing crop residue management and balance use of manures and fertilizers on the basis of soil testing, therefore the soil fertility was extremely degrading and resulted to low yield in crop production while increased cost of cultivation. There was a need for resilient practice like incorporation of crop residues through deep summer ploughing, and stopping the crop straw burning. The demonstrations of resilient technological interventions were carried since 2011-12 to 2020 on soil testing based fertilizers and manures application, deep summer ploughing and stopped crop straw burning among 242 farmers in 483 ha under natural resource management modules of the project. The results were recorded increasing (%) in the infiltration rate of water in to soil (mm/hr), water holding capacity (mm/cm depth of soil), water use efficiency (kg/M⁻³) and organic matter (gm-carbon/ kg of soil) by 71%, 26.1%, 34.2 and 15.2 respectively. Reduction (%) were also observed in bio-stress like

3rd International Conference on “Global Initiative in Agricultural, Forestry and Applied Sciences for Food Security, Environmental Safety and Sustainable Development (GIAFAS-2021)”

insect-pests, diseases and weeds by 29.0, 19.2 and 88.5, respectively. The saving of time, money and labour were also enhanced due to improvement of soil physical properties and facilitation due reduction crop cultivation abiotic and biotic stresses. The farmers net income was increased by 15% (Rs 15000/ha/crop/season). Reduction (%) CO₂ and other GHGs emitted in atmosphere were due to stopped crop straw burning. The total wheat crop area was about 142 ha. Average wheat straw residue yield was 1 ton/acre when crop was harvested with harvesting machine. A ton of wheat straw contains (P₂O₅), (N) and (K₂O) about 13, 3.3 and 23 pounds respectively, thus a ton of straw saving contain \$14.93 worth of nutrients. (Rs.900/ton). (IPCC, 2000). The CO₂ (9.34 ton eq/ha), CH₄ (1.0 ton eq/ha) and N₂O (1.57 ton eq/ha) atmospheric pollutant were stopped to release in atmosphere by burning of wheat crop residues straw was estimated by (Bakker *et. al.*, 2010). The nutrient status of village during 2011-12 was like that organic carbon (0.33% Low), N (250 Low), P (27.0 Low), K (140-280 Medium) which changed after 10 years like that now organic carbon (0.76% High), N (405 High), P (37.3 Medium), K (398 High) due to managing of the crop residues as well as incorporation. The technologies were popularized by using of different method of extension activities through electronic and print media with convergence of district allied department. the farmers could have got more net profit from adoptions of these interventions even during extremely adverse climate, abiotic and biotic stress. The impact of deep summer ploughing and crop residues management were found suitable for Bundelkhand agro-climatic rainfed zone. The horizontally and vertically spreading in the district of these resilient technologies were also observed.

Keywords: *Soil fertility, Crop Residues, Natural Resources Management*

Enhancement in Crop Production through Hydrogel

Bhawani Singh Prajapat* and M. K. Kaushik

Department of Agronomy, Rajasthan College of Agriculture, Maharana Pratap University of Agriculture and Technology, Udaipur, Rajasthan 313 001

ABSTRACT

Twenty first century has witnessed a steady decline of irrigation water potential conjugated with the ever growing global population and enhanced economic activities among countries specially located in arid and semiarid regions of the world. As these regions are ever facing water crisis due to uncertain and inadequate natural precipitation, the problem with water scarcity may possibly aggravate further. It is estimated by 2025 water scarcity will be a major issue in India requiring immediate redressed. Due to the large geographical dimensions of the sub-continent, varied soil and farming practices, the modern irrigation practices can still only cater to 40% of the grown crops. The remaining areas are far more susceptible to improper practices thus greatly lowering the effective and judicious use of available water for crops. Hydrogel agriculture technology involves gel forming polymers that are insoluble water absorbing polymers designed exclusively for agricultural use by the late 1980's. Hydrogels as they are commonly called are cross-linked three-dimensional networked water absorbent polymers, improves the water holding capacity, water use efficiency, soil permeability and infiltration rate; and reduce the irrigation frequency, compaction tendency, soil erosion, farm run-off and surface leaching. During summer months particularly in semi arid regions, the lack of soil moisture can cause plant stress. Moisture released by hydrogel nearer to root area helps in reducing the stress and increasing the crop growth. In presence of water, it expands to around 200-800 times the original volume. There is ample possibility to trap irrigation and rainwater that can then be collected, stored and gradually released for crop requirements over prolonged durations. Hydrogel mixed with soil increase soil permeability and improve germination rates. It is compatible with a wide range and type of soils and thus has in general a tendency to increase crop growth and yield.

Keywords: *Hydrogel, Irrigation water, Productivity, Semiarid region, Stress*

Validation of Ovsynch and Heat Synch Protocol in Post Partum Anoestrus Cows

Dinesh Mahto

Krishi Vigyan Kendra (Jehanabad), Bihar Agricultural University, Sabour, Bhagalpur, Bihar: 804432 (India)

ABSTRACT

Thirty anoestrus post partum cross bred cows were randomly selected and equally divided into three groups. Animals were treatment with ovsynch and heat synch protocol in group I and II, respectively and groups III control groups mineral bolus, phosphorus injection and dewormer (Fenbendazole). The estrus induction group while the conception rate after insemination at induced estrus was 60% and 50% in group I & II, respectively as compared to control groups 20%. It is concluded that Ovsynch protocol along with mineral mixture supplement improvement the conception rate in post partum cows.

Keywords: *Ovsynch, heat synch, Anestrus, Post partum and cow*

Diversity And Community Structure Of Plant And Soil Nematodes Associated With Sugarcane (*Saccharum Officinarum*) From District Shamli (Uttar Pradesh)

Rashid Pervez* And Uma Rao

Division of Nematology, ICAR-Indian Agricultural Research Institute, New Delhi-110 012

ABSTRACT

Sugarcane (*Saccharum officinarum*) is the main source of the sugar in the world. India is one of the largest producer of sugarcane in the world. In India, Uttar Pradesh has the largest area almost 50% of the country, followed by Karnataka, Maharashtra, Tamil Nadu, Andhra Pradesh, Gujarat, Bihar, Haryana and Punjab. Survey and collected sixty three soil samples from the root zone of sugarcane from different localities of 5-9 villages of each thesil viz., Shamli, Unn and Kairana of district Shamli to know and also determine the present status of the diversity of soil and plant nematode fauna and to analyse nematode communities. Total 28 nematode genera have been encountered during present survey. Among them, fourteen belong to plant parasitic nematodes, eight were predatory nematodes and six belong to microbivorous nematodes. Data revealed that, *Pratylenchus thornei* and *Helicotylenchus* sp. were the most frequent and dominant species in the entire nematode community associated with sugarcane. Among the trophic groups, epidermal feeder was most frequent, whereas microbivorous group more abundant and prominent group in the community. This study indicated that a great diversity of nematode fauna are still unexplored and there is an urgent need to explore diversity of both beneficial as well as harmful nematodes in sugarcane ecosystem.

Keywords: Diversity, community analysis, nematodes, sugarcane, Shamli

Efficacy of pre and post-emergence herbicides on weed density, weed dry weight and growth and yield of direct seeded puddled wet rice under Cauvery command area of Karnataka Nagesh C. R. Sathisha C. and Vinutha B. B

ABSTRACT

A field experiment entitled “Efficacy of pre and post-emergence herbicides on weed density, weed dry weight and growth and yield of direct seeded puddled wet rice under Cauvery command area of Karnataka” was conducted during Kharif 2015 at Zonal Agricultural research station, V. C. Farm, Mandya, Karnataka. The experiment consisted of 13 treatments laid out in randomized complete block design with three replications consisting of two pre-emergence herbicides (pendimethalin and Pretilachlor + Bensulfuron methyl) and three post-emergence herbicides (Penoxsulam, Bispyribac sodium and Azimsulfuron) along with manual hand weeding. These herbicide treatments were compared with hand weeding and weedy check. The major weed flora observed in the experimental plot were, *Alternanthera sessalis*, *Eclipta alba*, *Monochoria vaginalis*, *Marsilia quadrifolia* and *Mollugo distica* among broad-leaved weeds; *Echinochloa colona*, *Echinochloa crusgalli* and *Leptochloa chinensis* among the grassy weeds and *Cyperus iria*, *Cyperus difformis* and *Flmbristylis miliaceae* among sedges. The results revealed that pre-emergence application of Pendimethalin 750 g a.i./ha at 3 DAS fb Penoxsulam (24 % SC) 22.5 g a.i./ha at 30 DAS, recorded significantly higher grain yield and straw yield (6328 and 7432 kg/ha), lower weed population and dry weight (9.20/m² and 3.70/m²)

Keywords: Direct seeded rice, Days after sowing, pendimethalin, penoxsulam

Diversity of Entomopathogenic Nematodes from Different Districts of Western Uttar Pradesh Rashid Pervez* and Uma Rao

Division of Nematology, ICAR-Indian Agricultural Research Institute, New Delhi-110 012

ABSTRACT

Entomopathogenic nematodes (EPNs) have great potential in reducing pest population and with little manipulation their role can be enhanced. To improve upon their biocontrol potential is to isolate native virulent EPN which can tolerate local climatic condition and in this way several biocontrol successes have been achieved in many parts of the world. Therefore, survey and collected 127 soil samples from different locations of Hapur, Meerut, Shamli, Saharanpur and Muzaffarnagar districts of western Uttar Pradesh, India for isolation of EPNs. Out of 127 soil samples baited out, only seven samples were found to be positive to entomopathogenic nematodes. Among these EPN

3rd International Conference on “Global Initiative in Agricultural, Forestry and Applied Sciences for Food Security, Environmental Safety and Sustainable Development (GIAFAS-2021)”

strains, three EPNs were found from Hapur district, two from Shamli district and one each from Saharanpur and Muzaffarnagar districts. Among seven isolated EPNs, three species belong to genus *Steinernema* and four to *Oscheius*. These EPNs have been characterized on the basis of morphometrics and morphological characterization. Our survey revealed that, *Oscheius* spp. and *Steinernema* spp. were widely occurred. Among the newly isolated *Steinernema* spp., one known species have been encountered, which characterized as *Steinernema cholashanense*. This species reported for the first time from the Hapur district. The information generated from present study may open the prospects for using EPNs in the biological control programs against insect pests in these areas because indigenous EPNs are adapted to the local environmental conditions and are natural regulators of insect populations.

Keywords: *Diversity, entomopathogenic nematodes, Uttar Pradesh, biological control*

Evaluation of different formulation of *Trichoderma viride* on seed germination, root length and shoot length of Bengal gram

Bhosale Rajeshri and Damayanti Guldekar

¹*SVGI College of Agriculture, Jalgaon jamod*

²*College of Agriculture, Nagpur*

ABSTRACT

The present investigation “Assessment of shelf life of *Trichoderma viride* on different liquid formulations” was conducted during the year 2016-2017 at Plant Pathology Section, College of Agriculture, Nagpur. The experiment was laid out in Completely Randomized Design (CRD) with 10 treatments and three replications. In paper towel method maximum germination percentage was in T₂ (paraffin oil) (84%) followed by T₆ treatment (82.33%). However shoot and root length was maximum in treatment T₂ (30.23 cm) and (22.2 cm) respectively. The maximum seedling vigour index was paraffin oil seed treatment.

Isolation, evaluation and characterization of disease suppressing Plant Growth Promoting Rhizobacteria (PGPR) of lentil rhizosphere

Niyaj Ahamad, Adesh Kumar, N.A. Khan

Dept. of Plant Molecular Biology & Genetic Engineering, A.N.D. University, Kumarganj, Ayodhya

ABSTRACT

A total number of 16 lentil rhizobacterial isolates were isolated at Nutrient Agar medium. Only twelve isoaltes showed antagonistic activity against *Fusarium oxysporum* f.sp. *lentil*. All the antagonistic isolates produced diffusible and volatile antifungal metabolites. The isolates 10 and 14 showed a maximum antagonism 72% and 68.6% respectively. All the antagonistic isolates showed PGPR activity such as phosphate solubilization, IAA production and ammonia production. On the basis of their antagonistic and PGPR traits out of nine only two isolates, 10 and 14 were found to be more effective which were selected for SDS-PAGE and 16S rDNA molecular analysis. Strain 10 and 14 identified as *Enterobacter ludwigii* and *Enterobacter cloacae*. The protein bands of variable size are present and both isolates have similar protein banding pattern. The PCR was run with primers namely, 16s Forward 5`GGATGAGCCHAGGCCTA3` and 16s Reverse Primer 5`CGGTGTGTACAAGGCCCGG3` PCR product was run on 1.5% agarose gel for appearance of banding patterns sequence of PCR product of 16S rDNA, the electropherogram and dendrogram generated which showed genetic similarity between the isolate 10 (*Enterobacter ludwigii*) and 14 (*Enterobacter cloacae*).

Keywords: *PGPR, Fusarium oxysporum f.sp. lentis, Antagonism, IAA, Phosphate solubilization, Ammonia production, 16S rDNA, Enterobacter*

Indigenous Versus Advanced Preparedness Strategies Adopted by Farmers in Cyclone Vulnerable Region of Odisha

Biswajit Mallick, Sudhanand Prasad Lal, Alongber Basumatary and Srishti Paliwal

PG Department of Extension Education, Dr Rajendra Prasad Central Agricultural University Pusa, Samastipur-848125, Bihar, India

ABSTRACT

3rd International Conference on “Global Initiative in Agricultural, Forestry and Applied Sciences for Food Security, Environmental Safety and Sustainable Development (GIAFAS-2021)”

India is one of the rare countries with both tropical and sub-tropical in North and South, respectively. It is vulnerable from low pressure to super cyclones at different time horizons. Catastrophe leads to significant damage of crops, loss of lives and livelihoods, and raise economic and social insecurities. Every year farmers are experiencing cyclones, which directly hit either the East or West coast of India. An analysis of IMD data unravels that among 295 cyclones, 262 landfalls over the East coast (92 of these were severe) and the rest 33 over the West coast (19 of these were severe) between 1891 and 1990. The state of Odisha is most affected compare to other East coast states (Tamil Nadu, Andhra Pradesh and West Bengal). The state witness around 6 severe to extremely severe cyclones in the first two decades of the 21st century. The current study gives insights into the various preparedness strategies and coping mechanisms used among the farmers to withstand cyclones. The assessment was based on secondary data sources. According to IMD disastrous weather events, annual reports from 1971 to 1999 total 24,885 people lost their lives wherein last 2 decade only 185 lost their lives due to awareness and preparedness before cyclones. People used to get information from radio or newspapers, but in the technology era, every one access real-time information through the internet, television, etc. Correct weather information help farmers to protect their pre as well as post harvested crops, livestock and houses, which were impossible before. After getting alert, people immediately move to nearby multipurpose cyclone shelters (MCS), and in the state, it is 316 in numbers. Now 24 hours weather data with radar animation live images from two stations (Gopalpur and Paradeep) is available to take accurate and immediate action against any natural disaster. The risk can be minimised through structural and non-structural interventions, rural mass empowerment, and advance awareness and planning strategy. As a result, strengthen managerial capacity, coordination, and networking facilities from grass root to higher authority levels improves preparedness, response, recovery, and mitigation of cyclones.

Keywords: *Coping Mechanism, Cyclone, MCS, Odisha, Preparedness Strategy, Vulnerable*

Studies on Diversity Of Edible Wild Mushrooms In Semarsot Wildlife Sanctuary, Chhattisgarh

***Bhavna Dixit and Reshma Ekka**

**Department of Forestry, Guru Ghasidas Central University, Bilaspur*

Department of Farm Forestry Sant Gahira Guru University, Sarguja Ambikapur,

ABSTRACT

The number of mushroom species documented in India is about 1,200, out of which 300–315 species are considered edible. The tropical forests of Semarsot provide favorable growth conditions for wild edible mushrooms. Extensive surveys and interviews conducted in the Semarsot sanctuary forest reveals 41 wild mushrooms in the forest area of sanctuary. Out of these 20 are edible wild mushrooms, most common of them are *Asteraus hygrometricus*, *Russula* spp. and *Termitomyces* spp.. 05 are medicinal of which *Ganoderma lucidium* is the important one, 02 fairly edible, 13 non edible and 01 poisonous Species of wild mushroom. Of these 20 edible wild mushrooms

Keywords: *Semarsot sanctuary, edible mushrooms, habitat*

Selenium nanoparticles stimulate growth and defence response in *Anabaena variabilis* under paraquat stress

Haleema Naaz & Tasneem Fatma

Cyanobacterial Biotechnology Lab, Department of Biosciences, Jamia Millia Islamia, New Delhi-110025

ABSTRACT

Increasing population has resulted in increased food demand. Pesticides like paraquat have been used indiscriminately to enhance the crop growth and yield. However, this has adversely affected a wide spectrum of non-target organism like cyanobacteria that are used as a bio-fertilizer in the rice field. In the present study, biogenic- *Gleocarpa gelatinosa* NCCU -430 mediated selenium nanoparticles (SeNPs) were synthesized and used as paraquat toxicity mitigator in cyanobacterial biofertilizer (*Anabaena variabilis* NCCU-442). Therefore, a comparative study was performed among control, PQ, SeNPs and SeNPs to check the efficacy of SeNPs in mitigation of PQ induced toxicity. Supplementation of SeNPs in PQ treated culture enhanced antioxidant enzymes activity i.e., SOD (7.55 %), CAT (57.94 %), APX (17.45 %) and GR (14.72 %). The findings of the present study suggested the role of SeNPs in ameliorating paraquat induced stress that may be used in sustainable rice cultivation needed for filling the gap between requirement and supply.

Keywords: *Selenium nanoparticles, Cyanobacteria, Paraquat, Toxicity, Oxidative stress, Anti-oxidant system.*

Effect of Monsoon Season On Different Stocking Density Of *Litopenaeus Vannamei* (Boone, 1931) Growth, Survival In Province Of Gujarat State In India

Kotiya A. S.^{1*} and Vadher K. H²

¹*Department of Aquaculture, Fisheries Research & Training Centre, Junagadh Agricultural University, Mahuva-364 290, India.*

²*Department of Aquaculture, College of Fisheries Science, Junagadh Agricultural University, Veraval-362 265, India.*

ABSTRACT

A season play an important role on the growth performance of any biological specimens like *Litopenaeus vannamei* collected from commercial pond Kavva Aqua Farm at Datardi village, Rajula (Gujarat). The experiment was taken up for 120 days with different stocking density of 30, 40, 50, 60, 70 and 80pc/m² with three replicate. The growth performance of Pacific White shrimp, *Litopenaeus vannamei* was recorded to observe the following attributes: stocking density, growth, survival rate, production and water quality parameters. The size of the culture pond was 0.50 ha. From the total ponds, 18 were taken up for experimental study. The SPF shrimp seeds were procured from MPEDA registered hatchery during the seasons. The initial average body weight of shrimp post larvae during summer crop at stocking was 0.06±0.04g. Mean growth during monsoon crop was significantly differ among the stocking densities with individual shrimp weights gain (g) of 34.46±0.24 followed by 31.2±0.31, 28.46±0.12, 25.89±0.35, 20.86±0.11 and 18.20±0.42 g and yields were 5091.6±57.6 followed by 6143.6±67.15, 7457.6±100.9, 7905.06±283.2, 7799.2±277.3 and 7292.6±165.1 kg/pond at 30, 40, 50, 60, 70 and 80 shrimp/m² respectively. Water parameter during the season was conducive and average water temperatures was 26.17±0.15°C. Better growth performance of shrimp was recorded in this season only because due to low water salinity, high dissolved oxygen content and suitable bloom and water quality. Larger shrimp size were associated with lower stocking density but higher yield was recorded at stocking density @60 shrimp/m² of raw shrimps biomass at harvest (kg) and good mean weight gain (g), low FCR, high ADG and SGR was recorded @30 shrimp/m². So it shows that aqua farmers during monsoon season should concentrate on what type of raw shrimp, they would like to produce from their culture pond like higher bulk production (kg) (stocked with 60pc/m²) with higher operational cost and uncertainty during culture activity or big count (g) (stocked with 30pc/m²) will give good return with low production cost and comfortable culture activity.

Keywords: *Shrimp, Stocking density, Growth, Monsoon and Production*

Biorational: New approach in plant protection

Vijay Laxmi Rai and Dharendra Pratap Singh

College of Agriculture Campus, Kotwa, Azamgarh-276001 A. N.D.U. A. & T. Ayodhya

ABSTRACT

Biological control of pests in agriculture is becoming more important due to the limitations for pest management related to ecological issues such as pollution, food contamination, and development of pest resistance. Biorational derived from a variety of biological sources including microbes as well as chemical analogues of naturally occurring biochemical such as pheromones and insect growth regulators (IGRs). They are considered as third generation pesticides with short residual activity and environmental safety. Biorational are classified into two distinct group- Biochemical and Microbial. In insect, behavioral messages are delivered by a wide array of chemical compounds. As a group, these compounds are known as semiochemicals. In some cases, they may facilitate communication between the members of a single species (pheromones) or between members of different species (allelochemicals). Among the new approaches for controlling agricultural insect-pest, is the development of novel compounds includes chitin synthesis inhibitors, juvenile hormone mimics and ecdysone agonists which adversely affect the specific developmental processes in insects. In addition, efforts have been made to develop compounds acting selectively on groups of insects by inhibiting or enhancing biochemical sites such as respiration, the nicotiny acetylcholine receptors, the GABA receptor, the salivary glands of sucking pests and others. Plant derived chemicals which originate from insect feeding and these elicit attraction from the natural enemies being specific indicators of insect density.

Keywords: *IGRs, microbial control, botanicals, semiochemicals*

Influence of Bio-Stimulants On Growth And Yield Of *Aggregatum* Onion *Var. Co 4*
Ragulraj, H., *Ramesh Kumar, A. and Srivignesh, S.

ABSTRACT

A field experiment was conducted to find out the effect of bio stimulants on growth and yield of aggregatum onion var. CO 4 during the year 2020-2021 in a village Olapatty, near Mallasamudam, Namakkal district, Tamil Nadu. The experiment was laid out in Randomised Complete Block Design with ten treatments and three replications viz., foliar spray of Humic acid 0.1% (T₁), Humic acid 0.2% (T₂), Humic acid 0.3% (T₃), Sea weed extract 0.1% (T₄), Sea weed extract 0.2% (T₅), Sea weed extract 0.3% (T₆), Fish Amino acid 0.1% (T₇), Fish Amino acid 0.15% (T₈), Fish Amino acid 0.2% (T₉) and control (T₁₀). Foliar spraying was done thrice at an interval of 15 days, starting from 30 days after dibbling of bulbs (30, 45 and 60 days after sowing of bulbs). Observations on growth and yield parameters were recorded at 45th and 60th day. Besides, physiological loss in weight (PLW) and rotting percentage were observed at post-harvest stage. The experimental results revealed that humic acid @ 0.3% recorded the dominant results of maximum plant height (41.30 cm), neck thickness (1.067cm) and dry matter (1.20g). The highest average bulb weight (33.25g), total yield (14.41 tonnes/ha) and Benefit: Cost Ratio (BCR) (3.44) was recorded in humic acid 0.3%. Sea weed extract at 0.3% recorded the next best results of plant height (38.30 cm), average weight of the bulb (29.00g) and bulb yield (12.57 t/ha), however, it performed better than fish amino acid and control. The overall performance of different bio stimulants vividly indicated that Humic acid @ 0.3% foliar spray is beneficial in increasing the various growth parameters of aggregatum onion var. CO 4 which resulted in higher yield coupled with enhanced post-harvest life. This would be due to the fact that humic acid treated plants might have exhibited better physiology in terms of respiration and photosynthetic activity, producing greater plant vigor and a great source for sink during bulbing. Similarly, Seaweed extract at low concentration produced more or less equivalent results. Auxin present in humic acid and seaweed extract would have triggered cell division that boosted the plant height and also promoted the root characteristics. Whereas the presence of cytokinin might be responsible for better yield characteristics in Sea Weed Extract. Fish amino acid resulted in better leaf growth and vegetative characters but it led to early maturity. The bulbs produced were unacceptable in case of size and colour. In post-harvest analysis, humic acid and seaweed extract provided good marketable bulbs with less rotting percentage compared to fish amino acid and control. Eventually, cost economic analysis indicated that foliar spray of humic acid and seaweed extract exhibited increased benefit: cost ratio, irrespective of their concentrations, besides, they are cost-wise cheap and affordable.

Keywords: Bio-stimulants, seaweed extract, humic acid, Fish amino acid, onion, yield, bulb, post-harvest

Major Problems Faced by Selected Dairy Farmers in Haryana State Manju Loura and Suman Ghalawat

Department of Business Management, CCS Haryana Agricultural University, Hisar

ABSTRACT

In India around 70 per cent of the population is dependent on agriculture and livestock rearing. In a rural economy dairy farming is normal adjunct to agriculture. India ranks first in milk production, accounting 22 percent of the total world milk during 2018-19 achieving an annual output of 187.7 million tonnes of milk, as compared to 176.3 million tonnes during 2017-18, recording a growth of 6.5 per cent over the previous year. Dairy Production helps the farmers in advancing their financial as well as social status. The current study was conducted in the dry region and wet region of Haryana, were denoted as Zone-I and Zone-II respectively in this study. Zone-I includes the districts of Kaithal and Karnal. Zone-II comprises of Sirsa and Hisar districts to analyze the constraints faced by the dairy farmers in Haryana state. The present study was carried out by personally interviewing 200 dairy farmers, by adopting multi stage stratified random sampling technique taken on five-point Likert scale, IBM SPSS-22 software was used for analysing the data by mean score percent. The findings of this study indicated that the major constraints faced by dairy farmers were production constraints, marketing constraints, financial constraints and other constraints like unavailability of skilled labor etc. With respect to production constraints, respondents perceived high cost of compound feed (57 %), lack of specialized dairy training (56.5%) and lack of knowledge about common contagious disease and their control measures (51.5%) as the most important constraint. With regard to financial constraints, the respondents reported that the high rate of interest (53%) was the most critical constraint followed by lengthy procedure for getting loan (63%) and inadequate land availability for fodder cultivation (30%). Poor marketing facilities (49%), lack of transportation facilities (32.5%), late payments received by producers (31.5%) and less remunerative prices of milk (20.5%) were the top 4 constraints under marketing constraints. With regard to other constraints, unavailability of skilled labor (53%) considered as the most important constraint by the farmers. The study revealed that among all the constraints, financial constraints is one of most important constraints and need to be focused more as majority of the respondents were facing problem regarding high rate of interest on dairy loans, dairy farming requires high initial investment hence dairy farmers needs

credits. New policies should be framed for credit availability in dairy sector, followed by unavailability of skilled labor, production constraints and marketing constraints. The study suggested that trainings and awareness programs may be formulated frequently to the dairy farmers in the area with which they are more concerned.

Keywords: Dairy Farmers, Constraints, Production constraints, marketing constraints, & financial constraints

Effect Of Micro Irrigation On Water Use Efficiency And Yield Of Bitter Gourd In Summer Season

Vinay Kumar, Uday Kumar Singh, Anil Kumar, Neena Bharti and Rupa Rani

Krishi Vigyan Kendra, Bokaro, BAU, Ranchi, Jharkhand

ABSTRACT

Field experiment was conducted to study the effect of water use efficiency and yield of micro irrigation systems in sandy loan soil. The experiment consisted of three treatments namely drip irrigation, pitcher irrigation and basin irrigation methods (farmer’s practice) for bitter gourd crop in 100m² plot size each with seven replication. For pitcher irrigation methods, earthen pitcher of 30 liter capacity. (4000 pitcher/ha) was taken. Four hole size 3mm diameter has been made at 1/4th height from bottom of the pitcher and Cotton thread was fixed was in the hole. The pitcher was buried 1/3rd of its height in the soil and placed between four plants of bitter gourd in the alternate row. For drip irrigation methods a tank having capacity of 200 liter and dripper discharge of 2 lit/hr. Size for each plant was taken. For surface irrigation method, basin size of 100m² was used. The result revealed that pitcher irrigation gave higher water use efficiency, yield and net profit in comparisons with drip and basin methods of irrigation in summer season of bitter gourd. Thus, it may be concluded that there was a considerable saving of water and increase in the yield of bitter gourd in case of pitcher irrigated crop as compared to drip surface irrigation.

Keywords: Micro irrigation water use efficiency pitcher irrigation

Priming: Seeds retain their germination overstretch

Guntha Adhithya

UAS, GKVK, Bangalore

ABSTRACT

Seed priming is a pre-germination treatment administered through various chemical, physical and biological agents, which induce mild stress during the early phases of germination. The versatility and realistic yield gains associated with seed priming and its connection with stress memory make a critical examination useful for the design of robust approaches for maximizing seed yield. The major signalling events for regulating early seed germination, including the DOG1, ABA, ABA-GA antagonism and nucleus-organelle communication. Highlight the potential for merging findings on seed priming with those of stress memory, with the dual benefit of advancing fundamental research and boosting crop productivity. Triple mutation in the PLY1, PLY4 and PLY6 ABA receptors, OsGS3, OsGW2 and OsGn1a triple mutants resulted in an approximately 30 % increase in seed yield in rice. Taken together, transgenic technology in combination with CRISPR/Cas9-based genome editing tools is likely to accelerate the development of new crop varieties. Priming treatments activate various enzymes like hydrolases, proteases, α -amylase and dehydrogenase, which facilitate endosperm weakening and stored reserve mobilization, to improve seed vigour and hormones, signalling mediators, transcription factors, defence genes/proteins during the early stages of seed germination. In addition, stress-responsive transcription factors, DNA repair proteins and metabolites like sugar, antioxidants and osmolytes are also up regulated, together contributing to the stress-tolerant phenotype of SPR-treated plants. DNA damage repair-related genes were up regulated in response to bio priming which improved seed germination and seedling establishment. Phase I is dominated by the activation of repair mechanisms to restore any dehydration-induced damage that took place during seed maturation. Phase II, wherein water uptake remains stable and the testa (seed coat) ruptures. During imbibition, ROS accumulate inside the seed, leading to carbonylation of storage proteins like cruciferin, and reserve mobilization. Phase III involves a rapid increase in water uptake, enabling cell elongation as well as DNA replication and cell division. As an adaptive mechanism, plants retain ‘memories’ of previously encountered stress that help them to confront impending stresses more rapidly and more efficiently. Multiple mechanisms, including chromatin remodelling, alternative transcript splicing, metabolite accumulation and autophagy have been used to explain somatic memory in

3rd International Conference on “Global Initiative in Agricultural, Forestry and Applied Sciences for Food Security, Environmental Safety and Sustainable Development (GIAFAS-2021)”

plants. During seed-to-seedling transition, the prevailing stress marks can be imprinted on the genome just as in stress-primed plants, leading to improved stress tolerance. Suggest that systematic screening should be performed to promote the cultivation of local varieties that respond best to seed priming, so as to maximize the cost benefit ratio for farmers. Seed priming and stress memory induce a ‘bet-hedging’ strategy in plants, they produce an overlapping phenotype, compromising plant growth under optimal conditions in lieu of better growth under stressful conditions. The molecular basis of stress memory is detailed at the level of chromatin reorganization, alternative transcript splicing, metabolite accumulation and autophagy. We argue that this could provide a framework to study similar mechanisms involved in seed priming. Integration of seed-priming and stress-memory-related research, identification of SPR-responsive varieties and development of dual/multiple benefit SPRs are proposed as a way forward for improving priming mediated agriculture.

Response of zinc sources on yield and quality of soybean (*Glycine max* L. Merrill) grown under acidic upland soil conditions of Nagaland

Sentimenla* and A. K. Singh¹

* KVK : Nagaland University, Lumami-798627, Nagaland, India

¹Department of Agricultural Chemistry and Soil Science, School of Agricultural Sciences and Rural Development, Nagaland University, Medziphema, Nagaland, India

ABSTRACT

A two years research on the effect of zinc sources on yield and yield attributes of soybean was conducted in two locations under the acidic upland soil conditions of Nagaland. Parameters such as seed and stover yield, protein and oil content were recorded at first, second year and pooled. The highest seed yield, stover, protein and oil content were recorded @ 5 kg ha⁻¹ ZnSO₄ H₂O + RDF (T₉) and the lowest was recorded in the control plot. From the experiment conducted for two years, it was observed that soybean responded well to application of zinc sources in balanced doses.

Keywords: Soybean, Seed, Stover, Oil, Protein, Zinc

Eminence Attributes Of Okra (*Abelmoschus Esculentus* L. Moench) Pods As Pretentious By Cultivar And Fruit Size

Tanu shiri^{1*}, Shailendra S. Gaurav¹, S.K. Singh² and S. Jain¹

¹Department of Genetics and Plant Breeding, C.C.S. University Campus, Meerut-250004, UP

²Department of Genetics and Plant Breeding, C.C.R. (PG) College, Muzaffarnagar-251001, UP

ABSTRACT

Okra is a vegetable widely grown in the tropics, sub-tropics and warmer areas of the temperate zones. Fruit quality plays an important role in marketability and it is mainly related to the characteristic pod length. This work was intended to classify okra fruits belonging to different genotypes according to their length and to compare certain quality attributes. Some genotype of okra fruits was considerably firm although they were smaller, thus they should be more suitable for canning or pickling. The hybrid material yielded high quality fruits. These fruits may be destined for fresh consumption, given that they showed lower fibrousness. At the same time, they had high dry matter content, being suitable for dehydration. Okra fruits highlighted for their contribution of phenolic compounds. Total phenols levels significantly increased with fruit size in okra fruits, meanwhile no significant difference was observed for some okra samples. Total flavonoids content showed a similar tendency although values did not differ significantly. Total flavonoids represented between 18-22% of the total phenols contents for the analyzed samples.

Keywords: Vegetables, phenols and flavonoids.

Effect of GA₃ and NAA on growth and physiological attributes of bishop’s weed (*Ammi majus* L.)

Aman Sobia Chishti^{1*}, Sarika Singh¹, Sangram Singh¹, Urooj Hassan Bhatt¹, M. Masroor A. Khan¹ and Moin Uddin²

¹Plant Physiology Section, Department of Botany, Faculty of Life sciences, Aligarh Muslim university, Aligarh -202002.

²Botany Section, Women’s College, AMU, Aligarh, India

ABSTRACT

Bishop's weed (*Ammi majus* L.), being a source of coumarins, flavonoids, alkaloids, and terpenoids, is medicinally important regarding various human ailments such leukoderma, psoriasis, kidney and gall-bladder problems, high blood pressure, depression, and allergic rhinitis. A net-house experiment was carried out to explore the effect of Gibberellic acid (GA₃) and Naphthalene acetic acid (NAA) on growth, physiological parameters, yield attributes, and active constituents of *Ammi majus*. Plant growth regulators (PGRs), viz. GA₃ (0, 50, 100, 200 and 400 ppm) and NAA (0, 25, 50, 100 and 200 ppm) were applied as foliar-spray treatments at 45 days after sowing. Application of both PGRs improved all the studied parameters. The best results were observed at 100 ppm of GA₃ and NAA and 50 ppm of NAA in terms of growth parameters (plant height, fresh- and dry-weight, and physiological parameters. The best values of yield attributes (number of umbels per plant, and seed yield per plant) were also recorded at 100 ppm of GA₃ and 50 ppm of NAA. The best values obtained due 100 ppm and 50 ppm of GA₃ and NAA, respectively, were significantly different from those obtained at control treatment.

Keywords: GA₃, NAA, growth parameters, yield parameters.

Impact of Farm Pond Technology on Economic Development of the Farmers in Palamu District of Jharkhand

Ashok Kumar Sinha¹, Rajiv Kumar², Ramesh Kumar³, Vinay Kumar⁴ and Sanjay Kr. Ram⁵

^{1,2,3,5} KVK, Palamu, BAU, Ranchi, Jharkhand, India

⁴ KVK, Bokaro, BAU, Ranchi, Jharkhand, India

ABSTRACT

The productivity of different crops becomes uncertain due to untimely setting of monsoons. The use of water harvesting and recycling of rainwater could improve the productivity of different crops by giving scope for supplemental irrigation at critical growth stages of the crop. The study was conducted in adopted villages of Murma and Dulsulma of Palamu district of Jharkhand under NICRA (National Initiative on Climate Resilient Agriculture) Project funded by ICAR. A few technologies were adopted in this project under different thematic areas like farm ponds under natural resource management. The study revealed that due to the availability of protective irrigation facility from farm pond the majority of *Kharif* and *Rabi* crops showed increase in average productivity. From the study conducted for the period from 2014-2020, it is proved beyond any doubt that the bold initiatives of NICRA such as farm pond technology helped the farmers in improving their economic status. By adopting farm pond technology, the selected farmers in the project area, the productivity, net income and economic status of the farmers have been increased.

Keywords: Climate Resilient Agriculture, Productivity, Protective Irrigation, Natural Resource Management, Farm pond Technology.

Fertility parameters' estimation of Kurnool soils using AVIRIS-NG hyperspectral reflectance data

Ali R.A. Moursy^{1*}, R.N. Sahoo², Nayan Ahmed³, Shalini Gakhar², and Bhabani P. Mondal²

¹Division of Soil and Water Sciences, Faculty of Agriculture, Sohag University, Egypt, 82524

²Division of Agricultural Physics, IARI, New Delhi, India, 110012

³Division of Soil Science and Agricultural Chemistry, IARI, New Delhi, India, 110012

ABSTRACT

The integration of Visible-Near-Infra-Red (Vis-NIR) hyperspectral data and multivariate regression models proved high efficiency for soil parameters' prediction. This study aimed to apply the Partial Linear Square Regression (PLSR) model for soil fertility assessment using Airborne Visible Infra-Red Imaging Spectrometer – Next Generation (AVIRIS-NG) hyperspectral reflectance data. Ninety-six surface soil samples were collected from fallow areas in Kurnool site, Andhra Pradesh, India at the same time of AVIRIS-NG hyperspectral data acquisition. Soil samples were prepared and analyzed for their fertility parameters. The corresponding hyperspectral reflectance data of soil samples were extracted from AVIRIS-NG mosaicked images then processed and used for developing soil prediction models using PLSR. The obtained results showed that soil parameters such as sand, pH, available K and available Fe were predicted using PLSR with a good performance. The correlation coefficient R² values of these parameters were 0.87, 0.66, 0.59 and 0.53, respectively; while Ratio of Performance Deviation (RPD) values were 2.66, 1.62, 1.49 and 1.49 for these parameters,

3rd International Conference on “Global Initiative in Agricultural, Forestry and Applied Sciences for Food Security, Environmental Safety and Sustainable Development (GIAFAS-2021)”

respectively. The rest soil parameters were having low predictability whereas $R^2 < 0.50$ and $RPD < 1.4$. The AVIRIS-NG hyperspectral data integrated with the PLSR model could successfully predict some soil parameters with a good performance. This technique is still empirical and needs more applications to be trusted as an alternative to conventional methods of soil analysis. Further studies can be done using AVIRIS-NG data for soil characterizing and mapping.

Keywords: AVIRIS-NG, PLSR, Kurnool, soil fertility

Vegetable Cultivation in Mizoram: Status, Sustainable Approaches and Future Scope

Saraswati Pandey¹ and Suryakant Choubey²

¹Dept. of Vegetable Science, ²Dept. of Agricultural Extension,

²College of Agriculture, IGKV, Raipur (C.G.) 492012

ABSTRACT

The vegetable crops have been well advocated in solving the problem of food security and balanced nutrition. They are rich source of minerals, vitamins, fibre (preferred by many health conscious consumers) and contain a fair amount of protein as well as carbohydrates. In addition to local market demand, vegetables have the potential for both domestic and export market. The vegetable production of our country before independence was merely 15 million tonnes and the same was about 162.96 million tonnes during 2013-14. The terrains of Lushai hills (Mizoram) are endowed with rich genetic bio-diversity of various vegetables (*Sechium edule*, *Cucurbita moschata*, *Benincasa hispida*, *Cucumis sativus*, *Momordica* spp., *Trichosanthes* spp., *Phaseolus vulgaris*, *Vigna unguiculata*, *Dolichus purpureous*, *Vigna umbellata*, *Parkia roxburghii*, *Psophocarpus tetragonolobus*, *Brassica juncea* var. *rugosa*, *Brassica oleracea* var. *alboglabra*, *Cyphomandra betacea*, *Zingiber officinale*, *Curcuma* spp., *Colocasia* spp., *Solanum melongena*, *Solanum gilo*, *Solanum macrocarpon*, *Capsicum annum*, *Capsicum frutescens* and *Capsicum chinense*) which could be used to improve yield potential, quality and tolerance to stresses. Moreover, the use of hybrids/ high yielding varieties, access to knowledge and technologies, interactive demonstrations, better input delivery systems, good communication, and proper utilization of available resources would be very useful in enhancing the vegetables' productivity, and ensuring the food and nutritional security to the tribal community. Over the years, the tribal farming communities have been using many indigenous technologies to fulfill their vegetable requirements by utilizing the available resources from jhum lands. They were depending entirely on locally available input resources and knowledge base for maintaining the productivity. Therefore, strategies formulated for meeting the demand and need of vegetable production, the planners should address two major issues: firstly, a sustainable vegetable production plan and secondly, livelihood enhancement opportunities. Hence, the segments which require immediate steps are: Introduction of high yielding varieties and hybrids, Plant population and crop geometry, Integrated water management, Integrated nutrient management (INM), Integrated pest management (IPM), Hi-tech horticulture, On-farm trials (OFTs)/ front-line demonstrations (FLDs) and Post-harvest management and processing. Mizoram is one of the least users of inorganic fertilizers (80.9 kg NPK/ ha/ annum) and chemical pesticides, and the produce is almost organic in nature. Searching the markets for chow-chow, chilli, ginger, turmeric, etc. especially in Metro cities, and developed and economically sound countries would help in getting assured markets and good prices which will eventually help in strengthening the farming communities. The Lushai hill is blessed with rich bio-diversity of many vegetables. In the era of Plant Variety and Farmers' Right Act; collection, characterization and conservation of available gene pools would provide royalty to farming community for commercial utilization of their specific genetic resources. The utilization of available genetic resources will also assure the high productivity and well adaptability of developed varieties/ hybrids.

Keywords: vegetables, biodiversity, Mizoram, organic.

Success Stories on Empowering Farmers Through Horticultural Technologies In Dehradun Region Of Uttarakhand

S.S. Singh*

G.B. Pant University of Agriculture and Technology, Krishi Vigyan Kendra, Dehradun, Uttarakhand

ABSTRACT

Horticultural crops provide nutritional security and have great potential to enhance the socio economic condition of the farmers. The prevailing agroclimatic condition, varied topography, small and fragmented land holdings in the State of Uttarakhand provide ample opportunity for commercialization of horticulture sector. From the last two decades

3rd International Conference on “Global Initiative in Agricultural, Forestry and Applied Sciences for Food Security, Environmental Safety and Sustainable Development (GIAFAS-2021)”

considerable progress has been made after the introduction of various programmes and schemes of Govt. of India and State government. Farmers are also getting comparatively more return from horticultural crops due to which area and production both are increasing rapidly. Public and private sectors started realizing that proper development of horticulture based farming can ensure the livelihood security of the farming community in the State. In this context, Krishi Vigyan Kendra, Dehradun, Uttarakhand has taken several initiatives since its establishment in December, 2004 in empowering farmers about the horticultural technologies whose brief summary are as follow :-

Effective Dissemination of Pick Bag Technology through Media Form

Nisha Arya and Nirmala Yadav

Department of Textile and Apparel Designing, IC College of Home Science, CCS Haryana Agricultural University, Hisar

ABSTRACT

Traditionally, picking and collection of agricultural output has been a tedious job performed especially by women in the fields for long working hours. Understanding the amount of labour and pain involved; pick bag technology for different activities such as Cotton picking, Pearl millet ear head collection, Pick bag cum *Gathri* and Vegetable collection was developed in order to significantly increase the output (collection) and reduce the drudgery. It being highly acceptable and user friendly technology, needs to be disseminated at wider scale to reach masses in the rural areas through effective media form. Hence, for effective use of developed technology and to get required results, media package in the form of print & CD ROM was developed that will serve as a platform for effective dissemination of the developed pick bag technology. Media package on pick bag technology included: cutting, stitching of pick bag; modification as per body size; its use for multipurpose activities; use of ready paper patterns; use of discarded material for pick bag preparation. The thrust of work while developing media package was on imparting technical knowhow about pick bag technology to help rural women in undertaking it as an entrepreneurial activity for income generation. Being interactive it can be used number of times as per the need, time and learning potential of the user. The developed print and electronic media was found to be very helpful in awareness generation, motivation, knowledge and skill development of the beneficiaries. It is considered as economical as well as time saving mode of dissemination of technology.

Keywords: *drudgery, media package, technology, dissemination, picking*

Effect on India Agriculture Due to Climate Change

Shishir Kumar Kaushal¹, Ekta Sharma², Dr. Ratnakiran Wankhade³ and Hemant Kumar Singh

^{1,2,4}Department of Applied science and Humanities, Feroze Gandhi Institute of Engineering and Technology, Raebareli, Uttar Pradesh -229001

Department of Farm Machinery and Power Engineering, G. B Pant University, Pantnagar, Uttarakhand

ABSTRACT

Climate change has a serious impact on the availability of various resources on the earth especially water, which sustains life on this planet. Changes in the biosphere, biodiversity and natural resources are adversely affecting human health and quality of life. Throughout the 21st century, India is projected to experience warming above global level. India will also begin to experience more seasonal variation in temperature with more warming in the winters than summers. Longevity of heat waves across India has extended in recent years with warmer night temperatures and hotter days, and this trend is expected to continue. The average temperature change is predicted to be 2.33°C-4.78°C with a doubling in CO₂ concentrations. These heat waves will lead to increased variability in summer monsoon precipitation, which will result in drastic effects on the agriculture sector in India. Climate models predict a gradual rise in carbon dioxide (CO₂) concentration and temperature across the globe. These models, however, are not very precise in predicting future changes in local weather conditions. Local weather conditions such as rain, temperature, sunshine and wind, in combination with locally adapted plant varieties, cropping systems, and soil conditions can maximize food production as long as plant diseases can be controlled. Global climate change is a change in the long-term weather patterns that characterize the regions of the world. The term "weather" refers to the short-term (daily) changes in temperature, wind, and/or precipitation of a region. In the long run, the climatic change could affect agriculture in several ways such as quantity and quality of crops in terms of productivity, growth rates, photosynthesis and transpiration rates, moisture availability etc. Climate change is likely to directly impact food production across the globe. Increase in the mean seasonal temperature can reduce the duration of many crops and hence reduce the yield. In areas where temperatures are already close to the physiological maxima for crops, warming will impact yields more

3rd International Conference on “Global Initiative in Agricultural, Forestry and Applied Sciences for Food Security, Environmental Safety and Sustainable Development (GIAFAS-2021)”

immediately. Drivers of climate change through alterations in atmospheric composition can also influence food production directly by its impacts on plant physiology. The consequences of agriculture’s contribution to climate change, and of climate change’s negative impact on agriculture, are severe which is projected to have a great impact on food production and may threaten the food security and hence, require special agricultural measures to combat with.

Keywords: *Agriculture productivity, Climate change, Greenhouse Effect, Global Warming*

Factors Influencing the Use of Vermicompost among Farmers in Sirsa District, Haryana Megha Goyal¹, Sagar Mehta² and Nitin Kumar³

¹*Department of Business Management, CCS Haryana Agricultural University, Hisar, India.*

²*Department of Business Management, CCS Haryana Agricultural University, Hisar, India.*

³*Kurukshetra university Kurukshetra.*

ABSTRACT

With the heavy use of fertilizers, the fertile lands were affected and as a result humans were immensely affected. Moreover, on the other side, municipal solid waste increased tremendously affecting the environment. In this context, vermicomposting which not only encourages efficient recycling of biomass but also generates income and employment for the rural poor is being promoted as a prudent option. *The present paper studied* the factors influencing farmers for using vermicompost in Sirsa Dist. (Haryana). A survey has been conducted on 50 farmers by using questionnaire as research instrument. Demographic profile has been analysed using Pie-charts and bar diagrams have been used for finding the factors influencing the quality and uses of vermicompost. The validity & reliability of a questionnaire has been tested using Cronbach’s alpha method. The factor analysis with twelve observed variables (i.e., survey question responses) that can be summarized in terms of three factors with Cronbach alpha values .845, .836 & .674. Cronbach alpha for all the factors is greater than 0.6, hence questionnaire is reliable and strength of factor 1 is more with higher value of Cronbach alpha. It is concluded that food safety, better plant quality, environment friendly, easy to handle, high yield, dose and cost are effective variables with high factor loading. Vermicomposting technology is highly beneficial and helps in improving the economic status of the manufacturers and farmers.

Keywords: *Vermicompost, Fertilizers, Reliability, Factor Analysis, Cronbach Alpha.*

Studies on resistance to *in-situ* germination in inter-specific derivatives of mung bean (*V. radiata* × *V. radiata* var. *sublobata*)

R.A. Jadhav¹, S.P. Mehtre², D.K. Patil³ and V.K. Gite⁴

Department of Agricultural Botany, College of Agriculture, Vasant Rao Naik Marathwada Krishi Vidyapeeth, Parbhani-431402 (Maharashtra)

ABSTRACT

Mung bean crop is very susceptible for *in-situ* germination. The material for present study included 65 breeding lines including derivatives of three way, four way and single crosses along with cultivated checks. The data of observation on *in-situ* germination were recorded at interval of 5 days, 10 days, 15 days, 25 days and 35 days both in field and laboratory conditions for two seasons. For this investigation, representative sample of ten inter-specific derivatives along with parents were selected which were found dormant for shorter period. The results of biochemical analysis showed that presence of phenolic compounds in breeding lines and it ranged from 7.2 µg/gm to 28.2 µg/gm. Phenolic compounds containing in cultivated species is recorded <10 µg/gm of sample i.e. between 7.8 µg/gm - 9.1 µg/gm. Whereas, the wild donor for dormancy trait i.e. BWM-29 recorded highest quantity i.e. 28.2 µg/gm of phenolic compound. Inter-specific derivatives namely, SPS-6-39-21, SPS-6-52-6, SPS-42-1-11-1, SPS-42-1-11-2, SPS-6-23-6 and SPS-10 recorded phenolic compounds between 12-17 µg/gm. This indicates that, inter-specific derivatives containing high quantity of phenolic compounds (>10 µg/gm) may be responsible to induce the seed dormancy for a period of one month. The cultivated species containing very less quantity of phenolic compounds have low effect on seed dormancy. The inter-specific derivatives contain genome of partly donor (BWM-29) and partly cultivated (BM-4) containing a medium quantity of phenolic compounds which may be responsible to induce the dormancy for shorter period.

Keywords: *Mung bean, in-situ germination, Phenolic compounds.*

Forest Fire: An Changes The Environmental Condition

Harischadra Darro¹ and Rajesh Kumar²

¹*Department of Forestry, Indira Gandhi Krishi Vishwavidyalaya, Raipur .Chhattisgarh, India*

²*Department of Forestry, Wildlife & Environmental Science, Guru Ghasidas (A Central University) Vishwavidyalaya, Bilaspur, Chhattisgarh, India*

ABSTRACT

At present time forest fire is a major issue around the globe. The world faces the year extreme forest fire that damages a million hectares of forest cover area and mostly affects the ecosystem, biodiversity, and landscape stability. Fire has damaged all over the forest area and reduces the forest cover area in the world. Many organizations consider the forest fire has been an unplanned and unwanted fire, but mostly, forest fire causes anthropogenic activity, which damages invaluable plants and animals and sometimes involves in villages. Forest fire emits a large number of trace gasses and particle, these gasses emissions are significant changes the chemical properties of the atmosphere and earth ecological system. Fire emitted gases may be involved in carbon dioxide, carbon monoxide, methane, nitrous oxide, nitrogen oxides, non-methane volatile organic carbon, fine and coarse particle matter, and some other gasses. These gasses mostly primarily influence the environment and greenhouse emission and secondary influence the ozone formation and albedo effect. They are releasing the aerosol into the atmosphere, which complex affects the cooling and warming of the environment. Fire emitted gasses or particle major contribution of increase the air pollution in the atmosphere and degrade the visibility in a particular area.

Keywords: *Forest fires, Fire effect, Ecology, Environment*

Assessment of Improved Production Practices on Fibre Yield and Quality of Jute in Murshidabad district of West Bengal

Amrita Kumar Sarkar*, Sudhanand Prasad Lal and Dasikonda Sangeeth

PG Department of Extension Education, Dr Rajendra Prasad Central Agricultural University, Pusa, Samastipur, Bihar-848125, India

ABSTRACT

The study had been carried out in Murshidabad district of West Bengal state to assess the sustainability of the improved technologies and the involved return on investment towards improving yield and quality of jute fibre. The state was selected purposively as it was placed first in all three- production, acreage, and productivity of jute among the other states in India. In the case of the district also, the purposive selection was followed. Two blocks were chosen randomly, and a total of four villages, two from each block was selected randomly. A total of 120 respondents taking 30 from each village, were chosen for the personal interview. The index was developed following Alfares & Duffuaa (2009) and Sullivan *et al.* (2006) method. Data were collected by direct observation, personal interview and focus group discussion (FGD) method with the help of a structured interview schedule prepared for the study. A total of 6 improved practice indicators of jute cultivation was taken under consideration. Besides, the constraints faced by the farmers in adopting the improved practices were also identified and prioritized. Statistical analyses were performed by computer-based research randomizer, linear regression, BCA, Garrett ranking method (1979), etc. Several charts such as colour-coded stratified radar chart, comparative spider chart, share and breakdown pie chart, and multilevel pie chart had been developed. The results revealed that the respondent farmers had a low adoption level in the overall improved practice index (IJPP index value= 0.223). The farmers unraveled that out of 6 indicators, fibre extraction and retting had the maximum weightage (96.84), followed by weeding (88.93) and seed and sowing (81.02) indicators. The regression analysis showed that education, risk orientation, and innovation propensity were significant at 10%, and contact with cosmopolite channels was significant at a 5% level. The B:C ratio over Cost C₂ and Cost B₁ for improved practices was 40.42% and 51.98% higher than traditional practices. Consequently, if the yield can be optimized through introducing the improved cultivation practices, then doubling the farmers' income will not be a distant dream.

Keywords: *BCA, Computer-based research randomizer, Constraints, IJPP, Yield and quality of jute fibre.*

Pradhan Mantri Ujjwala Yojana: An Overview of Phase 1 & Phase 2

Srishti Paliwal^{*}, Ashok Kumar Singh, Biswajit Mallick, Alongber Basumatary and S.P.Lal

PG Department of Extension Education, Dr Rajendra Prasad Central Agricultural University Pusa, Samastipur-848125, Bihar, India

ABSTRACT

In rural India, cooking with dung cake or firewood has been a leading cause of respiratory ailments among women. One tonne of cow dung burning releases 1101 Kg of CO₂-C, while one time cooking emits smoke equivalent to 200 cigarettes. Firewood obtained from neighbouring forests or dung cake prepared by women are viewed as zero-cost alternatives. Because of these practices and the lack of a better alternative, rural women have been exposed to noxious fumes and the health risks that come with them. These activities also affect global warming and air pollution as they emit collectively significant amount of smoke and carbon dioxide. To address this problem, on May 1, 2016, the Honourable Prime Minister launched the PM UjjwalaYojana in Ballia, Uttar Pradesh, with the goal of making clean cooking fuel such as LPG available to rural and deprived households who were previously reliant on traditional cooking fuels such as firewood, coal, and cow-dung cakes. The traditional cooking system had detrimental impacts on the health of rural women as well as on the environment. The main objective of scheme was to provide 8 million LPG connections to low-income families by March 2020. The Honourable Prime Minister of India handed over the 8th Crore LPG connection at Aurangabad, Maharashtra, on September 7, 2019. Up to August 22nd 2021, a total of 80,699,686 connections were issued and a total of 63,92,482 connections were released in Rajasthan. PM Ujjwala 2.0 is an extended version of PM Ujjwala which was launched from from Mahoba, Uttar Pradesh on 10th August, 2021. The government plans to deliver roughly 1 crore gas connections to the poor this fiscal year (2021-22), along with a free refill and a gas stove with 704,664 connections released up to 22nd August 2021 under Ujjwala 2.0. However, the refilling has remained poor ranging from 26-70% across different states. So, RPCAU come up with a unique SUKHET model to barter the cow dung with a cooking gas cylinder with a slogan “Gobar deebo, gas leebo” that also received exceptional citation in PM Mann Ki Baat Programme in 80th Edition on 29th August 2021.

Keywords: *Air pollution, Cow dung, Global warming, LPG connections, Ujjwala yojana*

Impact Assessment of PM-KISAN Yojana: its lacunas & corrective measures

Rishabh S. Gaur^{*}, Karunesh Verma, Biswajit Mallick and Sudhanand Prasad Lal

PG Department of Extension Education, Dr Rajendra Prasad Central Agricultural University Pusa, Samastipur-848125, Bihar, India

ABSTRACT

At present, Indian agriculture is facing a deep crisis and farmers’ distress and suicides have risen sharply since the early 1990s. For coping up with this devastated situation government reformed various policies and schemes for the welfare of farmers. ‘PM-KISAN Samman Nidhi’ is one amongst them. PM Kisan is a Central sector scheme with 100% funding from Government of India. It became operational since 1st December 2018 from Gorakhpur district of UP. Under the scheme an income support of Rs. 6,000/- per year in 3 equal installments will be provided to small and marginal farmer families having combined land holding/ownership of upto 2 hectares. According to the current report of NIC (National Informatics Centre) there are about 11, 53, 39,333 number of beneficiaries. Out of which the leading beneficiaries are from the state of Uttar Pradesh which is 2,59,04,388. But after computing the beneficiaries one can come across the data from secondary sources and can found that there are some of the minor lacunas which relatively reduce the effectiveness of this scheme. Firstly, there is an absence of proper source of information for the farmers to get resourceful knowledge about this scheme. Secondly, this scheme leaves unanswered questions like, if beneficiary farmers wish to lease their lands to tenant farmers or keep their lands fallow for some time, are they eligible to receive cash benefits? Who will be accountable to check the opportunistic behavior of some farmers? Except a few states, others are still lagging in maintaining database for land records. Beside these lacunas there some of the cons viz., farmers are usually illiterate and it creates gap in the real information and their actual interpretation about the scheme guidelines. Difficult procedure of filling form is another cons. of this scheme. Failure in efficacious use of money by farmers given under this scheme as they sometimes spend this money in some non-agricultural activities. After having a close insight about this scheme, some of the measures which should be taken to achieve proficient use of this scheme. First of all there should be an inclusion of the informatory video with proper description about the scheme in the official portal of PM-KISAN.

3rd International Conference on “Global Initiative in Agricultural, Forestry and Applied Sciences for Food Security, Environmental Safety and Sustainable Development (GIAFAS-2021)”

Government should focus on the consistent use of e-RUPI Scheme for proper utilization of installments. Agriculture is a state subject & the Centre should create an enabling environment through responsive bureaucracy legal compliance, easing of doing business, market infrastructure, and trade facilitation. Government must realize that its goal should be to reduce poverty, ensure sustainable food security, and inclusive growth and wellbeing of farmers.

Keywords: Agriculture, Beneficiaries, Installments, Lacuna, PM-KISAN, Scheme.

Adoption Of High Density Apple (*Malus Domestica*) Plantation And Its Economic Impacts On Rural Livelihood Of Darchula District, Nepal

Binod Pokhrel^{1*}, Suman Bhattarai² and Ankit Ojha³

¹Department of Agriculture, Agriculture and Forestry University, Chitwan, Nepal

²Department of Agricultural Economics, Institute of Agriculture and Animal Science, Tribhuvan University, Kathmandu, Nepal

³Department of Genetics and Plant Breeding, Agriculture and Forestry University, Chitwan, Nepal

ABSTRACT

This study was conducted to assess the economic benefits and identify production as well as marketing constraints of high density apple production in Darchula, one of the most remote districts in far-western region of Nepal. The information was primarily collected from 60 apple growers from two locations, Byas and Api-himal rural municipality by simple random sampling technique. Interview using semi-structured questionnaire schedule was carried out for the collection of primary data. Data analysis involving chi-square test and independent sample t-test was done using MS-Excel and SPSS. Qualitative techniques were used to analyze yield, establishment cost and Benefit Cost ratio. Apple growers were categorized into small and large farmers based on area of high density apple plantation. Farmers perceived that adoption of high density plantation was emphasized due to small land holding and high return per unit of land. The average area of land of large farmers (1.93 ha) was significantly higher ($p < 0.01$) than that of small farmers (0.75 ha) for apple cultivation and the overall average area of land was 1.13 ha. Average establishment cost was NRs. 733585.47 per hectare. Majority of the farms (33%) had spacing of 2m×2m that can accommodate 2500 trees/ha having higher number of productive plants as well as higher yield followed by 3m×3m (1111 trees/ha). Average productivity of large farmers (12.73 Mt/ha) was significantly higher ($p < 0.01$) than that of small farmers (8.088 Mt/ha). Economic analysis of high density apple plantation revealed the mean benefit cost ratio of 1.51 (Large farmers=1.62 and small farmers=1.45) and hence, can be inferred as a profitable enterprise for improving the livelihood of rural community of Darchula district. Lack of timely availability of inputs and proper marketing chain were major constraints for the adoption of high density plantation. However, it can be a lucrative and sustainable commercial enterprise if proper spacing is maintained between the trees and optimum inputs are available in time.

Keywords: Apple, Economic, High density, Plantation

Need and Scope of Aquaculture apropos Economic and Nutritional Security: an Indian Perspective

Karunesh Verma^{*}, Rishabh Singh Gaur, Amrita Kumar Sarkar and S. P. Lal

PG Department of Extension Education, Dr. Rajendra Prasad Central Agricultural University Pusa, Samastipur, Bihar-848125, India

ABSTRACT

India is beatified with vast and diversified natural resources. It has 4% of global water resources. It consists of 195,210 km rivers & canals, 2.41 mha ponds & tanks, 0.812 mha flood plain lakes, 3.15 mha reservoirs, 3.9 mha estuarine along with 7516.6 km coastline, and so on. Being an aquatic resource-rich country, India ranks 3rd in fisheries production and 2nd in aquaculture, with 7.58% of share in the global production i.e. 13.75 MT (2018-19). Fisheries alone have employed 14.5 million people and contributed to 1.07% of the GDP and 5.23% of the total agricultural GDP. The marine products export stood at 13.93 lakh MT valued at ₹46,589 crores during 2018-19. The assessment and analysis are based on secondary data sources. Aquaculture production can be classified basically into fresh and brackish water aquaculture. About 65% of the aquatic production comes from inland freshwater aquaculture and rest from brackish aquaculture. In freshwater aquaculture 70-75% share comes only from 3 major carp viz. *Catla catla*, *Labeo rohita*, *Cirrhinus mrigala*. Under brackish water the major contribution is from crab, shrimp, viz. *Penaeus monodon*, *Penaeus vannamei* etc. India has much more potential than its present scenario of production if the available resources can be exploited wisely and

3rd International Conference on “Global Initiative in Agricultural, Forestry and Applied Sciences for Food Security, Environmental Safety and Sustainable Development (GIAFAS-2021)”

scientifically. Some developed countries have formulated and adopted few advanced techniques of aquaculture i.e. Bluefin tuna, salmon, sturgeon, mackerel, crocodile farming, etc. India's 14% population is undernourished, ranks 94th in Global Hunger Index 2020 with a score of 27.2. The aquatic foods are highly nutritious containing a wide range of essential nutrients viz. protein, minerals, fatty acids, omega-3 fatty acids, and carbohydrates. Fish accounts for about 17% of the animal protein need. Food security doesn't just concern food production rather defined as the physical and economic access to sufficient, safe, and nutritious food to meet dietary needs. At present 429 FFDA's, 39 BFDA's, AICRP and various research institutes are working tremendously for aquaculture development. So, it can be concluded that Indian aquaculture has a huge potential and is relevant in countering the economic, nutritional, as well as employment needs of the country.

Keywords: *Aquaculture, Fisheries, Freshwater & Marine sources and Water resources.*

Organic manure as an alternative to the conventional mineral fertilizers in cultivation of *Digitalis purpurea* L.

Yashwant Singh Tariyal*, Sadaf Ansari and Pratti Prasad

ABSTRACT

Digitalis purpurea L. commonly known as foxglove or *tilpuspi* is an important medicinal as well as ornamental plant due to the presence of cardiac glycosides in leaves of plant and purple and white coloured flowers which are used as vase plant or for decoration. Flowers and seeds are devoid of glycoside content, so they are safe to use for decoration. As far as cultivation of medicinal plant is concern it is important to follow the appropriate cultural practices to get higher yield and quality produce. Medicinal and aromatic plants are valuable natural resources having great potential for the improvement of the economy and health worldwide. Extensive exploitation of these plants from natural sources put great threat to their survivable. Cultivation of medicinal and aromatic plant is the best alternative for the conservation of these plants without affecting their supply for the health care system. From the long time use of chemical fertilizers has leads to the degradation of soil health. From earlier studies it was also reported that extensive use of mineral fertilizers has negative impact on the soil and plant health. The present experiment was conducted aiming to improve the yield and plant growth without leaving any adverse impact on soil and surrounding. For the current experiment different organic manures were used as individual and in combination with each other and performance were compared with the recommended dosage of mineral fertilizers and plant with no fertilizer. The different manure used were vermicompost, farmyard manure and litter compost along with the recommended dosage of NPK. The seedlings were prepared in nursery and transplanted in treated main field after about a month or they attain the height of 10-15cm. The experiment was layout in randomized block design with twelve treatments and three replications of each treatment. Organic manuring significantly affects the growth of the plant. Indicating that source of nutrient also plays an important role in the growth of plant. Vermicompost individually and in combination with mineral fertilizers and other manures shows significant effect on plant growth and yield. The increase in the growth and yield of the plant by applying vermicompost was found significantly higher than that of the plants grown under mineral fertilization. In experiment we observed that vermicompost significantly increases the number of leaves and leaf length during both seasons. It also increases the fresh and dry yield during second season of plant growth. Whereas in combination with litter compost it enhances the leaf fresh weight, leaf dry weight at both season and fresh and dry yield during first season of plant growth. Moreover, it was observed that vermicompost in combination with the farmyard manure increases the leaf area during both seasons. Leaf width was found enhanced by the application of farmyard manure. Replacing a portion of recommended dosage of mineral fertilizer with vermicompost shows increase in leaf with during the second season of plant growth. The results obtained shows that the organic manures can be successfully replace the mineral fertilizers without adversely affecting the growth and yield traits. It was also reported that with prolong use of mineral fertilizers there was change in the physical and chemical properties of soil which makes it adequate for the cultivation of plants. According to the GAPs for medicinal and aromatic plants the use of mineral fertilizers should be minimized, and the emphases should be on total organic cultivation. The use of organic manure had improved the growth and yield parameters in digitalis. From the findings of current investigation organic manure are suitable for the replacement of mineral fertilizers. They not only enhance the growth, yield and quality of plants but also show positive effect on soil health without any residual effect unlike mineral fertilizers. The effect of organic manure and mineral fertilizer on the active constituent should be studied for the optimization of nutritional requirement of plant for better quality and yield.

Keywords: *Organic farming, vermicompost, farmyard manure, compost, Digitalis purpurea*

Impact of Salicylic acid on Morphological traits of *Valeriana wallichii* DC under Drought stress

Sadaf Ansari, Yashwant Singh Tariyal and Babita Patni

ABSTRACT

Medicinal plants are most valuable treasure for the economy and the health sector of the country and *Valeriana wallichii* is one of them. Its multiple uses make it an imperative herb as it is used in pharmaceuticals, cosmetics as well as for perfumery. It was reported that only 20-30% of herbal raw drug is procured from cultivation and rest is still harvested from natural sources. Overexploitation and global climate change is a major constraint for the survivable of natural population. Adverse environmental conditions cause various abiotic stresses among which drought stress is the major stress that limits the growth and development of the plant. Phytohormone like salicylic acid induces stress tolerance to alleviate the effect of drought stress and increase plant productivity and economic yield. Therefore, present study was carried out with the aim to evaluate morphological alterations induced by salicylic acid in *V. wallichii* under drought stress conditions. In the experiment four concentration of salicylic acid (1mM, 0.75mM, 0.50mM and 0.25mM) at various levels of drought stress (100% FC, 75% FC, 50% FC and 25% FC) and their interactions along with their respective controls were evaluated. Increasing drought stress caused significant reduction in plant height, leaf numbers, leaf length, leaf width, leaf area, plant spread, rhizome thickness, shoot, root and rhizome length, fresh and dry shoot weight and fresh and dry root weight except leaf thickness at both vegetative and flowering stage in leaves as well as in roots. Foliar application of salicylic acid improves morphological and yield attributing traits under water deficit condition. It was noted that at 100% FC, 0.25mM SA concentration found effective during vegetative and flowering stage in leaves as well as in roots. At 75% FC, 0.25mM SA concentration was found effective during flowering stage in leaves as well as in roots while 1mM is useful only during vegetative stage in leaves. At 50% FC, different concentration of SA positively effect in leaves during vegetative stage (*i.e.*, 0.25mM SA concentration), flowering stage (*i.e.*, 0.50mM SA concentration) and in roots (*i.e.*, 1mM SA concentration) found effective. And similarly, at 25% FC, 1mM concentration of SA was found best among all the concentrations during both the stages of leaves *i.e.*, vegetative and flowering stages as well as in roots in comparison to respective control values. From the experiment, it can be concluded that the deleterious effect of increasing drought stress can be reduced by higher concentration of SA (*i.e.*, 1mM SA) whereas from moderate to well-watered condition lower concentration of SA were found at par with higher concentration of SA. Hence, it is evident that foliar spray of SA improves all the morphological traits in plants directly or indirectly so that it can be helpful to overcome the hazardous effect of drought stress and improve qualitative and quantitative yield of such a valuable medicinal plant.

Keywords: *Salicylic Acid (SA), Tagar, Valeriana wallichii, Drought Stress.*

Study on Knowledge and adaption of soil testing regarding utility of soil health card in Maharajganj district of Uttar Pradesh

¹Girijesh Kannaujiya, ¹R.K. Doharey, ¹Abhinav Singh, ²Niyaj Ahamad

¹*Dept. of Extension Education*

²*Dept. of Plant Molecular Biology & Genetic Engineering, A.N.D. University, Kumarganj, Ayodhya*

ABSTRACT

Present study in titled “study on knowledge and adoption of soil testing regarding utility of soil health card in Maharajganj district of Uttar Pradesh” conducted in Maharajganj District of U.P., District Maharajganj and two blocks namely Nichlaul and Mithaura block were selected purposively for present study, village and respondents were selected randomly. Five villages were selected randomly from each block and 15 farmers from each village. Therefore, a total of 150 farmers selected for present study in which larger number of farmers have been getting benefits of soil health card regarding soil testing. Result revealed that Majority of the respondent were found in middle age category (35-61 years) *i.e.* 36.66 percent, majority of the respondents were found in literate category, maximum number of respondents were found married, most of the respondents were belonged to Hindu religion, rate of OBC caste is higher in the study area, most of the respondents were belonged to nuclear family, most of the respondents were belonged to small sized family, most of the respondents were marginal farmers maximum numbers of respondents were engaged in farming with animal husbandry, most of the respondents had mixed housing pattern, majority of respondents were not participated in any organization, most of the respondents had income between 1, 00,000 Rs to 2, 00,000 Rs. In extension contact, most of the respondents were given preference to Gram Pradhan, family, and TV in aspect of formal sources, informal sources, and mass media exposure respectively, in Material possession, Respondents have good

3rd International Conference on “Global Initiative in Agricultural, Forestry and Applied Sciences for Food Security, Environmental Safety and Sustainable Development (GIAFAS-2021)”

number of pumping set/diesel engine for farm power, sickle and khurpi were major implements for agricultural work, maximum respondents had bicycle for transportation, chair cots and wall watch were major household materials, mobile is major component for communication media possessions. Most of the respondents having medium economic motivation, medium level of scientific orientation, and medium level of risk orientation and majority of respondents had medium level of awareness. In which material possession were found significant and Majority of the farmers had medium level of utilization pattern in which age and extension contact were found significant.

Keywords: *Soil health card, Soil testing, Adaption.*

Genetic variability and association studies of marketable traits in gladiolus (*Gladiolus hybridus* Hort.) in Bundelkhand Conditions

Rakesh Kumar^{1*}, Ajay Kumar Singh², Krishna Singh Tomar³ and Amit Kanawjia⁴

Department of Floriculture and Landscape Architecture, Banda University of Agriculture and Technology, Banda 210001, India

ABSTRACT

An experiment was carried out with fourteen varieties of gladiolus planted in RBD with three replications at Experimental Farm, College of Horticulture, Banda University of Agriculture and Technology, Banda during 2017-18 and 2018-19. The experiment was undertaken to study genetic variability, trait association through correlation and path analysis in Bundelkhand conditions of Uttar Pradesh. ANOVA revealed significant differences for all morphological characters, indicating considerable amount of variability among the genotypes. Spike length ranged from 65.07 cm to 110.65 cm and floret size ranged from 8.27cm to 9.66 cm. Mean value for days taken to flowering, floret size and vase life is 109.38 days, 8.95 cm and 8.95 days, respectively. Moderate values for PCV and GCV were exhibited by rachis length (19.97 and 15.90), spike length (18.49 and 14.40) and number of florets per spike (14.88 and 12.05). Heritability value was found maximum in days taken to flowering (68.22) and minimum in size of floret (35.63). Plant height, spike length, rachis length, duration of flowering and number of florets per spike were positively and significantly correlated with days taken to flower initiation and days taken to flowering. Path coefficient analysis revealed that spike length (1.162) exerted maximum positive direct effect on plant height followed by days taken to spike initiation (0.881) and duration of flowering (0.392).

Keywords: *Gladiolus, Variability, Correlation, Spike, Rachis, Corm.*

Influence Of Potting Media Composition On Quality Flower Production Of Petunia (*Petunia Hybrida*)

Ajay Kumar Singh, Rakish Kumar, K.S.Tomar, Arvind Gupta, Hitesh Kumar and Rahul Patel

Banda University of Agriculture & Technology, Banda, 210001, Uttar Pradesh

ABSTRACT

An experiment was conducted at Banda University of Agriculture & Technology, Banda to evaluate the effect of different growing media compositions containing cocopeat, Vermicompost, FYM, Leaf Mould, Perlite and vermiculite in different ratios on vegetative growth and flowering of Petunia plant. The results revealed that, the maximum root length and root spread were observed in media composition T5 [Cocopeat + Vermicompost + Vermiculite (2:1:1)] whereas, vegetative growth with no of leaves per plants, no of branches per plant and plant spread in T4 [Cocopeat + Perlite + Vermicompost (2:1:1)]. The better flower quality parameters like flower diameter, flower bud diameter, stalk length of flower were observed in T5 media containing Cocopeat + Vermicompost + Vermiculite (2:1:1) while minimum days taken to bud initiation (60.75) and first flower opening (66.66) in T2 [Soil + Sand + Vermicompost (2:1:1)]. However, plants showed the significant root growth, vegetative growth with better flowering time and quality was highest in media containing Cocopeat + Vermicompost + Vermiculite (2:1:1). Therefore, the findings suggest that for quality flower production of potted Petunia growing media composition of T5 [Cocopeat + Vermicompost + Vermiculite (2:1:1)] was ideal with better plant morphological development and sustained flowering for display.

Agricultural Crop Residue Utilization for Sustainable Bioenergy Production: an Asian Perspective

Jayashree Dey Sarkar¹, Amrita Kumar Sarkar², Prithusayak Mondal³, Prasanta Kumar Bandyopadhyay¹, and S. P. Lal²

¹Department of Agricultural Chemistry and Soil Science, Bidhan Chandra Krishi Viswavidyalaya, Mohanpur, Nadia, West Bengal-741252, India

²Department of Extension Education, Dr. Rajendra Prasad Central Agricultural University, Pusa, Samastipur, Bihar-848125, India

³Regional Research Station (Terai Zone), Uttar Banga Krishi Viswavidyalaya, Coochbehar, West Bengal-736165, India

ABSTRACT

Asia is the largest continent on earth, comprising about 16% of its land area and the world's most populous continent with a population density of an average of 1.87 persons per hectare. To meet up the food demand of this burgeoning population the green revolution had been introduced with varieties of crops and fertilizers. With the increase in food grain production, the production of crop residues also increases day by day, however, only a tiny proportion of this vast amount of crop residues are being used by Asian farmers as feed for livestock, bedding material, mulching, and fuel purpose. The rest these residues are dumped for decomposition or burn in situ. As a result, a significant amount of greenhouse gases are produced from these leftovers. Among the top ten emitter countries of methane (CH₄) in the world from agricultural crop residues, five are from Asia in which China is the number one emitter (179.13 kilo tonnes), followed by India, Russia, Indonesia, and Thailand, respectively as per last 10 years average. Hence, in the present farming situation in Asian countries, agricultural residues are becoming increasingly problematic and causing a severe threat to the environment. But these lignocellulose-rich agricultural crop wastes have high calorific value with the huge potentiality to produce biofuel for bioenergy, one of the most important renewable energy sources. So, agricultural leftovers are converted into various bioenergy forms through biochemical or thermochemical conversion processes. Bioenergy can promote the shifting from the petroleum-based economy to the bioeconomy for long-term development. Hence, utilizing residues to mitigate environmental hazards and provide energy security for future generations, agricultural crop residue-based bioenergy production may open a new aspect in sustainable energy production. It can act as an alternative to fossil fuels. Its production cost is comparatively lower and is profusely available at a lower price. Thus, in Asian countries, crop residue-based bioenergy production can contribute to attaining the 7th goal of sustainable development goals (SDGs) which is to secure access to affordable, reliable, modern as well as sustainable energy for all.

Keywords: Agricultural residues, Bioenergy, Energy security, Environmental hazards, Renewable energy, Sustainable Development

Drought stress related grain quality traits of wheat (*Triticum aestivum* L.) varieties

Dommalapati Sudhakara Rao^{1*}, Midathala Raghavendra¹, Parveen Gill², Shashi Madan¹ and Renu Munjal³

¹ Department of Chemistry and Biochemistry, ²Department of Zoology, ³Department of Genetics and Plant Breeding, Chaudhary Charan Singh Haryana Agricultural University, Hisar-125 004, Haryana

ABSTRACT

Climate change imposes many environmental stresses out of which drought stress is a major concern that significantly restricts crop production in arid and semi-arid regions. The negative impact on grain quality caused by drought stress is responsible for reduced grain yield and quality. In the present investigation some wheat grain quality traits were evaluated to know how the drought stress affected nutritional quality. Sedimentation value, β carotene, crude fibre, total sugars and starch were evaluated in drought stressed grains. Sedimentation values (ml) were increased more in WH 1025 (6.9 per cent) than WH 1105 (3.8 per cent). β -carotene content ($\mu\text{g g}^{-1}$ DW) of wheat varieties under irrigated and drought stress conditions was measured and found that the β -carotene content followed consistent pattern under drought stress condition. In WH 1105 the value noted was 3.9 and 3.7 $\mu\text{g g}^{-1}$ DW while in WH 1025 the value was 4.1 and 3.9 $\mu\text{g g}^{-1}$ DW under irrigated and drought stress conditions respectively. The crude fibre content was 1.65 and 1.55 per cent under irrigated and drought stress conditions respectively while in WH 1025 crude fibre content was 1.73 and 1.63 per cent under irrigated and drought stress conditions respectively. Decreasing pattern was observed for total sugar content in both wheat varieties under drought stress condition over irrigated condition. Starch content decreased under stress.

3rd International Conference on “Global Initiative in Agricultural, Forestry and Applied Sciences for Food Security, Environmental Safety and Sustainable Development (GIAFAS-2021)”

Reduction in starch content in WH 1105 was 5.76 per cent, while in WH 1025, it was 4.25 per cent. From data it is evident that drought stress affected grain quality traits studied.

Keywords: *Wheat (Triticum aestivum L.), drought stress, grain quality traits, sedimentation value, β carotene, crude fibre, total sugars and starch.*

Impact of Trichoderma linked IDM trainings on management of Major Diseases of Horticulture Crops in Kalaburgi District of Karnataka

Zaheer Ahamed, B , Vasudev Naik, Raju Tegelli G, Yusuf Ali N and Shreenivasa B V

ICAR-Krishi Vigyan Kendra, Kalaburagi, University of Agricultural Sciences, Raichur – 584104, Karnataka

ABSTRACT

A study was undertaken in 30 FLD villages from the period of 2016 to 2019 covering 160 farmers in 32 trainings with area coverage of 2500 ha helped the farmers to come out of major soil borne diseases. These diseases causes huge crop loss in medium black soil of Kalburgi district. Watermelon wilt, pomegranate dieback, Guava seedling stage root rot, Papaya collar rot, Chilli damping off is the major problems effectively handled by the KVK trained farmers under field condition. Few of the trained farmers preparing nursery after KVK and UASR bio control unit short term trainings. The planters now knows that fungicide in long run not works to combat the disease in horticulture crops, hence ecofriendly management of disease through biocontrol agent produced by UAS Raichur taking upper hand now a days and farmers adopting this through foliar sprays, enriching with FYM and Neemcake, portray application and spot applications to soil. Continuous use of fungicides results in detrimental effect on environment and development of resistant strains of the pathogen, health hazards to an applicator as well as to a consumer of the treated material. The biological control agent method of usage, its role awareness, time of application, compatibility with other chemicals made the district farmers to adopt the fruitful technology of plant protection.

Strengthening Marketing Through E-Commerce

Parveen Kumar* and Vijay Kumar**

** KVK-Leh, SKUAST-K*

***Agriculture Extension, DoA, J&K*

ABSTRACT

Agriculture in India has been plagued by the absence of a robust marketing structure. This has led to the lack of farming community at the hands of middlemen and commission agents. This is also a reason why the agriculture sector is being perceived as a non remunerative sector. The farming community works day and night in the fields but unfortunately does not get the intended monetary benefits. A large chunk of his hard earned money goes to persons' who does not have even seen their fields. Now, with the advent of new technologies lie the e-marketing portals, adequate marketing support is being provided to the farming communities. Such technologies have also helped in reducing post harvest wastage by improving market efficiency. Through such technologies, the reach of agricultural products can be extended beyond boundaries. A promising intervention in this regard is the e-commerce. E-Commerce refers to the buying and selling of agriculture produce as well as services between parties involved. It also involves payment accomplishment of the goods and services via an online platform (electronic means). People also call it internet retailing. Electronic National Agriculture Market (e-NAM) constitutes a perfect example of e-commerce in the realm of agricultural marketing in India. It can be differentiated with popular e-commerce as it only involves B2B trade where general e-commerce involves mainly B2C trade. E-commerce in this sector presents a wide range of economic benefits to farmers, communities, consumers and to the wider society as a whole, in the form of improved income and livelihood. By improving market efficacy, agri e-commerce services ensure that the post harvest losses are minimized. The transparency and efficiency followed by e-commerce companies helps to avoid this post harvest loss and eliminate the role of unnecessary middlemen resulting in inventory reduction which makes it easier for farmers to sell their produce to consumers at competitive rates. For instance, farmers selling fruit and vegetables through Frubana in Colombia record post-harvest losses of 3%, compared with the average of 58% for farmers that sell through traditional channels. E-

commerce offers a considerable scope in India too because of the increased penetration of mobile users in the rural areas.

Socio-economic and communication characteristics of farm women using ICT tools
Shivani Jha^{1*}, S. K. Kashyap², M. A. Ansari³, Deepshikha Gariya⁴, Smriti Singh⁵

¹ Punjab Agricultural University, Ludhiana, Punjab, India

^{2,3,4,5} Department of agricultural communication and extension, GBPUAT, Pantnagar, Uttarakhand, India

ABSTRACT

Agriculture is the base of the Indian economy. About 70 percent population lives in villages out of which primarily 47 percent workforce is in agriculture (FAO 2010). Thus, we can say that the Indian economy is primarily agrarian. The introduction of new farming technologies like high-yielding variety seeds, new implements, etc. along with efforts of extension system to disseminate such technologies to farmers ushered in the green revolution in the country. Farm women play an important and crucial role in agricultural development. The agriculture sector employs 80 percent of all economically active women out of which 33 percent constitute the agriculture labor force and 48 percent are self-employed (OXFAM, 2018). Around 70 percent of all women engaged in cultivation are from households witnessing migration (NSSO, 2013). ICT tools aim to improve the lives of farm households, especially in rural areas by providing them the appropriate and relevant information. Traditionally the extension services have focused on male farmers. In the last few decades, the concern regarding farm women has been raised globally. Farm women perform several activities like producing crops, tending animals, cooking food, working for wages in agricultural or different rural enterprises, collecting fuel and water, selling agricultural produce and caring for members of the family, and maintaining their homes.

Keywords: Agriculture, Farm women, ICT tools, extension, migration.

Antibacterial potential of methanol extract of invasive plant *Sonchus wightianus* DC. leaf from Kumaun Himalaya

Amrendra Nath Tripathi and Suresh Chandra Sati

Department of Botany, D.S.B. Campus, Kumaun University, Nainital-263001, Uttarakhand, India

ABSTRACT

The uses of plants in the traditional system in developing countries are numerous and diverse. Drugs developed from plants play an important role to treat several infectious diseases of human beings. It might be due to the low accessibility and having no side effects of western health care system in developing countries. Some plants have been scientifically proved by researchers for their therapeutic potential till now, but the remedial ability of number of plants are still unknown. *Sonchus wightianus* DC. (Asteraceae) commonly known as “White sow thistle” used traditionally for curing cough and bronchitis. To know the susceptibility of plant / parts against disease causing microorganisms, the sensitivity of four pathogenic bacteria (*Bacillus cereus*, *Bacillus megaterium*, *Agrobacterium tumefaciens* and *Xanthomonas campestris*) were tested against the crude methanol extract of leaf part of *S. wightianus* of Kumaun Himalaya, employing disc diffusion method. The methanol extract exhibited highest zone of inhibition (19 mm) against *A. tumefaciens* whereas lowest ZOI (16 mm) were shown against *B. megaterium* and *X. campestris*. The standard antibiotics Gentamycin (50 mcg) was used as positive control in this experiment. This study indicates that the methanol extract of leaf part of *S. wightianus* is quite effective to combat bacterial diseases of plants as well as human beings.

Keywords: Antibacterial activity, Crude extract, Gentamycin, Kumaun Himalaya

Lemon grass-a new paradigm for farmers, eco-systems and sustainable development of livelihood under Bundelkhand Agro-climatic zone

B.S. Kirar, R.K. Prajapati and Jaipal Chhigarh

Jawaharlal Nehru Krishi Vishwa Vidyalaya, Krishi Vigyan Kendra, Tikamgarh (M.P.) 472001

ABSTRACT

3rd International Conference on “Global Initiative in Agricultural, Forestry and Applied Sciences for Food Security, Environmental Safety and Sustainable Development (GIAFAS-2021)”

The impact of climate change is evidently visible in Bundelkhand region of Madhya Pradesh. Climate change has hit the agriculture based livelihoods and food grain production in the Bundelkhand districts has decreased by 58%. Bundelkhand is a problem region due to extremely rainfall events, prolonged dry spells, early with drawl monsoon or late commencement of monsoon, uneven rain fall distribution and at different crop growth stages. Drought condition, low rainfall, hot climate, arid and ravine lands, low quality in irrigation in term of sustainability and the availability of water resources. Defunded old water storage bodies resulted to reduction of ground water level and nondiscretionary use of water really lead to low agriculture crop productivity. All these realities were evidently showing that Bundelkhand is still facing the grave tragedy of drought. The major Kharif crops-soybean, black gram and sesame cropped area come under rainfed cultivation which was observed the failure of crops due to uncertain rainfall. While the Rabi crops like wheat, mustard and chickpea were depending up on the rain amount of Kharif due to ensure the availability of irrigation water. The soil like light, medium is the sharing 75% part which are not suitable for high value cropping as well as farming system due to low water and nutrients holding habits. The 75% farmers were under marginal, small which were not having agriculture implements and did traditional cultivation. National Innovations on Climate Resilient Agriculture (NICRA) was a network project. The project aims to enhance resilience of Indian agriculture to climate change and climate vulnerability through strategic research and technology demonstration. The KVK (Krishi Vigyan Kendra) Tikamgarh (M.P.) was implemented the NICRA project through adaptive village -Kanti of district- Tikamgarh which situated under Bundelkhand Agro-climatic zone of Madhya Pradesh. The farmers were grown major crops failed or damaged 90-100% due to climatic hazards. There was a need for resilient practice *i.e.* short duration, drought resistant crops varieties, low water requirement crops, low cost cultivation and high value crop. The project of DBT was launched with convergence of IIIM, Jammu. Under the project, the lemongrass (*Cymbopogon pndulus*) variety CPK-25 and rosagrass (*Cymbopogon khasianus*) variety CK-10 cultivation were promoted in light to medium soil of 25-farmer field as demonstrations. Two oil extortion plants were also established for oil extraction, each demonstration was conducted in one-acre area with 3-4 slips planted at one spot at a spacing of 40X 40 cm in Oct-Nov., 2020, The basal dose of 40 kg/ha phosphorus and 40 kg/ha potash were applied before the planation. Nitrogen at the rate of 80 kg/ha were given in the split dose at sufficient moisture stage of the crop. First harvesting was taken after 145-180 days of planting *i.e.* June 2021. The crop yield 17-18 tone/ha herbage, 75-90 kg/ of oil with net profit from Rs. 75000 to 90,000/ha in lemon grass was obtained while in rosa grass the crop yield was 50-55 tone/ha of fresh herbage with 130-180 kg/ha oil. The net profit was obtained 130,000 to 180000/ha. The less rainfall and very late monsoon in 2021 were impact the failed of major other crops cultivation in district but the farmers could have got net profit from these drought resistant grass even in extremely adverse climate. The impact on major crops and the cultivation of these grass was found suitable for Bundelkhand climatic situation. The cultivation technology now is being popularized and horizontally spreading in the district from 25 acres to 100 acres.

Keywords: Lemongrass, Rosagrass, Climate change, Drought

Lemongrass comes as boon for drought-hit Bundelkhand Agro-climatic zone farmers

T. R. Sharma, R.K. Prajapati and P.K. Gupta

Jawaharlal Nehru Krishi Vishwa Vidyalaya

ABSTRACT

The cultivation of medicinal and aromatic crops provides sustainable means of natural source of high value industrial raw material for pharmaceutical, agro-chemical, food and cosmetic industries and opens up new possibilities for higher level of gains for farmer with a significant scope for progress in rural economy. The global demand for lemongrass oil is increasing tremendously due to high citral content. Once faced with threats of dwindling income due to climate change in tough and barren terrain such as Bundelkhand Agro-climatic zone of Madhya Pradesh farmers are now hoping to cash in on high variety aromatic crop- lemongrass (*Cymbopogon pndulus*) they have started growing varieties are being grown and farmers are ensured of income even under extreme weather conditions under a scheme launched by the IIIM, Jammu (CSIR) in convergence with KVK, Tikamgarh (M.P.). The impact of climate change is evidently visible in Bundelkhand region of Madhya Pradesh. Climate change has hit the agriculture based livelihoods and food grain production in the Bundelkhand districts has decreased by 58%. Bundelkhand is a problem region due to extremely rainfall events, prolonged dry spells, early with drawl monsoon or late commencement of monsoon, uneven rain fall distribution and at different crop growth stages. Drought condition, low rainfall, hot climate, arid and ravine lands, low quality in irrigation in term of sustainability and the availability of water resources. Defunded old water storage bodies resulted to reduction of ground water level and nondiscretionary use of water really lead to low agriculture crop productivity. All these realities were evidently showing that Bundelkhand is still facing the grave tragedy of drought. The major Kharif crops-soybean, black gram and sesame cropped area come under rainfed cultivation which was observed the failure of crops due to uncertain rainfall. While the Rabi crops like wheat, mustard and chickpea were

depending up on the rain amount of Kharif due to ensure the availability of irrigation water. The soil like light, medium is the sharing 75% part which are not suitable for high value cropping as well as farming system due to low water and nutrients holding habits. The 75% farmers were under marginal, small which were not having agriculture implements and did traditional cultivation. The farmers were grown major crops failed or damaged 90-100% due to climatic hazards. There was a need for resilient practice *i.e.* short duration, drought resistant crops varieties, low water requirement crops, low cost cultivation and high value crop. Under the project, the lemongrass (*Cymbopogon pendulus*) variety CPK-25 (hybrid) and rosagrass (*Cymbopogon khasianus*) variety CK-10 cultivation were promoted in light to medium soil of 25-farmer field as demonstrations of Kanti- village of Tikamgarh district. Two oil extortion plants were also established for oil extraction, each demonstration was conducted in one-acre area with 3-4 slips planted at one spot at a spacing of 40X40 cm in Oct-Nov., 2020, The basal dose of 40 kg/ha phosphorus and 40 kg/ha potash were applied before the planation. Nitrogen at the rate of 80 kg/ha were given in the split dose at sufficient moisture stage of the crop. First harvesting was taken after 145-180 days of planting *i.e.* June 2021. The crop yield 17-18 tone/ha herbage, 75-90 kg/ of oil with net profit from Rs. 75000 to 90,000/ha in lemon grass was obtained while in rosa grass the crop yield was 50-55 tone/ha of fresh herbage with 130-180 kg/ha oil. The net profit was obtained 130,000 to 180000/ha. The less rainfall and very late monsoon in 2021 were impact the failed of major other crops cultivation in district but the farmers could have got net profit from these drought resistant grass even in extremely adverse climate. The impact on major crops and the cultivation of these grass was found suitable for Bundelkhand climatic situation. The cultivation technology now is being popularized and horizontally spreading in the district from 25 acres to 100 acres. The idea is to ensure value addition of lemongrass crop in the form of high-end aroma chemicals and products as well as encourage skill development activities which will check migration too. The lemongrass cultivation, apart from promoting selected crops for the production of essential oils, will also promote, among the farmers and entrepreneurs, value addition of these oils by isolating the desired chemicals, modifying these for higher values, and using these for the products which can be manufactured at a smaller scale with low investments. This will help the unemployed youth turn into an entrepreneur and will also generate employment opportunities especially to women. Lemongrass mission have been encouraging, promising to change the lives of Bundelkhand farmers

Keywords: Lemongrass, Rosagrass, Climate change, Drought

Molecular characterization of monopartite *Bhendi yellow vein mosaic virus* infecting wild okra (*Abelmoschus moschatus* ssp. *moschatus*) in India

Pooja Kumari^{1*}, SP Singh⁵, KK Gangopadhyay², VC Chalam¹, Basavaraj Y. B³, V. Venkataravanappa⁴, Ashwini Kumar³ and Satish Kumar Yadav⁶

¹Division of Plant Quarantine, ICAR-National Bureau of Plant Genetic Resources, New Delhi 110012, India

²Division of Germplasm Evaluation, ICAR- National Bureau of Plant Genetic Resources, New Delhi 110012, India

³Division of Plant Pathology, ICAR-Indian Agricultural Research Institute, New Delhi 110012, India

⁴CHES, ICAR-Indian Institute of Horticultural Research, Chettalli, Madikeri District, Bangalore, Karnataka 571248, India

⁵National Research Centre for Integrated Pest Management, New Delhi 110012, India

⁶Division of Germplasm Exchange & Policy Unit, ICAR-NBPGR, New Delhi 110012, India

ABSTRACT

Bhendi yellow vein mosaic disease (BYVMD) is most devastating viral diseases of okra which affects yield and quality of the produce in India. The causative agent of BYVMD is begomovirus *viz.*, *Bhendi yellow vein mosaic virus* having DNA-A molecule along with betasatellite. In this study, we have made an attempt to find out the diversity of begomovirus and its satellite nucleotide sequences derived from wild okra (*Abelmoschus moschatus* ssp. *moschatus*) infected samples exhibiting conspicuous symptom of BYVMD using PCR based detection technique on two wild okra symptomatic samples *viz.*, EC361170 and EC361148 collected from experimental farm of ICAR-National Bureau of Plant Genetic Resources, New Delhi, India. Full length amplification of BYVMV satellite molecule and partial amplification of DNA-A was carried out using PCR and cloning to both randomly selected samples which showed the presence of monopartite BYVMV. In both samples, presence of DNA-A molecule, betasatellite and alphasatellite were noticed. This is the first study which showed the presence of alphasatellite molecule of BYVMV from New Delhi region in wild okra (*A. moschatus* ssp. *moschatus*).

Keywords: Begomovirus, Wild okra, Alphasatellite, Betasatellite, Bhendi yellow vein mosaic disease

Evaluation of Modified Onion Storage Structure under Northern dry zone of Karnataka

P. V. Naik, ZaheerAhamed, MahanteshJogi, RajuTeggeli, Yusufali and Shreenivas B.V.

ICAR KVK, Kalaburagi, UAS Raichur

ABSTRACT

The rate of deterioration of onion in the arid dry zone environment due to inadequate storage structure cannot be overemphasized. The storage life of onion is dependent mainly on temperature and humidity. Onion is grown in the north east dry zone mostly by small and marginal farmers and transportation is the major problem to the various regions in the country. To ensure supply of the commodity all year round, adequate storage facilities must be put in place. The objective of this study is to evaluate a modified onion storage structure in terms of its potentials to reduce sprouting of bulbs, post harvest loss by modifying the temperature and relative humidity and increases the air circulation in storage structure which would help extend the shelf life of onion and reducing post-harvest losses. A storage structure capable of storing onions in a north dry zone-I and II. The environment was redesigned and constructed using locally available materials and tested for 12-weeks. The structure was constructed with 0.8 m height of base \times 4.50 m width and 4 m height \times 30 mm GI soft without exhaust fan, naturally ventilated and was covered with asbestos roofing sheets and chicken mesh. The storage structure is 10 m \times 4 m \times 5 m for length, breadth and height respectively with exhaust fan 1400 RPM with perforated 12mm PUC pipes and is divided into three compartments (Based on size of bulb divided in to A, B and C). and another heap method with exhaust fan 1400 rpm. The parameters measured included temperature, relative humidity and weight of the onions and the results were subjected to appropriate statistical analysis. Temperatures within and outside the structure ranged from 24.5°C to 33.5°C in the morning period, 32.0°C to 43.2°C in the afternoon period and 30.0°C to 34.6°C in the evening period. Physical examination performed on the stored onions bulbs after twelve weeks revealed minimum deterioration, with onions stored at compartment A recording the lowest percentage of weight loss of 7.2% while compartment B had a 12.11% weight loss and compartment A recorded a 18.9% weight loss. Relative humidity within and outside the structure ranged from 54% to 66% in the morning, 51% to 75% in the afternoon and 66% to 82% in the evening. The highest relative humidity value (82%) was recorded in the morning period and the lowest (51%) was recorded in the afternoon. The test of correlation analysis performed on the results indicated large significant difference between the internal and external temperature and relative humidity readings. It is concluded that the structure has performed well by reducing ambient temperature and relative humidity thereby prolonging the shelf life and reduced the postharvest loss of the product.

X-Ray Induced Mutagenesis For Improved Grain Yield And Nutritional Value Of Maize (*Zea Mays L.*)

Oke, EJ^{1*}, Yilwa, VM¹; Appah, J¹, Mbah, EU², Kwon-Ndung, EH³

¹ *Department of Biological Sciences, Faculty of Science, Nigerian Defence Academy, Kaduna*

² *Department of Agronomy, College of Crop and Soil Sciences, Michael Okpara University of Agriculture, Abia State*

³ *Department of Botany, Federal University, Lafia, Nasarawa State*

ABSTRACT

The seeds of certified hybrid maize (Oba super 2), were exposed to three different doses of X-ray radiation: 3 MGy, 6 MGy, 9 MGy and the control (0 MGy). The experiment was laid down in a randomized complete block design (RCBD) during the 2016 cropping season at Michael Okpara University of Agriculture, Umudike (latitude 05° 29' N; longitude 07° 33' E; altitude 122 m above sea level) Abia State in the humid tropics of southeast Nigeria. Results showed that exposing maize seeds to X-ray irradiation prior to planting significantly influenced the growth and some growth indices (crop growth rate, relative growth rate, absolute growth rate, and leaf area ratio) as well as yield, yield components and nutritional status of maize seeds. The application of 6 MGy of X-ray dose significantly gave the longest cob length, widest cob diameter, highest 100-seed weight and grain yield (4,973.00 kg/ha) relative to the other treatments. However, zero X-ray level of bombardment (control) gave significantly the highest β -carotene content, vitamin C, Fe, K, and P compared to the other treatments. The findings indicated that maize seeds induced with 6 MGy X-ray irradiation improved growth, grain yield and nutritional value of the crop, suggesting a possible genetic synergy from the dosage level. The implications of these results in line with the problems associated with maize breeding, can lead to further improvement of new maize grain varieties in Nigeria.

Keywords: *Maize, induced mutagenesis, X-ray, growth, nutritional value, grain yield.*

Loss of Food Grains Due to Insect pests in Storage

Shashi Bala

Dept. Of Zoology R.G. Girls PG College, Meerut – 250001

ABSTRACT

Storage of food grain is very serious problem. A large amount of food grain loosed by pest –infestation because of Insect pest detritus caused the food grain unfit for human being consumption in the form quality and quantity. It is reported that 20,000 field species and insect pests loosed one third food production, 43% loosed the food grains in developing world. In India 250 million tonns food grain loosed in which 20-25% due to insect pest in festation, during storage due to improper stratiges applied by rural farmers. Many of chemical pesticide are also available. But the chemical pesticide having negative Impact on Enviournment as well as human being, expensive undesirable. So we should promote at National International level have been made to reduce the use of chemical pesticide and Promotes the develops Ecofriendly approaches because of easily available, cheaper, pollution free targeting and safe for human health. It can be increase the income of rural farmers. In recent years reported plant origin pesticides use as grain protectants with good degree of success against Insect pest infestation and maintain quality of food grain in storage.

Keywords : *Post harvest, Insect pest, Food grains Eco friendly.*

Multi-facet Approach to recycle household waste into wealth: a Case Study of a Lady having Zero waste Lifestyle

Nisha Arya^{1*} and Sudhanand Prasad Lal²

¹ *Department of Family and Community Resource Management, Faculty of Family and Community Science, The Maharaja Sayajirao University of Baroda, Vadodara 390002 Gujarat, India*

² *PG Department of Extension Education, Dr Rajendra Prasad Central Agricultural University Pusa, Samastipur-848125, Bihar, India*

ABSTRACT

To create a healthy environment, it is critical to achieve effective solid waste management that involves not only formal/government agencies but also individual actions. The present study was undertaken to scrutinize the household waste management and zero waste lifestyle at an individual level. This study presents the findings of a case study of a woman who religiously follows ‘zero waste lifestyle’. Dr. (Mrs) Kiran Sinha, a conscientious lady of 53 years old, a well-educated woman, MD (Homeopathy in Paediatrics), who lives at the residential area of RPCAU Pusa, has always attempted to minimize the most of the waste generated in her home and convert it into a functional product. It was found that her house produced only 130-165 grams of waste per day because it was painful for her to simply throw food out as waste. She treasured to grow vegetables, flowers, sometimes cereals and foliage plants in sluggish things like polypropylene sack, e-shopping and other packaging bags, tin container, plastic bags etc. Dr. Kiran uses the dish water, impure water comes with the filtration of water and leftover water from washing vegetables, fruits etc. to irrigate her lovely kitchen garden. She was particularly fond of organic farming, thus she was against using chemical fertilizers like urea to help plants grow and make her own compost to nourish plants. This is how Dr. Sinha practices a "Zero Waste Lifestyle" and uses her countless hours to recycle waste and makes everything in her house multi-functional. The purpose of mentioning Dr. Kiran Sinha in this study is to highlight her accomplishments and to applaud her tremendous efforts to manage waste on her own level. It is expected that findings of this research focused on the best practices of woman towards zero waste lifestyle and to waste free and environment friendly practices at individual level. The current study is required to continue exploring best practices of households in the relevant fields and to promote their success stories around the world in various manners.

Keywords: *Case study, Environment, Household waste management, Recycle, Woman, Zero-waste*

EFFECT OF IRRIGATION SALINITY ON MORPHOLOGICAL CHARACTERISTICS OF RICE GENOTYPE

Megha Budakoti

Department of Plant Physiology, College of Basic Sciences & Humanities, G. B. Pant University of Agriculture & Technology, Pantnagar, Uttarakhand, India

ABSTRACT

The effect of salinity on morphological characters of salt sensitive Pant Basmati1, Pant Dhan24 and salt tolerant CSR30 genotypes were analysed in two factors Completely Randomized Design with three replications. Three genotypes under control and 100mM NaCl condition randomly assigned in a plastic pot. The different morphological characters such as plant height, total number of tillers, leaf number and Total Dry Matter (TDM) content were analysed under control and 100mM NaCl condition. Results showed that plant height, total tillers, root, shoot and total dry matter were significantly decreased by the application of 100mM NaCl. Highest reduction in all the parameters (Plant height, tiller number, leaf number and total dry matter) was found in Pant Basmati1 followed by Pant Dhan 24 at 100mM NaCl. Whereas, reduction rate was slower in CSR23 as compare to other genotypes.

Key words: Salinity, growth, yield, cultivars, rice.

Investigation of the allelopathic potential of *Parthenium hysterophorus* L. and *Pinus roxburghii* Sarg. on Tulsi (*Ocimum tenuiflorum*)

Monali Chauhan*, Sonam rawat, Pallavi Sati, M.C. Nautiyal

High altitude Plant Physiology research centre (HAPPRC), H.N.B. Garhwal University, Post Box: 14, Srinagar Garhwal, 246174, Uttarakhand, India

ABSTRACT

Allelopathic potential of an exotic herb *Parthenium hysterophorus* L. and an indigenous tree *Pinus roxburghii* was critically evaluated by physiological and biochemical attributes. All the disciplines were critically explored by using a number of reliable indices which can justify the allelopathic property of the two experimental species. The allelopathic potential of aqueous extract of different parts viz, leaf, root, flower and stem of *P. hysterophorus* and needle leachates of Pine leaves on the seed germination and early growth stages of Tulsi was evaluated at 1 %, 2%, 5% and 10% concentrations. The control group was given distilled water. It was found that all the four extracts of *P. hysterophorus* caused a general phytotoxic effect on seed germination and seedling growth on Tulsi at high concentrations. The inhibitory effect was pronounced at higher concentrations, whereas a little stimulatory effect was seen at lower concentrations in some cases. The inhibitory effect was more pronounced in root and flower extracts as compared to stem and leaf extracts. However, in case of Pine leachates, stimulatory effect was seen in all concentrations and germination was not inhibited even in higher concentrations. Thus, from this study, it can be conclusively established that *Parthenium* can render allelopathic action while Pine shows no such action on germination and growth of Tulsi.

Keywords: Allelopathy, leachates, aqueous, seedlings, germination

New locality record of Yellow-bellied House Gecko *Hemidactylus flaviviridis* Rueppell, 1835 (Reptilia: Squamata: Sauria: Gekkonidae), a potential biological controller, from Shikohabad, Firozabad district, Uttar Pradesh (India) with its systematic account, distribution and other aspects

AKHLAQ HUSAIN

41, Hari Vihar, Vijay Park, Chakrata Road, Dehra Dun, Uttarakhand, India

ABSTRACT

Hemidactylus flaviviridis, the Yellow-bellied House Gecko, belonging to family Gekkonidae, commonly found in North India but its locality records are meagre. Recently a good number of these geckoes were sighted by the author at Shikohabad (Firozabad district, Uttar Pradesh) which is not in records and hence the gecko has been reported here for

3rd International Conference on “Global Initiative in Agricultural, Forestry and Applied Sciences for Food Security, Environmental Safety and Sustainable Development (GIAFAS-2021)”

the first time from the area with its systematic account, distribution, habitat, food & feeding, breeding and trematode infestation.

They are also found to be the potential biological controllers as feed on various insect pests on gardens vegetation around and mosquitoes which fly out under light in night.

Keywords: New locality record, *Hemidactylus flaviviridis*, Shikohabad (Uttar Pradesh).

Novel bacteria for biological control of root-knot nematode, *Meloidogyne incognita*

Rami Kassam

Agriculture Department, Lattakia, Syria

ABSTRACT

Among microorganisms that parasitize nematodes or reduce nematode populations by their antagonistic behaviour, bacteria hold important position and some of them have shown great potential as biocontrol agents. The objective of this study has been to reinvestigate the local bacterial diversity across selected states of India that could be playing a key role in maintaining the natural balance of nematode population *vis-a-vis* to exploit the potential ones for their management. In the present study, soil samples were collected from 13 Indian states from rhizosphere of perennial trees, pulses, cereals, fruits and vegetables and used for isolating potential bacteria employing *Meloidogyne incognita* and *Caenorhabditis elegans* as baits in water agar. Isolation and purification of various bacteria revealed the presence of some predominant genera belonging to both plant pathogenic and non-pathogenic groups: *Alcaligenes faecalis*, *A. aquatilis*, *A. endophyticus*, *Burkholderia cepacia*, *B. ambifaria*, *Pseudomonas entomophila*, *P. mosselii* and *Pseudochrobactrum saccharolyticum*. All the bacteria were identified using 16S molecular markers. Evaluation of different dilutions of culture filtrates (CF) of various bacteria against *M. incognita* revealed their potential to kill juveniles and also inhibit egg hatching. GC-MS analysis of CF revealed the presence of nematicidal compounds such as Heneicosane, Myristinoyl pantetheine and Dimethyl disulphide in most of the bacteria. Further evaluation of these bacteria against *M. incognita* infecting tomato plants under green house conditions shown that some of them are highly promising to contain the nematode infection. Additional evaluation of these promising bacteria under field conditions will support commercial exploitation of the potential ones in future.

Keywords: *Alcaligenes*, *Burkholderia*, *Pseudomonas*, Heneicosane, Myristinoyl pantetheine, Dimethyl disulphide and *Meloidogyne incognita* biocontrol management.

New record of Six-spot Ground Beetle *Anthia sexguttata* (Fabricius, 1775) (Coleoptera : Carabidae), a biological pest controller, from Jehanabad, Bihar (India)

AKHLAQ HUSAIN¹ AND WAJID HASAN²

¹*41, Hari Vihar, Vijay Park, Chakrata Road, Dehra Dun, Uttarakhand, India*

²*Krishi Vigyan Kendra, Jehanabad, BAU, Sabour, Bihar, India*

ABSTRACT

The present communication deals with the new record of *Anthia sexguttata*, the Six-spot Ground Beetle, belonging to family Carabidae, from Jehanabad, Bihar (India). Their adults feed on agriculture pest mainly on soil and seeds of weeds etc. but they also sometimes ascend to vegetation around in search of their preferred food and hence are considered the beneficial predators as playing a major role in biological control of insect pests and unwanted weeds affecting the main crops in agricultural fields. Their larvae, which mostly subsist on pests in soil, also help in their control. In view of their importance a detailed account is provided here.

Key-words: New record, *Anthia sexguttata*, Jehanabad, Bihar.

Use of bacteria and fungi for control of soilborne seedling diseases of maize

Rambabu Dasi*, L. Nongdrenkhomba Singh, Bireswar Sinha, Nabakishor Nongmaithem, Pavani Paluru, Pooja Reddy, Kota Chakrapani

Department of Plant Pathology, College of Agriculture, CAU, Imphal

ABSTARCT

Biocontrol bacteria and fungi for seed treatment of maize is very useful and economical in present global conditions. Microorganisms can be exploited for their protective effects against soilborne infections by species of *Fusarium*, *Globisporangium* (syn. *Pythium*) and *Rhizoctonia* etc., The microorbes like bacteria and fungi from maize roots or other sources, including some active microbial components of commercial biocontrol products are effective for this. The majority of bacteria from maize roots are spore formers, most of the species of genera *Bacillus*, *Brevibacillus* and *Paenibacillus*. *F. culmorum*, have the similar level of control provided by seed treatment with the most efficacious bacterial and fungal isolates are comparable or close to the chemical reference seed treatment. The most effective bacteria are species of *Pseudomonas*, *Burkholderia* and *Streptomyces*. The most effective fungi are two strains of *Clonostachys rosea* and *Trichoderma*. *Trichoderma* and *Gliocladium virens* also protective against *R. solani*. The impact of seedborne *F. culmorum* can be controlled by seed treatment with *F. oxysporum* f. sp. *strigae*.

Key words: Biocontrol ,Bacteria, Fungi, Maize, Seedborne, Diseases

Biological control of tomato fruit borer, *Helicoverpa armigera* (Hubner)

N. Sunita Devi, Takhellambam Julia and Rimamay Konjengbam

College of Agriculture, Central Agricultural University Iroisemba, Imphal-795004, Manipur

ABSTRACT

Tomato (*Lycopersicon esculentum*) is one of the most popular vegetable crop of India but due to several biotic and biotic factors the productivity of tomato becomes low. Among biotic factors the crop is attacked by many insect pest and *Helicoverpa armigera* is one of the major insect pest of tomato. However, indiscriminate use of easily available synthetic chemical insecticides leads to negative impact on natural enemies, environment, their residues in harvested products leads to various health hazards. So, use of biological control is an alternative method by integrating with other pest management strategy to reduce the indiscriminate use of chemical insecticides. Biological control is the use of natural enemies to suppress the pest population. There are various biocontrol agents attacking *H. armigera*. Biocontrol agents includes predators, parasitoids and entomopathogens. Different natural enemies were taken in order to study their response to fruit borer infestation. The larvae of *Chrysoperla carnea*, especially the third instar have a good potential in controlling *H. armigera* eggs and 1st instar larva. Among different release of Trichogramma (16000, 14000, 12000 eggs t.c.) the minimum % infestation of *Helicoverpa* was observed in Trichogramma (16000 eggs t.c.) treated plot. It shows that trichogramma are very effective in managing *H. armigera* in field condition to control the pest below ETL. Among microbial insecticides Spinosad found to be most effective followed by HaNPV, *B. bassiana*, *V. lecanii*. At higher concentration of *B. bassiana* (1×10^9 spores ml⁻¹), all the strains showed higher degree of mortality of *H. armigera* larva. It was observed that all the treatments were superior over control. The study reveals that the combined effect of natural enemies can suppress the pest population and may be incorporated in developing IPM module for management of *Helicoverpa* in tomato.

Keywords: *Helicoverpa armigera*, Biological control, *Chrysoperla* sp., *Trichogramma* sp, *B. bassiana*

Discussion of some common fungal post harvest diseases of garlic in Manipur

Rimamay Konjengbam^{1*}, N Sunita Devi², Takhellambam Julia³ and Kota Chakrapani⁴

College of Agriculture, Central Agricultural University, Imphal West, Manipur

ABSTARCT

Post harvest diseases of vegetable crops not only hinder crop's productivity but also have crucial impacts on market value of the produce. Several post harvest fungal diseases have shattered marketability of the vegetable produce. Garlic

3rd International Conference on “Global Initiative in Agricultural, Forestry and Applied Sciences for Food Security, Environmental Safety and Sustainable Development (GIAFAS-2021)”

is one of the economically important rabi season spice crops in Manipur. Unfortunately, it suffers from various post harvest diseases. Black mould rot caused by *Aspergillus niger*, *Rhizopus* rot caused by *Rhizopus stolonifer* and blue mold caused by *Penicillium* species are common post harvest diseases of garlic. Post harvest clove rot of garlic caused by *Sclerotium rolfsii* is another emerging post harvest disease which had been reported from some market places in Manipur. Such post harvest diseases becomes prominent only after harvest during storage and transit. In Manipur, most of the small scale farmers and vegetable sellers suffered from heavy economic losses due to post harvest diseases since they lack adequate knowledge regarding post harvest pathogens and its management. Moreover, they cannot afford provisions and machinery necessary for avoidance of such diseases. Such diseases also confer harmful effects on human health. Hence, further works is considered very essential in regards to post harvest diseases of garlic as well as other vegetables in Manipur.

Keywords: Post harvest, disease, garlic, marketability, human health.

Effect of GA₃ on flower yield and quality of different varieties of perennial Chrysanthemum

Dipmala P. kedar* , Dipali Chatse, Dr. D. M. Panchbhai

Section. of Horticulture, Nagpur , Dr. Panjabrao Deshmukh Krishi Vidyapeeth, Akola (India)

ABSTRACT

A field experiment was conducted for observing the effect of GA₃ spray at 30th and 60th days after transplanting on yield and quality of four varieties of perennial chrysanthemum viz, Sonali Tara, Shubhra, Pandhri Rewadi, Piwadi rewadi. Application of GA₃ 150 ppm enhanced number of flower per plant obtained in shubhra with GA₃ 150 ppm and Yield of flower per plant (g), Yield flower per plot (kg) and yield of flower per ha. (q) in Piwadi Rewadi with GA₃ 150 ppm and also Diameter of fully opened flower (cm) and weight of fully opened flower (g), Diameter of flower disc (cm), Shelf life of flower (days) in variety of Piwadi Rewadi .

Key words- Chrysanthemum, GA₃, Different varieties, Yield and quality

Studies on insect pests of apple in Kashmir and its integrated management approaches

Shabir Davood Wani, Mohd Majid Jamali*, Rayees Afzal Mir & Dil Mahjoora Majeed

School of Agricultural Sciences, Glocal University, Saharanpur 247121, Uttar Pradesh, India

ABSTRACT

The present study was conducted during the year 2019-2020 in various apple orchards belonging to the southern region of the state of Jammu and Kashmir. The aim was to investigate the various insect pests of apple in Kashmir and its integrated management approach, during different phases, namely pre and post bloom, which spread during the months of March till the harvest stage in October. During survey a total of ten insect pests of apple with different orders were recorded i.e. San jose scale, Woolly apple aphid, Apple stem borer, Green apple aphid, Apple blossom thrips, Gypsy moth, Bark beetle, Tent caterpillar, Codling moth, Apple root borer. Among these pests, San jose scale damages all parts of the plant like leaves, flowers, stem, branches, roots, and fruits. While Woolly apple aphid and Apple stem borer cause serious damage to the apple nurseries.

Keyword: Apple, insect pest, integrated pest management, Kashmir.

Inference of Rock Phosphate, Phosphorous Solubilizing Bacteria and Lime on Phosphorous Content, uptake of P and Plant Dry Weight of Green Gram (*Vigna radiata* (L.) Wilczek)

Nakeertha Venu* , N. Surbala Devi, Laishram Nikita Devi and Hiren das

Department of Soil Science and Agricultural Chemistry, Central Agricultural University, Imphal, India,

ABSTRACT

Rock phosphate (RP) is one of the cheap sources of P but it cannot be used directly as a soil amendment due to its

extremely poor solubility in water (0.1%). However, the availability of Phosphorous from RP can be enhanced by applying it with lime and through the specific use of bio-inoculants. A pot experiment was conducted in the Department of Soil Science and Agricultural Chemistry, College of Agriculture, Central Agricultural University, Imphal during the *Pre-Kharif* season of 2021 to study Inference of Rock Phosphate, Phosphorous Solubilizing Bacteria and Lime on Phosphorous Content, Available P, uptake of P, Plant Dry Weight and yield of Green Gram (var. DGG-4). Results revealed that All the P treatments showed higher accumulation of Available P, Phosphorous content, Plant Dry Weight, P uptake and yield of green gram compared to control. Irrespective of different rock phosphate and PSB treatment combinations, application of lime increased available phosphorous, which in turn increased the phosphorous uptake and yield of green gram over the corresponding treatments without lime. Comparing among the treatments, maximum accumulation of plant P concentration, plant dry weight, uptake of P and yield of green gram were recorded in soil treated with T₁₀ (100% RD of P₂O₅ from RP + PSB₁ + PSB₂ + Lime (18.71t ha⁻¹) followed by T₉ = 100% RD of P₂O₅ from RP + PSB₂ + Lime (18.71t ha⁻¹). Combined application of PSB and lime enhanced solubilization of phosphorous from rock phosphate there by increasing plant uptake and yield of green gram.

Keywords: Rock Phosphate, Phosphorous Solubilizing Bacteria, Lime, P content and Plant dry weight

Effect of liming on nodulation in acid soil

Rupesh*, Jamkhogin Lhungdim, S. Mounika

Department of Agronomy, College of Agriculture, central Agricultural University, Imphal

ABSTRACT

Nutrient toxicity can occur in acid soils when pH is 4.8 or lower. In strongly acid soils, aluminium and manganese become more available in the soil solution and are harmful to plant roots. Acidic soils impedes nutrient and water uptake that results in decreased production. Roots are unable to grow effectively through acidic subsurface soil, which forms a barrier and restricts access to stored subsoil water for growth and grain filling. Soil acidity limits *Rhizobium* survival and persistence where elevated levels of aluminium have been shown to be directly toxic to the growth of Rhizobia affecting nodule initiation and the nitrogen fixation process. Liming is the application of calcium and magnesium rich materials in various forms, including marl, chalk, limestone, burnt lime or hydrated lime. In acid soils, these materials react as a base and neutralize soil acidity. As different study showed, that application of lime in acidic soil decreases toxicity of nutrient and increases different nutrient availability providing favourable environment for microbial growth. It also favoured root growth which helps for proper nutrient uptake and significantly increased number of nodules and nodular weight, which directly help in increasing crop yield.

Key words: Nutrient toxicity, Acidic soils, Lime, *Rhizobium*, Root growth

Phytoremediation of heavy metals by *Eichhornia crassipes*

Keisham Dony Devi, Th. Anupama Devi, L. Nabachandra Singh

Department of Agronomy, Central Agricultural University Imphal Manipur 795004

ABSTRACT

Excessive concentration of heavy metals is a major threat to ecosystem and can cause the water and soil contamination. Contaminants derived from anthropogenic activities can adversely affect wildlife and impact the human health wherein even low levels of contaminants in the environment pose a risk due to potential accumulation at higher trophic levels. The presence of heavy metals in water bodies is mainly due to the disposal of industrial wastes. Also, heavy metals appear as a result of environmental pollution due to the removal technology of mining, heavy traffic, smelting, manufacturing, and agricultural wastes in natural and agricultural areas. Phytoremediation is the use of plants and their associated microbes for cleaning up of contaminants present in the environment. This technology makes use of the naturally occurring processes by which plants degrade and sequester organic and inorganic pollutants. It is rapidly gaining interest and promises effective and inexpensive cleanup of hazardous waste sites contaminated with metals, hydrocarbons, and pesticides. Aquatic plants are mostly used for phytoremediation among which *Eichhornia crassipes* is quite common. It is a free-floating plant mostly considered as an aquatic weed. The optimum growth of *E. crassipes* was found in the temperature of 28°C to 30°C with a pH of 6.5 to 8.5. In view of wastewater treatment process, water hyacinth is an effective way of phytoremediation process as it is capable to treat heavy metal pollutants like lead, chromium wherein the root system of *E. crassipes* absorbs toxic compounds present in the wastewater. Research

showed that in *E. crassipes*, all trace elements accumulated to higher concentrations in roots than in shoots. Trace element concentrations in tissues and the bioconcentration factors (BCF) were proportional to the initial concentration of individual metal in the growth medium and the duration of exposure. Another study found that under 7 days *E. crassipes* showed the maximum removal efficiency of Chromium and Lead. *E. crassipes* was used for treating the industrial effluent (heavy metals accumulated) with the variation in combination of phytoremediation such as 10% and 20% and found that optimum percentage is 20% of *E. crassipes*. From a phytoremediation perspective, *E. crassipes* is a promising plant species for remediation of natural water bodies and/or wastewater polluted with low levels of Zn, Cr, Cu, Cd, Pb, Ag and Ni.

Keywords: Phytoremediation, heavy metals, *Eichhornia crassipes*

Review: Post-Harvest Disease Management of Citrus using bio-control measure

Mridupol Handique

Dept. Of Plant Pathology, Assam Agricultural University, Jorhat, Assam-13

ABSTRACT

Losses in fresh citrus fruits during post-harvest are increasing day by day. Most of them are caused by plant pathogenic fungi. These fungi can produce harmful mycotoxins which very much harmful for humans during consumption. Biological control of post-harvest decay shows some promising alternatives to chemical fungicides. Plant-based products along with natural and nature-based coatings are used extensively to control these pathogens. Study shows that plant-based chemicals while used with coatings show an increase in resistance against the post-harvest pathogens.

Different yeast species are showing promising antagonistic effects against these pathogens. Some important species are *Candida guilliermondii* (syn.: *Pichia guilliermondii*), *Pichia anomala*, *Candida saitoana*, *Candida famata*, *Candida oleophila*, *Candida sake*, *Aureo basidiumpullulans* and *Kloeckera apiculata* etc. Similarly some bacteria *Pseudomonas syringae*, *Ps. fluorescens*, *Burkholderia (Pseudomonas) cepacia*, *Bacillus subtilis*, *B. thuringiensis*, *Pantoea agglomerans*, *Enterobacter cloacae*, and *Serratia plymuthica* and fungi *Muscodor albus*, *Aureobasidium pullulans*, *Verticillium lecanii* are showing good antagonistic behavior towards post-harvest pathogen such as green and blue mold. These antagonists undergo antibiosis by secreting some chemicals which inhibit their growth and development in vitro.

GRAS chemicals are also showed some promising control measures. Some examples are sodium carbonate and bicarbonate, borax (E285, used as a food additive), sorbic acid etc. They have very less toxic to human so can be used for biocontrol measures against pathogens.

Aloe vera coatings are used as edible coatings are very much useful for disease control. Combine with natural plant products it can proved maximum protection to the post-harvest products.

Therefore, attempts have been made to use these bioagents in vivo to determine their efficacy towards pathogens. Combinations of these chemicals can increase the effectiveness.

Content of Zinc in Organic Sources as Influenced by Incubation of Zinc Sulphate

Sangya Singh^{*1}, G.S. Tagore², Shubham Singh³

¹JNKVV, Jabalpur, Madhya-Pradesh, India

²JNKVV, Jabalpur, Madhya-Pradesh, India

³RVSKVV, Gwalior, Madhya-Pradesh, India

ABSTRACT

Up-to- date husbandry normally entails the use of chemical fertilizers for conveying essential nutrients to crops. Not with standing, an fancy use of chemical fertilizers consequences in poor soil physical conditions and low microbial population which in flip has prejudicial effects on food of soil productivity. The use of incubated manures in addition to chemical fertilizers is, so, endorsed in multiple creating transnational sites for reaching sustainable food yield besides maintaining soil quality and terrain. The prime objective of this study was the effect of various organics incubated with zinc under controlled laboratory conditions at different days after incubation that is 30,45,60 and 90 days after

3rd International Conference on “Global Initiative in Agricultural, Forestry and Applied Sciences for Food Security, Environmental Safety and Sustainable Development (GIAFAS-2021)”

incubation for acknowledging the amount of zinc buildup in soil. Zinc sulphate heptahydrate was used for incubation of manures at the rate of 0, 2.5 and 5 kg Zn per hectare. The manures used were FYM, poultry manure, and vermicompost. To efficiently harness the nutrients from organic wastes, the mineralization potentiality of each organic emendation needs to be assessed and considered while deciding their usage.

The findings suggested that maximum total zinc content was found under poultry manure with 2.5 kg zinc per hectare at 60 DAI that is 203.59 mg per kg followed by FYM (117.61 mg per kg) and vermicompost with 2.5 kg zinc per hectare (78.52 mg per kg) at 60 DAI. Available zinc was found highest in poultry manure at 30 DAI with 5 kg zinc per hectare (41.25 mg per kg) followed by vermicompost with 0 kg zinc per hectare (35.29 mg per kg) and FYM with 5 kg zinc per hectare (32.42 mg per kg) at 90 DAI interval. Hence, appropriate manures should be chosen and applied in the proper quantity to provide exact amounts of nutrients, to increase crops nutrient use efficiency and to formulate correct fertilizer recommendations.

Keywords- Organic Sources, Zinc content, Zinc.

Motorized groundnut stripper : A cost effective post harvest technology

Rajeshwari Desai*, Geeta Chitagubbi and Shobha Kasar*****

All India Coordinated Research Project-Home Science (Family Resource Management)

Main Agricultural Research Station, University of Agricultural Sciences, Dharwad 580005,

ABSTRACT

The traditional method of groundnut stripping is an important post-harvest activity in which women are involved as the major labour force. It is laborious and time consuming and farm women are facing many health problems viz., body pain and blackening of palms. Even then farmers are facing difficulty due to shortage of labourers and also due to high labour wages. Manually operated strippers are developed and tested to reduce the drudgery of farm women, but still farmers are facing difficulty due to shortage of labourers and high labour wages. Hence, to reduce the drudgery while performing groundnut stripping activity, All India Coordinated Research Project-Home Science-Family Resource Management component of UAS, Dharwad has developed motorized groundnut stripper and evaluated it at the field level. Thirty non-pregnant farm women with normal health, and without any major illness or cardio-vascular problems, falling in the age range of 25- 45 years were selected for the study. The results showed that the machine is safe and easy to operate and is suitable for stripping of immediately harvested groundnut having the moisture content of 18-22 per cent. It also proved the excellence in work output with an average stripping rate of 2.64 Q/day as compared with other models and traditional method of hand stripping (0.84 Q/day). Further, 68 per cent of labour reduction was observed over traditional method. The farm women perceived using groundnut stripping machine made the work simple and light. They also experienced less drudgery as compared to traditional hand stripping and opined as a cost effective technology. Hence, such small improved and mechanized farm tools can be promoted among small and marginal farmers to reduce the drudgery and save the labour cost.

Keywords: *Drudgery, groundnut stripper, work out put, Cost of Operation and Man days*

Popularization of agricultural technologies for drudgery reduction and farm profitability

Rajeshwari Desai * Geeta Chitagubbi ** and Shobha Kasar***

All India Coordinated Research Project- Family Resource Management

Main Agricultural Research Station, University of Agricultural Sciences, Dharwad 580005,

ABSTRACT

Women play a significant and crucial role in agricultural development. They perform numerous labour intensive jobs such as weeding, hoeing, harvesting etc. They are following traditional methods to perform the farm activities, which are tedious and time consuming leading to drudgery of farm women. Hence to address to these problems, technological empowerment of women with improved farm tools is the need of the day. Hence, the study was conducted with an

3rd International Conference on “Global Initiative in Agricultural, Forestry and Applied Sciences for Food Security, Environmental Safety and Sustainable Development (GIAFAS-2021)”

objective to bring farm machinery within the reach of small and marginal farmers by popularizing the use of small agricultural tools and technologies. The trainings on popularization of farm tools were conducted in different villages namely Sulla, Surshettikoppa villages from Hubli taluk and Marewad and Kotur villages from Dharwad taluks and about 200 farm women were trained. The pre & post knowledge tests were executed before and after the training programmes. The results revealed that the farm women had less knowledge regarding improved technologies. The post test scores revealed that farm women had maximum knowledge gain with respect farm mechanization. Thus, such trainings on improved tools/implements & machinery empowers the rural women with technical knowledge and enhances the farm profitability by reducing the labour cost.

Key word: *Impact assessment, Popularization, Drudgery, Farm profitability, Pre and post tests*

Evaluation of diverse wheat genotypes for heat stress tolerance using correlation and path coefficient analysis

Kavita, Mukesh Kumar

Department of Genetics and Plant Breeding, CCS Haryana Agricultural University, Hisar (125004), India

ABSTRACT

Terminal heat stress is the major stress that affects the flowering and grain-filling stages in wheat crop. Selection of better genotypes for adaptive traits could increase their performance under this heat stress. In order to understand the relationship and contribution of sixteen traits towards the grain yield under normal and high temperature stress conditions, the association and path coefficient analysis were studied in fifty diverse bread wheat genotypes. These field experiments were done in the arrangement of RBD replicated two times at Wheat and barley research farm, CCSHAU Hisar in 2019-20. The data collected from the experiment was used to analysis of correlation and path coefficient. The study of correlation suggested that productive tillers/meter, spike length, grains per spike and biological yield per plot were the most essential characters which possessed positive and highly significant phenotypic correlation (0.721-0.882) with grain yield. The phenotypic analysis of path coefficient indicated that harvest index and biological yield showed highest positive direct effect (0.526 and 0.971 respectively) on grain yield. Therefore, from these studies the important traits which possessed positive association and direct effect on grain yield have been reported. These studies suggest that the biological yield and harvest index per plot can be used as selection standards in breeding program to improve bread wheat genotypes with high yielding under stress condition.

Keywords: Wheat, Terminal heat stress, Correlation Path coefficient

Intregrated nutrient management

Jay Nath Patel*¹, Mohd Shah Alam¹, Durgesh Kumar²

¹Department of Agriculture, Sardar Vallabhbai Patel University of Agriculture & Technology, Modipuram, Meerut-250110, (U.P.), India.

²Department of Vegetable Science, Chandra Shekar Azad University of Agriculture & Technology, Kanpur, (U.P.), India

ABSTRACT

The use of combination of chemical fertilizers, organic manures and bio-fertilizers for the nutrition of crop plants is referred as the Integrated Nutrient Management (INM). The aim of INM is to improve and maintain the physical, chemical, biological and hydrological properties of the soils to enhance soil fertility and productivity with minimizing the land degradation. Alleviation of poverty and achievement of zero-hunger target and food security can be achieved by the INM; in fact it has the bright solution in this area. Replacement of a part of chemical fertilizers application by organic manure and bio-fertilizers is practices for INM by simple technique. INM resulted in balanced nutrition to the crops and better nutritional uptake lead to better plant growth and yield. INM minimizes the deterioration of soil, water

3rd International Conference on “Global Initiative in Agricultural, Forestry and Applied Sciences for Food Security, Environmental Safety and Sustainable Development (GIAFAS-2021)”

and ecosystem by promoting carbon sequestration, reducing nutrient losses to ground and surface water bodies and to atmosphere. It also reduces the cost of fertilizer application to the crops, which is helpful to the farmers in crop production. Thus, INM is necessity of crop nutrition for improving and maintaining the various soil properties with its fertility and productivity along with greater crop yield production with better quality traits and maintains satisfactory profit.

Role of market access for food and nutrition security in India

Subodh Agarwal

Department of Business Management, CCSHAU, Hisar, Haryana, 125004.

ABSTRACT

Global food demand is increasing rapidly, its expected to reach 9.1 billion in 2050 and over 10 billion by end of the century. There are several factors for food scarcity but the food producers play an important role to meet the food demand and needs motivation by providing them good value of their agricultural produce. This will require major changes in agricultural policies. Lack of market access and nutritional insecurity continue to affect large no of people in the world. Majority of the farmers are small and marginal they don't have direct access to the market and are dependent on middleman as a result their share (producers share) in consumers rupee is very small. The global rate of under nourishment decreased significantly in past 7 years around 11% and according global nutrition report (2018) 46.6 million children were stunted and 25.5 million children were deceased alone in India. The per capita availability of food alone is not sufficient; equally important is the balanced diet or nutritional diet to meet their dietary needs and food preferences for an active and healthy life. The four major components of food security are food availability, access to food, utilization and its stability. These components can be sstrengthen by good governance, apt policy, capacity development of our local markets, majority of which are driven by small farmers. This could be implemented for poverty reduction, smallholder inclusion and increased food & nutrition security. It helps the farmers to cultivate and harvest fresh edible products round the year, if their produce is systematically marketed with proper value chain and value addition it will be benefit for both farmers and consumers in terms of market value and access to healthy and nutritious food respectively. The globalized world with market reforms will allow these farmers to sell their produce to world market too, offering them optimum price, which will help in their inclusive development. Such policies will definitely help in fulfilling the sustainable development goal, end-hunger, achieve food security and improved nutrition and promote sustainable agriculture.

Effect of Post Harvest Technology in Increasing Shelf life of Rose (*Rosa hybrida*) cv. Mainu Parle

Punam Horo^{1*}, Raimani Hembrom², Aruna Murmu³ and Arti Kumari⁴

Department of Horticulture, Ranchi Agriculture College, Birsa Agricultural University, Kanke Ranchi-834006 Jharkhand

ABSTRACT

Roses are recognized for their high economic values which give quick returns as a fresh cut flower. However the main idea of rose plant cultivation is to get the cut flower which greatly deals with the floricultural business. Flower is highly perishable in nature. Its freshness can be increased through the reserved food contains. Under normal conditions, cut roses last only for a few days maintaining their beauty and attractiveness. Turgidity of cut stem depends on water absorption, water loss through transpiration and ability of stems to retain water. By using appropriate preservatives

could help to extend the vase life. Keeping in view an experiment was conducted at Department of Horticulture, Birsa Agricultural University Kanke, Ranchi. The design of experiment was CRD, consisted of eight treatments, with different holding solution of Bleaching powder, Sucrose, Al₂SO₄ (300 ppm), Brine Solution, GA₃, Sodium benzoate and distilled water. Vase life (6.56 days), Final Flower Diameter (6.46 cm) and Total water absorbed (48.56 ml) was maximum in T₇ ie Sucrose (4%) + Al₂SO₄ (300 ppm) while minimum vase life, final flower diameter and Total water absorbed (3.36 days, 3.16 cm and 20.66 ml respectively) was found in T₈ ie control. The minimum bacterial count (1.00 cfu/ml) in T₇ ie Sucrose (4%) + Al₂SO₄ (300 ppm) and maximum in T₈ (control) ie distilled water followed by the treatment T₃ (brine solution 2.5%).

Key words: Rose, Post-harvest Studies, Vase life of Flower.

Impact of Microbial Consortia on Plant Attributes and Nodulation in Soybean

Shubham Singh^{*1}, N.G. Mitra², R.K. Sahu³, Sangya Singh⁴

¹ RVSKVV, Gwalior, Madhya-Pradesh, India

² JNKVV, Jabalpur, Madhya-Pradesh, India

³ JNKVV, Jabalpur, Madhya-Pradesh, India

⁴ JNKVV, Jabalpur, Madhya-Pradesh, India

ABSTRACT

In the present investigation entitled “Impact of microbial consortia on plant attributes and nodulation in Soybean” was carried out during *Kharif* 2019-20 in the experimental field, Department of Soil Science, College of Agriculture Jabalpur (M.P.). The experiment was laid out under randomized block design (RBD) with 3 replications having 16 treatments (T1 to T16) comprising different combinations as consortia of *Rhizobium* sp., *Bacillus* sp., *Streptomyces* sp., *Rhodospseudomonas* sp., *Lactobacillus* sp., *Saccharomyces* sp. and fungi (*Aspergillus* sp.) along with fertilized uninoculated control (FUI) and unfertilized uninoculated control (UFUI).

Result of the study revealed that the microbial consortium T14 performed best for the observations at 25, 45 and 65 DAS whereas plant height & its biomass are also taken at harvest increases by 92.28, 42.77, 44.59 & 43.49 and 48.17, 45.78, 63.25 & 61.45% over FUI; Nodule enumeration and its biomass by 70.16, 57.68 & 82.99 and 48.98, 37.14 & 39.40% over FUI. Similarly, leghemoglobin content in nodule at different growth stage (25, 45 and 65 DAS) was estimated highest by the application of consortia of bioinoculant T14 along with percent increment 46.83, 51.29 & 50.49% over FUI. Therefore, it can be conclude that the co-inoculation on seeds with bioinoculants in different consortia might plausibly influence to the crop through direct and indirect mechanisms *viz.*, enhancing diazotrophy, nutrient solubilization, siderophore formation for Fe availability, excretion of growth promoting enzymes (IAA, GA, ABA, cytokinin, *etc.*), anti-oxidants against phytopathogens, ACCD activity for vigorous plant growth, systemic resistance, enhancement of the protein and RNA synthesis.

Key words- *Rhizobium*, *actinomycetes*, *consortia*, *growth*, *leghemoglobin*, *soybean*.

Effect of agronomic practices on green house gases emission in paddy field

SAITHALA MOUNIKA*, EDWIN LUIKHAM, RUPESH GANJARE

Department of Agronomy, College of Agriculture, Central Agricultural University, Imphal

ABSTRACT

Rice is world's most staple food. Several aspects of rice have been studied to increase its production; however, environmental aspects, including impact on climate change, have not been studied well. So, the discussion on Water management, Tillage practices, fertilizer application for development of adaptation strategies for rice GHG emission

3rd International Conference on “Global Initiative in Agricultural, Forestry and Applied Sciences for Food Security, Environmental Safety and Sustainable Development (GIAFAS-2021)”

reduction. Carbon dioxide (CO₂), methane (CH₄), and nitrous oxide (N₂O) are the top three GHGs, accounting for 64%, 17%, and 6%, respectively, of the total radiative forcing which increase cause by anthropogenic emissions. Developing and disseminating mitigation options are urgent need. CH₄ and nitrous oxide (N₂O) emissions were compared among three treatments of water management: continuous flooding (CF), AWD, and site-specific AWD (AWDS). The total water use, resultant global warming potential (GWPs) significantly reduced by AWD and AWDS compared to CF. The seasonal cumulative CH₄ emission was significantly reduced by AWD'S compared to CF, whereas the seasonal cumulative N₂O emission and grain yield did not differ among three treatments. No significant differences in the measured items between AWD and AWDS. So, AWD's performance confirmed as mitigation option for paddy GHG emission. Agricultural tillage practices study four tillage systems consisting of no-tillage with no fertilizer (NT0), conventional tillage with no fertilizer (CT0), no-tillage with compound fertilizer (NTC) and conventional tillage with compound fertilizer (CTC) were compared in terms of the carbon dioxide (CO₂), methane (CH₄) and nitrous oxide (N₂O) emissions. Tillage and fertilization had no influence on CO₂ emissions. Higher CH₄ emissions and lower N₂O emissions were observed in CTC than in NTC. There was no significant difference in N₂O emissions between NT0 and CT0 systems, but significant in CH₄ emissions. GWP of CTC was 12% higher than NTC, therefore our findings show that no-tillage system was an effective strategy to reduce GWP from rice. Studied the impact of organic and inorganic fertilizers on emission levels of carbon dioxide (CO₂), methane (CH₄) and nitrous oxide (N₂O). The results of the study indicated higher rate of emissions from chemical fertilizers than organic fertilizer. Therefore the use of organic fertilizers was recommended.

Key Words : GHG Emission, Paddy field, Water management, Tillage practices, fertilizer application

Recent advances in sustainable management of Maize Sheath Blight

Paluru Pavani*, L. Nongdrenkhomba Singh, Bireswar Sinha, Nabakishor Nongmaithem, Rambabu Dasi, Pooja Bathula

Department Of Plant Pathology, College Of Agriculture, CAU, Imphal

ABSTRACT

Maize (*Zea mays* L.; 2N=20) is major staple food crop grown worldwide adapted to several biotic and abiotic stresses. Maydis leaf blight (MLB) and banded leaf and sheath blight (BLSB) are serious foliar fungal diseases may cause up to 40% and 100% grain yield loss, respectively. Maize has a wide adaptability to diverse agro-climatic conditions around the world. Maize was introduced to India in the beginning of 17th century. It is now one of the important crops in India occupying fifth place in area and third place in production. Among various diseases of maize, banded leaf and sheath blight caused by most widespread, destructive and versatile pathogen *Rhizoctonia solani* f. sp. *sasakii* has attained the status of economically important disease. It has become an increasingly severe and economically important disease of maize in several countries of Asia. The disease is favored by hot and humid conditions. Efforts to manage the disease through chemicals have not been successful. Stripping of lower 2-3 sheaths from ground level when the crop is 35-40 days old has been found to check disease spread significantly. The disease is difficult to control through either fungicides or crop rotation alone due to its soil borne nature and unavailability of resistance source. This disease causes direct loss due to premature death of early infected plants and stalk breakage and ear rot in the older plants. Losses in grain yield to the extent of 11 to 40 per cent under favorable conditions have been reported due to banded leaf and sheath blight.

Keywords: Banded leaf, sheath blight, *Rhizoctonia solani* f. sp. *sasakii*, *Zea mays*, fungicides.

Genetic assessment of newly developed maize inbreds for yield and its attributes in different agro-climatic conditions

***Gaurav Sharma¹, Uttam Chandel², Sawan Kumar¹ and Satish Kumar Guleria³**

¹Department of Genetics and Plant Breeding, CSK Himachal Pradesh Agricultural University, Palampur, Himachal Pradesh, India

3rd International Conference on “Global Initiative in Agricultural, Forestry and Applied Sciences for Food Security, Environmental Safety and Sustainable Development (GIAFAS-2021)”

²CSKHPKV, SAREC, Kangra, Himachal Pradesh, India

³CSKHPKV, HAREC, Bajaura, Himachal Pradesh, India

ABSTRACT

Maize is a strategically important crop for the millions of resource-poor farmers because of its multiple uses as food, feed and raw material for industry. The detailed genetic assessment of germplasm derived new elite lines is pre-requisite for future breeding programmes. The present study was undertaken to determine the combining ability of newly derived maize inbred lines over the environments. Twenty eight crosses developed by crossing eight inbred lines in half diallel mating design, were evaluated in RBD at two environments representing different agro-climatic and ecological conditions of North-Western Himalayas (SAREC, Kangra and HAREC, Bajaura). Data was recorded for various agromorphological traits during *Kharif*, 2019. Analysis of variance indicated sufficient amount of genetic variability in material. Bartlett's test revealed that error variance was homogeneous only for six traits out of total twelve traits. Estimates of σ^2 SCA were higher as compared to σ^2 GCA in both the environments and in pooled over environment as well, except for the days to 75% brown husk in Kangra which indicated preponderance of non-additive gene action. The inbred line B-73 in Bajaura, pooled over environment and LM-14 in Kangra were found good general combiner for most of the traits. The crosses B-73 \times BAJIM-1811 and BAJIM-1522 \times BAJIM-1811 in Kangra, Bajaura as well as in pooled over environment identified as the potential hybrids. The inbred lines with good GCA may be utilized as potential parents for development of high yielding single cross maize hybrids. The crosses identified as potential hybrids may be commercially exploited after critical evaluation for its superiority in performance and with stability across the locations over years.

Key words: General combining ability, genetic variance, maize, specific combining ability

Occupational health hazards of workers in small scale enterprises

Kiran Bala¹ & Wineet Chawla²

Assistant Professor^{1&2}

Department of Agriculture, Baba Farid College, Bathinda, Punjab.

ABSTRACT

Small-scale enterprise is a business that employs a small number of workers and does not have a high volume of sales. Such enterprises are generally privately owned and operated sole proprietorships, corporations or partnerships. The legal definition of a small-scale enterprise varies by industry and country. E.g. Basic Metal Industries, Metal Products, Electrical Machinery & Parts, Rubber & Plastic Products. Occupational health and safety (OHS) relates to health, safety, and welfare issues in the workplace. OHS includes the laws, standards, and programs that are aimed at making the workplace better for workers, along with co-workers, family members, customers, and other stakeholders. Improving a company's occupational health and safety standards ensures good business, a better brand image, and higher employee morale

Occupational health and safety is concerned with addressing many types of workplaces hazards, such as: Chemicals, Physical hazards, Biological agents, Psychological fallout. Joykutty (2017) concluded that, in manufacturing industry especially, Bangalore both the public and private sectors are functioning effectively towards safety and health on workforce. Discussing best practices, asking questions, and learning from each other will help improve safety and prevent loss of life.

Anatomical and physiological basis of resistance against downy mildew in pearl millet (*Pennisetum glaucum* (L.) R. Br.)

Sarah Murria^{1*}, Namarta Gupta¹, Nirmaljit Kaur¹, Ruchika Bhardwaj² and Anju Bala²

¹Department of Botany, Punjab Agricultural University, Ludhiana, 141004

²Department of Plant Breeding and Genetics, Punjab Agricultural University, Ludhiana, 141004

ABSTRACT

Exploitation of host plant resistance knowhow is the watchword of every agriculturist in the developing and developed countries. A thorough understanding of the downy mildew tolerance mechanism operating in pearl millet inbred lines is essential to develop varieties with durable and stable resistance. The present study was conducted to decipher variable response of highly resistant (HR) and highly susceptible (HS) inbred lines to downy mildew at the experimental area of Forage, Millet and Nutrition Research Farm, and the laboratories of Department of Botany, Punjab Agricultural University, Ludhiana. The reaction of pearl millet inbred lines was evaluated to downy mildew disease development on the basis of physiological, anatomical and biochemical attributes as the indicators for downy mildew tolerance in pearl millet. For this, one highly susceptible (PIB 1614) and one highly resistant (PIB 1910) pearl millet inbred line was selected for understanding the mechanism of disease resistance. The plants of selected pearl millet inbred lines were raised and downy mildew (*Sclerospora graminicola*) infestation occurred naturally under field conditions. Field evaluation of pearl millet inbred line PIB 1614 which is highly susceptible to downy mildew exhibited 93.37% disease incidence, whereas inbred line and PIB 1910 exhibited 0.00 *per cent* disease incidence during *Kharif* 2019 and 2020. The disease intensity was severe in PIB 1614 with 0.88 disease severity index (DSI) with complete destruction of the plant due to formation of green ear i.e. the transformation of floral structures into leaf like structures. The data on the photosynthetic gas exchange variables recorded for healthy and downy mildew infected flag leaves of both the selected inbred lines depicted significant differences among the selected inbred lines. The defense mechanism was initiated by the host plant in response to *S. graminicola* infestation. The infestation caused an increase in internal CO₂ concentration, decrease in net photosynthetic rate, stomatal conductance and transpiration rate of the flag leaf. The stomatal size was higher in HS inbred line (PIB 1614) whereas the stomatal index was higher in HR inbred line (PIB 1910). Also, the plugging of stomatal pores and vascular bundles with an increase in trichome density was observed post infection. Further evaluation of transverse sections of leaves of HR and HS inbred lines indicated presence of highly compact spongy mesophyll and visibly denser trichomes in HR inbred line conferring resistance. The chlorophyll a, chlorophyll b and total chlorophyll were higher in healthy leaves as compared to the infected ones. The pigments were higher in resistant inbred line than in susceptible one. The total soluble sugar and MDA content was higher in HS inbred line whereas total phenols, starch and enzymatic activities *viz.*, POD, PPO and IAAO were higher in HR inbred line. The present study thus provides information for elucidating the factors that might associate resistance of pearl millet cultivars against downy mildew and could aid in development of DM resistance associated to assist future crop breeding programmes of the cultivars resistant to the disease

Biological Control of *Aphis craccivora* (Koch) with predaceous ladybird, *Hippodamia variegata* (Goeze)

Pratibha Awasthi and Ahmad Pervez

Biocontrol Laboratory, Department of Zoology, Radhey Hari Govt. P.G. College, Kashipur, – 244713 (India);

Abstract:

In the present investigation, adult male and female of a predaceous ladybird beetle, *Hippodamia variegata* were used for the biocontrol of cowpea aphid, *Aphis craccivora* (Koch). We determined functional response parameters in terms of attack rate and prey handling time along with the functional response curve by following CATMOD and NLIN procedures using SAS. We found that this ladybird attack the aphid population of increasing density by increasing its feeding potential, exhibiting a Type II functional response. Female ladybird has a greater coefficient of attack rate

3rd International Conference on “Global Initiative in Agricultural, Forestry and Applied Sciences for Food Security, Environmental Safety and Sustainable Development (GIAFAS-2021)”

(2.624 ± 0.196) than the male ladybird (1.921 ± 0.493). The prey handling times in terms of attacking, subduing, consuming and digesting each aphid was lesser in adult female (10.07 ± 0.63 min) than the male ladybird (14.17 ± 0.52 min). This shows that female ladybirds are better potential biocontrol agents than the male ones. It could be concluded from the results that this ladybird may be recommended for effective biocontrol of aphid, *Aphis craccivora*.

Key words: Coccinellidae, *Hippodamia variegata*, *Aphis craccivora*, ladybirds, aphids, Functional response

Effect of heavy metal stress on photosynthesis and respiration of plant

Manjulata Palei¹ and Ranjan Kumar Sahoo*

¹Department of Biotechnology, Centurion University of Technology and Management, Bhubaneswar, Odisha, India

*Department of Biotechnology, Centurion University of Technology and Management, Bhubaneswar, Odisha, India

ABSTRACT

It is well known that plant photosynthesis and respiration are two basic and important physiological processes, while the vital role of the antioxidant system in reacting to abiotic factors is still a focal point for investigating physiological stress. Several studies suggest that the battle against toxicity of heavy metal balancing includes complex processes at the genetic, biochemical, physiological, cellular, tissue, and whole plant levels that may manifest themselves in terms of improved productivity of crops. Heavy metals have adverse effects on plant development and metabolism. Photosynthesis is very vulnerable to heavy metal toxicity, and both in vivo and in vitro photosynthetic CO₂ fixation affects heavy metals. Most of the elements studied are inhibitory to photosystem (PS) II, and PS I is less sensitive in isolated chloroplasts. A typical site of action appears to be the oxidising side of PS II. Potential sites of inhibition also involve photophosphorylation of enzyme activity. Inhibition in vivo appears to be due to multiple effects of these metals. Stomatal closure is the immediate consequence, followed by chloroplastic changes. Long-term exposure results in decreased leaf development, decreased photosynthetic pigments, chloroplast structure, and decreased activity of CO₂ assimilation enzymes. Like other metabolic processes, some enzymes that require metals as cofactors catalyse cell respiration, while higher concentrations of these metals and other non-essential metals inhibit enzyme activity. Higher heavy metal concentrations are less affected by dissimilation process enzymes than energy fixation and carbon assimilation pathway enzymes.

Keywords: Heavy metal stress, antioxidant system, elevated CO₂, photosynthesis, respiration

Recent advancements for energy production and sustainable environment in anaerobic digestion technology

P. S. Bandgar^a, Sudhir Jain^b and N. L. Panwar^c,

^{A,b,c} College of Technology and Engineering, Maharana Pratap University of Agriculture and Technology, Udaipur (RJ), India – 313001

ABSTRACT

Recent advances in a renewable biogas production process have resulted in the latest progress in using biogas as the alternative energy source to conventional sources of energy. Scientific efforts in the past decades have largely focused on improving and developing sustainable bioprocess solutions for energy recovery. As a low-price organic waste-treating technology with simple installation and relatively low capital and operational expenses, anaerobic digestion (AD) has been developed. These technologies have widely reported their viability and achievement and demonstrated the superiority of two-stage AD over single-stage AD as regards the total energy retrieval from biomass under various substrates and temperature levels, and in pH settings. However, co-digestions, electro co-digestion, various pre-treatments (physical, chemical, biological or combined), the addition of bio-based carbon materials, bioaugmentation have been applied to enhance the biogas production as per the various organic waste materials. Therefore, the selection of appropriate advanced technologies for particular biowaste gives better performance for biogas production. Furthermore, biogas contains undesirable components such as moisture, sulphide hydrogen (H₂S), carbon monoxide (CO) and carbon dioxide (CO₂). To remove these contaminants, different biogas upgrading processes have been

3rd International Conference on “Global Initiative in Agricultural, Forestry and Applied Sciences for Food Security, Environmental Safety and Sustainable Development (GIAFAS-2021)”

developed such as water scrubbing, amine scrubbing, pressure swing adsorption and membrane division. And, separation of biogas digestate in solid and liquid through electro dialysis reversal and forward osmosis are attractive among membrane technology because of their high membrane trapping resistance. The information provided could help researchers to select the appropriate recent advances in AD technology to achieve the best results of biogas production and performance.

Keywords: Anaerobic digestion, biogas, recent technologies, digestate, sustainable development etc.

Ergonomic Assessment of Occupational Hazards among Dentists of Uttarakhand: A Descriptive Study

¹Garima Pant and ²Deepa Vinay

¹Department of Family Resource Management, College of Home Science, GBPUAT, Pantnagar, U.S. Nagar, Uttarakhand, India

² Department of Family Resource Management, College of Home Science, GBPUAT, Pantnagar, U.S. Nagar, Uttarakhand, India

ABSTRACT

Dentists are known to have occupational health issues, including dental threats of a physical, environmental, chemical and psychosocial type. The poor medical outcomes with occupational health issues include musculoskeletal disorders (MSDs), eye injuries, vibration neuropathy and neurological problems. Problems such as contact dermatitis, hearing loss and irritation from dental products were also observed. Dental workers in the dental school and functional sector have a number of challenges including a range of occupational health threats as well as hazards such as the reactions of infectious diseases, pollution and vibration, as well as allergies to dental products. This study was conducted to assess occupational hazards among the dental surgeons of Uttarakhand. Among the study group of 80 dentists, 54 were males and 26 were females. Descriptive cross sectional survey was conducted using a self-administrated questionnaire. The study reveals that mean percentage scores were found maximum in the area of ‘psychological hazards (90 %), followed by 72.70 per cent in the area of ergonomic hazard, 45.93 per cent in accidental hazard and only 1.67 per cent in the area of ‘physical hazard’. The chances of occupational hazards are more common in dentists. Almost all the private dental practitioners were suffering from the occupational hazards. Back problems were common. Regular training and workshops can help lower such problems.

Keywords: Dentists, Occupational hazards, Occupational health, WMSD, Prevalence, psychological hazards

Moisture conservation for timely sowing of wheat in *rabi* season under rainfed conditions

¹Vishal Sharma*, ²Arvind K. Ishar, ³Suraj Parkash, ⁴Parul Gupta, ⁵Rohit Sharma ⁶Ajay Gupta and ⁷Vishal Mahajan

^{1,7}Krishi Vigyan Kendra- Kathua, SKUAST-Jammu, INDIA

^{2,3,4}Krishi Vigyan Kendra- Rajouri, SKUAST-Jammu, INDIA

⁵AMFU, RARS, Rajouri

⁶Krishi Vigyan Kendra- Poonch, SKUAST-Jammu, INDIA

ABSTRACT

Wheat is cultivated in about 40 thousand hectare with production and productivity of 62784 quintals and 15.70 quintals/ha, respectively in Rajouri district. Wheat (*Triticum aestivum*) is the second most important staple food crop

after maize. Wheat-Maize being the sole cropping sequence which is the most prominent crop rotation in the district. However, weather is a critical factor influencing the production of crops in this region. Being rainfed, timely rainfall in district viewed as a dominant climatic element influencing timely sowing and ultimately the yield of wheat crop. The frequent dryspells during the sowing time greatly influence the crop productivity and become the limiting factor to achieve potential productivity. Hence, to overcome with untimely rainfalls at the time of sowing of wheat crop as experienced in last few years an experiment was formulated to study the effect of In-situ conservation of *kharij* moisture for timely sowing of wheat in *Rabi* season under rainfed conditions in the form of On Farm Trials (OFTs) during *Rabi* 2017-18 and 2018-19 and conducted at five locations in each season. The experiment comprised of 3 treatments: T1- Farmer practice (Sowing after rainfall), T2- After harvest plough and heavy planking, T3- After harvest plough and heavy planking + Mulching with maize straw. Results indicated that the integration of plough and heavy planking with maize straw mulching was more effective in timely sowing of wheat crop during untimely rainfalls. Combination of after harvest plough and heavy planking + Mulching with maize straw resulted in significantly higher yield of Wheat (26.86 q ha⁻¹) as compared to after harvest plough and heavy planking alone (25.20 q ha⁻¹) and farmer practice (23.48 q ha⁻¹). Adoption of improved sowing technology increased yield by 12 per cent over farmers’ practices. The economical parameters indicated that net profit of ₹25754 ha⁻¹ was recorded with treatment T3 over farmer practices ₹ 21833 ha⁻¹. Benefit cost ratio for after harvest plough and heavy planking + Mulching with maize straw and farmer practice was 1.95 and 1.82, respectively.

Key words: Wheat, rainfall, mulching, conservation technology

Influence of date of sowing on the development of Alternaria blight, 1000 seed weight and seed yield Oilseed Brassica

C.S. Choudhary*, Md. Minnatullah², Anjana Arun¹, S. P. Singh², R.S. Singh, Vikram Bharati, A. K Mishra, U. Mukherjee and Anil Pandey

Tirhut College of Agriculture, Dholi, Muzaffarpur (Dr. RPCAU, Pusa, Samastipur, Bihar), India

Abstract

To find out most suitable date (s) for sowing of the oilseed brassica crop for maximum yield and least Alternaria blight disease incidence, a trial was carried out in field condition at Tirhut College of Agriculture, Dholi, Muzaffarpur in Split Plot Design. Seeds of mustard variety, Varuna and Yellow Sarson (66-197-3) were sown at 6 different dates at seven days interval viz. October 15th, October 22th, October 29th, November 5th, November 12th, and November 19th during *Rabi* 2018-19. The results indicated that the crop sown on October 15th, recorded lowest per cent disease Intensity (PDI) of 45.92 per cent in cultivar Varuna and 64.44 per cent in cultivar 66-197-3 and crop sown on October 29, i.e. normal dates of sowing, favoured quick Alternaria blight development and recorded highest 57.03 and 80.74 per cent disease intensity in cultivar Varuna and 66-197-3 respectively. The 1000 seed weight of cultivar Varuna were varied in between 3.0 g. to 4.0 g. and 2.43 g. to 3.20 g. in cultivar 66-197-3 amongst the different dates of sowing. Highest seed yield of Varuna (1440 kg/ha) and 66-197-3 (856.7 kg/ha) was recorded when crop was sown timely on 29th October. The temperature from 9.3 to 26.5^oC and relative humidity 84.19 to 99.61% during above mentioned seasons apparently favoured disease development. Multiple regression equation between disease index and weather variables exhibited strong relationship among the different components of epiphytotics during the season and indicated that the combined effect of different weather variables favoured the disease development causing upto 81 per cent variation in the disease severity of cultivar Varuna and upto 84 per cent variation in the disease severity of cultivar 66-197-3.

Keywords: Oilseed brassica, fungal diseases, Alternaria blight, dates of sowing

Assessment of elite and ISH genotypes for resistance to sugarcane red rot disease

Md. Minnatullah¹, Shiva Pujan Singh¹, C.S. Choudhary², Anjana Arun³ and Aaradhna¹

1 SRI, RPCAU, Pusa

2 TCA, Dholi, RPCAU, Pusa

3 VKSCOA, Dumraon, Buxar

ABSTRACT

Sugarcane supports one of the largest agro-processing industries of the country, it generates considerable employment in the agriculture sector and related activities. Sugarcane is extensively cultivated in tropical and sub-tropical regions of the country. The average productivity of sugarcane in Bihar is 60.15 tonnes/ha against the national productivity of 76.99 tonnes/ha. In India, it is cultivated in an area of 5.20 million ha. of land with production of 400.37 million tonnes. In Bihar, it is covered the area of 3.04 lakh ha. of land with a production of 182.85 lakh tonnes/ha. Red rot disease of sugarcane caused by *Colletorichum falcatum* is a dreadful disease which is difficult to manage through chemicals. The disease causes considerable losses both in yield and juice quality. The reduction in cane weight, juice content and recovery of jaggery varied according to the levels of disease infection. In yield (30-100%) and in sucrose (25-75%) were observed by Tiwari et al, 2010. Development of resistant varieties against this disease is the cheapest and appropriate way of solution which can be achieved by testing of clones to identify the source of resistance. For this an experiment was conducted at SRI, RPCAU, Pusa research farm during 2019-20 and 2020-21 cropping seasons. On the basis of observations, twenty seven elite and ISH sugarcane clones were artificially evaluated for resistance to red rot with CF07 and CF08 isolates by plug method of inoculation. Out of which, six clones (IGH 829, ISH 513, IGH 554, IGH 833, ISH 502 and ISH 545) were found resistant, four clones (IGH 834, ISH 594, ISH 585 and ISH 590) were found moderately resistant, two clones (IGH 816 and ISH 519) were moderately susceptible and remaining fifteen clones were observed susceptible to CF07 isolate. Whereas, seven clones (IGH 829, ISH 513, IGH 834, ISH 554, ISH 594, IGH 833 and ISH 502) were observed resistant, three clones (ISH 585, ISH 590 and ISH 545) were found moderately resistant while, two clones (ISH 512 and ISH 519) were found moderately susceptible and rest fifteen clones were found susceptible to isolate CF08.

Keywords: Sugarcane, Assessment, ISH, Genotypes, Red rot disease

Mapping of Soil Macro and Micro Nutrients by GIS in Jalgaon district (M.S.)

¹*Monika Naphade, ²G. S. Sidhu, ³V. D. Patil, ⁴Ritu Thakare.

¹Dr. Ulhas Patil College of Agriculture, N.H. No. 6, Jalgaon–Bhusawal road, Jalgaon Khurd,

²College of Agriculture, Guru Kashi University, Talwandi Sabo,

³Vasantrao Naik Marathwada Krushi Vidhyapith, Parbhani,

⁴Mahatma Phule Krushi Vidhyapith, Rahuri,

ABSTRACT

A study was conducted to assess available macro and micro nutrient status of soils of Jalgaon District by GIS technique. Total 450 soil samples (0-22.5 cm) drawn during 2019-2020 from the 15 Tahsils of Jalgaon district of Maharashtra. The soil samples were analyzed for their fertility status and mapped by geographic information system (GIS) technique. The exact locations of soil samples were recorded with the help of GPS. Samples were analyzed for soil pH, electrical conductivity, organic carbon content, calcium carbonate content, available macro nutrients viz. N, P, K, S, and micronutrients like Fe, Zn, Cu and Mn. Soil pH of the Jalgaon district varied between 6.79 to 8.85 with an average of 7.74, while, electrical conductivity was 0.14 to 2.38 dSm⁻¹, showing slightly acidic to alkaline nature of soil and most of the soils are safe in total soluble salt content. Organic carbon content was very low to very high (2.35-25.80 g kg⁻¹) and soils are non-calcareous to highly calcareous (1.25-184.76 g kg⁻¹) in nature. The average nitrogen content (210.76 kg ha⁻¹) shows the soils are medium in nitrogen availability. The phosphorus was low to medium (4-162 kg ha⁻¹), however, wide spread deficiency of P is noticed. The soils are rich in potassium (653.58 kg ha⁻¹). The average sulfur content (13.43 kg ha⁻¹) shows the soils are low in sulphur availability. Available iron and zinc content was low to medium (0.12-85.4 and 0.20-3.4 mg kg⁻¹, respectively) while, copper and manganese content was sufficient (1.88 and 25.42 mg kg⁻¹, respectively). Soils are becoming saline and sodic in some part of Jalgaon district. The area of phosphorus deficiency is increasing. The fertility maps developed are useful for proper management of fertilizers by the farmers of Jalgaon district. Further, the use of GPS-GIS based technique for soil sampling is new land mark, which will enable the further researchers and University Officials to monitor the changes in soil fertility status for years to come.

Keywords: Macronutrients, Micronutrients, Soil fertility maps, GPS-GIS technique.

Determination of the Physiological effect of workers on linseed thresher

Meera kumari

RPCAU, PUSA , Bihar

ABSTRACT

Ergonomic evaluation of linseed thresher operated by selected operators of different age groups at three different weight sample of linseed were carried out in the field of Agricultural Engineering (Department of Farm Machinery and Power Engineering), Vaugh Institute of Agricultural Engineering and Technology, Sam Higginbottom University of Agriculture Technology and Sciences, Prayagraj, Allahabad. Physiological parameters, heart rate, oxygen consumption rate and energy expenditure rate of age group operators of (20-24, 25-29, 30-34, 35-39 and 40-44 years) were determined during working on linseed thresher at different moisture level of sample of linseed crop. Heart rate, oxygen consumption rate and energy expenditure rate were increasing when age groups increased at moisture level of sample (15%, 20%, 25% MC). Heart rate, oxygen consumption rate and energy expenditure rate of 20-24 years age groups were found minimum during working on thresher at different moisture levels. Heart rate, oxygen consumption rate and energy expenditure of age group operator of 40-44 years were found maximum as same.

Keywords: Ergonomic, Linseed crop, Physiological, Parameter and Moisture level.

Soil organic carbon pools variability in the different agro-climatic conditions of Bihar

Sunita Kumari Meena, Ajeet Kumar, Md. Minnatullah, Shiv Pujan Singh

Sugarcane Research Institute, RPCAU, Pusa

ABSTRACT

In agro-ecosystems, soil organic matter plays many important roles contributing towards functions like sustaining biological activity along with improving nutrient availability and crop productivity and environmental quality. Better crop management practices including incorporation of organic sources of nutrients have the potential to reduce the CO₂ concentration in atmosphere through carbon sequestration by soils and ultimately improving soil health and quality. A study was undertaken to explore and analyze the soil health of different districts of Bihar. So, present investigation was carried out, by collecting soil samples from surface soil (0-15 cm) from the Gangatic Plain Banka and Sitamarhi districts of Bihar for soil organic carbon fractions and other physico-chemical parameters determination. The study region mainly has considered rice-wheat cropping system. Based on the 73 composite soil samples chemical properties of Banka and Sitamarhi districts have been analysed. Results showed that soil reaction varied from slightly acidic to alkaline in reaction. Meanwhile, available cationic micronutrient (Fe, Zn, Cu, Mn) ranges low -to- high in concentrations. Percent contribution of different SOC pools to the total SOC followed as non Labile (47 and 49%), Very Labile (26 and 24%), Labile (18 and 19%) and Less Labile (9 and 8%) in Banka and Sitamarhi, respectively.

Keywords: Carbon pools, rice-wheat cropping system, ecosystem.

Response of Early Sugarcane (*Saccharum officinarum* L.) Genotypes under varied NPK levels and row arrangement in subtropical climates of Bihar.

Lalita Rana, Navnit Kumar and A.K.Singh

Sugarcane Research Institute, Dr. Rajendra Prasad Central Agricultural University, Pusa, 848 125, Samastipur, Bihar, India

ABSTRACT

A field study was implemented during spring season (2020-21) with the objective of assessing the response of early sugarcane (*Saccharum officinarum* L.) genotypes under varied fertilizer levels and row arrangement in subtropical climates of Bihar. The design of the experiment was factorial randomized block design replicated thrice. Treatments include 8 genotypes (CoLk15466, CoP 15467, CoP 15436, CoSe15452, CoSe15455, CoLk 94184, CoSe 95422, CoSe 01421), two (2) row spacing i.e. 90 cm and 120 cm and two (2) NPK levels include 100 % and 125 % RDF.

3rd International Conference on “Global Initiative in Agricultural, Forestry and Applied Sciences for Food Security, Environmental Safety and Sustainable Development (GIAFAS-2021)”

Recommended dose of fertilizer was 150:85:60 Kg N, P₂O₅ and K₂O/ha. The soil was sandy loam in texture. All agronomic management practices were performed during the experiments. The results of the study revealed that genotype CoP 15436 produced the highest millable canes and cane yield followed by CoSe15452. Higher plant population (1, 51,600/ha), plant height (294.5 cm), millable canes (1, 17,500/ha) and cane yield (80.2 t/ha) of sugarcane were observed when planted at 90 cm spacing. However, the brix, pol and purity percent juice was found non-significant. The maximum plant population (1, 47,400/ha), plant height (301.8 cm), millable canes (1, 13,800/ha) and cane yield (82.3 t/ha) was obtained with 125 % NPK levels of recommended dose of fertilizer while varied fertility levels did not significantly influenced the brix, pol and purity percentage. Thus it can be concluded that Genotype CoP15436 performed better at 90cm row spacing and 125 % fertility level followed by CoSe15452 and CoLk 15466.

Use of ICT Among Rural Farmers in Agricultural Development

Kumari Shipra,

Dept. of Home Science Extension and Communication Management, RPCAU, Pusa

ABSTRACT

Information and Communication Technologies (ICTs) are any devices, tools that permit the exchange or collection of data through interaction or transmission. ICT is an umbrella term that includes radio, television, mobile phone, internet, electronic money transfer, etc., The ICTs increase productivity, access to markets and adaptability to weather conditions in agriculture. More effective interventions are needed in agriculture because rising food prices pushed over 40 million people in to poverty since 2010 (World Bank 2011). The growing global population which is expected to reach 9 billion by 2050, has heightened the demand for food and placed pressure on already- resources. Feeding that population will require a 70 per cent increase in food production (FAO 2009). Even after years of industrialisation and growth in services, agriculture still accounts for one-third of the gross domestic product and three-quarter of employment in sub-Saharan Africa. Over 40 per cent of the labour force in countries with per capita incomes in the US\$ 400 to 1,800 range works in agriculture (World Bank 2008) . The information and Communication Technology (ICT) can revolutionize Indian farming sector and can benefit all farmers including small landholders. Agriculture is the most important sector with the majority of the rural population in developing countries depending on it. The traditional approaches of agriculture being adapted, has numerous challenges in terms of production, marketing, profit etc. The challenges of the traditional agriculture are addressed significantly by using Information and Communication Technologies (ICT) that play an important role in uplifting the livelihoods of the rural small landholder farmers. ICT helps in growing demand for new approaches. It also helps in empowering the rural people by providing better access to natural resources, improved agricultural technologies, effective production strategies, markets, banking and financial services etc. ICT promises a fundamental change in all aspects of our lives, including knowledge dissemination, social interaction, economic and business practices, political engagement, media, education, health, leisure and entertainment. ICTs can play a significant role in combating rural and urban poverty and fostering sustainable development through creating information rich societies and supporting livelihoods. If ICTs are appropriately deployed and realize the differential needs of urban and rural people, they can become powerful tools of economic, social and political empowerment.

Standardization of protocol for genomic DNA extraction in *Fraxinus xanthoxyloides* a cold desert species grown in Western Himalayas

Akshit Kukreti^{1*}, Manisha Thapliyal², Neelam Kurmanchali^{3*} and Laxmi Rawat⁴

^{1,2} *Silviculture and Forest Management Division, Forest Research Institute, Dehradun, Uttarakhand, India*

³ *Department of Agriculture, Doon Business School, Dehradun, Uttarakhand, India*

⁴ *Plant Pathology Division, College of Forestry, Ranichauri, Uttarakhand, India*

ABSTRACT

A top-notch genomic DNA extraction is an important imperative for a number of molecular and genome based studies. In the present study, a new and optimized protocol has been developed based upon the conventional cetyl trimethylammonium bromide (CTAB) method with further modifications for the isolation of genomic DNA from a cold

3rd International Conference on “Global Initiative in Agricultural, Forestry and Applied Sciences for Food Security, Environmental Safety and Sustainable Development (GIAFAS-2021)”

desert least concern shrub/small tree Afghan ash (*Fraxinus xanthoxyloides*) containing high amount of secondary metabolites such as, phenols, alkaloids, polyphenol and polysaccharides. The modifications were made for DNA extraction involved the use of, 4% cetyltrimethyl ammonium bromide (CTAB), 4% polyvinylpyrrolidone (PVP) and 0.3% β -mercaptoethanol in the extraction buffer. The incubation period of the extraction buffer was also magnified from 45 minutes to 60 minutes at 58°C. The following modifications in the present method establish an easy and quick method for genomic DNA extraction and it will be useful for assessing the genetic diversity of *F. xanthoxyloides*. Whereas, the population structure of *Fraxinus xanthoxyloides* is poorly known, and no informative molecular markers for the species are available. *Fraxinus xanthoxyloides* stand needs to be conserved due to its narrow distribution range, prone to genetic depletion or extinction following habitat destruction. In India, the species is little known except in high Himalayan regions, where it is used mainly by the locals, graziers and the tribals for fodder and medicinal purpose.

Keywords: CTAB, *Fraxinus xanthoxyloides*, Molecular techniques, PVP, DNA

Use of some organic and biofertilizers with partial substitution for the mineral fertilization of maize

Huda M. M. Elmasry

ABSTRACT

Mineral fertilizers are commonly used to improve soil fertility and plant nutrition, but the sole use of chemical fertilizers is causing deterioration in soil physico-chemical and biological properties, moreover, is toxic to animal, plants as well as for human life. Hence, it was necessary to develop alternative methods to supplying nutrients to the growing plant. Organic and bio-fertilizers are considered as a promising alternative approach for maize and other crop species production.

Two field experiments were carried out to study the effects of nitrogen application level (control, 90, and 120 kg N/fed) and five treatments (control, K- humate, vinasse, bio-fertilizer and vinasse + bio-fertilizer) on growth, yield and its components as well as chemical constituents of maize plants. The results indicated that raising mineral nitrogen fertilizer level from 90 to 120 kg N/fed. resulted in significant increases in all parameters under study. Vinasse treatment under application of nitrogen fertilizer levels had a significant effects on plant height, leaf area, protein, carbohydrates, NP- content in grain and leaves, grain k- content, yield and its components, than the treatments of K- humate, bio-fertilizer or vinasse + bio-fertilizer, in both seasons.

Through this study, it can be recommended to use vinasse with the addition of nitrogen fertilizer at a rate of 90 kg N/fed could reduced 30 kg N/fed which contributes to saving production costs by reducing the amount of chemical fertilizer addition and to minimizing the environmental pollution as well as minimize the harmful effect of nitrogen on human life.

Key words: Bio-fertilizer, K- humate, Nitrogen fertilizer, Vinasse, Yield, Zea mays.

Current conditions and impacts of climate change - Policies and ways to limit the impacts

N.MEENAKSHI*, A.SRILATHA AND DR.RENUKA.S.SALUNKE

Dept. of Family Resource Management, College of Community Science, UAS, Dharwad, Karnataka - 580005

ABSTRACT

Climate change is a broad range of global phenomena created predominantly by burning fossil fuels, which add heat-trapping gases to Earth's atmosphere. These phenomena include the increased temperature trends described by global

3rd International Conference on “Global Initiative in Agricultural, Forestry and Applied Sciences for Food Security, Environmental Safety and Sustainable Development (GIAFAS-2021)”

warming, but also encompass changes such as sea-level rise, ice mass loss in Greenland, Antarctica, the Arctic and mountain glaciers worldwide, shifts in flower/plant blooming and extreme weather events. The Intergovernmental Panel on Climate Change (IPCC) forecasts a temperature rise of 2.5 to 10° F over the next century. Global annually averaged surface air temperature has increased by about 1.8°F (1.0°C) over the last 115 years (1901–2016). Global average sea level has risen by about 7 to 8 inches since 1900, with almost half (about 3 inches) of that rise occurring since 1993 and are expected to continue to rise by at least several inches in the next 15 years and by 1 to 4 feet by 2100. In 2013, the daily level of carbon dioxide in the atmosphere surpassed 400 parts per million for the first time in human history. Average air temperatures in the region have increased by about 5°C over the last 100 years. Oceans are already experiencing large scale changes at a warming of 1°C, with critical thresholds expected to be reached at 1.5°C and above. Coral reefs are projected to decline by a further 70-90% at 1.5°C. At a warming of 2°C virtually all coral reefs will be lost. Ocean oxygen levels are projected to decrease by as much as 3.5% under the higher scenario by 2100 relative to pre-industrial values. Since the early 1980's, annual average arctic sea ice has decreased in extent between 3.5% and 4.1% per decade, has become thinner by between 4.3 and 7.5 feet, and is melting at least 15 more days each year. September sea ice extent has decreased between 10.7% and 15.9% per decade. Sea levels are expected to rise between 10 and 32 inches (26 and 82 centimeters) or higher by the end of the century. Vanishing ice has challenged species such as the Adelie penguin in Antarctica, where some populations on the western peninsula have collapsed by 90 percent or more. The study draws information about the latest agreements and policies such as Addis Ababa Action Agenda, Financial Stability Board, Financial Stability Board, Taskforce on Climate-related Financial Disclosures Report, MDB's, Global Infrastructure Hub, Global Infrastructure Facility, Mission Innovation, Renewable Energy Platform for Institutional Investors, The Carbon Disclosure Project (CDP), NDC Partnership, 2050 Pathways Platform, which are formulated to reduce the existing levels to protect the future generations from further destruction.

A REVIEW OF THE SIGNIFICANCE OF MICROORGANISMS IN BIOREMEDIATION

Akrati Dey, D.K. Dwivedi and N. A. Khan

Department of Plant Molecular Biology & Genetic Engineering Acharya Narendra Deva University of Agriculture & Technology, (Kumarganj), Ayodhya-224229 (U.P.), India

ABSTRACT

Microorganisms are extensively dispersed across the biosphere due to their amazing metabolic ability and ability to flourish in a broad range of environmental circumstances. Microorganisms' nutritional flexibility can also be used for pollution biodegradation. Bioremediation is the word used to describe this type of procedure. It is carried on based on the capacity of specific microbes to convert, alter, and use harmful substances in order to produce energy and biomass. Bioremediation is a microbiological well-organized systematic activity that is used to break down or convert contaminants to less harmful or non-toxic elemental and compound forms rather than just collecting and storing them. Bioremediators are biological agents that are employed in bioremediation to clean up polluted areas. Bacteria, archaea, and fungus are examples of primary bioremediators. The use of bioremediation as a biotechnological method using microorganisms to solve and remove the risks of numerous pollutants from the environment through biodegradation. The terms bioremediation and biodegradation are more interchangeable. Microorganisms are important pollutant removal tools in soil, water, and sediments, owing to their advantages over other remediation procedures. Microorganisms are repairing natural environments and avoiding future pollution. The goal of this study is to describe current trends in the application/role of microorganisms in bioremediation and to add important background that has been recognised as a need in this topic area. It is currently a popular study field since microorganisms are eco-friendly and offer valuable genetic material for solving environmental problems.

Keywords: bioremediation, bioreactors, pollution, microorganisms, degradation

Cytoplasmic genetic male- sterility system in pearl millet and exploitation of heterosis

Naveen Sihag¹, Dr. Dev Vart Yadav¹

Chaudhary Charan Singh Haryana agriculture university, Hisar, Haryana

ABSTRACT

3rd International Conference on “Global Initiative in Agricultural, Forestry and Applied Sciences for Food Security, Environmental Safety and Sustainable Development (GIAFAS-2021)”

Pearl Millet [*Pennisetum glaucum* (L.) R. Br.], also known as Bajra, is a coarse C4 cereal grown in tropical semi-arid regions of the world. It is well adapted to production systems characterized by low rainfall, low soil fertility, and high temperature, and thus, can be grown in areas where other cereal crops, such as wheat or maize, would not survive. It is also one of the most drought resistant crops among cereals and is rich in iron and zinc, contains high amount of antioxidants and considered as a beneficial food for the overall health and wellbeing. Pearl millet is a highly cross-pollinated crop due to its protogynous nature and has commercially exploitable cytoplasmic-nuclear male-sterility systems. A sterile cytoplasm coupled with different nuclear backgrounds affects the expression of many agronomic and disease traits. Extensive use of a single CMS source not only narrows the cytoplasmic diversity but also potentially exposes the hybrids to vulnerability of disease and insect pest epidemics. Different qualitative and quantitative characters are known to be influenced by cytoplasmic genes. Cytoplasmic as well as nuclear diversification of parents of hybrids is important for improving yield and resistance to biotic and abiotic stresses. Cytoplasm has an important role to play in the manifestation of heterosis and combining ability of elite inbred lines used in hybrid breeding. Potential utility of such lines in breeding programmes, particularly with reference to heterosis and combining ability of cytoplasmically diverse hybrids is critical in improving the precision and efficiency of hybrid breeding.

Chemical Composition and Utilization of Forest Fruits: A Review

Kusum Meghwal^a, Deep P Patel^a, Jain SK^b, Arun K^c

^{a,b}*Department of Processing and Food Engineering, College of Technology and Engineering,*

^c*Department of Dairy & Food Chemistry, College of Dairy & Food Technology,*

Maharana Pratap University of agriculture and Technology, Udaipur, Rajasthan, India, 313001

ABSTRACT

About 9 per cent of the Indian population is represented by tribal communities, who have been traditionally living in the forests, collecting minor forest products for their livelihood. There are many tree species having significant economic uses, which are either under severe neglect or the cultivation is restricted to a small region. Realizing the advantages of these species, attempts have been made to popularize the cultivation of forest plants by several international and national organizations. Among them, a few species have performed exceedingly well by competing even with traditionally grown local crops and have provided sustainable income to farmers. Some of the forest fruit trees which have gained prominence in recent years in India are Tamarind (*Tamarindus indica*), Custard Apple (*Annona squamosa*), Bael (*Aegle marmelos*), Indian Gooseberry (*Emblica officinalis*), Ber (*Zizyphus mauritiana*), Jackfruit (*Artocarpus heterophyllus*) and Kokum (*Garcinia indica*). Considering the situation of poor people who are dependent on agriculture and deprived of employment opportunities, the Government of India has been focusing on promotion of special agricultural development packages to promote sustainable livelihood for these small holders. However, it is extremely difficult for small farmers to compete with large farmers whose cost of production is significantly lower due to superior quality land and well established infrastructure. Therefore, there is good opportunity for small farmers to take up cultivation of new and forest crops which can be sold easily, while generating additional income. With small scale production, it is also easy to find good market for lesser known products.

Agriculture, Pesticides, Food Security and Food Safety

Rohtash Kumar¹, Jasveer Singh² and Pradeep Kumar³

1. *Agriculture Extension, Choudhary Charan Singh Haryana Agricultural University, Hisar*

2. *Sam Higginbottom University of Agriculture, Technology and Sciences, Prayagraj*

3. *Agricultural Economics, Swami Keshwanand Rajasthan Agricultural University, Bikaner*

3rd International Conference on “Global Initiative in Agricultural, Forestry and Applied Sciences for Food Security, Environmental Safety and Sustainable Development (GIAFAS-2021)”

ABSTRACT

Decades ago, agrochemicals were introduced aiming at enhancing crop yields and at protecting crops from pests. Due to adaptation and resistance developed by pests to chemicals, every year higher amounts and new chemical compounds are used to protect crops, causing undesired side effects and raising the costs of food production. Eventually, new techniques, including genetically modified organisms (GMOs) resistant to pests, could halt the massive spread of agrochemicals in agriculture fields. Biological chemical-free agriculture is gaining also more and more support but it is still not able to respond to the need for producing massive amounts of food. The use of agrochemicals, including pesticides, remains a common practice especially in tropical regions and South countries. Cheap compounds, such as DDT, HCH and lindane, that are environmentally persistent, are today banned from agriculture use in developed countries, but remain popular in developing countries. As a consequence, persistent residues of these chemicals contaminate food and disperse in the environment. Coordinated efforts are needed to increase the production of food but with a view to enhanced food quality.

Keywords: **Population growth, Pesticide residues, Persistent organic pollutants (POPs), Food production, Food safety**

FOOD SECURITY IN DEVELOPING COUNTRIES SAKSHI GOYAT

ABSTARCT

Agriculture, food security, nutrition and health are fundamentally linked, with the issues of food quantity and food quality being pivotal. While lack of energy is generally an issue only in highly food-insecure areas, micronutrient malnutrition is much more widespread and pervasive. As problems of insufficient and poor quality food persist, changes in the global environment are creating new emerging nutritional issues such as the “nutrition transition”—a process by which globalization, urbanization and changes in lifestyle are linked to excess energy intake, poor quality diets, and low physical activity which lead to rapid rises in obesity and chronic diseases even among the poor in developing countries. Other major long-wave challenges currently pressuring agriculture-nutrition-health pathways include the AIDS epidemic in Africa, climate change and environmental degradation. Yet despite these linkages and processes, agriculture and health policies and programmes tend to remain locked in sectoral silos, rarely integrated with each other. Agricultural policies address natural resource management, farmers' livelihoods, food security, and food safety—while public health policies revolve around the provision of prevention and curative care within clinic-based health systems. Agriculture is driven by an economic development rationale, while health aims to maximize human development. At the interface—and usually falling through the cracks—lies nutrition.

Keywords - NUTRITION, FOOD SECURITY

Evaluation of food grains for preparation of spawn for cultivation of *Calocybe indica* Dibakar Panda^{1*} and Mohan Kumar Biswas²

Department of Plant Pathology, Institute of Agriculture, Visva Bharati, Sriniketan-731236

ABSTRACT

Popularities of mushrooms is because of attractive texture and delicious taste, among the cultivated mushrooms milky mushroom has ability to grow in higher temperature and is also considered to be alternative of non veg foods for vegetarians. In India, some part of the country holds good promise towards the cultivation of milky mushroom, for fast growth of mycelium or easy cultivation this experiment is mainly focused on evaluation of yield and yield contributing characteristic of milky mushroom (*Calocybe indica*). Pure culture of milky mushroom procured from Tropical Mushroom Research Centre, OUAT, Bhubaneswar and was maintained on PDA medium. Different food grains for

3rd International Conference on “Global Initiative in Agricultural, Forestry and Applied Sciences for Food Security, Environmental Safety and Sustainable Development (GIAFAS-2021)”

preparation of spawn viz., wheat grain (*Triticum aestivum*), paddy grain (*Oryza sativa*), bajra grain (*Pennisetum glaucum*) and sorghum grain (*Sorghum bicolor*) were used. In the present work, it is found that the spawn prepared by using bajra grain produces the average maximum yield i.e., 1340g with the biological efficiency of 134.0%.

Keywords: bajra grain, biological efficiency, *Calocybe indica*, pure culture, spawn substrates.

Importance of Indigenous Technical Knowledge

Naaz Bano, Neelam Kumari and Rajesh Dahiya

Department of Extension Education and Communication Management, CCS HAU, Hisar

ABSTRACT

Indigenous Technical Knowledge (ITK) has enormous potential for innovation in the field of education, especially at the grassroots level. India is a country inhabited by a number of indigenous communities, most of which have their own set of unique traditional knowledge and technology. Many of these knowledge and technologies are combined with the modern knowledge and technology system and have been provided the indigenous communities with comfort, ease and self-sufficiency. These traditional technologies and knowledge have played a considerable role in the overall socio-economic development of the communities. Such knowledge and technologies are collectively owned, developed over several generations and subject to adaptation, and imbedded in a community as means of survival. Within the wide framework of indigenous knowledge, the contribution of ITK is remarkable. This knowledge plays very important role in many grassroots innovations. Such knowledge is responsible for improvement in countless important rural enterprises such as poultry. Regardless of the wide recognition of indigenous peoples' contribution to the world's biological diversity, cultural and sustainable development, a lot of challenges still remain in the area of traditional knowledge and technologies. In case of traditional societies, the local indigenous individuals are the major actor. In many cases, the indigenous communities are not well aware about the value of their indigenous knowledge which has been passing from generation after generation. Actors such as NGOs and scientific institutions could play important role in this regard for capacity building among the indigenous communities and popularization of traditional techniques and methods. In today's context, there is an urgent need to popularize and evaluate indigenous innovation. There should be a appropriate collaboration between indigenous knowledge and modern knowledge. Such type of coalition is occurring in some of the sectors such as ethnomedicine. The same should happen to all other sectors also so that the contributions of the indigenous innovators properly reach the society.

Keywords: ITK, Traditional Technologies, Indigenous Knowledge, Communities, indigenous innovators

ATTITUDE OF FARM WOMEN TOWARDS INDIGENOUS TECHNICAL KNOWLEDGE (ITK) WITH EMPHASIS ON AGRICULTURE AND ALLIED FIELDS

PRITISHRI PARHI¹, ¹Professor, HDFS

Department of Human Development and Family Studies, College of Community Science, Odisha University of Agriculture and Technology, Bhubaneswar- 751 003

ABSTRACT

In an attempt to know the status of ITK in the context of 21st Century Agriculture, it was thought proper to study the attitude of women folk, who are living either in forest area or close to forest ecosystem, definitely with manifestation of characteristics of rural community in their own way in all possible dimension. This is because, not generally observed that the women folk are relatively more active in agricultural field than their male counter part, which is the scenario of all tribal districts across the state.

Accordingly, with above context and background, Mayurbhanj district was purposively selected which is coming under the North Central Plateau Zone, out of the 10 agro-climatic zone of Odisha, and out of the 7 agro-ecological situations, low elevation medium rain fall area was also selected purposively. However, out of 14 blocks coming under the AES, Udala, Baripada, Betanati blocks were selected randomly, but the respondents from Santala tribe were selected purposively by following snowball technique for interviewing / discussing with the individual respondents with the help of local interpreter. An attitude scale was administered for the purpose, which is specifically developed for the study. It

3rd International Conference on “Global Initiative in Agricultural, Forestry and Applied Sciences for Food Security, Environmental Safety and Sustainable Development (GIAFAS-2021)”

was found that the respondent farm women shown, highly favourable attitude towards ITK to the extent of 60%, and moderately favourable attitude to the extent of 25%, and only 15% shown unfavourable attitude, when the obtained attitude scores were computed and analysed. This is again an encouraging situation, when entire world is shouting in favour of sustainable development in a clean, green, safe and secured environment.

Keywords: ITK, Santal, Women folk, Agriculture

Nanotechnology in crop protection

Shivani Suman and Naveen

Department of Entomology, College of Agriculture, Rajmata Vijayaraje Scindia Krishi Vishwa Vidyalaya, Gwalior, Madhya Pradesh, India

ABSTRACT

Nanotechnology is a concept in science and technology that has grown in popularity over the previous decade. Nanotechnology research takes advantage of the unique behaviour of materials and structures (nanomaterials) with dimensions of 1–100 nm. Because of the huge surface area of nanoparticles, their mechanical and physical properties differ significantly from those of larger-size bulk materials (or individual atoms and molecules). This approach is used in a wide range of industries, including chemical, agriculture, medical, and cosmetics are among them. Despite the obvious benefits of nanoparticles, there is concern about their safety for humans and the environment, necessitating new safety rules for this technology. Many insecticides on the market today are organic chemicals that are water insoluble. Regular use of these products causes organic solvent contamination in the environment, as well as insufficient activity and insect resistance. Nanotechnology appears to be a promising solution to these issues. While the insecticide molecule is not altered chemically, forming the material as nanoparticles may result in a large increase in water solubility, resulting in a faster dissolving rate and improved dispersion uniformity when applied. Although nanoparticle production is very expensive, it is very likely that this technology will become more widely used in the near future. The frequent use of pesticides has led to the development of disease and pest resistance, the accumulation of chemical residues and pollution. Therefore, alternative methods are needed to control pests and pathogens. Nanotechnology can bring benefits to pesticides, such as: Reduce the toxicity of poorly soluble pesticides, extend the shelf life, increase solubility, and have a positive impact on the environment.

Keywords: Nanotechnology, nanomaterials, human safety, shelf life, persistency, solubility, eco-friendly.

IMPACT AND APPROACH OF FRONT LINE DEMONSTRATION OF LENTIL (*LENS CULINARIS* MEDIK.) CROP IN SARAN DISTRICT, BIHAR

SURENDRA PRASAD*, R. K. JHA, A. K. SINGH, VIJAY KUMAR, PANKAJ KUMAR, S. S. PATEL AND J. C. CHANDOLA

KRISHI VIGYAN KENDRA, MANJHI, SARAN

Dr. Rajendra Prasad Central Agricultural University, Pusa, Bihar

ABSTRACT

The conducted front line demonstration (FLD) on lentil (*Lens culinaris* Medik.) crop in Saran during Rabi season 2010-11 to 2012-13. The main focused on increased productivity and replacement of old variety and adaptation of new high yielding improved variety KLS-218. The data revealed that whole season these variety was superior over traditional variety use by farmer's practices. The average of three years data observed lentil yield 11.96q/ha by used of production technologies on high yielding variety and local farmer's variety 08.84 q/ha. The performance of this variety was increased 35.12% over farmer's variety. The economic and yield influence of lentil by production technology over farmer's practices i.e. benefit cost ratio (2.91:1) over farmer's practices (2.22:1) and technology gap (3.04 q/ha), extension gap (3.12 q/ha) and technology index (20.29%). During this period was significant increased in knowledge level and satisfaction of farmer's.

Key words: Front line Demonstration, Lentil, Pulses, yield gap and B:C ratio.

A STUDY ON EXPLORATION OF SOIL QUALITY OF THE AGRICULTURAL SOIL OF LUDHIANA DISTRICT, PUNJAB (INDIA)

Priyanka Sharma¹, Jatinder Kaur Katnoria²

*Department of Botanical and Environmental Sciences,
Guru Nanak Dev University, Amritsar (Punjab)-143005, INDIA*

ABSTRACT

Soil, an important natural resource on the earth's surface and is one of the key elements to sustain life on earth. Fertile soils contribute to the productivity and sustainability of the agriculture. Some inadequate activities such as application of chemical fertilizers and pesticides as well as direct discharge of untreated effluents have exacerbated soil degradation resulting in a decrease in soil productivity. Heavy metal pollution in soils is a serious environmental problem as these are the non-biodegradable pollutants. Expanding industrial areas, mine tailings, disposal of high metal wastes, animal manures, sewage sludge, and pesticides have been the main source of heavy metals in the soil. These activities are not only removing critical nutrients from the soil but also contributing soil pollution on account of heavy metals and other pollutants. Considering the harmful effects of deteriorated soil quality, the present study was planned to evaluate physico-chemical parameters and genotoxicity of three agricultural fields of Ludhiana, India by employing *Allium cepa* root chromosomal aberration assay. Soil samples were collected from 3 villages viz., Raian, Walipur khurd and Bhudewal. Soil samples were analyzed for different physico-chemical characteristics like pH, alkalinity, chlorides, nitrates, phosphates, sodium, and potassium. The soil samples were found to be slightly alkaline (7.76 – 8.5). Soil nutrients such as potassium (K), chloride (Cl), calcium (Ca) and sodium (Na) range from: (0.05 – 0.18 mg/g), (0.18 – 0.21 mg/g), (0.86 – 2.23 mg/g), (0.35 – 0.82 mg/g). Alkalinity was found to range from (2 meq/100g – 10 meq/100g) in soil samples.

The content of nickel (Ni), cadmium (Cd), cobalt (Co), zinc (Zn), copper (Cu), chromium (Cr) and lead (Pb) range from: (11.85 - 17.20 mg/kg), (0.95 – 2.28 mg/kg), (6.6 – 9.75 mg/kg), (25.39 – 37.5), (28.1 – 32.25), (79.3 – 165mg/kg), (10 – 13.5 mg/kg). Cr was found more (165 mg/kg) than the typical range (100 mg/kg) in one sample. The genotoxicity in *A. cepa* revealed induction of different types of chromosomal aberrations including laggard, vagrant, stickiness, delayed anaphase, c-mitosis, chromatin bridges and chromosomal breaks. The study clearly show harmful consequences of agricultural soils of Ludhiana which needs immediate attention.

Keywords: Agricultural soil, pollutants, pesticides, heavy metals.

Therapeutic prospective of Broccoli (*Brassica oleracea*) – An overview

Banu Nyori*, Suneeta Singh and Anil Kumar Saxena

School of Agricultural Sciences, SGRR University, Dehradun- 248 001, Uttarakhand, INDIA

ABSTRACT

Broccoli is an edible green plant that is classified in the Italica cultivar group of the species *Brassica oleracea*. They are rich in vitamin C, dietary fiber and also contain glucoraphanin, sulforaphane, selenium and isothiocyanates. Broccoli is also an excellent source of indole-3-carbinol. These constituents present in broccoli are known to be very popular since they possess several anti-cancer properties and benefits. These anti-carcinogenic compounds have a wide variety of uses and benefits for the treatment of various diseases and disorders. Broccoli is widely used in the treatment of several forms of cancer and also treats other neural disorders. The therapeutic potential of broccoli has been explained under its role in cancer, diabetes and other diseases. In the treatment of cancer, most of the constituents or the phytochemicals of broccoli such as brassinin, isothiocyanates, indole-3-carbinol etc. have been proved to be effectively beneficial. Even selenium plays a very important role in cancer prevention. The antioxidant activity of broccoli is induced by other phytochemicals such as glucosinolates, glucoraphanin and sulforaphane. Sulforaphane in broccoli sprouts also has the potential to cure neural disorders such as Alzheimer's disease and Parkinson's disease. It is also used to bring about cure in asthma and diabetic patients. Flavonoids have the effect of reducing the risk of diabetes. Therefore sulforaphane is widely used. Broccoli is an edible green cole crop that is classified in the Italica cultivar group of the species *Brassica oleracea*. It is a nutritional powerhouse, full of vitamins, mineral, dietary fiber and antioxidants. Still raw or cooked broccoli is an excellent source of vitamin C and E. They also contain glucoraphanin, sulforaphane, selenium and isothiocyanates. Broccoli is also an excellent source of indole-3-carbinol. These constituents present in broccoli are known to be very popular since they possess several anti-cancer properties and benefits. It protects against certain types of cancer namely breast cancer, stomach, prostate etc. These anti-carcinogenic compounds have a wide variety of uses and benefits for the treatment of various diseases and disorders. Broccoli is widely used in

3rd International Conference on “Global Initiative in Agricultural, Forestry and Applied Sciences for Food Security, Environmental Safety and Sustainable Development (GIAFAS-2021)”

the treatment of several forms of cancer and also treats other neural disorders. The therapeutic potential of broccoli has been explained under its role in cancer, diabetes and other diseases. In the treatment of cancer, most of the constituents or the phytochemicals of broccoli such as brassinin, isothiocyanates, indole-3-carbinol etc. have been proved to be effectively beneficial. Even selenium plays a very important role in cancer prevention. The antioxidant activity of broccoli is induced by other phytochemicals such as glucosinolates, glucoraphin and sulforaphane. Sulforaphane in broccoli sprouts also has the potential to cure neural disorders such as Alzheimer’s disease and Parkinson’s disease. It is also used to bring about cure in asthma and diabetic patients. Flavonoids have the effect of reducing the risk of diabetes. Therefore sulforaphane is widely used to treat various diseases and disorders. Broccoli leaves were also good sources of calcium and manganese compared to other tissues.

Keywords: Broccoli, vitamins, antioxidants, anti-carcinogenic, isothiocyanates

New records of Tropical Leather-leaf Slug *Laevicaulis alte* (Ferussac, 1822) (Mollusca : Gastropoda : Systellommatophora : Veronicellidae) from Dehra Dun (Uttarakhand, India) and Jamshedpur (Jharkhand, India)

Akhlaq Husain (former Scientist-E, Zoological Survey of India)¹ and Hishmi Jamil Husain²

¹41, Hari Vihar, Vijay Park, Chakrata Road, Dehra Dun – 248001, (Uttarakhand), India

²Centre of Excellence for Biodiversity Management, Corporate Sustainability, Tata Steel Ltd., Jamshedpur-831001 (Jharkhand), India.

ABSTRACT

Laevicaulis alte, the Tropical Leather-leaf Slug is an invasive African slug, got introduced into India. Recently one each a specimen was sighted at Dehra Dun (Uttarakhand, India) and Jamshedpur (Jharkhand, India) which are new records from these areas. In present communication its systematic account, distribution, control measures and other aspects have been dealt.

Keywords: New records, *Laevicaulis alte*, Dehra Dun, Jamshedpur (India).

Digital Agriculture

Sharad Pandey, Gideon Synrem, Mohammad Faisal, Mamta and Vivek Singh

School of Agriculture, Forestry & Fisheries, Himgi Zee University, Dehradun (UK) India

ABSTRACT

Agriculture nowadays has become a big enterprise. With the advent of new technologies, it is not only possible to make quick and precise decisions but also the net return of profit of farming community has also increased. Precision agriculture has now made possible to decide the level of input and time required for reaping maximum benefit per unit area of field. Modernisation of agriculture with the help of advanced technologies is the only answer to get wide variety of agriculture commodities at any time of the year. Blending Agriculture with the use of IT technologies is rapidly changing the life of farmers. Digitalisation of Agriculture has narrowed the gap of farmers, agriculture scientists and consumers. The flow of scientific and weather based information is now accessible to the farmers at their doorstep and on mobiles. The use of drones in agriculture has paved way to identify new diseases and insect pests and has made many agricultural operations in the field very easy. Farmers are well aware of the market and consumers have access to fresh produce from farmers. E-agriculture is helpful in streamlining supply chains and reducing operational costs. Digital Agriculture is bringing the youth back to agriculture domain. Smart Technologies are helping the farmers to invest judiciously. Access to international markets is made easy with the help of digital technologies. Government interventions with the help of different digital portals for agriculture like NeGPA, mKisan, eNAM is now having an impact on the income of farmers.

Keywords: Agriculture, Enterprise, Digital Agriculture, Market

Response of Liquid Biofertilizer, Plant Geometry and Different Levels of Phosphorus on Growth and Yield of Green Gram (*Vigna radiata* L.)

Schchida Nand Singh, Vikram Singh, Moinuddin, Manoj Shukla³ and Sharad Pandey⁴

Himgiri Zee University Dehradun, (U.K.) India

SHUATS- Naini, Prayagraj (Uttar Pradesh) India.

Shri Guru Ram Rai University- Dehradun, (U.K.) India

MCAT - Dehradun, (U.K.) India & Himgiri Zee University- (U.K.)

ABSTRACT

A field experiment was conducted during *zaid* season of 2016 and 2017 at crop research farm in Department of Agronomy SHUATS, Prayagraj. To study the response of liquid biofertilizer, plant geometry and different levels of phosphorus on growth and yield of green gram (*Vigna radiata* L.). Total 24 treatment combination comprising of 4 levels of bio-fertilizer viz B1 -Untreated, B2 – Rhizobium, B3 – Phosphate solubilizing bacteria and B4 – (Rhizobium + Phosphate solubilizing bacteria), two levels of spacing viz S₁–30 cm × 15 cm and S₂– 45 cm × 15 cm, three levels of phosphorous viz, P₁ – 40 kg P₂O₅ / ha, 60 kg P₂O₅ / ha and 80 kg P₂O₅ / ha. The experiment was laid out in RBD (factorial) with three replications. The basic information on physico-chemical properties of soil indicated that the soil of the experimental field was sandy loam which was low in organic carbon, nitrogen and phosphorous and medium in potassium. The treatment combination of *Rhizobium* + Phosphate solubilizing bacteria, 30 cm × 15 cm and 60 kg P₂O₅ / ha recorded plant height (72.53 cm), maximum plant dry matter accumulation (15.93 g), number of branches per plant (8.77), number of nodules per plant (15.30), maximum leaf area (160.36 cm²), leaf area index (0.35) and chlorophyll content (41.67) in pre harvest observation. It was also observed that in post harvest observation, number of pods / plant (38.59), pod length / pod (10.48 cm), number of grains / pod (10.48), grain yield (15.12 q /ha) and stover yield (27.24 q / ha) was recorded maximum in the treatment combination of *Rhizobium* + Phosphate solubilizing bacteria, 30 cm × 15 cm and 60 kg P₂O₅ / ha. However, the test weight (33.84 g), harvest index (40.22) and protein content (22.32 %) were found to be non significant. On the basis of economics of different treatment combination the maximum B:C (1.66) ratio was recorded under treatment *Rhizobium* + Phosphate solubilizing bacteria, 30 cm × 15 cm and 60 kg P₂O₅ / ha.

Keywords: *Rhizobium*, PSB, spacing, Phosphorous and green gram

Nutraceutical analysis in faba bean (*Vicia faba*) on variability and yield

S. K. Yadav*, H.L.Raiger, Ravi Kumar¹ and N.K. Jajoriya

ICAR-National Bureau of Plant Genetic Resources, Pusa Campus, New Delhi – 110012

¹*Department of Plant Breeding, CCS HAU Hisar - 125004*

ABSTRACT

Faba bean (*Vicia faba*) also known as broad bean is mainly grown in hills and northern plains for its protein rich pulse and green pods which are used as vegetable. It is an annual crop used both for human consumption and as well as live stock feed. Faba bean is grown in over 3 million hectares in the world with a total production is over 4.5 million tons. Efforts have been made to evaluate, characterize, conserve and catalogue the genetic resources of faba bean. Improvement for the seed and protein yields are receiving foremost attention in this crop. Hence there is a need to intensify efforts to search for appropriate donors for utilization in the specific breeding programmes. The crop should be beneficial for the farmers, producers and to the users. There is a need for development of high yielding nutritionally rich and should be free of anti nutritional factors such as tannin and phytate genotypes. In the present paper an attempt has been made to evaluate the genetic resources of a faba bean augmented recently to assess their potential use in varietal development programme for faba bean. Thirty five faba bean genotypes were assessed for nine agronomic and quality traits against three elite varieties HFB-2, HFB-1 and Vikrant in Augmented Block Design during Rabi 2018-19 and 2019-20 under the multilocation programme of AICRN on potential crops. There was significant difference among the blocks for pod length and 100 seed weight but no difference was observed for days to flowering, days to maturity, plant height, number of pods per plant, number of seed per pod and yield per plant. Among germplasm line, ET218772 (33.81 g), ET218776 (30.78 g), ET218725 (28.69 g), ET218786 (28.29 g) showed highest seed yield per plant as compared to check variety Vikrant (27.62 g). The genotypes ET218768 (27.07%) had a higher protein content than the best check Vikrant (26.89%). The least antinutritional factor Vicine-convicine was found in ET218768 (0.52%).

Keywords: Quality, faba bean, Genetic Resources, Vicine-convicine

RESPONSE OF NUTRIENTS ON POTATO YIELD

AMRENDRA KUMAR

DEPARTMENT OF AGRONOMY, TCA, DHOLI, BIHAR

ABSTRACT

Experiment was conducted in Tirhut college of Agriculture, Dholi farm in 2020 with six different treatments, 50% RDF OF NPK, 100% RDF OF NPK, 150% RDF OF NPK, Without N Fertilizer (PK), without P (NK), without K (NP) without NPK (Absolute control) with variety KUFRI ARUN, design RBD, replication-4 spacing 60x20 cm plot size-4.8x4.0 m² and plot size 3.6x3.6 m² soil was sandy loam. Maximum plant emergence percentage (98.25%), plant height (46.48), no. of shoot/plant (5.58cm), yield (23.76 t/ha) was found under treatment T₃ i.e 150% RDF OF NPK. Maximum Net return (144990 rs) and Benefit cost ratio (1.57) was also noticed under 150% RDF OF NPK. Treatment T₂ and treatment T₆ was found closed to treatment T₃ in respect yield as well as net return and benefit cost ratio.

Keywords: Different Fertilizers Dose, Growth and Yield.

Isolation, characterization and management of bacterial wilt of potato caused by *R. solanacearum* through resistance inducer chemicals.

R. K. Ranjan, P. K. Jha and Bimla Rai

Department of Plant Pathology, Dr. Rajendra Prasad Central Agricultural University, Pusa, Samastipur (Bihar) – 848125.

ABSTRACT

Bacterial wilt of potato caused by *Ralstonia solanacearum* Yabuuchi *et al.* (1995) is one of the most important bacterial diseases of potato crops. Now, the disease is known to occur in all the states of India. The high percentage of plant mortality and lack of effective control methods make *R. solanacearum* one of the world's most destructive plant pathogens. Therefore, isolation, characterization and management bacterial wilt of potato by using resistance inducer chemicals were studied in the present investigation to prevent the further spread of the disease. The colonies of *Ralstonia solanacearum* isolated from wilted potato plant on TTC medium, colonies selected on the basis fluidal, irregular and creamy white with pink at the centre. Twelve strains of *R. solanacearum* isolated from potato were characterized into biovar on the basis of their ability to utilize disaccharides and to oxidize hexose alcohols. Out of 6 biovars present in the world, two biovars, i.e., bv2 and bv2T were found in Bihar to infect potato plants. Out of the 12 strains, 75 % belonged to bv2 and 25 % bv2T. One month old potato (Kufri Red) seedlings were drenched with 50 ml, 3mM concentration of resistance inducers chemicals like Acibenzalor – s- methyl (ASM), Beta aminobutyric acid (BABA), Benzoic acid (BA) and Salicylic acid (SA). Control pots were drenched with sterilized water. After 2 days of drenching with resistance inducer chemicals half of potato plants were inoculated with *R. solanacearum*. The observations were recorded after 7, 14 & 21 days after inoculation. The results revealed that the minimum population of *R. solanacearum* was found (2.752 cfu log/g tissue) in Acibenzalor s methyl treatment followed by Benzoic acid (3.164 cfu log/g), Salicylic acid (3.318 cfu log/g) and Beta aminobutyric acid (3.762 cfu log/g tissue) after 21 days of inoculation. The maximum population of *R. solanacearum* was found (4.591 cfu log/g tissue) in control.

An Economic Analysis of Soybean cultivation in Ujjain district of Madhya Pradesh, India Shiva Pujan Singh*, Md. Minnatullah, Satyam Lema, C. S. Chaudhary.

Dr. Rajendra Prasad Central Agricultural University, Pusa, Samastipur.

ABSTRACT

The focus of the present study was on economic evaluation of soybean cultivation has been conducted in Ujjain district of Madhya Pradesh for the period 2019-20 by collecting data on various aspects of costs and returns, benefit cost ratio (BCR), in the study area. A sample size of 60 farmers was selected using random sampling method (SRS) and data were elicited through survey method. The study has shown that on an average cost of cultivation of soybean were estimated to be Rs. 31871.16 per hectare out of which share of variable and fixed costs was 55.39 percent and 34.82 percent respectively. In the district of Ujjain, the average overall price of soybean per quintal was Rs. 3945.00, whereas, overall yield per quintal was 15.89 Quintals. The study also revealed that over income of the farm was Rs. 31871.16 per hectare. It was also observed that the net returns tended to decrease with increase in farm size. The average net return

3rd International Conference on “Global Initiative in Agricultural, Forestry and Applied Sciences for Food Security, Environmental Safety and Sustainable Development (GIAFAS-2021)”

per hectare was amounted to be Rs. 30027.29 in the study area. The study has shown that the value of BCR (benefit cost ratio) was highest for small farms (1.36) and lowest on large farm (1.24) in this region. It was observed that soybean production is more profitable and labour intensive, therefore it fit well in the small farms, was more used of family labour in comparison with large size farm. Hence small holders are relatively more efficient in production in contrast to large farmers.

Keywords: soybean, costs and returns, Madhya Pradesh, India.

INNOVATIVE APPROACHES IN AGRICULTURE

Tanweer Alam, Shivakumara M N Vinay kumar Choudhary and Ram Kumar Choudhary

Dr. Rajendra Prasad Central Agricultural University, Pusa, Samastipur, Bihar-848125

ABSTRACT

Innovative approach in agriculture and allied sciences comprises technology, practice or product handling that will bring increased yield and income to the farmer, modern/ improved or superior production technique used to improve production or quality and quantity required at a given time, opportunities for development of the concept like community-supported agriculture and opportunities for development of organic farming in respect to sustainable growth achievement etc. It is provoked by the progressive development of organic production, water management, weather prediction, processing of food, plant protection etc. The innovative approach in agriculture includes sustainable management of natural resources, high standards for food quality and safety, human attitude towards animals; economic effectiveness, employment and rural development. The recent innovative approach in agriculture was hydroponics, aeroponics, and aquaponics. The important areas where innovation provides opportunity for advancing agriculture were concerning agricultural sector were in fostering thematic innovations, enhanced cooperation, advisory service systems, financing innovation processes, production technology and practices, innovative technologies for livestock (housing, feeding, breeds, milking), horticulture, advanced technologies in vegetable cultivation, greenhouse technology, dairy production, beekeeping, new varieties and breeds for specific crops and livestock types, new production technologies for specific crops and livestock types, seedling production for vegetables, sustainable irrigation practices (e.g. preventing erosion), environmentally sound production practices, minimal and zero tillage, family farming, economic, market and quality issues, agricultural value chain and market systems development, farm economic analysis, monitoring and planning, establishment of joint enterprises, establishing gap standards and systems, new approaches to farm management, certification system for organic production, food safety and quality management system, infrastructure, equipment and machinery, mini-processing facilities (dairy, fruits, vegetables), agricultural machinery for small farms, drip irrigation, market mechanisms for their introduction, mechanization, development of innovative infrastructure, storage technologies (e.g. for fruits), expanding organic farming, science-based resource-conserving and ecologically clean production, cultivation of rainfed lands, green economy and resource.

Elephant foot yam [*Amorphophallus paeoniifolius*] diversification in vegetable crops

A. Narayan*, R.S. Singh, R. Prasad and G.S. Giri

Department of Plant Breeding and Genetics, TCA, Dholi, Dr. RPCAU, Pusa, Bihar, India.

ABSTRACT

Tuber crops play an important role in food and nutritional security apart from generating income, employment and livelihood opportunities. Elephant Foot Yam (EFY) commonly known as “Jimikand or Oal” is an important tuber crop and was considered as subsidiary vegetable crop till a decade back in Bihar. Before 1990’s the farmers of Bihar never imagine for commercial cultivation of elephant yam. Introduction of Gajendra variety from Andhra Pradesh under All India Coordinated Research Project on Tuber Crops and its subsequent release for commercial cultivation in Bihar in 1991 was considered a land mark in improvement of EFY cultivation in Bihar. This variety is non-acrid having high yield potential (45 to 50 t/ha) and excellent cooking quality. The farmers of North Bihar in general and its five districts viz., Muzaffarpur, Samastipur, Vaishali, Begusarai and East Champaran in particulars having well drained upland soils have taken up the cultivation on commercial scale. It is considered as *Money spinning crop* because it provides a great potential to growers for earning a net profit of Rs. 3.50 - 4.0 lakh/ha. The area under its cultivation increased about 5 folds in Bihar during last 15 years. Presently, this crop is being grown in approximately 1500 hectare area of North Bihar. Considering its importance, an experiment was conducted using 21 germplasm of Elephant foot yam including Gajendra as national check to find out genetic divergence among the studied germplasm. The experiment was carried out at T.C.A., Dholi Research Farm of Dr. R.P.C.A.U., Pusa, Samastipur, Bihar, in a completely Randomized Block Design with two replications during 2018. Data were collected for ten characters viz., days to sprouting, pseudostem length (cm), pseudostem girth (cm), leaf canopy diameter (cm), chlorophyll content (SPAD value), calcium oxalate

3rd International Conference on “Global Initiative in Agricultural, Forestry and Applied Sciences for Food Security, Environmental Safety and Sustainable Development (GIAFAS-2021)”

(mg/100gm), dry matter (%), days to maturity, no. of cormels per plant and corm weight per plant (kg.). Analysis of variance revealed highly significant differences among the germplasm for all the ten characters under study. All the twenty one germplasm were grouped into five clusters using Mahalanobis D² statistics following clustering suggested by Tocher. Highest inter cluster distance was observed between cluster IV and V (238.93) followed by cluster I and IV (229.41) and cluster III and V (172.38) on the basis of their genetic distances. Cluster IV showed maximum cluster mean values for corm weight per plant and for other attributing characters like pseudostem girth, leaf canopy diameter, chlorophyll content, calcium oxalate, dry matter and days to maturity. Calcium oxalate followed by corm weight per plant, days taken for sprouting and number of cormels per plant were having maximum contribution towards total genetic divergence.

Keywords: Elephant foot yam, genetic diversity, cluster analysis.

Biomimetic textiles: An innovative approach towards conserving the future

Pratikhya Badanayak^{1*} and Jyoti V. Vastrad¹

Department of Textile and Apparel Designing, College of Community Science, University of Agricultural Sciences, Dharwad, Karnataka, India- 580005.

ABSTRACT

Nature has developed over billions of years to generate more efficient solutions than comparable man-made solutions in the field of textile, such as superhydrophobicity, self-cleaning, self-repair, energy conservation, drag reduction, dry adhesion, adaptive growth, and so on. There are many examples of functional surfaces, fiber structures, structural colours, self-healing, thermal insulation, and other features that can be applied to future textile products. Biomimetic research is a rapidly expanding field, and the ultimate potential of the issue in the production of novel and sustainable textiles can only be achieved through multidisciplinary study based on a holistic understanding of nature. In this paper, an insight looks at the potential bio-inspired textile structure was addressed to the greatest extent possible. Furthermore, the future usefulness of various biomimetic textiles was discussed. Essentially, this discipline can serve as a source of inspiration for ongoing material progress. Biomimicry has the ability to improve manmade materials and pave the way for the next generation of technical, high-performance materials, ranging from novel materials and properties to innovative structures and designs, as well as product and process sustainability.

Keywords: Biomimicry; innovative textiles; natural approach; biomimetic textiles; next generation technology

Effect of Fertigation on Carnation cultivation under Polyhouse

S.K.Nirala, R.Suresh and Sunil Kumar

Precision Farming Development Centre, Department of Soil and Water Engineering, College of Agriculture Engineering, R.P.C.A.U.,Pusa (Samastipur) Bihar -848125

ABSTRACT

A study on “Fertigation Effect in Carnation under Polyhouse” was carried out under twelve (12) treatments, i.e., 3 main treatments on variety, namely; V₁: Loris; V₂: Pingu & V₃: Gioele, and 4 sub- treatments on fertigation, i. e, F₁: 80 % fertigation of RDF of NPK; F₂: 100% fertigation of NPK; F₃: 120% fertigation of NPK and F₄: 100% application of RDF (control) adopting split plot design. The average daily month wise water requirement per plant of Carnation was computed minimum 0.12cm in January and maximum 0.56 cm April. The total water requirement during crop period was found to be 66.56 cm. Among different varietal treatments, the treatment V₂(Pingu) recorded maximum number of branches (9.80); minimum days for bud initiation (89.83 days)& flowering(164.83 days) ; maximum flower diameter (7.83cm) and stalk length (60.22cm) & girth (4.43 mm) as well as maximum number of flowers per m² area 353.The fertigation treatment F₃ (120% fertigation of RDF of NPK) was found very effective, might be due to application of higher doses, resulted maximum plant heights 87.18cm at 210 DAT. Also, the number of branches (11.59); minimum time for bud formation (87.89 days), minimum days to flowering (165.11 days), maximum stalk length (57.83cm) and girth (4.91mm) as well as maximum number of flower per m² area (353.22). The b/c ratio was also found highest in treatment F₃, i.e. 2.60, 2.56 and 2.59 whereas lowest 0.81, 0.96 and 0.85 found in control treatment (F₄) for Loris, Pingu and Gioele respectively.

Keywords: Polyhouse, Carnation, Water requirement, Fertigation, B/C ratio

Growth and Instability in Area, Production and Productivity of Coffee in Kodagu district and Karnataka state

Thanuja P^{1*}, G.L. Meena², Babita Kumari³

Department of Agricultural Economics and Management, MPUAT, Udaipur, 313001, India

Department of Agricultural Economics, SKRAU, Bikaner, Rajasthan

ABSTRACT

Coffee is known as sage's milk and brown gold conquered third position among most transacted good in international market. India is the one of the most leading producer of coffee. Karnataka stands first in Area and production of coffee with having Kodagu District as the “coffee cup of India”. The present study completely depended on secondary data collected from 2000-01 to 2019-20 and aimed to estimate compound growth rate in area and production of coffee in kodagu district as well as Karnataka state. Compound growth rate and Cuddy-della valle instability index was used for the study. The study revealed that the growth rate over years for both area and production under Kodagu district and Karnataka state was very less showing very less increase in both parameters. It may be due to the long life span of coffee plant. Instability in production and area of the state as a whole was highest compared to instability in area and production of Kodagu district.

BROWN MANURING BASED WEED MANAGEMENT PRACTICES IN DIRECT SEEDED RICE (*ORYZA SATIVA* L.)

Sandeep S N¹, S. Pazhanisamy¹, Vidyashree B S², S K Chaudhary¹ and Dharminder¹

Department of Agronomy, Dr. Rajendra Prasad Central Agricultural University, Pusa (Samastipur), Bihar. Department of Agronomy, University of Agricultural Sciences, Dharwad.

ABSTRACT

A field experiment entitled “Brown manuring based weed management practices in direct seeded rice (*Oryza sativa* L.)” was conducted at Dr. Rajendra Prasad Central Agricultural University, Pusa (Samastipur), Bihar during *kharif* season, 2020. The trial was carried out in randomized block design with replicated thrice. The treatment comprised of ten different weed management practices *viz.*, T₁- Pendimethalin (1 kg a.i ha⁻¹) PE *fb* bispyribac sodium (30 g a.i ha⁻¹) at 15 DAS (POE), T₂- Pendimethalin (1 kg a.i ha⁻¹) PE *fb* pyrazosulfuron (30 g a.i ha⁻¹) at 15 DAS (POE), T₃-Pendimethalin (1 kg a.i ha⁻¹) PE *fb* Bispyribac sodium + pyrazosulfuron (25g a.i ha⁻¹ each) (POE as Tank mix), T₄- Bispyribac sodium + pyrazosulfuron (25g a.i ha⁻¹ each) (POE as Tank mix), T₅- Pendimethalin (1 kg a.i ha⁻¹) PE + brown manuring at 20 DAS with 2, 4 - D ester (0.70 kg a.i ha⁻¹) (POE), T₆- Pendimethalin (1 kg a.i ha⁻¹) PE + brown manuring at 20DAS with 2, 4 - D ester (0.70 kg a.i ha⁻¹) *fb* pyrazosulfuron (25 g a.i ha⁻¹) 25 DAS, T₇- Pretilachlor (0.75 kg a.i ha⁻¹) PE + brown manuring at 20DAS with 2, 4 - D ester (0.70 kg a.i ha⁻¹) *fb* bispyribac sodium (25 g a.i ha⁻¹) 25 DAS, T₈- Pretilachlor (0.75 kg a.i ha⁻¹) “PE + brown manuring at 20 DAS with 2, 4 - D ester (0.70 kg a.i ha⁻¹) *fb* pyrazosulfuron (25 g a.i ha⁻¹) 25 DAS, T₉-Weed free and T₁₀-Weedy check. The rice variety “Abhishek” was chosen as the test crop. This experiment was carried out by using of RDF-120-60-40 kg/ha of N, P₂O₅ and K₂O, respectively and other practices as per the standard package of practices for rice production was followed. Among the weed management practices, Weed free (T₉) obtained maximum growth parameters (tillers/m², dry matter production and crop growth rate), Grain yield (4.65 t ha⁻¹), straw yield (5.25 t ha⁻¹) and yield attributes *viz.* panicles/m² (305), grains/panicle (108) while remaining at par with Pretilachlor (0.75 kg a.i ha⁻¹) PE + brown manuring at 20 DAS with 2, 4 - D ester (0.70 kg a.i ha⁻¹) *fb* bispyribac sodium (25 g a.i ha⁻¹) 25 DAS (T₇) and Pretilachlor (0.75 kg a.i ha⁻¹) PE + brown manuring at 20 DAS with 2, 4 - D ester (0.70 kg a.i ha⁻¹) *fb* pyrazosulfuron (25 g a.i ha⁻¹) 25 DAS (T₈). Higher benefit cost ratio was recorded in T₈ (1.41). It may be due to broad-spectrum weed control with both pre and post emergence herbicides along with brown manuring with *Sesbania* resulted in maximum growth and yield attributes and weed suppression.

Keywords: Brown manuring, Direct seeded rice, Herbicides.

Study of induced resistance in Brinjal (*Solanum melongena*) against Phomopsis blight (*Phomopsis vexans*): A Review

MD. SHUJA AHMAED*, ADESH KUMAR, ADARSH SHARMA, AND TAMMANA RANA

Department of Plant Pathology, School of Agriculture, Lovely Professional University, Phagwara – 144 411, Punjab, India

ABSTRACT

Phomopsis blight caused by *Phomopsis vexans* has been a devastating disease that affects the production of brinjal by 40–70% and makes brinjal fruits unmarketable and inedible, limiting their role in income generation, nutrition, and health. Cultural, mechanical, biological, and chemical methods have been discussed and used extensively in previous researches. Though the chemical methods for the management were found most effective and accepted worldwide by the grower, it has many negative consequences to humans, environment, soil, water, and plant bodies. Heavy use of fungicides also results in developing resistance to plant pathogens. So, there is a strong need of one environmentally friendly and healthy approach which allows a plant to develop resistance. This concept of developing resistance into the plant system is termed as induced resistance, one of the induced resistances is systemic acquired resistance works on the principle of the salicylic acid pathway while induced systemic resistance works on the principle of the jasmonic acid pathway. This manuscript gives a review, why *Phomopsis* blight is an economically important disease of brinjal and gives an extensive discussion on sustainable management strategies in comparison to the conventionally recommended control for the disease.

Keywords: Brinjal; *Phomopsis* blight; *Phomopsis vexans*; Induced resistance; Salicylic acid Pathway; Jasmonic acid Pathway.

DEVELOPMENT AND STANDARDIZATION OF PREBIOTIC NUTRIBAR

S. Sucharitha, M. Akshay, I. Ramu and Prashanthi Meda*

College of Food Science & Technology, Rudrur

Professor Jayashankar Telangana State Agricultural University (PJTSAU)

ABSTRACT

Nutribars are the most popular and widely consumed products in India. Compared to Bars, the present investigation was undertaken on the basis of prebiotic property of ingredients for the preparation of nutribars. There are very less number of prebiotic products that are available in India. The existing thing is to develop the prebiotic based nutribars by standardization of ingredients by stimulating the growth of one or more desirable or health-enhancing gut bacteria.

Isolating the Probiotic bacteria i.e., *Lactobacillus casei shirota* strain from Yakult milk. The isolated bacteria with the prebiotic ingredients such as oats, ragi, flax seeds and almonds were incubated at 37°C for two days and conformed that the solubilisation of ingredients with *Lactobacillus* and quantified with different proportions along with the addition of jaggery, olive oil and coconut powder. On the basis of overall acceptability in sensory evaluation, Prebiotic bars was standardized with flax seeds (20 g), ragi (10 g), oats (10 g), jaggery (30 g), olive oil (10 g), almonds (10 g) and coconut Powder (10 g).

The proximate composition of the standardized sample showed a moisture content of (8.0±0.5%), ash content of (5.2±0.9%), fat content of (14±0.2%), protein content of (18.5±1.25%), carbohydrate content of (48.86±3.25%), calcium content of (26 mg/100 g), and iron content of (16 mg/100 g). Prebiotic nutribar packaging done aseptically in polythene covers. This study indicates the prospects for the development of prebiotic nutri bars with enhanced nutritional quality and sensory attributes.

It is concluded that, developed the product having the overall acceptability, provided the adequate amounts of carbohydrates, protein and fat. It is also a good source of Iron and calcium. Increasing the demand for consumption of prebiotic products as nutri bars towards youngsters.

Keywords: Nutri Bar, *Lactobacillus casei*, proximates, prebiotics, probiotics.

DEVELOPMENT AND STANDARDIZATION OF QUINOA BASED NUTRIA-BAR

G Pravalika, G Srinidhi, G Vineeth kumar and Sushma Devi Rodda*

College of Food Science & Technology, Rudrur

Professor Jayashankar Telangana State Agricultural University (PJTSAU)

ABSTRACT

This study was carried out at CFST, Rudrur, Telangana during 2021. The main objective of this study was to develop a nutritive, low cost and stable quinoa based nutri-bars for obese people. Nutri-bars were developed and standardized in four different formulations. The study is to develop a nutri-bar using Quinoa with Flax seed, chia seeds, nuts and dried fruits. Four bar prototypes were designed and evaluated in a consumer acceptance test where the attributes flavor, sweetness, texture, and appearance were assessed. The prototype (F₄) with composition of 25% Quinoa; 6% Flax seeds;

3rd International Conference on “Global Initiative in Agricultural, Forestry and Applied Sciences for Food Security, Environmental Safety and Sustainable Development (GIAFAS-2021)”

6% Chia seeds; 14% Almonds; 13% Jaggery; 11% dried cranberry; 1% Salt; 3% Ghee; 18% honey; 1% agar-agar attained the highest acceptance scores. F₄ sample contained 17.88% protein, 13.5% fat, 18.35% Fibre, 5.05% Moisture, 1.99% Ash, 30.99mg Calcium compared to other prototypes. Sensory parameters were observed for a period of 60 days in time interval of 15 days at ambient temperature. Hardness of the bar decreased significantly during storage. The results showed that Proximate composition and consumer acceptance was best for F₄ sample.

Keywords: Quinoa, nutri-bar, Sensory evaluation, proximate analysis

Microbial Enrichment of Organic Manures on Survivability of *Rhizobium* and Phosphate Solubilizing Bacteria in Organic Manures

Sushma Devi Rodda and Subhash Reddy R

Department of Agricultural Microbiology and Bioenergy, College of Agriculture, Rajendranagar, Hyderabad-500030.

ABSTRACT

The present study was revealed the survivability of *Rhizobium* and Phosphate Solubilizing Bacteria in Organic Manures enriched with *Rhizobium* and Phosphate Solubilizing Bacteria (PSB) separately in plastic trays. This study conducted at Department of Agricultural Microbiology and Bioenergy, College of Agriculture, Rajendranagar, Hyderabad, Telangana for checking the compatibility of potential strains with the natural medium application to the crops. Six types of organic manures were used for this experiment viz., Farm yard manure, pressmud, vermicompost, neem cake, castor cake and pongamia cake. The population of *Rhizobium* and PSB were significantly increased in all the six organic manures until the end of the 3rd week of storage period and gradually decreased up to 6th week of storage period. The survivability of *Rhizobium* and PSB was best in vermicompost compared to other organic manures. But all the organic manures enriched with biofertilizers maintains 10⁸ CFU g⁻¹ microbial population up to one month. It is to be suggest that the combination with both *Rhizobium*, PSB with vermicompost was good in terms of their viability as well as for supply of nutrients to the crops covers the major sources Nitrogen, Phosphorous from the nature.

Pathogenicity of root-knot nematode, *Meloidogyne incognita* and root-rot fungus, *Sclerotinia sclerotiorum* alone/ and in combination on the disease development and plant growth of *Mentha arvensis* Syed Abuzar Coromandel International Limited, Secunderabad, India. The Studies were conducted to determine the effect root-knot nematode, *Meloidogyne incognita* and root-rot fungus, *Sclerotinia sclerotiorum* alone and in combinations on the growth of *Mentha arvensis*. Experiment was conducted under green house conditions [(25±3) °C and (58±6) % RH] and terminated seventy-five days after inoculation. Results indicated that the inversely proportional relationship between initial inoculum densities (Pi) of *M. incognita* / *Sclerotinia sclerotiorum* and plant length, fresh and dry weights. Reduction in all growth parameters was observed significantly (P≤0.05) at minimum Pi (500 J₂/pot of *M. incognita* and/or 0.5 ml of *Sclerotinia sclerotiorum* spore suspension with 10⁸cfu/ml) of both the pathogens. Relationship between final nematode population / root-knot index and Pi was observed directly proportional. Simultaneous inoculation of both the pathogens increases the severity of disease followed by nematode and fungus alone.

Keywords: *Mentha arvensis*, Nematodes, Fungus, Interaction, Pathogenicity

Effect of root-knot nematode, *Meloidogyne incognita*-wilt fungus, *Fusarium oxysporum* disease complex of Field Pea, *Pisum sativum*, and its management through integrated approach under field conditions

Syed Abuzar

Coromandel International Limited, Secunderabad, India

ABSTRACT

A field experiment study was conducted to determine the comparative efficacy of carbofuran at 1 mg a.i. /kg soil, bavistin at 1 mg a.i./kg soil, neem (*Azadirachta indica*) seed powder at 50 mg/kg soil, green mould (*Trichoderma harzianum*) at 50.0 ml/kg soil, rhizobacteria (*Pseudomonas fluorescens*) at 50.0 ml/kg soil against root-knot nematode, *Meloidogyne incognita*–wilt fungus, *Fusarium oxysporum* disease complex on Field Pea, *Pisum sativum*. All the treatments significantly improved the growth of the plants as compared to untreated inoculated plants. Analysis of data showed that carbofuran and *A. indica* seed powder increased plant growth and yield significantly more in comparison to Bavistin and *P. fluorescens*. Carbofuran was highly effective against nematode, Bavistin against fungus, *A. indica* seed powder against both the pathogens and both the bioagents were moderately effective against both the pathogens.

Keywords: *Meloidogyne incognita*, *Fusarium oxysporum*, Disease complex, Integrated management, Field Pea

Brown Midrib Sorghum (*Sorghum Bicolor* (L.) Moench): Potential Source for Fodder Quality Improvement

A.W. More^{1*}, D.B. Deosarkar², S.P. Mehtre³ and H.V. Kalpande¹

Department of Agril. Botany, Vasantryao Naik Marathwada Krishi Vidyapeeth, Parbhani-431 402. (MS), India

ABSTRACT

The value of a crop plant as forage is primarily determined by the digestibility and biomass production per unit area. Brown midrib sorghum is bringing attention for utilization of sorghum as high quality forage crop due to its low lignin content. Therefore present study was carried out to identify the response of the brown midrib sorghum genotypes in manipulating the fodder quality improvement and better combining parents. 30 F₁s along with 12 parents and two checks viz., CSH 15 R and CSV 22 R were evaluated at Sorghum Research Station, VNMKV, Parbhani during *rabi* 2018-19 in Randomized Block Design with three replications. Observations were recorded on randomly selected 5 five plants in each replication for grain yield, fodder yield and fodder quality parameters. Parbhani Moti and CSV 29R among the lines and Bmr 7-4-1 and Bmr 7-2-2 among tester exhibited higher mean values and desired *gca* effects for grain yield and its contributing traits plant height, panicle breadth, number of primary branches, 100 grain weight and harvest index. These lines also manifested higher mean and desired *gca* effects for fodder yield and its contributing traits viz., plant height, number of leaves, leaf area, L:S ratio, stem girth and biological yield per plant. For crude fibre, digestibility and acid detergent lignin Bmr testers performed significantly better than white midrib lines both for *per se* performance and *gca* effects. Highest *per se* performance along with significantly higher *gca* effect for IVOMD percentage was expressed by Bmr 7-4-1 and Bmr 7-2-2, while among lines MS 104 B, PMS 71 B and Parbhani Moti exhibited desirable positive *gca* effects and mean performance. Moreover the parents showing higher IVOMD also exhibited higher *per se* performance and positive GCA effects for metabolisable energy (ME) and lower percentage of acid detergent lignin (ADL), acid detergent fibre (ADF) and neutral detergent fibre (NDF) and cellulose content along with desirable negative *gca* effects indicating the potentiality of these parents for breeding nutritious and more digestible fodder varieties or hybrids. Therefore there is good scope to use the lines; Parbhani Moti, CSV 29 R and PMS 71 B and testers Bmr 7-4-1 and Bmr 7-2-2 as a potential source of genes in future breeding programme to improve the fodder quality along with higher grain and fodder yield potential. It is worthwhile to use these parents to exploit additive gene effects by isolating desirable Bmr recombinants with low ADL and higher IVOMD content along with higher yield in segregating generations.

Keywords: *brown midrib sorghum, general combining ability, fodder quality parameters.*

Variability studies in *Rabi* Sorghum (*Sorghum Bicolor* (L.) Moench) Germplasm Line for Drought Adaption

More Ambika Kalpande¹ H.V.¹ and D.B. Deosarkar

Department of Agril. Botany, Vasantryao Naik Marathwada Krishi Vidyapeeth, Parbhani-431 402.(MS), India,

ABSTRACT:

With its C₄ photosynthetic pathway, it is adapted to a wide range of environmental conditions and has multiple use as a food, fodder, fuel and fibre. However the productivity of *rabi* sorghum in Maharashtra is very low. There is a need to characterize and identify high yield potential genotypes along with drought tolerance ability. Therefore present study was undertaken to characterize and analyze the variability of *rabi* sorghum genotypes for morpo-physiological traits. 28 *rabi* adapted sorghum germplasm lines were evaluated along with the with 2 checks (B-35 and CSV-23) in randomized block design. Experiment was conducted in three replications at experimental farm of Sorghum Research Station, Vasantryao Naik Marathwada Krishi Vidyapeeth, Parbhani. Observations were recorded on randomly selected five plants in each entry from each replication for 14 characters and subjected to analysis of variance. Phenotypic and genotypic coefficients of variation were calculated according to Burton (1952). Results revealed the wide range of variability for majority of yield contributing characters under study. The genotype IS-21083 recorded earliest 50 percent flowering followed by SPV-462, IS-23521, CSV-15 and IS-23684. CSV 15 exhibited significantly highest grain yield per plant (80.44 g/plant) followed by CSV 20 (62.05) and CSV 2455 (57.45 g). The genotypes with higher grain yield also exhibited significantly higher estimates of leaf dry weight, stem dry weight, total biomass, panicle dry weight, grain numbers per panicle, 1000 seed weight and harvest index. Moreover CS 2455, IS 23684, CSV 15, IS 21083 also recorded significantly higher chlorophyll content, relative water content, leaf area, leaf area index and less stomata index which are drought contributing parameters. Therefore the aforesaid genotypes might be the good source of drought tolerance and higher yield potential. Besides B-35 and E 36-1 which are a drought tolerant source with highest stay green score, genotypes SPSSV 30, CSV 20, and IS 23579 scored stay green score at par to these sources.

Genotypic coefficient of variation estimates was lower than phenotypic coefficient of variation for all the characters. high estimates of genotypic and phenotypic coefficient of variation were recorded for the traits leaf dry weight, stem dry weight, panicle dry weight, total biomass, plant height, dry stover yield, harvest index, grain number per panicle, 1000 grain weight, leaf area, leaf area index and grain yield per plant. While genotypic and phenotypic coefficient of variation were moderate for days to 50% flowering, stay green score, chlorophyll content, relative water content and stomatal index. The high values of GCV and PCV for grain yield and Total biomass suggested that there was a possibility of improvement of grain and fodder yield through direct selection.

Key words: Phenotyping, genetic variability, *rabi* sorghum, drought

Comparative Performance of Single-Cut Sorghum for Green Fodder Yield

A.W. More*, K.R. Kamble and L.N. Jawale

Sorghum Research Station, Vasant Rao Naik Marathwada Krishi Vidyapeeth, Parbhani-431402, Maharashtra, India

ABSTRACT

Fourteen test entries comprising 12 varietal and 3 hybrid test entries were evaluated along with one hybrid check i.e. CSH 13 and three varietal checks namely CSV 21F, CSV 30F and local check PVK 809 at Sorghum Research Station, VNМКV, Parbhani during *khari*f season of 2016. For grain yield only one hybrid entry SPH 1797 (479.3 q/ha) recorded significantly highest green fodder yield over hybrid check CSH 13 (460 q/ha). While SPH 1822 (461.7 q/ha) recorded statistically highest green fodder yield over the hybrid check. Among varietal entries none of the entry recorded significantly higher green fodder yield over CSV 30F. However, total five varietal entries viz. SPV 2387 (497.8 q/ha), SPV 2375 (493.3 q/ha), SPV 2389 (489.7 q/ha), SPV 2388 (484.3 q/ha) and SPV 2317 (484.3 q/ha) manifested significantly higher green fodder yield over CSV 21F (473.6 q/ha) and local Check PVK 809 (462.7 q/ha). For dry fodder yield, all the four test hybrid entries viz. SPH 1822 (180 q/ha), SPHG 1797 (179.3 q/ha), SPH 1752 (169.7 q/ha) and SPH 1794 (169.8 q/ha) showed significant superiority over CSH 13 (163.3 q/ha). Whereas, among test entries SPV 2388 (185.4 q/ha) recorded highest dry fodder yield among test entries and checks which was followed by SPV 2375 (182.2 q/ha) and SPV 2316 (181.5 q/ha). All these varietal entries also found significantly superior over CSV 21F (173.6 q/ha) and local check (162.7 q/ha) but at the same time these were at par with each other.

Allele Mining: A Technique for Crop Improvement

Prashant Gigaulia^{1*}, Prakash Narayan Tiwari^{1*}, Swapnil Sapre^{1*}

Molecular Biology and Biotechnology Center, Jawaharlal Nehru Krishi Vishwa Vidyalaya Jabalpur, Madhya Pradesh India (482004)

ABSTRACT

Innovations and new techniques implementation becomes necessary in today's scenario. In this changing climate condition and population bursting environment, sustainability in agriculture going to essential. Sustainability in agriculture can be possible only by new invention and innovation in agriculture and its practices. Allele mining can play an important role in sustainability in agriculture at molecular level. Alleles are the alternative form of DNA sequence at the same physical locus that may or may not express in different phenotypic traits. Allele mining is purely molecular technique and an important research field. Its main purpose is to identify the allelic variation of appropriate traits within genetic resource collections. It will help in development of superior and high yielding varieties by gathering of beneficial and important alleles from wide plant genetic resources, undisclosed allelic variants present in the world. Undisclosed alleles and wild varieties contain superior traits against biotic and abiotic stress. It mainly supports in tracing the beneficial alleles, identification of new haplotypes and development of allele-specific molecular markers for use in marker-assisted selection. True allele mining includes the analysis of non-coding intron and regulatory regions of the candidate gene(s), to analyze the sequence variations in the coding regions of the important agronomical genes. Alleles such as Sh (grain shattering), Rc (grain pericarp color), Wx for Granule-Bound Starch Synthase (GBSS) and GS (grain size) have led to significant improvements in rice crop.

The major approaches of allele mining are as Tilling, Eco-tilling, sequencing and association mapping. These methods are helpful in identification of sequence polymorphism for a gene in the naturally occurring in populations. Allele mining requires various bioinformatics tools viz., PLACE, plantCARE, TRANSFAC, JASPAR, MEME, Plantprom DB, DCPD, SCPD, BioEdit, ClustalW, Fast PCR etc. These tools used for identifying the nucleotide difference and prediction of amino acid changes which is responsible for encoding protein structure and its functions and provide vast sequence information to the public databases of the diverse crop genomes. This sequenced genomic information is used

3rd International Conference on “Global Initiative in Agricultural, Forestry and Applied Sciences for Food Security, Environmental Safety and Sustainable Development (GIAFAS-2021)”

for the identification and isolation of novel and superior alleles of agronomically important genes. In recent times, the methodologies and applications of allele mining along with the tasks associated have generated a lot of interest among researchers with highlight on the allele mining strategies for fast-tracking the process of allele finding and its utilization in molecular breeding programmes. Comprehending the enormous potential of allele mining, intensive allele mining efforts are ongoing in many international crop research institutes.

Keywords: *Tilling, Haplotypes Developments, Allele-Specific Molecular Markers, MAS.*

Adoption of Millets instead of Paddy: Save Water

Sneha Pandey

Department of Agricultural Economics, Indira Gandhi Krishi Vishwavidyala Raipur, Chhattisgarh

ABSTRACT

People across India are facing critical drought conditions and water shortages. As of June 25, 2019, nearly 65 percent of the country's reservoirs were running dry. India may lack overall long-term availability of fresh water resources. While India aquifers are currently associated with replenishing sources, the country is also major rice producer with a great need of water to support the commodity. The majority of the farmers are still dependant on growing **water intensive crops like rice**. Irrigation water, exclusive of precipitation and stored moisture, is required to meet the consumption rate of a crop during its growth period. But the amount of irrigation water required differs for each crop, not only because different crop need to survive different environments, but also because each crop has its own unique physical features. The rural Indian population is largely dependent on agriculture as its primary source of livelihood. Agriculture is one of the major contributors to India's GDP, with an 18% share; this population plays an integral role in the Indian Economy. Rice as grown in India is a water-guzzler, because farmers use on an average 15,000 litres to produce one kg of paddy, though water technologists at the Indian Agricultural Research Institute in New Delhi say no more than 600 litres is needed if proper water management techniques are followed. Given that 45 per cent of the country's total irrigation water is used solely for rice cultivation, the need to improve farming methods is imperative. Besides being wasteful, excessive use of water results in lower yields and adverse environmental effects such as soil salinity and water logging. Paddy yields in irrigated regions of Tamil Nadu, Punjab and Haryana range from five to six tonnes/ha, whereas in the high-rainfall areas of eastern UP, Bihar, West Bengal and Orissa, the yields are about 1.8 tonnes/ha. The main reasons for the poor yields are improper irrigation management and water logging.

60 per cent of the country can grow millets, under rain-fed conditions, on different kinds of soils. Millets on one acre saves six million litres of water. Millets are far superior nutritionally to rice and wheat. They have more protein, iron, calcium and fibre. As against rice, where the standing water produces greenhouse gases like methane, millets that are grown with legumes fix carbon in the soil. Millets are one of the oldest foods, these are the small-seeded hardy crops which can grow well in dry zones or rain-fed areas under marginal conditions of soil fertility and moisture. Millets are cultivated in low-fertile land, tribal and rain-fed and mountainous areas. These areas include Haryana, Uttar Pradesh, Chhattisgarh, Gujarat, Rajasthan, Madhya Pradesh, Maharashtra, Andhra Pradesh, Karnataka, Tamil Nadu and Telangana. Due to their short growing season, millets can develop from seeds to ready to harvest crops in just about 65 days. This highly beneficial characteristic of the millets is of vital importance in thickly populated regions of the world. If stored properly, millets can keep well for two years or beyond. Millets can not only grow in poor climatic or soil conditions and provide nutritious grain as well as fodder, but these can also very well fit into multiple cropping systems under irrigation as well as dry land farming due to their short growing season. The prolonged and easy storability of millets under ordinary conditions has given them the status of **Famine Reserves** and this feature is of great importance for India, as the agriculture of our country suffers from unexpected changes in monsoon.

It's very high time to ignore the cultivation of rice and replace it with millets. Along with nutrient, millets value added product can fetch the farmer's good price in market. The products of millets are gluten free, so it is widely adopted in urban areas. With the help of supply chain, farmers can take their produce to cities and can earn maximum profit.

Keywords: Sustainable agriculture, Water crisis, Paddy, Irrigation, Millet, Save water.

Effect of field and farm production system on biochemical parameters in chicken eggs from different breeds

P K Maddheshiya¹, Nazim Ali¹, Mahesh Kumar Bharti², Ahmad Fahim³, R. A. Siddique², Rajbir Singh¹, and D S Sahu¹

Dept. of Animal Husbandry, ²Dept. of Veterinary Physio. & Biochem, Dept. of LPM, ⁴Dept. of Animal Nutrition, Sardar Vallabh Bhai Patel University of Agriculture and Technology, Meerut-250110, Uttar Pradesh, India

ABSTRACT

Consumers are more and more interested in the health aspects of their food. Therefore, it is essential for egg production to be aware of factors affecting egg quality in poultry. Furthermore, changes in consumption features and the increasing interest of consumers in value for money products have to be considered. So, there is need to study the egg quality to popularize suitable breeds/ varieties producing highly acceptable, good quality eggs by the rural farmers. Present study was designed to study the egg quality among different breeds/varieties of chicken reared under field and farm production system because consumer's desire for healthier foods which has increased the demand for animal products containing low cholesterol and enriched fatty acids and conjugated fatty acid in diet. Based on biochemical analysis, total cholesterol content in brown layers (CARI Devendra) was lower than those in white layers (non-descript) in both farm and field condition. Total protein contents in brown layers T1 (CARI Devendra) was maximum than those in white layers T6 (non-descript) in field condition and in farm condition total protein in brown layers T5 (CARI Upkari) was maximum than those in white layers T6 (non-descript). But the glucose contents in brown layers T2 (CARI Hitkari) were lower than those T6 (non-descript) in both field and farm condition.

Keywords: Cholesterol, Protein, Glucose, Farm and field.

Agonists induced Acrosome Reaction in Buffalo Spermatozoa

Siddique R.A.^{1*}, Atreja S.², Khan M.A.¹, Singh K. P.³, Fahim A.¹ and Ali N.¹

1. College of Veterinary and Animal Sciences, SVPUAT, Meerut, India

2. Retd. Principal Scientist, Animal Biochemistry Division, National Dairy Research Institute, Karnal, Haryana, India

3. Veterinary Officer, Government Veterinary Hospital, Deorania, Bareilly, Department of Animal Husbandry, Uttar Pradesh

ABSTRACT

Capacitation and outgrowth reaction are two vital processes for achieving the fertilizing ability in spermatozoa. In our study acrosome reaction in capacitated murrah buffalo spermatozoa was elicited within the absence (control) or presence of LPC (positive control, 100g/mL) or inducers like Spermine-NONOate (100 μ M), progesterone (P4, 20 μ M), and estradiol (E2, 50 μ M). The greatest percentage of AR (53.86 \pm 0.30%) was induced by progesterone ($P<0.05$), followed by LPC (52.07 \pm 0.46%), 17-Estradiol (45.13 \pm 0.15%), and spermine-NONOate (43.85 \pm 0.42%). Progesterone phosphorylated a subset of proteins p32, p38, p45, p49, p80, and p105 substantially ($P<0.05$) higher than spermine-NONOate followed by LPC. In comparison to progesterone and LPC-induced phosphorylation, p69 was higher phosphorylated in spermine-NONOate treated spermatozoa. As a result, during the agonist-induced acrosome response of buffalo spermatozoa, the increase in protein tyrosine phosphorylation of the above-mentioned group of proteins was observed.

Effect of supplementation of *Agaricus bisporus* and *Saccharomyces cerevisiae* on hematological, biochemical parameters vis-a-vis growth performances in broiler chickens

Raj Kumar^{1*}, Nazim Ali², R. A. Siddique², D. S. Sahu², Ahmad Fahim² and Rajbir Singh⁶

SVPUAT, Meerut; 1, School of Agriculture Science, IIMT University, Meerut. U.P.

ABSTRACT

A 42-day study was conducted to investigate the effect of mushroom powder (*Agaricus bisporus*) and probiotics (*Saccharomyces cerevisiae*) supplementation on carcass characteristics and breast meat quality in broiler chickens. 360 day-old broiler chicks were divided randomly 8 dietary treatments with 3 replicates of 45 birds each in a completely randomized design. The experimental diets were designed as, T₁: control, T₂: 0.4% mushroom powder, T₃: 0.8% mushroom powder, T₄: 1.2% mushroom powder, T₅: 0.1% probiotics, T₆: 0.2% probiotics, T₇: 0.3% probiotics and T₈: 0.8% mushroom powder + 0.2% probiotics levels. The results showed that RBC, TEC and Haemoglobin level were observed significantly higher in the probiotics supplemented group T₇ in comparison to other groups ($p<0.05$). Hemoglobin concentration level was observed significantly higher in the probiotics treated group T₆ in comparison to other groups and least in control group. WBC (10³/ μ l), TLC (10⁶/ μ l), neutrophils (%) and Lymphocytes (%) were found to be higher in the combination of mushroom and probiotic supplemented group T₈ than other groups ($p<0.05$). Packed-cell volume (%) was observed significantly higher in the mushroom treated group T₄ in comparison to other groups and lowest level of Packed-cell volume (%) observed in control group T₁ ($p<0.05$). Mean corpuscular volume, MCH and MCHC were observed significantly higher in control group T₁ in comparison to all supplemented groups ($p<0.05$).

3rd International Conference on “Global Initiative in Agricultural, Forestry and Applied Sciences for Food Security, Environmental Safety and Sustainable Development (GIAFAS-2021)”

Similar trends were also observed in levels of Monocytes (%) and Eosinophils (%) and Basophiles (%) levels. The Serum protein (mg/dl), Albumin (g/dl), Globulins (g/dl) and Glucose (mg/dl) were observed significantly higher in the combination of mushroom and probiotics supplemented group than other groups. Total cholesterol (mg/dl), A.S.T. (U/L), A.L.T. (U/L), Uric acid (mg/dl) and Blood urea nitrogen (mg/dl) were found to be highest in control group T₁ than other supplemented groups. The highest calcium (mg/dl) was recorded in the combination of mushroom and probiotics group (T₈) and lowest in the control group (T₁), whereas phosphorus (mg/dl) was found to be highest in the probiotics supplemented group (T₆) followed by T₃, T₈, T₇, T₂, T₄, T₅ and T₁ group. Therefore, overall hematobiochemical indicators of health as well as growth performance of broiler chicken improved on supplementation of *Agaricus bisporus* and *Saccharomyces cerevisiae*.

Nanotoxicity impact and challenge for livestock

Deepika Chandra, Mahesh Kumar Bharti, R. A. Siddique, K. Ranjan, and Pankaj Kumar

SVPUA&T, Meerut, Uttarpradesh-250110, India

ABSTRACT

Nanomaterials have acquired prominence in technological advancements because of their tunable physical, synthetic and biological properties with improved execution over their bulk counterparts. Since quite a while nanoparticles (NPs) are produced by industries and utilized in domesticated animals fields of exercises. Production, use, removal, and waste treatment of merchandise containing nanoproducts are the primary cause of arrival of nanomaterials to the climate in its unique or changed structures. Due to that they found in both both aquatic and terrestrial conditions. Nanomaterials are ingested by animals, where they collect, prior to being eliminated. Due to their nano size nanomaterials go about as unfamiliar components inside the living body with their own physicochemical properties. So nanomaterials may meddle with the ordinary metabolic activities of the fatuous, developing animals, and grown-ups. It is important to mindful with regards to their immediate or roundabout hurtful consequences for living organisms. The purpose of this article is to distinguish the effect and gaps identified with the risk assessment of nanomaterials in animals particularly in domesticated animals area.

A need for adoption of climate resilient varieties of sugarcane under sub-tropical condition

Himanshu Rai and Nenavath Krishna Kumar Rathod

Division of Crop Improvement, ICAR-Indian Institute of Sugarcane Research, Lucknow (UP)

ABSTRACT

Due to the fast-burgeoning population, the country will require 35.6 million tons of sugar and nearly 520 million tons of sugarcane with average recovery of 10.75% to meet the demand by 2030. These estimates are based on the performance of present-day varieties and the prevailing climatic conditions. However, the country is facing low rainfall, severe winters and summers along with fast changing disease and pests which may hamper the productivity in coming years. Hence, the importance of sugarcane varieties which can perform under changing climatic conditions is gaining importance and is supposed to be the most crucial factor for the future sugarcane production. This will necessitate the need for screening and selecting varieties under changing climatic conditions. At present efforts are being made in this direction for evaluating varieties and genotypes for abiotic stress conditions (drought, water-logging and other stress) and recording of changing disease and pest scenarios under sub-tropical conditions being done. However, the efforts are much restricted in the crop with a complex breeding system. However, there is an urgent need to utilize modern biotechnological (Genetic Engineering and genome editing technologies such as CRISPR/Cas) and molecular tools to enhance the pace of breeding efforts. Recent development in sequencing part of the sugarcane genome is likely to be helpful in future to enhance breeding efforts. Some varieties developed in recent past such as CoLk 94184 (early maturity with good ratooning ability variety), CoPk 05191 (early maturity and stay green variety), CoLk 14201 (fight red rot disease and yield good quality jaggery) have shown high degree of tolerance to abiotic stresses such as drought and water lodging. There is a need to develop clones in higher degree of tolerance to biotic and abiotic stresses and transfer of genes responsible for mitigation of climate change from other species is required.

IMPACT OF RHIZOBIUM ON GROWTH, BIOMASS ACCUMULATION AND NODULATION IN *ALBIZIA PROCERA* SEEDLINGS FROM HIMACHAL PRADESH

Arti Ghabru* and Neerja Rana**

Department of Basic Sciences, College of Horticulture and Forestry, Dr. Yashwant Singh Parmar University of Horticulture and Forestry, Thunag, Mandi-175048, Himachal Pradesh, India

ABSTRACT

For the ecological balance and economic development of any nation forests are imperative. Studies on forest tree population structure over wide range of environmental conditions shows that physiological and genetic variations are associated with location or source of seeds. Biological nitrogen fixation (BNF) is the cheapest and environment-friendly procedure in which nitrogen fixing micro-organisms, interacting with leguminous plants, fix aerobic nitrogen into the soil. Nutrient enrichment of soils by nitrogen-fixing symbiotic bacteria present in legumes has been known for centuries. The present experiment was conducted with *Albizia procera* seeds of different locations inoculated with isolated bacteria of respective site and sown in poly bags. Results revealed that root inoculation of *A. procera* seedlings with *Rhizobium* inoculum was found significantly effective in improving growth, biomass production and nodulation over the control. Shoot length of inoculated *Albizia procera* plants varied in the range from 11.89 to 15.4 cm, root length 8.05 to 12.89, nodule number from 1 to 5 and legheamoglobin content from 4.8 to 6.3 mg/g. Significantly maximum root length (12.89cm), shoot length (15.4cm), nodule number (5) and legheamoglobin content (6.3 mg/g) was observed with seedling of Baddi, Solan. Root inoculation of *Albizia procera* seedlings with *Rhizobium* showed significant effect and found most effective in increasing symbiotic traits and growth performances by *Albizia procera* seedlings. These findings may give us a prospect to explore extensive research and also using *Rhizobium* as a cheaper substitute for urea.

Keywords: *Albizia procera*, *Rhizobium*, nodule, legheamoglobin content

Study on allelopathic aqueous extract of *Eupatorium adenophorum* for the management of *Parthenium hysterophorus* L. in lower temperate region of Tehri Garhwal Himalaya, Uttarakhand, India.

Vivek Kumar* B. S. Bisht

Department of Zoology, HNB Garhwal Central University, SRT Campus, Badshahithaul, Tehri Garhwal – 249 199.

ABSTRACT

Parthenium hysterophorus L. weed is a plant of global significance which is invading almost every part of the world. The weed is injurious to the health of human and livestock, damaging the biodiversity of native plants, harmful for agricultural crops production and it able to establish almost every climatic and geographical circumstance. The control of parthenium is very necessary because of its adverse nature. Physical, chemical, biological controlling methods are using to control this noxious weed. But researchers recommend controlling *Parthenium* by integrated biological management. In the present study further improving the research in this field by aqueous extract of plant *Eupatorium edenophorum* was tested for management of *Parthenium*. The different concentrations of 25%, 50% and 75% significantly suppressed germination of the target weed species. A 75% extract of *E. adenophorum* completely arrested the germination of the seed. Effect of different extract concentration on root and shoot length and seedling biomass was reported significant.

Key words: *E. adenophorum*, aqueous extract, Biological management, *Parthenium hysterophorus* L.

Physical characteristics and nutritional properties of honey obtained from rubber and moringa flora

Keerthana, B., R. Kanagarajan, K. Nishanthini, B. Anujaa, M. Vikaash, K. Hari Chandana.

Department of Entomology, Faculty of Agriculture, Annamalai University, Chidambaram, Tamil Nadu.

ABSTRACT

Honey was collected from the Indian honeybee (*Apis cerana indica*) reared on moringa and rubber flora. The physical properties include acidity, Electrical conductivity and the nutritional properties include carbohydrates, vitamin C, minerals such as sodium, potassium, phosphorus, calcium, zinc, manganese, copper, iron. The physical properties: pH measured for both the samples were acidic in nature, Rubber honey which recorded pH of 3.62 and Moringa honey recoded pH of 3.23, respectively. Gluconic acid, a product of glucose oxidation, is the main organic acid that is present

3rd International Conference on “Global Initiative in Agricultural, Forestry and Applied Sciences for Food Security, Environmental Safety and Sustainable Development (GIAFAS-2021)”

in honey; in addition, small amounts of acetic, formic, and citric have been found. These organic acids are responsible for the acidic (pH between 3.62 and 3.23) nature of honey. In case of electrical conductivity (EC), both the tested samples were within the standard limits, EC of rubber honey is 0.162 mS and for moringa honey is 0.282 mS respectively. Rubber honey has less carbohydrate and ascorbic acid than Moringa honey, which contains higher amount of carbohydrate and ascorbic acid. However potassium, phosphorus, calcium, zinc were present in higher quantity in Rubber honey whereas copper and iron content present was in lesser quantity in rubber honey. Moringa honey contains potassium, phosphorus, calcium, zinc and higher quantity of copper and iron respectively. Carbohydrates include monosaccharides (fructose and glucose) are the most important sugars and it also has smaller quantities of disaccharides, trisaccharides and oligosaccharides of honey and may be contributed to the most of the nutritional and physical effects of honey. Vitamin c is good for growth, it is involved in formation of collagen, absorption of iron, wound healing, maintenance of bones and teeth. Sodium is involved in the maintenance of osmotic pressure of body-fluids, regulates acid-base balance and transmission of nerve impulses. Potassium regulates muscle contraction particularly cardiac muscle, cell membrane function. Phosphorus is present on every cell on the body and it is mostly concerned with metabolic processes. Calcium functions as a constituent of bones and teeth, regulation of nerve and muscle function. Vitamins A and E metabolism and bioavailability are dependent on zinc status. It is needed for tissue repair and wound healing and plays important role in protein synthesis. Iron functions as haemoglobin in the transport of oxygen. Copper is the essential micro nutrient for the haematologic and neurologic systems. Manganese is a part of enzymes involved in urea formation, pyruvate metabolism and the galacto-transferase of connective tissue biosynthesis. The physical characteristics and nutritional properties of honey obtained from moringa and rubber flora were evaluated and compared in this study.

Keywords: *Apis cerana indica*, honey, physical characteristics and nutritional properties.

Metabolite profiling of underutilized legumes winged bean *Psophocarpus tetragonolobus* (L.)DC for sustainable development

Kunwar Sarvendra¹, Chandra Sekhar Mohanty¹, SC sati²

¹*: CSIR-National Botanical Research Institute, Lucknow-226 001, Uttar Pradesh, India

²* Department of Botany DSB Campus Kumaun University Nainital

ABSTRACT

The population of world increases day by day so demand for food is also increases, but the crops of food are becoming less on the earth that creates a big challenge for food security. The challenge of food security can be solve by the utilization of lesser known crops in the mainstream. The winged bean *Psophocarpus tetragonolobus* (L.)DC is a neglected and underutilized leguminous plants having moisture content (9.5 to 10.5%), ash, (3 to 5.5 %), fiber (10.5 to 11.5 %), protein (31.4 to 38.7%), fat (15.5 to 20.6 %), carbohydrates (23.1 to 32.1 %), oil (18 to 20.5%) and energy value, 417.5 to 440.7 Kcal on dry weight basis. Metabolites profiling is a technique that play a important role to screen out better genotypes on the basis of metabolites. Gas chromatography-mass spectrometry analysis of winged bean seed oil reports Oleic and linoleic acids as a major unsaturated fatty acids. Winged bean oil (20%) shows antioxidant activity due to presence tocopherols and tocotrienols. The nutritional and oil quality of winged beans are very similar to soybean. Not all parts of soybean are eaten, but all parts of winged bean from the roots to the seeds are eaten. Principal component (PC) analysis applied on the metabolites of different accessions of winged bean to facilitate selection of the most relevant variables.

Keywords: Food security, GC-MS, Metabolite profiling and Principal component

Combining ability and heterosis studies for agro-morphological and yield traits in hulled barley (*Hordeum vulgare* L.) under north-western Himalayan conditions

CHETAN GUPTA^{1*}, VIJAY RANA^{1,2}, AMIT RANA¹ AND PRIYANKA¹

Department of Genetics and Plant Breeding, Rice and Wheat Research Centre, CSK, Himachal Pradesh Krishi Vishvavidyalaya, Palampur (H. P.), India-176062

ABSTRACT

Barley is one the most important crops worldwide grown mainly for food, feed and drinks. The main aim of this study was to assess the combining ability of barley parents and estimate the inheritance pattern for some agro-morphological

3rd International Conference on “Global Initiative in Agricultural, Forestry and Applied Sciences for Food Security, Environmental Safety and Sustainable Development (GIAFAS-2021)”

and yield traits for future breeding programmes. The experimental material comprised of 28F₁ crosses developed by crossing 8 commercial varieties/germplasm/local lines as per diallel mating design (8×8, excluding reciprocals) in *Rabi* 2018-19 and further evaluated in Randomized Block Design with three replications during *Rabi* 2019-20. Combining ability analysis revealed significant differences for all the traits studied indicating wide genetic variability among the genotypes and prevalence of additive variance for the all the traits. GCA effects indicated that parents VLB 118, HBL 804, BHS 380 and HBL 316 were overall good general combiners for agro-morphological and yield traits. Twelve cross combinations *viz.*, HBL 713 × BHS 380, HBL 713 × BHS 400, HBL 713 × Losar, HBL 316 × HBL 804, HBL 316 × BHS 380, HBL 316 × BHS 400, HBL 804 × BHS 380, HBL 804 × VLB 118, BHS 380 × BHS 400, BHS 380 × Local Ropa, VLB 118 × Local Ropa and VLB 118 × Losar were identified as best on the basis of seed yield together with other component traits. On the basis of standard heterosis, crosses *viz.*, HBL 713 × BHS 380, HBL 804 × BHS 380, HBL 804 × VLB 118, BHS 380 × BHS 400, BHS 380 × Local Ropa and VLB 118 × Losar were identified as promising for agro-morphological and yield traits and are expected to throw transgressive segregants. Therefore, results from the present study will be useful in formulating future hybridization breeding programs for barley improvement.

Doubling the farmers income through innovative approaches

Meenakshi attri, Lalicheti Sagar, Monika Menia, Jyoti Sharma and Swati Mehta

Division of Agronomy, Sher-e-Kashmir University of Agricultural Sciences & Technology of Jammu

ABSTRACT

Under Indian context, the prosperity of a country depends upon the welfare of farmers and majority of the Indian farming communities follow traditional norms of agriculture which support their livelihood. Doubling farmers real income by 2022 is a goal established by the Hon'ble Prime Minister of India. Production and productivity increases in agriculture alone will not ensure doubling farmers' income. Meeting market demands requires a shift in mindset from “Farm to fork/plate” to “Fork to Farm”. Secondly, market- intelligence must be made available to producers using innovative partnerships and communication technologies. Lastly, the changing climate has increased vulnerability of 137 million small farm holders. Changing climate, increasing weather variability, changing food habits, non availability of quality seeds, delay water irrigation, reduced soil fertility, excessive use of chemical fertilizers, water scarcity and land degradation all pose severe challenges for food and nutritional security for India's growing population. Increasing cost of cultivation, low productivity and lack of remunerative market prices for farmers result in low incomes and poverty for small and marginal farm holders. New innovations to collectively benefit small farm holders through a holistic value chain by adopting science-led, climate resilient and market responsive development has to be our “New Mantra” to benefit farmers. Two key focuses of a strategy to double farmers' income by 2022 are reducing rural poverty by tapping food demands from the growing Indian population. Also, finite natural resources limit the potential for smallholders to meet the demand and are exacerbated by land fragmenting, and reduced water quantity per farmer. Therefore, there is an urgent need of transformation in agriculture production combined with integrated farming system (IFS) approaches, investments in agricultural research and development, adoption of Good Agricultural Practices (GAP), conservation agriculture technology, implementation of farmers friendly policies, judicious use of available resources and inputs, along with improved market and transportation facility, minimum support price (MSP) reform, supported by adequate and timely availability of bank credits. It has been reported that a rise in MSP will raise farmer income by 13-26 per cent. Smart farming and credit supporting smart farming are other possible strategies towards doubling farmer's income.

Keywords: *Smart farming, doubling farmer's income, climate resilient, minimum support price*

CHEMICAL WEED CONTROL IN MAIZE (*Zea mays* L.). A REVIEW

M.S NA ALLAH, GURPREET SINGH AND SANDEEP MENON

*DEPARTMENT OF AGRONOMY, LOVELY PROFESSIONAL UNIVERSITY,
PHAGWARA PUNJAB INDIA*

ABSTRACT

Maize (*Zea mays* L.), is a member of the grass family called Poaceae. It's one of the most important cereal crops grown as food for human and feed for animals. Significant yield losses were reported in maize due to poor soil fertility, drought, pest, and diseases, weed interference, and other factors in which weeds possess a serious threat to crop productivity. In India yield losses ranging from 18-65% in maize have been recorded due to weed infestation. The critical period for weed competition begins 3 to 4 weeks after corn planting, with acceptable yield loss of 5 to 10%, so with rising labor costs and the need for quick weed control in a number of situations. Herbicides are effective tools for

3rd International Conference on “Global Initiative in Agricultural, Forestry and Applied Sciences for Food Security, Environmental Safety and Sustainable Development (GIAFAS-2021)”

controlling weed infestations, and their use is growing globally. In this review, an investigation of the literature has revealed a significant reduction in cost of using herbicide in weed management. Research has proven that the use of herbicide reduced weed population by up to 80% in maize crops. It was reported that pre-emergence and post-emergence application of selective herbicide gave excellent control of weed in maize crops. This has been a success in different agroecological zones and serves as a vital tool in weed management.

Keywords: Maize, Weed, Herbicide, Yield, weed flora. Weed density, weed dry weight

Ethno-botanical Diversity of Wild Edible Fruits of Central Manipur—An overview Wahengbam Uniqueson Singh^{1*}, Dr Suneeta Singh² and Dr Anil Kumar Saxena³

Department of Horticulture, School of Agricultural Sciences, Department of Soil Science, SGRR University, Dehradun- 248 001, Uttarakhand, INDIA

ABSTRACT

Broccoli is an edible green plant that is classified in the Italica cultivar group of the species *Brassica oleracea*. They are rich in vitamin C, dietary fiber and also contain glucoraphin, sulforaphane, selenium and isothiocyanates. Broccoli is also an excellent source of indole-3-carbinol. These constituents present in broccoli are known to be very popular since they possess several anti-cancer properties and benefits. These anti-carcinogenic compounds have a wide variety of uses and benefits for the treatment of various diseases and disorders. Broccoli is widely used in the treatment of several forms of cancer and also treats other neural disorders. The therapeutic potential of broccoli has been explained under its role in cancer, diabetes and other diseases. In the treatment of cancer, most of the constituents or the phytochemicals of broccoli such as brassinin, isothiocyanates, indole-3-carbinol etc. have been proved to be effectively beneficial. Even selenium plays a very important role in cancer prevention. The antioxidant activity of broccoli is induced by other phytochemicals such as glucosinolates, glucoraphin and sulforaphane. Sulforaphane in broccoli sprouts also has the potential to cure neural disorders such as Alzheimer's disease and Parkinson's disease. It is also used to bring about cure in asthma and diabetic patients. Flavonoids have the effect of reducing the risk of diabetes. Therefore sulforaphane is widely

The study was carried out to document the wild edible fruits of central Manipur with respect to their ethno-medicinal uses and socio-economic importance among the rural people. Altogether 49 species of diverse fruits were recorded which are represented by 22 families. Among all, Rosaceae was the most used family consisting 10 species followed by Moraceae and Rutaceae by 7 species, Phyllanthaceae by 4 species, Anacardiaceae, Arecaceae and Rubiaceae each by 2 species and rest all one species each. Some examples of wild edible fruits found in Manipur are wild olive, Indian gooseberry, wild apple, cluster fig, star fruit, jamun, pomelo, drooping fig, tamarind, etc. In terms of socio economic importance of these fruits, most of the wild fruits are used for construction of houses, firewood, fodder for domestic animals and charcoals in rural life. These fruits are also used to make dyes for use in traditional handicrafts and to make oils. Most of these fruits are available in the local market, in the price range of Rs. 20 to Rs. 100 per kg. In spite of these versatile uses, these fruits have not yet been properly documented. Hence, there is urgent need to document these valuable species before they become extinct.

Keywords: Wild fruits, ethno-medicinal, Rosaceae, Indian gooseberry, jamun

BASKETRY PRODUCTION FROM BAMBOO BY RURAL WOMEN IN KALKA REGION (HARYANA)

Lalita Rani¹ and Nisha Arya²

¹*Krishi Vigyan Kendra, Kurukshetra-136118*

²*Department of Textile and Apparel Designing, COHS, CCSHAU, Hisar-125004*

ABSTRACT

The present study based on economically deprived community of the *Bhanjdas* of *Bargodam*, *Kalka*, and *Bowana* depends on bamboos from the surrounding forest areas for sustenance. Actually, these communities are traditionally practicing of the bamboo basketry from the three generations. Their earning depends upon the growth of the bamboos in the forest areas. The earning could be enhanced further if they market the produce themselves instead of entrusting the job to money lenders, who charge exorbitant commission. The present study was conducted on 60 households in Kalka region (Haryana) twenty from each village. Their monthly earnings from making baskets of different sizes ranged from

3rd International Conference on “Global Initiative in Agricultural, Forestry and Applied Sciences for Food Security, Environmental Safety and Sustainable Development (GIAFAS-2021)”

500 rupees for baskets of the largest size to 600 rupees for baskets of the smallest size. Further, 15 days of employment was created every month from basket making. The study also indicated that direct selling of baskets by villagers could increase the monthly earnings of the community by 99 per cent to 140 per cent. These rural communities and government forest departments have struggled over the control of forest resources. State bureaucracies have prevailed in circles of law and political power in their attempt to dominate nearly one-quarter of India's land area, but forest villages, because of their traditional rights, number, and proximity, have maintained their position as the principle resource user.

Keywords: Economically deprived communities, traditional basketry, employment, bamboo forest

Value Addition of Fruits and Vegetables: Challenges and Opportunities

Ritu Pandey and Sharad Pandey

Department of Agriculture, Himgiri Zee University, Dehradun (Uttarakhand)

ABSTRACT

Food Security is one of the biggest challenge to the ever growing population of the world. In addition to increasing the agricultural productivity, it is equally vital to produce quality produce to address the issue of malnutrition among the masses. As per Food and Agriculture Organization, a 70% increment in food production will be needed to feed the world population which would reach 9 billion by 2050. Inefficient supply chain management makes the agricultural produce more vulnerable to post harvest losses in terms of both quantity and quality. The main reasons responsible for post-harvest damage are physical (mechanical injury), physiological (chilling injury, witting, withering) and some biotic (fungi and bacteria) factors. Post-harvest losses reaches its height when these three factors get combined. Though there has been increase in the yield of agricultural crops, yet 20-50% post-harvest losses in developing countries and 10-15% in developed countries becomes the prime reason for not providing food and nutritional security to all. Fruits and vegetables are essential supplements to balance the human diet as they provide the required nutrition, vitamin, and roughage. Value addition to these agricultural commodities not only results in high market value but also restores the nutritional quality. Low cost technologies for value addition available to the farmers at their doorstep will not only raise their income but also reduce the time and money incurred in transportation of produce to the potential market. Thus, value addition is a profitable venture in India. There is a vast scope of value addition of fruits and vegetables in different consumable forms for all groups or ages of consumers. The target of the government of India is to increase the processing of these commodities to more than 10% by 2025. So, it is the responsibility of all agriculturalists to join hands with the government to achieve the set goal.

Keywords: Agriculture, fruits, vegetables, value addition

Role of Information Communication Technologies (ICTs) in Dairy Farming Management

Pooja Karki ¹ and Mohammad Aslam Ansari ²

Department of Agricultural Communication, G. BP. University of Agriculture & Technology, Pantnagar-263145, Uttarakhand, India

ABSTRACT

Dairy farming plays an important role in socioeconomic development of rural households in the country. About 80 million rural household are engaged in milk production with very high proportion being small, marginal farmers and landless. Agriculture and livestock sector have a symbiotic relationship, in which the agricultural sector provides fodder, feed for the livestock, and while animals provide milk, draught power and manure for various agricultural operations. Although India has the largest number cattle and buffalo population in the world, the milk productivity per unit of livestock is quite low. Globally, India is not only one of the top producers of milk in the world, but also the largest consumer of milk and milk products.

Information Communication Technologies (ICTs) have emerged as essential tools for communication, education, entertainment, and also for facilitating e-governance and online shopping. ICTs are playing a critical role not only in transforming dairy farm production management systems but also in decision support system by fulfilling their diverse information needs and expectations. Now, there is an increasing tendency among different stakeholders in dairy farming sector to rationalize, digitize and automate various dairying processes for increasing the efficiency both for economic benefits as well as quality assurance. It is expected that these new technologies (Internet, mobile, social media, etc.) will fill the gaps in efficient production systems and supply chain management. Driven by the ICTs, the main factors which will contribute significantly in this transformation of dairy farming are: timely access to desired information, informed decision making, Operational management, Mobile apps for quick interaction, access to market and market intelligence,

3rd International Conference on “Global Initiative in Agricultural, Forestry and Applied Sciences for Food Security, Environmental Safety and Sustainable Development (GIAFAS-2021)”

etc. The benefits of ICT adoption by farmers range from quick opportunity to information about programmatic interventions, improving market access and efficiently manage operational difficulties and making dairy enterprises more competitive and successful. The use of ICT as a farming extension tool by the dairy farmers has the potential to transform the dynamics of dairy farming and improve farmers’ outputs and incomes leading to increased welfare.

Keywords: dairy, management practices, and ICT

Productivity of quality fodder of oat as influenced by integrated nutrient management techniques

Manpreet Kour^{1*}, B. C. Sharma¹, A. K. Dixit², N.P.Thakur³, Rohit Sharma⁴ and Parshotam Kumar³

Division of Agronomy, IGFRI, Jhansi, Farming System Research Centre, Advance Centre for Rainfed Agriculture, SKUAST-Jammu, J& K, India

ABSTRACT

Fodder and forages are mainstay for animal prosperity and productivity and is backbone of livestock sector. But deficiency in both green and dry fodder has decreased the livestock productivity in India. To narrow down the gap of demand and supply new technologies and techniques should be intervened to promising high potential fodder crops. The oat is an important high yielding, succulent and nutritious fodder crop. Whose fodder production can be enhanced by adding more fertilizers. But their excess use may cause adverse impacts on environment. Thus a sustainable fertilization strategy in form of Integrated Nutrient Management should be adopted which may increase the growth characters, fodder yield to the tune of 25-30%, besides increasing quality, uptake of fodder and profitable by incurring more net returns and benefit cost ratio.

Key Words: Oats, FYM, Vermicompost, PSB, Trichoderma, Green Manuring, Azotobactor

Agronomical strategies for year round fodder production and conservation of surplus fodder for dairy animals under North-west Himalayas

Manpreet Kour¹, Rajeev Singh, B.C.Sharma, N.P.Thakur, Suheel Ahmad, Sheeraz S. Bhat and Rohit Sharma

Shere-Kashmir University of Agricultural Sciences and Technology, Chatha, Jammu

ABSTRACT

There is huge deficit of both green (63%) and dry fodder (24%) availability in our country. J&K is also deficient in green (54%) as well as in dry fodder (67%). This problem aggravates during the lean periods of May-June and November-December which affects the health and productivity of animals. This paper aims at bridging the gap between supply and demand of fodder and aim to provide sufficient quantity of quality fodder to the livestock throughout the year by the means of year round alternative sources of fodder, like perennial grasses (napier grass, guinea grass, deenanath grass), annual fodder species (sorghum, bajra, oats and maize) fodder trees (*Grewia optiva*, *Leuceana leucocephala*, *Albizia lebbeck*, *Morus alba* and *Bauhinia variegata*), so that the milk productivity as well as animal health may be maintained. Further to ensure the year round availability of quality fodder it is necessary to focus on minimizing the fodder wastages and further to overcome the shortage of fodder during lean period through fodder conservation techniques of silage and hay making.

Keywords: Hay making, livestock, productivity, silage, round the year fodder production.

Organic farming with residue-free production

Neeraj Kumar

Department of Entomology, Jawaharlal Nehru Krishi Vishwa Vidyalaya, Jabalpur, Madhya Pradesh, India

ABSTRACT

Staying healthy is the need of the hour in today's world, which has encouraged many of us to prefer a health-friendly diet. Consumption of residue-free and organic products has increased substantially. This has created an opportunity for young entrepreneurs to enter the residue-free framing sector. Organic biocides and bio fertilisers are used to protect and enhance the growth of crops in residue-free farming. Using modern agri-technologies such as greenhouses and drip

3rd International Conference on “Global Initiative in Agricultural, Forestry and Applied Sciences for Food Security, Environmental Safety and Sustainable Development (GIAFAS-2021)”

irrigation systems, fertigation, integrated fertiliser management, integrated pest management, residue-free production, rainwater harvesting, high-density plantation and contour farming, as well as the utilisation of wasteland, etc., it is relatively easy to maintain the quality of the produce. The concept of farm to fork primarily relates to reducing/minimizing the human handling of the product. In order to achieve customer expectations, residue-free farming must be included into the farming process. It's the use of natural fertilisers such as cow dung and earthworm manure instead of chemical fertilisers. This one change itself accounts for a big difference in the residue content of the product and takes it a notch further in making it residue-free. As long as agriculture has relied on chemical fertilisers, it has had a negative impact on the environment, which can lead to damage to agricultural products as well as people's health if they eat those products thereafter. Abuse of chemical fertilisers has caused soil health to deteriorate, reducing the nutritional value of the product and jeopardizing consumer health. As a result, non-residual fertilisers should be used as much as possible. Increasing the health benefits, freshness, and lifespan of the product would be a result of this. People are now more aware of the benefits of eating fresh and residue-free food due to the rapid development and greater awareness in the health segment. Adopting the practise of residue-free farming will help facilitate this transformation. It's an area where the food produced is pure, healthy, and nutritious. Environmentally safe and chemical-free product is grown without the use of harmful chemical fertilisers.

Keywords: eco-farming, residue-free production, health, longevity, safe eating, nutritious, eco-friendly.

To study the decision-making behavior of farmer and farm women in management activities in Kadapa district of Andhra Pradesh, India

P. Laxmi Prasanna¹, B.P. Mohapatra², R.K. Mishra³

Department of Extension Education, Department of Agriculture Economics, Agricultural College, Orissa University of Agriculture and Technology, Bhubaneswar.

ABSTRACT

The research was conducted to analysis of different animal husbandry management of farmer and farm women in YSR Kadapa district. The research was conducted in YSR Kadapa district of Andhra Pradesh. Ex post facto research design was used for collecting data. Data were collected with personal interview method. A Total 120 respondents were selected randomly from the selected five villages, consisting of 60 respondents were male farmers, 60 respondents were farmwomen. Farmer and farm women were interviewed separately with pre structured interview schedule. It has been observed that most of the works related to the animal management works performed by the female farmer. Most of the activities related to the buying selling animal and dairy produce and financial activities performed by the farmer. Most of the decisions related to the financial aspects taken by male farmer. Most of the activities like cleaning, feeding, collecting milk, preparation of feed performed by female farmer. Farm women are not accessible to take the decisions and participation in financial aspects due to low exposure to community, low education levels, heavy work burden. The study has recommended that there is a need to empower and educate the farm women to active participation in financial, educational, community development activities and inculcate decision making abilities which will empower farmwomen to self reliable, confident and imparting knowledge regarding different technical aspects in farming.

Keywords: Animal husbandry activities, decision making, male farmer, farm women, participation, Kadapa.

Smart Farming: The Future of Agriculture

Mamta Patel¹, Sneha Pandey² and Sanjana Sharivastava³

1, & 2 Department of Agricultural Economics, IGKV, RAIPUR (492012)

3 Department of Agriculture Extension, JNKVV, JABALPUR

ABSTRACT

Smart farming" is an emerging concept that refers to managing farms using technologies like IoT, robotics, drones and AI to increase the quantity and quality of products while optimizing the human labor required by production. Smart farming is much more efficient than traditional methods. Smart farming is much more efficient than traditional methods. The IoT-based system can monitor agricultural land — soil moisture, humidity and temperature — with the help of sensors and mechanised irrigation practices. For instance, a farmer can monitor his field from anywhere and get an alert as and when the soil moisture level goes down, prompting him to initiate irrigation. Here, both the digital and physical infrastructure work together, but small farmers in villages and cities face difficulty in pairing the two Agri start-ups can reach out to all these farmers and make it a viable and cost-effective solution. The government's free app, Kisan Suvidha, provides farmers information on current weather, market price, dealer info, plant protection, and more. The

3rd International Conference on “Global Initiative in Agricultural, Forestry and Applied Sciences for Food Security, Environmental Safety and Sustainable Development (GIAFAS-2021)”

app also shares market prices of commodities at the nearest location and the maximum price in the State and India. There is also ISRO's Geo-platform, Bhuvan, which provides valuable data on the plantation, pest surveillance and weather. The use of such information from these apps can be optimised by the farmer. As Covid-19 conformities and protocols continue to restrict the labour force, intelligent technologies like precision agriculture and drones can help manage the farms. There are over 1.25 lakh panchayats with broadband access at present. Government measures like direct purchase from farmers and farmer producer organization besides online buying through e-Nam portals and private e-mandis like Agribazaar, are positive initiatives Agri-tech start-ups, by analyzing various data, can help farmers get crop insurance and institutional credit. These tech agencies and government programmes will not only help sustain India's agri sector but will also drive it towards significant growth even in the post-Covid era.

Keywords: Smart Farming, Drones, E- Nam, Agribazar

Expression Dynamics of MRP genes during peri-impantation period in Buffaloes

Rajni Kumari, Rakesh Kumar*, S Dayal, Rohan Raman, PC Chandran, PK Ray, A Dey, Kamal Sarma

ICAR- Research Complex for Eastern Region, Patna

ICAR- Research Complex for North Eastern Hill Region, Umiam

ABSTRACT

The present study was conducted to examine expression profiling of three interferon stimulated genes (ISGs) - ISG 15, MX 1 and MX 2 and two chemokine genes- CCL8 and CXCL10 during peri- implantation period in progesterone assay confirmed pregnant dairy buffaloes and identify most appropriate biomarker amongst them for use as an early pregnancy biomarker. For this, transcriptional abundance of all these five genes was determined by SYBR green chemistry based quantitative real time reverse transcription PCR in whole blood of Murrah buffaloes on day 12, 15, 18 and 21 post artificial inseminations (AI). Principal Component Analysis (PCA) was also performed to observe expression dynamics of these MRP genes and identify correlation between them. PCA bi plot between five MRP genes at different days of interval for pregnant buffalo showed that ISG 15, CCL8, CXCL10 and MX 2 are dominated with principal component 1 (Dim1) that explained maximum variation 85.2%. Gene MX1 alone is dominated on principal component 2 that explained minimum variation 12.2% of the data sets. ISG 15, CCL8 expression was observed in latter days i.e., 21 days (D21) of pregnancy and both ISG 15, CCL8 are highly correlated too. Same way, peak mx2 and cxcl10 expression was observed in latter days i.e., 21 days (D21) of pregnancy and they are also highly correlated. Peak of MX1 expression appears in 18 days (D18) after pregnancy. MX 1 didn't show correlation with any of the studied MRP gene. It was observed that though peak of MX 1 is expressed at earliest i.e day 18 post AI, but it's down regulation post day 18, in whole blood disqualifies as most appropriate marker. Based on the expression profile of these MRP genes, CCL8 gene posed to be most appropriate marker amongst all, because of its consistent expression during the studied period. We also studied effect of parity on the expression profile of CCL8 gene and found that expression level of this biomarker gene remained unaltered in either of primiparous or multiparous animal.

Effect of Electromagnetic Radiation (1800 MHz) on Germination Percentage, Morphological Characteristics, Lipid Peroxidation and Antioxidant System in *Trigonella foenum-graecum* Test System

Surbhi Sharma¹, Shalini Bahel² and Jatinder Kaur katnoria^{1*}

Department of Botanical and Environmental Sciences, Department of Electronics Technology, Guru Nanak Dev University, Amritsar (Punjab)-143005, INDIA

ABSTRACT

Over the past year, people have been exposed to a wide range of electromagnetic radiations (EMRs) irradiated by different gadgets like radar, broadcast antennas, computers, satellites, televisions, wireless internet and wireless local area networks (LANs). Apart from these, exposure of human beings to non-ionizing radiations of radiofrequency spectrum used in mobile phones and other electronic equipment has become unavoidable these days. The Global System for Cell Telecommunications (GSM) mobile phones with radiation frequencies (RFs) spanning between 880 and 1800 MHz have been reported to be extensively utilized as the most common RF transmitters in our everyday lives. Considering this, the present study was designed to evaluate the effects of electromagnetic radiations at frequency 1800 MHz and power density 10.0 dBm (0 h, 0.5 h, 1 h, 2 h, 4 h and 8 h) on percentage germination, root and shoot length, fresh and dry weight, protein content, lipid peroxidation and antioxidative system in *Trigonella foenum-graecum* test system. It was observed that seeds of *Trigonella foenum-graecum* upon exposure to EMRs at 1800 MHz have shown

the percentage germination at 4 h as 93.33% and at 8 h as 83.33%. The fresh weight and length of the root and shoot decreased at a higher exposure period whereas the dry weight did not show a significant change at varied exposure periods. EMRs led to a significant increase in the antioxidative activities in both root and shoot system of *Trigonella foenum-graecum*. The specific activity (mol UA/mg fresh protein) of ascorbate peroxidase (APX), superoxide dismutase (SOD) and glutathione-S-transferase (GST) was shown to be increased significantly in root and shoot at 4 h and 8 h exposure. EMRs exposure to the *Trigonella foenum-graecum* seedlings also shown to increase the malondialdehyde content (MDA) content in terms of the lipid peroxidation at 4 h (1.65 $\mu\text{mol/g}$ fresh weight) and at 8 h (1.71 $\mu\text{mol/g}$ fresh weight) exposure periods. The present study revealed the induction of oxidative stress by EMRs in *Trigonella foenum-graecum* seedlings upon exposure at different treatment durations.

Keywords: Catalase, Ascorbate peroxidase, lipid peroxidation, glutathione-S-transferase, electromagnetic radiations

Development and nutritional evaluation of β -carotene rich Idli prepared using curry leaves powder

Sonia*, Varsha Rani and Sangeeta C. Sindhu

Department of Foods and Nutrition, I.C. College of Home Science, Chaudhary Charan Singh Haryana Agricultural University, Hisar-125004 (Haryana), India

ABSTRACT

Curry leaf (*Murraya koenigii*) is a marvelous leafy spice having culinary, medicinal and nutritional properties. It is very rich in β -carotene (7663 μg). Retention of β -carotene was witnessed up to 80-90 per cent after steam cooking. This study was aimed to standardize the process of development of *idli* using various proportions of curry leaves powder (CLP). The control products *idli* were prepared using rice: black gram dhal (2:1) batter and all other required ingredients. Rice: black gram dhal (2:1) batter were substituted with 5, 7.5 and 10 per cent of curry leaves powder in experimental (Type-I, Type-II and Type-III) *idli*. The sensory evaluation in terms of colour, taste, texture, aroma and appearance of the developed *idli* was done using 9-point hedonic scale by the 25 semi-trained judges. As per the scores given, the overall acceptability (OAA) of *idli* was calculated and it was found that *idli* prepared by supplementing 7.5 per cent of CLP was most liked by the judges followed by T₁ *idli*. However further increase of CLP was affecting the sensory scores. The amount of β -carotene in control *idli* was found to be 35.08 $\mu\text{g}/100\text{g}$, which was varied from 5240.06 to 10445.16 $\mu\text{g}/100\text{g}$ within experimental *idli*. Soluble dietary fibre content of experimental *idli* was ranged from 4.25 to 5.25 per cent, whereas, T₃ *idli* contained maximum amounts (13.51 %) of insoluble dietary fibre followed by T₂ (11.55 %) and T₁ (10.54 %) *idli*. The available calcium, iron and zinc content in experimental *idli* were ranged from 44.81 to 83.57, 0.15 to 0.28 and 0.14 to 0.20 $\text{mg}/100\text{g}$, respectively. Utilization of curry leaves in daily products should be promoted to get the benefits as these are rich in β -carotene and may improve the sub-clinical deficiency of vitamin A in vulnerable group.

Keywords: Curry leaves, *idli*, sensory, acceptability, β -carotene

Pharmaceutical Potential of Cordia macleodii Hook F. Thomson and Soyimida febrifuga (Roxb) A. Juss and its Conservation Strategies

Anish Kumar Singh¹ Dr. K.K. Chandra²

Dept. of Forestry, Wildlife & Environmental sciences, Gurughasidas Vishwavidyalaya (A Central University) Bilaspur, (C, G) - 495001, India

ABSTRACT

Cordia macleodii Hook F. Thomson (common name - Dahiman, Dhahipalas) and *Soyimida febrifuga* (Roxb) A. Juss (common name - Rohina or Indian red tree) are two rare and highly used medicinal plants of dry deciduous forests of Central and Peninsular India. Tribal communities use both species to cure several diseases and, therefore, exploit the following destructive methods. These resulted in the exponential decline in the population of these species in their natural habitat. The phytochemical evaluation of these plants also confirms their significance in pharmacy. Traditionally, it has been conventionally used for treating malaria and used as a gargle in stomatitis and has aphrodisiac, anthelmintic properties, snake bit, wound healing, blood purification, and ulcer and to neutralize the adverse effect in

alcoholic person, jaundice, flu, fever, cough, asthma, astringent and hepatic stimulant, tuberculosis, bronchitis and in inflammation and wound treatments. Biotic pressure highly affects the plants, resulting in difficulties in seed formation and regeneration under natural conditions. For conservation of these plants, the standardization of propagation techniques, nursery production, and plantation to forest areas needs standardization. The issue of plant production to these plants due to poor seed germination, high seedling mortality are primarily associated with these plants. In this paper, we have highlighted the potential of pharmaceutical characteristics of these plants and their conservation strategies, suggesting approaches of improving seed viability, germinability, and plant production by hormonal treatments. More attention is required to enhance knowledge, particularly on plant acclimatization and adaptation of these plants outside the forest through maintaining higher regeneration and plant establishment for their use sustainably.

Keywords: Medicinal plants, seeds germination, pharmaceutical activities, conservation, sustainability.

Growth and Yield Performance Analysis of Long Day Garlic Genotypes at High Altitude of Uttarkhand

Raj Narayan¹, Sovan Debnath², Arun Kishor,² D.B. Singh,³ O.C. Sharma,³ and S.K. Singh¹

¹ICAR-ATARI, Zone-II, Jodhpur, CAZRI Campus, Jodhpur (Raj.)-342005.

²ICAR-CITH RS, Mukteshwar, Nainital (UK).

³ICAR-CITH, Srinagar (J&K)

ABSTRACT

Total of 17 genotypes of long day garlic were tested of which 8 under AVT-I and 9 under AVT-II trials of AINRP (Onion & Garlic) during rabi 2018-19. All the genotypes of both the trials were planted in RBD with three replications at a spacing of 15x10 cm² in 2.0 x 2.0 m² plot at Research Farm of ICAR-Central Institute of Temperate Horticulture Regional Station, Mukteshwar, Nainital (UK) which is situated at an altitude of 2171masl. The genotypes were evaluated for their growth, yield and quality traits. In general, genotypes in both the trials exhibited significant differences for various traits under study.

Among the eight genotypes of AVT-I trial were characterized for various economic parameters, GN-17-25 was found top ranking in terms of bulb yield 4.45 Kg/plot (197.77q/ha) followed by GN-17-21 and GN-17-08 with 2.71 Kg and 2.06 Kg bulb yield/plot (120.44 q/ha and 91.55 q/ha), respectively. The highest average bulb weight of 40.06g, 38.53g and 20.66g were recorded in GN-17-21, GN-17-25 and GN-17-12, respectively. The genotype GN-17-21 and GN-17-25 also exhibited highest average clove weight of 6.78g and 6.73g, respectively. The total soluble solid content was found maximum in genotype GN-17-08 (41.60⁰ Brix) followed by GN-17-19 (40.36⁰Brix) and GN-17-03 (40.20⁰Brix). The weight loss percentage during two months of storage after the harvesting of bulbs was observed minimum of 2.44 % in GN-17-25 whereas it was recorded maximum (7.37 %) in GN-17-03 at room temperature in Mukteshwar conditions.

Likewise, among the nine diverse genotypes of long day garlic tested in AVT-II trial, Among the lines, GN-15-78 produced highest bulb yield of 5.29 Kg/plot (235.11q/ha) followed by 185.33 and 148.44 q/ha in GN-15-85 and GN-15-75, respectively. Three top ranking genotypes for average bulb weight were GN-15-78, GN-15-75 and GN-15-85 with 47.20 g, 38.93 g and 36.93g average bulb weight, respectively. While in case of average clove weight, the genotype GN-15-78 exhibited highest clove weight of 4.53 g followed by 3.86g and 3.33g in GN-15-75 and GN-15-85, respectively. The genotype GN-15-52 registered maximum number of cloves per bulb (13.60) followed by GN-15-71(13.46) and GN-15-55 (13.33). Maximum TSS of 41.30⁰Brix was noticed in genotype GN-15-78 followed by GN-1-52 (40.43⁰Brix). The genotype GN-15-85 exhibited minimum weight loss of 2.55 % while as accession GN-15-55 showed maximum bulb weight loss (9.87 %) during two months of storage at room temperature.

The highest yielding genotype i.e. GN-15-78 of AVT-II trial was top ranking genotype among the genotypes evaluated in both the trials, however, the highest yielding genotype of AVT-I trial was stood at second in terms of bulb yield among the genotypes of both the trials. As far as disease and insect pests are concerned, neither any disease nor any insect incidences/attack on any genotype of both the trials was observed during the crop growth and development period.

Assessment of Horticultural Technologies in Kumaon Hills of Uttarkhand for Sustaining Himalayan Ecosystem

Raj Narayan¹, Arun Kishor,² Sovan Debnath², D.B. Singh³, O.C. Sharma,³ Anil Kumar⁴ and S.K. Singh¹

¹ICAR-ATARI, Zone-II, Jodhpur, CAZRI Campus, Jodhpur (Raj.)-342005.

²ICAR-CITH RS, Mukteshwar, Nainital (UK).

³ICAR-CITH, Srinagar (J&K)

ABSTRACT

The programmes, interventions and activities were undertaken at farmers fields in three villages namely Sunkiya, Nainital (UK); Jurkfun, Almora (UK) and Kumahali, Shimla (HP) under National Mission for Sustaining Himalayan Ecosystem (NMSHE) project and implemented different climate resilient technological interventions in the field of horticulture from 2015-16 to 2019-20 by the ICAR-CITH Regional Station, Mukteshwar, Nainital (UK).

In Sunkiya, before the project implementation, the cropping intensity was 200%, farm is un-irrigated/rainfed, depends upon monsoon as well as off season rains, whereas, after project implementation farmers made aware about water use efficiency and they used natural forest waterfalls, naula and prepared low cost rain water harvesting polythene and cemented tanks. Water scarcity is seems to be during summer i.e. in April, May and June. Soil type is sandy, clay, loamy with average pH is 6.88 and EC=0.17ds/m. It is observed from the analyses of soil samples of 14 farmers that soil is acidic in nature, however, pH ranges from 5.94 to 8.41. The organic carbon (%) ranges from 0.25 to 3.94 %, nitrogen (kg/ha) from 141.12 to 223.44, potassium (kg/ha) from 164.85 to 983.01 and phosphorus (kg/ha) from 23.85 to 92.27. But the soil falls in low nitrogen (N) range. After getting soil testing report farmers were aware about the soil nutrient application and recommended dose of crop nutrients as well as importance of organic manures and methodologies of bio-composting/vermin-composting and their use in crop production. Farmers were skilled in soil sampling and testing soil nutrients availability through handy soil kits. Likewise, in Jurkafun village, the farmers are growing agricultural crops (viz., finger millet (Madua), Barnyard millet (Madira), Rice, Black soyabean (Bhatt), Gahat, Raice, Lobia, Amaranthus, Maize, Soyabean, Sarson, Masoor. Vegetable crops, farmers viz., Knol-khol, potato, pea, tomato, capsicum, turmeric, coriander, brinjal, garlic, onion, radish, lady finger, ginger, arbi, palak, karela, pumpkin, bottle gourd and cucumber are been cultivated at household levels. The farmers were also rearing animals (cow, ox, buffalo, goat and hens). Further, in the pilot sites, most of the families are of nuclear type with small and marginal land holdings and in this situation, techniques like high density planting system particularly in temperate fruit crops be proved a best way to enhance yield and quality per unit area and time.

Farmers have sensitized about the improved farm practices to minimize the adverse effects of climate change. Due to various technological interventions implemented in the villages, farmers have started scientific practices of cultivating improved and climate resilient varieties/hybrids in cereals, fruits and vegetable crops. Under the project, vegetable crops namely tomato, capsicum, cucumber, Chinese cabbage, lettuce, broccoli, pea, onion, garlic and potato; fruit crops viz., Apple (cvs. Golden Delicious, Orgon Spur, Skyline Supreme, Chaubattia Princess, CITH Lodh Apple-1, Maayan, Fenny, Tedyman Early, Red Delicious, Red Gold, Chaubattia Anupam, Ambri, Star Krimpson), peach (cvs. Red June and Paradeluxe; plum cvs. Santarosa, Satlej Purple and Kala Amritsari), apricot (cvs. CITH-A-1 & CITH-A-3), Walnut (cvs. CITH-W-1, CITH-W-2), malta, kagzi lime and kiwi fruit (cvs. Allison, Hayward and Tomuri) were introduced in the village(s). Scientific ways of open as well as protected cultivation of vegetable crops, rain water harvesting techniques and its efficient use as irrigation in fruits and vegetables were also demonstrated. Likewise, diverse genotypes of vegetable crops namely Broccoli (KTS-1), Chinese Cabbage (Solan Band Sarson), Lettuce (SolanKirti), Tomato (VL-4, Manisha, H-86, Laxmi, Aman, Shahansha, Dev, Badshah, PS-2225, Navin, Abimanyu), Capsicum (California Wonder, Orobelle, Yamuna, Bomby, Bharat, Lucky Star, Sel-2, Sel-4, Sel-5), Local Cucumber, Brussels Sprout and Garden Pea (VL-10) were planted in farmers fields of selected villages.

Data revealed that tomato hybrid Navin and capsicum hybrid Indam Bharat produced 4.2 Kg and 1.5 Kg fruit yield per plant in low cost polyhouse, respectively whereas, 4.00 Kg tomato fruits per plant were harvested from tomato cv. VL-4 in open field conditions in Jurkafun village. Similarly, Among the 11 tomato genotypes were grown in naturally ventilated polyhouse in Sunkiya village and among them cv. VL-4 was found best in terms of maximum fruit length (5.43 cm), fruit breadth (5.27 cm), number of fruits/plant (51.67), average fruit weight (85.34g) and fruit yield/plant (4.42 kg/plant). During the year 2019-20, demonstrated tomato cv. CITH-M-T-5 and T-3150; cabbage hybrids Varun, Krishna and Green Cornet; broccoli cv. KTS-1, garden pea cv. VL-13 at 14 farmers' fields in Sunkiya village. Similarly, long day onion cv. VL- Piyaz-3 and garlic cv. CITH -M-G-1 Bhima Omkar and Bhima Purple and potato cv. Kufri Grindhari were demonstrated in Sunkiya and Jurkafun villages. The tomato cv. CITH-M-T-5 produced average fruit yield of 3.0 kg/plants and pea cv. VL- 13 registered pod yield of 210.0 gm m² in open field condition at farmers field of Sunkiya village. The Onion cv. VL Piyaz-3 recorded average bulb yield of 4.50 kg m². Likewise, garlic cv. CITH-M-G-1 produced 10.73 kg and 8.10 kg bulbs per one kg. of seed cloves in Sunkiya and Jurkafun village, respectively. Whereas garlic cv. BhimaOmkar and Bhima Purple registered 6.08 kg and 5.94 Kg. bulb yields per one kg. of seed clove in Sunkiya village. However, potato cv. KufriGrindhari registered 12.0 kg. tuber yield from one kg. of seed tuber in Sunkiya village. On the basis of average of plant height of fruit crops viz, plum cv. Santrosa (126.06 cm), apricot cv. CITH-A-3 (231.8 cm) apple cv. Oregon Spur(135.14 Cm), Kiwi fruit cv. Tomuri (193.43cm) malta(254.98 cm) and KagziLime (24.84 cm), in Sunkiya and plum cv. Santrosa (125.55 cm) peach cv. Paradelux (221.1 cm), Apricot cv. CITH-A-

3rd International Conference on “Global Initiative in Agricultural, Forestry and Applied Sciences for Food Security, Environmental Safety and Sustainable Development (GIAFAS-2021)”

1(350.55 cm) , Kiwi fruit cv. Tomuri (105.8 cm), Malta (41.29 Cm) and Kagzi Lime (38.5 cm) in Jurkafun village are found climate resilient fruit crops. Similarly, tomato cv. VL-4 and CITH-M-T-5, Capsicum cv. California Wonder and Bharat, broccoli cv. KTS-1, onion cv. VL Piyaz- 3 garlic cv. CITH-M-G-1, and potato cv. Kufri Giridhari found suitable for growing in the region under changing climatic condition.

Tomato variety VL-4 was yielded more under protected conditions as well as in open field conditions in Sunkiya and Jurkafun village followed by Manisha hybrid. The protected cultivation is observed a suitable climate resilient technology in the region and tomato cv. VL-4 is found a climate resilient variety in open field conditions in Sunkiya and Jurkafun village which is giving good yield when cultivating timely and before monsoon. Crop diversification and Integrated Farming System models established in Sunkiya and Jurkafun villages which are been adopted by the farmers to sustain their farming.

It is also observed that cultivation of long day onion and garlic as well as French bean, garden pea and radish crops in open field conditions and tomato, cherry tomato, capsicum, cucumber, broccoli, Chinese cabbage, lettuce crops under polyhouse are the suitable and sustainable vegetable crops for round the year vegetable production in open and protected conditions under changing climate of the region.

More so, the protected cultivation with vegetables and flowers ensure round the year supply of horticulture commodities in the market especially vegetables and flower. Simultaneously the fruit crops viz., walnut, kiwi fruit, malta, lime, strawberry have the potential in the area and will sustain in changing climatic conditions. Apart from it, the cherry, minor nut fruits, and traditional fruits and vegetables like ramkarela, etc. will be sustained in the region under changing climatic conditions. More importantly, Crop diversification and Integrated Farming System are the best and sustainable options under changing climatic scenario worldwide.

Antifungal activity of some aqueous plant extracts on Leaf blight of Taro caused by *Phytophthora colocasiae*

Sukanya Gogoi*, Popy Bora and Mallikarjun Channappa Chitti

Department of Plant Pathology, Assam Agricultural University, Jorhat-785013, Assam, India

ABSTRACT

The present study was carried out to evaluate the antifungal activity of aqueous extracts of eight different plant species (*Allamanda cathartica*, *Azadirachta indica*, *Chromolaena odorata*, *Eucalyptus globules*, *Lantana camara*, *Lauris nobilis*, *Mikania micrantha*, *Zingiber officinale*) against Leaf blight of Taro caused by *Phytophthora colocasiae* using poisoned food technique at 20% concentration. Out of the entire plant extracts tested, *A. cathartica* showed highest inhibition of mycelial growth of the pathogen, *P. colocasiae*, while, *M. micrantha* showed comparatively low to that of other extracts.

Keywords: Plant Extracts, Leaf blight, *Phytophthora colocasiae*, poisoned food technique.

Bioremediation and Water Pollution – A review

***Prajna Samal, Bireswar Sinha, Soumen Pati**

Department Of Plant Pathology, College of Agriculture, CAU, Imphal – 795004, India

ABSTRACT

The valuable gifts given by nature to mankind for their survival on Earth is – soil, air and water. Among them water is an important component as it forms the basic medium for origin of life. Studies conducted on chemical composition of polluted water reported that the quality of water has been deteriorating day by day. In India, water pollution has reached a critical point and as estimated by the scientists nearly 70% of water has been polluted which causes eutrophication, contamination of the food chain, lack of potable water and diseases. Water pollution can be divided into three main categories, that is, contamination by organic compounds, inorganic compounds (e.g., heavy metals), and surface run off from agricultural lands. So, it becomes our liability to check assemblage of higher dose of any compound in the ecosystem. The number of research studies regarding the use of effective procedures to clean up and minimize the pollution of water bodies has been increasing. In this context, the use of bioremediation for the removal of toxic elements from water is gaining considerable attention. Bioremediation is a microbiological well organized procedural activity which is useful in breaking down or transforming contaminants to less toxic or non-toxic elemental and compound forms. The principle of bioremediation is biodegradation. Multiple mechanisms and pathways have been demonstrated for the biodegradation of a wide variety compounds and it can be completed in the presence and absence oxygen. A wide range of microorganisms, including bacteria, fungi, yeasts, and algae can be used as bio remediators.

3rd International Conference on “Global Initiative in Agricultural, Forestry and Applied Sciences for Food Security, Environmental Safety and Sustainable Development (GIAFAS-2021)”

Bacillus, *Aspergillus*, *Penicillium*, *Pseudomonas* were effectively used for bioremediation. Microorganisms shows great possibility for growth in future as they are congenial to the environment and are cost-effective. Thus, it is demand of the time to move towards sustainable development.

Keywords: Water pollution, Bioremediation, Microorganisms

Evaluation of Different Pruning Intensities in Plum (*Prunus domestica*) at Dehradun Valley of Uttarakhand

Ashish Paul¹*, Dr Suneeta Singh² and Dr Anil Kumar Saxena³

Department of Horticulture, Department of Soil Science, School of Agricultural Sciences, SGRR University, Dehradun-248 001, Uttarakhand, INDIA

ABSTRACT

Present experiment was designed and conducted during the year 2020-21 at Temperate Orchard of Horticulture Research Block, Department of Horticulture, School of Agricultural Sciences, Shri Guru Ram Rai University, Dehradun, Uttarakhand, India to scrutinize the "Effect of different pruning intensities in Plum (*Prunus domestica*) at Dehradun valley of Uttarakhand". The research was laid out in randomized block design with three replications and five treatments. The treatments comprised Control i.e. No Pruning, (0% pruning intensity), 1/4 heading back and thinning out (35% pruning intensity), 1/2 heading back and thinning out (50% pruning intensity), 3/4 heading back and thinning out (75% pruning intensity) and No heading back only thinning out i.e. (100% pruning intensity). The experiment was conducted on well-established six year old plants of low chilling plum cultivar 'Titron'. The observations on various growth and yield attributes were recorded at regular interval. The end result revealed that treatment T4 (100% pruning intensity) found to be the most effective treatment found to be beneficial for vegetative characters viz, plant height (cm), Number of leaves, Length of leaves (cm), Width of leaves (cm) and stem girth (cm). However, on account of economic yield point of view the treatment T3 (75% pruning intensity) found to be most profitable as compared to rest of treatments.

Keywords: *Prunus domestica*, pruning intensity, cultivar, heading back, thinning out

Role of Non-Timber Forest Products (NTFPs) Supporting Healthcare and livelihood in Gurez Valley of Northwestern Himalayas

Ummar Atta^{*}, M.A Islam, S.A Gangoo, Amerjeet Singh and F.A Shah Khan

Faculty of Forestry, Sher-e-Kashmir University of Agricultural Sciences and Technology of Kashmir, Benthama, Ganderbal-191201, J&K, India

ABSTRACT

Non-timber forest products (NTFPs) not only acts as an important source of herbal medicines for forest dwellers but also for pharmaceutical industries and on the other hand, it supports the living of the traditional communities dwelling in and around the forests by providing income to them. Keeping the above facts in view this study seeks to document the diversity, distribution, pattern of utilization of medicinal NTFPs among the households in the Gurez Valley of Kashmir. A multi-stage random sampling technique was employed to select the villages (10) and the households (103). Primary data collected were based on the personal interviews taken from the household heads by using the well-structured pre-tested interview schedules and quasi-participant observations. The results from the study revealed that the sample populace derives medicinal purpose from 56 NTFPs belonging to 40 genera and 31 families. The family Asteraceae had the highest representation (09) of medicinal NTFPs. Of the total edible NTFPs, roots represent the highest (20) while as, basidiocarp, bulb, resin represent the lowest (01). Out of the 56 medicinal NTFPs collected by the rural people, maximum (82.14%), were derivatives of herbs followed by shrubs (7.14%), tree (5.35%), climber (3.57%), and fungi (1.78%). So far as therapeutic properties of different ailments are concerned maximum (9) of the medicinal NTFPs were used as an antitussive, astringent, febrifuge. The medicinal NTFPs accrued an income of ₹756400 annum⁻¹ and employment of 655.20 man-days annum⁻¹. Hence, medicinal NTFPs are being used traditionally to improve healthcare, a local regulatory system should be launched to check over-exploitation and premature harvesting so that they can be extracted on a sustainable basis.

Key words: Medicinal NTFPs, sustainable, Gurez, Kashmir.

Weather Yield Forecast Models of Mustard for Different Districts of Western Uttar Pradesh. Snehdeep¹, Yogesh Kumar¹, S.P. Singh¹, R.K. Naresh², Ashok Kumar¹, K.K. Singh³.

¹Department of Soil Science and agriculture chemistry Sardar Vallabhbhai Patel University of Agriculture & technology Modipuram(UP)-250110

²Department of Agronomy Sardar Vallabhbhai Patel University of Agriculture & technology Modipuram(UP)-250110

³India Meteorological Department, Ministry of Earth Sciences, Mausam Bhawan, New Delhi.

ABSTRACT

Twenty two years (1999-2020) of weather variables and yield data of mustard for different districts of western Uttar Pradesh were used to develop yield forecast model. In statistical method for yield forecasting, actual weekly weather data has been used for development the yield forecast model. The required weather variables for this method are maximum and minimum temperature (°C), rainfall (mm) and maximum and minimum relative humidity (%). Regression equations were generated through statistical method using SPSS package. One regression equation is developed for each district. In this way mustard yield forecasting was completed for the districts under AMFU, SVPUA&T Modipuram Meerut, for year 2020-2021 using statistical method. Highest yield has been predicted for Moradabad district which is 1342 kg/ha while lowest yield has been predicted for Muzaffarnagar district (1123 kg/ha) by statistical method. The models were validated with 2018 and 2019 data set. The results revealed that pre harvest forecasting model had R₂ values ranging between 68 to 84 per cent for mustard in the different districts. During both the years of validation the observed yields were in good agreement with forecasted yields for rice.

***In vitro* callus induction and cell suspension studies in *Catharanthus roseus* (L.) G. Don Pallavi Sati*, Vaishali Chandola*, Monali Chauhan, Sonam Rawat, A R Nautiyal**

High Altitude Plant Physiology Research Centre Hemwati Nandan Bahuguna Garhwal University Srinagar Garhwal Pauri Uttarakhand.

ABSTRACT

The present study investigated the effect of various concentrations and combinations of plant growth regulators on callus induction, shoot proliferation and cell suspension culture in *Catharanthus roseus* (L.) G. Don. To determine the tissue culture potential of *Catharanthus roseus*, the leaf and shoot explants were used. The explants were cultured in Murashige and Skoog medium supplemented with different concentrations and combinations of plant growth regulators. During the study period of five months the leaf explants produced callus and shoot. Maximum callus induction response (100%) was obtained in medium supplemented with [6-Benzylaminopurine (1mg/l) + Indole-3-Acetic Acid (0.5mg/l)] and [6-Benzylaminopurine (1mg/l) + Indole-3-Acetic Acid (2mg/l)] under light and dark conditions whereas minimum callus induction response (50%) was observed in the medium supplemented with Kinetin 2mg/l + Indole butyric acid 1mg/l under light and dark conditions. Indole-3-Acetic Acid and 6-Benzylaminopurine were observed to be more effective for callus formation as 75% response was recorded in 6-Benzylaminopurine (0.25mg/l) and combination of 6-Benzylaminopurine (0.25mg/l) + Indole butyric acid (0.125mg/l). The suspension culture was successful in the species.

Keywords: Callus, Cell suspension culture, Plant growth regulators

Effect of Pruning Intensity in Apple (*Malus domestica*) Under Lower Hills of Uttarakhand

Zahid Rehman^{1*}, Dr Suneeta Singh² and Dr Anil Kumar Saxena³

Department of Horticulture, Department of Soil Science, School of Agricultural Sciences, SGRR University, Dehradun-248 001, Uttarakhand, INDIA

ABSTRACT

The present investigation was planned and conducted during 2020-21 at Temperate Orchard of Horticulture Research block, School of Agriculture Sciences, SGRR University, Dehradun, Uttarakhand, India to investigate "Effect of different pruning intensities in Apple (*Malus domestica*) under lower hills of Uttarakhand". The experiment was laid out in randomized block design with three replications and five treatments. The treatments comprised Control i.e. No Pruning, (0% pruning intensity), 1/4 heading back and thinning out (30% pruning intensity), 1/2 heading back and thinning out (50% pruning intensity), 3/4 heading back and thinning out (70% pruning intensity) and No heading back only thinning out, (100% pruning intensity). The experiment was conducted on well-established six year old plants of apple cultivar 'Tropical Beauty'. Observations on various growth and yield attributes were recorded. The result revealed that treatment T4 (100% pruning intensity) found to be the most effective treatment found to be beneficial for vegetative

3rd International Conference on “Global Initiative in Agricultural, Forestry and Applied Sciences for Food Security, Environmental Safety and Sustainable Development (GIAFAS-2021)”

characters viz, plant height (cm), Number of leaves, Length of leaves (cm), Width of leaves (cm), stem girth (cm) and yield attributes. From economic yield point of view treatment T3 (70% pruning intensity) found to be profitable as compared to rest of treatments.

Keywords: Pruning intensity, heading back, thinning out, apple, plant height

Biogenic Synthesis of Potassium Nanoparticles for Evaluation as Nanofertilizer in Wheat **Sapna Grewal *¹, Promila Sheoran¹, Santosh Kumari ¹, Sonia Goel ²**

Department of Bio & NanoTechnology, Guru Jambheshwar University of Science & Technology, Hisar, Haryana, India-125001

Faculty of Agricultural sciences, SGT University, Gurugram, Haryana, India-

ABSTRACT

Plants require many nutrients for optimum growth and potassium is one such nutrient that has a important role in growth & development of any plant. It is known to regulate metabolism and various physiological functions of plants. Its importance has been realized long ago and as a result its utilization in crop production has increased by several times. We hereby report the first ever biogenic synthesis of potassium nanoparticles using *Morus alba* plant leaf extract and its promising ability to promote growth in wheat. The synthesized nano particles were characterized in detail for their morphological and stability related parameters. The average particle size of biosynthesized potassium nanoparticles analyzed by DLS was 89.32 nm and Polydispersity index (PDI) was 0.518 indicating high level of mono-dispersity of the particles. The size of the nanoparticles ranged about 21-30 nm as per TEM measurement. Zeta potential of K NPs was found to be -36.4 mV indicating good dispersion stability. Three different concentrations of nano-potassium (20, 40, 60 PPM) were tested along with a control (with no external added potassium supplement) and chemical counterpart (Potassium Sulphate) under field conditions. Nano-potassium application resulted in an overall increase in spikelets per spike, number of spikes, yield, total protein content & photosynthetic pigments of wheat. The activity of phosphate mobilizing enzymes like acid and alkaline phosphatase was also recorded which was found to be increased on application of nano-potassium indicating its better use efficiency by the plant.

Development and Evaluation of Self-propelled Potato Digger

Neeraj Singh Parihar¹, Sushil Sharma¹, Sanjay Khar¹ and J.P. Singh¹

Division of Agricultural Engineering, Sher-e-Kashmir University of Agricultural Sciences & Technology of Jammu (Chatha campus, 180009)

ABSTRACT

A study was carried out to develop and evaluate a self-propelled potato digger for small land holding farmers of hilly areas of Jammu. The self-propelled potato digger having a power transmission unit, digging unit and separating/collecting unit was developed to suit the local conditions. These units were attached onto a main frame using nut bolts and welding while the whole system derived its power from a diesel engine (6.71 kW or 9 hp). The developed prototype was evaluated on *Kufri Jyoti* variety of potato during *Kharif*, 2021. The performance of the developed prototype was studied at three forward speeds (2, 2.5 and 3 kmh⁻¹), three vibrating frequencies (900, 1200 and 1500 rpm) and three different rake angles (20, 23 and 26°). The performance was evaluated on the basis of digging efficiency (%), digging depth (mm), separating index (%), damage percentage (%), fuel consumption (lh⁻¹), required power (kW), field capacity (hah⁻¹) and field efficiency (%). The performance of the prototype was found to be satisfactory under the identified conditions.

Agroforestry: A Suitable option to increase farmer's income in Jabalpur region of Madhya Pradesh

Parul Sharga, Dr.S.D Upadhyaya, Dr.D.V.Bhagat

Tropical Forest Research Institute, Jabalpur, M.P.

Dean, Medicaps University, Indore, M.P.

DARP, College of Agriculture, Indore, M.P.

ABSTRACT

The tree species *Gmelina arborea* in current scenario is in great demand for multiproduct uses particularly for its timber quality. An experimental trial on *Gmelina arborea* based agroforestry system was carried out to study tree crop interaction. The study comprised of different tree-crop combinations. Arable crops selected were pigeon pea, cowpea,

3rd International Conference on “Global Initiative in Agricultural, Forestry and Applied Sciences for Food Security, Environmental Safety and Sustainable Development (GIAFAS-2021)”

greengram, mustard. Various parameters were evaluated in order to evaluate the resource utilization as well as distribution among the components of the agroforestry system. The experimental trial of Gmelina was two and half years old. So, it was observed that in the early growth stages of tree species there occurred minimal competition at tree-crop interface. It was found that growth resources quantification particularly for light, productivity under agroforestry system did not suffered negative interactions. While, soil moisture content was quite affected leading to competitive phase. The light interception studies revealed that the tree canopy does not caused obstruction in growth of arable crop taken under experimental study. The nutrient contents in the soil under the agroforestry system got enhanced. So, it is recommended from the present study to all the stake holders involved in practices of agroforestry that maximum benefits can be withdrawn from the crop system at initial growth stages of tree species and after reaching the exploitable diameter, profits are withdrawn from woody perennials. Hence, the practice of agroforestry system is a long term project analysis giving rise to better utilization of land constraint and maximum resource sharing.

Keywords: *Gmelina* arborea, Agroforestry system, Tree crop interaction, Soil Moisture

Artificial diet for laboratory rearing of *Acanthoporous serraticornis* (Olivier) *Prosopis cineraria* (L.) Druce (Khejri) root borer

Shiwani Bhatnagar*, Sangeeta Singh, Ameen Ullah Khan, Bundesh Kumar, Parveen Goran, Vineeta Srivastav, Bindu Nirwan and Lokendra Singh Rathore

Forest Protection Division Arid Forest Research Institute, Jodhpur (Rajasthan)

ABSTRACT

Prosopis cineraria (family: Leguminosae; subfamily Mimosoideae), also referred as the '*king tree*' of Indian desert, is revered for its range of products and services rendered to desert inhabitants. It provides fodder, fuel, food, timber, and shade. Khejri is endemic to the hot deserts of India and is considered to be an essential component of agroforestry land use system with enormous economic and cultural values to the people of Rajasthan. It is also important as it effectively stabilize sand dunes and can withstand periodic burial. But the population of Khejri, a priority tree and life line of Arid ecosystem, is rapidly declining due biotic factors (root rot fungus *Ganoderma lucidum* and root borer, *Acanthoporous serraticornis*). Cerambycid beetles, *Acanthoporous serraticornis* (family: Cerambycidae) are among the largest beetles of India. It is responsible to cause severe root tunneling in khejri trees. They attack living trees as well as freshly felled timber. This large indigenous beetle has become an active and serious pest of khejri trees in arid and semi-arid region of north-western India. The larvae bore into the wood and in severe cases can eventually kill the tree, particularly if it is old and lack vigour. The full grown larvae of these insects are large and destructive whose feeding essentially destroys the tree's root system over time. Adults are also known as longhorn beetles with long antennae having 12 segments with the fifth to the eleventh having a spiny outgrowth at the tip. As it is a root borer therefore it's tough to record different life stages of insect in field condition. Considering the lack of information on rearing techniques for this insect, the objective of this study was to develop an artificial diet to rear *Acanthoporous serraticornis*. To attain this objective, first, three artificial diets were tested. Only the diet based on Jowar was able to supply the nutritional requirements of the insect and support completion of its life cycle. After standardizing artificial diet based on Jowar, rearing of *Acanthoporous serraticornis* larvae in laboratory was done to study the life cycle of the insect. According to larval development, weight showed a rapid increase during the months before pupation. The morphometric measurement and weight of different larval instars were recorded. The increase in larval weight was very quick till the 19th instars and thereafter weight reduced before going for pupation. Average weight of 19th instar larvae was found to be 38.47g with cephalic measurement 2.98 ± 0.013 . In adult body length was observed to be 10.2 ± 0.26 (male) and 5.4 ± 0.15 (female). The life cycle of *A. serraticornis* about three and a half years to complete.

Keywords: *Prosopis cineraria*, *Acanthoporous serraticornis*

Marwar teak defoliator *Patialus tecomella* (coleoptera: curculionidae) infestation on *Tecomella undulata* (Sm.) Seem. (Rohida) in Rajasthan

Shiwani Bhatnagar*, Neha Sharma, Raj kumar Suman, Mamta Sankhla, Ameen Ullah Khan, Sangeeta Singh and Tanmay Boi

Forest Protection Division Arid Forest Research Institute, Jodhpur (Rajasthan)

ABSTRACT

Tecomella undulata (family Bignoniaceae) locally known as Rohida is a key species of Thar Desert (Rajasthan). It is a deciduous or nearly evergreen tree of arid and semi arid regions. As it has drought and fire resistant and higher survival rates it is valuable for afforestation, agroforestry, phytoremediation and amelioration purpose. It grows commonly in

community land and forestland along with *Prosopis cineraria*. It is known to produce quality timber that makes this tree species economically very important. Its wood is valued equal to Teak and for that reason it is also called as ‘Marwar Teak’ of Rajasthan. It has ample therapeutic activities like, antibacterial, antihepatotoxicity, immunomodulatory, anti-inflammatory activities etc. Currently, the plant is under endangered category due to overexploitation, indiscriminate felling for timber and fuel, insect-pest infestation, poor regeneration, slow growth, loss of habitat due to urbanization and lack of interest in its cultivation. All of these reasons have severely depleted the natural population of this valuable tree. Therefore conservation and management of this tree species is very important to maintain this important natural asset of Rajasthan. Though about 64 insect species has been reported feeding on *Tecomella undulata* but a heavy infestation of defoliator *Patialus tecomella* (coleoptera: curculionidae) an ootheca laying weevil is recorded on *Tecomella undulata* causing damage to both nursery plants and tree stands. Its larvae are rapacious feeder on leaves and cause severe skeletonization of leaves. Adults cut the leaves from the margin in uneven pattern and feed on the green matter making irregular holes. Heavy infestation by *Patialus tecomella* is reported in the month of September–October. Larvae feed on the leaf surface, passes from three instars and pupate in the soil. Adults hibernated from December to February. The insect passes through 5-6 overlapping generations in a year. *P. tecomella* takes 33-35 days to complete its life cycle.

Keywords: *Tecomella undulata*, *Patialus tecomella*

Bioremediation of soil persistent pesticides by microbes: A novel approach for pesticide waste management

Shiwani Bhatnagar¹ and Desha meena²

¹Forest Protection Division, Genetics and Tree Improvement Division, Arid Forest Research Institute, Jodhpur, Rajasthan

ABSTRACT

Pesticides are a group of substances premeditated to kill pests including weeds, insects, and rodents. But, the extensive use of pesticides may result into their accumulation in the soil due to their low biodegradability. The regular monitoring and management of pesticide usage holds importance on account of the risks posed by pesticides on living beings and on the environment. Continuous application of synthetic pesticides has detrimental effects on soil micro biota and may result in loss of biodiversity and extinction of useful organisms present in the soil. Besides polluting the soil, pesticide residues also influence presence of useful organisms like earth worms, bees, spiders and natural enemies of insect pest which otherwise would have contributed towards preventing harmful pests. Bioremediation can here play an important role as by using naturally occurring bacteria, fungi, algae, plants etc., under controlled conditions it biologically degrades organic wastes to a harmless state which is non toxic and non hazardous to human health and ecosystem. For the success of bioremediation, choice of right microbes (bacteria and fungi) with capabilities to degrade the pollutants and desirable environmental factors for degradation to occur is very important. Some microbes viz., *Pseudomonas*, *Bacillus*, *Azotobacter*, *Flavobacterium* and fungi such as *Trichoderma*, *Auricularia*, *Pleurotus*, *Stereum* etc have the ability to degrade pesticides like organophosphorus, chlorinated compounds, triazine, phenyl urea, dicarboximide etc., into non toxic compounds by commencing slight structural changes to the pesticides. So in the world with high demand of food, low availability of land for agriculture and injudicious use of chemicals our research should orient towards development of bioremediation strategy with the use of these microbes for degrading persistent toxic chemicals in soil for a sustainable environment.

Keywords: pesticides, bioremediation, microbes

Therapeutic Potential and Antioxidant Activity of *Piper Betle L.*

Renuka Jandu¹ and Dr. Varsha Rani²

Department of Foods and Nutrition, CCS Haryana Agricultural University, Hisar, Haryana, India

ABSTRACT

The deep green heart shaped betel leaves popularly called as *paan* in India, belongs to *Piperaceae* family and known for its nutritional and medicinal value. The betel leaves have been described as aromatic, sharp, hot, acrid and beneficial for voice, laxative, appetizer, beside this, they pacify *vata* and aggravate *pitta*. In *Ayurveda*, betel leaves extract was frequently used as an adjuvant and mixed with different medicines. Leaves are rich in many nutrients like water, energy, protein, fats, fiber, calcium and iron etc. and the antioxidants present are flavonoids, tannins, saponins alkaloids,

3rd International Conference on “Global Initiative in Agricultural, Forestry and Applied Sciences for Food Security, Environmental Safety and Sustainable Development (GIAFAS-2021)”

terpenoids etc. Piper betel possess various pharmacological properties include anticancer, antimutagenic, anti-amoebic, anti-giardial, anti-inflammatory, mosquito larvicidal, antimicrobial, immunomodulatory, antiulcerogenic, radioprotective, antileishmanial, and antifungal activity. Piper betel leaf is also useful for the treatment of various diseases like bad breath, boils and abscesses, conjunctivitis, constipation, headache, hysteria, itches, mastitis, mastoiditis, leucorrhoea, otorrhoea, ringworm, swelling of gum, rheumatism, abrasion, cuts and injuries as folk medicine while the root is known for its female contraceptive effects. Most of the therapeutic activities of betel leaves are due to presence of antioxidants. Total phenolic contents reported in fresh betel leaves 683.49 mg GAE/100g. piper betel is rich source of other antioxidants such as total flavonoid content, Ferric reducing activity property and DPPH radical scavenging activity. Betel leaves also possess anti-inflammatory compounds, which tremendously diminish discomfort and aching in the joints, also chronic illnesses like rheumatoid arthritis, osteoporosis etc. Antioxidant activities help in improving heart health, diabetics and also have anticancer potential. This could be attributed to its ability to scavenge free radicals involved in initiation and propagation steps. Betel leaves are highly nutritive and contain considerable amount of **vitamins and minerals, especially calcium, iron, potassium and β -carotene**. The nutritionally rich recipes prepared from incorporation of betel leaves, by using betel leaves in our day to day life reduce the risk of many diseases. Many products were developed by incorporation of betel leaves such as *ladoo*, cutlets and bakery products. It has great potential to be incorporated in development of value added products.

Investigation of phytochemicals and antimicrobial activity of Tulsi (*Ocimum sanctum* L.)

Ankit Agrawal and Pankaj Chauhan

Department of Cell Biology, Sardar Vallabhbhai Patel University of Agriculture and Technology, Meerut

ABSTRACT

In recent years researchers have been paid attention to find out new alternative sources of antimicrobial agents especially from plant sources. *Ocimum sanctum* (tulsi) is an aromatic medicinal plant in the family Lamiaceae. The main chemical components of tulsi are: Oleanolic acid, Ursolic acid, Rosmarinic acid, eugenol, Carvacrol, Linalool have been used extensively for many years in food products, perfumery, and dental and oral products. Phytochemical screening of the plant leaf reveals that the presence of saponins, alkaloids, flavonoids, steroids, phenols, tannins and glycosides. Different leaf extracts of *Ocimum sanctum* leaves were prepared and its antimicrobial activity were evaluated by agar well diffusion method against both Bacterial species such as: *Bacillus cereus*, *Pseudomonas aeruginosa*, *Bacillus subtilis*, *Staphylococcus epidermidis*, *Escherichia coli* as well as Fungi pathogens such as: *Aspergillus fumigatus*, *Candida albicans*, *Penicillium Chrysogenum*. The antimicrobial activity of crude methanolic, ethanolic, acetone and aqueous extract of *O. sanctum* was evaluated to find the zone of inhibition, so that antimicrobial activity of various extract of leaves of *Ocimum sanctum* was carried in attempt to develop a new pharmaceutical drug from natural origin for prevention of pathogenic microbes.

Key words: *Ocimum sanctum*, Tulsi, Phytochemicals, Zone of Inhibition, Extract, Microbes

Compilation of Chilli Indigenous knowledge Practices in Sikkim State

Smriti Subba, Anindita Saha, & Ravi Kumar Gupta,

Department of Agricultural Extension, Palli Siksha Bhavana (Institute of Agriculture), Visva-Bharati (A Central University), Sriniketan, West Bengal, India Pin Code - 731236

ABSTRACT

The chilli ‘dalle khorsani’ is widely known as cherry pepper in the north eastern parts of India. Chilli is one of the most valuable crops in Sikkim. Red round chilli is known as Dale khorsani in Sikkim and its scientific name is *Capsicum annum* and belongs to the family solanaceae. The study was conducted in the East District of Sikkim, selected purposively for the study. A total of 120 respondents were selected for the study. A well structured pre-tested interview schedule was prepared for the study. For this studies used many variables viz. age, education, family size, annual income, farming experience, farm size, social participation, mass media exposure and two dependent variables viz. documentation of indigenous practices, degree of belief of indigenous practice. Statistical tools like frequency, percentage, arithmetic mean and standard deviation were used for the study. Chilli growers belong to the ‘farmers category and farmers share individual indigenous ideas and knowledge with each other and are concerned with old aged farmers who enrich in ingenious knowledge. The study concluded that farmers have been using their indigenous knowledge since time immemorial, implying in case of planting season, growing pattern, growing methods, and processing herbs and against disease control.

Keywords: Agriculture, Chilli Cultivation, Farming Experience Indigenous Practice Planting, Traditional Knowledge.

Effect of Salt stress on Biomass, Biochemical Parameters & Yield of Soyabean (“ Glycine max.(L.)Merril”)

Gulafshan & Farha Rehman

Department of Botany, Mohammad Ali Jauhar University, Rampur (U.P.) India

ABSTRACT

Soyabean is an important oil yielding plant & world wide distributed. Here our experiment was conducted to determine the effect of different concentration (0, 50mM, 100mM & 200mM) of Sodium Chloride on Biomass, Chlorophyll pigment, Carotenoid, Proline & Yield. The finding revealed that plant length, Plant fresh & dry weight, leaf number, leaf area /plant, chlorophyll pigments & carotenoid were significantly reduced in high dose (100mM & 200mM) of Sodium Chloride as compared to control. But there is no remarkable negative effect of sodium chloride on plant biomass & yield, when treated with low concentration (50mM) of salt. This work understanding how a plant responds at different salinity level i.e. (50, 100 & 200mM). Salt stress increased the level of proline content. This work may be helpful to know saline soil induced metabolic disturbances in plants, effecting plant growth development & quality of yield in plants of Soyabean. Salinity causes an osmotic inhibition, which effect the biochemical function of the plant cells.

Diversity and Functionality of Seed Vected Bacterial Endophytes in *Triticum aestivum* L. across Boundaries of Cultivars and Ecology

Jogdande Sai Prasad, Archana Suman

Division of Microbiology, ICAR-Indian Agricultural Research institute, New Delhi

ABSTRACT

The present work demonstrates wheat seed endophytic bacterial (WSEB) taxonomic structure, potential PGP functions, colonization in the plant growth. Isolated and purified total 220 bacterial isolates based on multifarious PGP activities; genotypic characterization of 62 isolates using 16SrRNA gene, revealed 7 different genera with 20 distinct species falling into 3 phylum Firmicutes (85.48%), Proteobacteria (9.67%) & Actinobacteria (4.83%), with predominant genera *Bacillus* in Firmicutes. The 16SrRNA gene sequences of 62 isolates submitted to NCBI GenBank (Accession Nos; MT184815-MT184873, MT672532- MT672534).

Quantification of PGP activities *P. putida*-NWP-10, *P. agglomerans*-NH-4, *B. cereus*-NWP-5 isolates exhibited maximum N₂ fixation, P-solubilization and IAA respectively. In antagonism assay, 33/62 isolates showed >65% inhibition to 3 pathogens. Live cells staining using TTC, DAB-H₂O₂ and biomarker tagging of *gfp* vector pCambia-1302 tracked in different plant parts. Based on two pot and field experiments with 3 wheat species and 4 levels of fertilizer inputs concluded finally *P. agglomerans*-NWPZ-9, *P. putida*-NWP-10, *B. megaterium*-NEP-22 are adjudged as the best seed endophytes.

Keywords: WSEBs, identification, staining, GFP tagging and tracking, Pot & Field experiments

Bio-chemical Studies of Kalmegh (*Andrographis paniculata* Burn F. Ex) with Particular Reference to Impact of Growth Hormones

D.K. Raidas

RAK College Sehore (M.P.)

ABSTRACT

Andrographis paniculata, commonly known as Kalmegh, is used both in Ayurvedic and Unani system of medicines because of its immunological, antibacterial and hepatoprotective properties. The investigations were carried out at the farmer field, Village Badiyakhedi, District Sehore, (M.P.) during *Kharif* 2015-16 & 2016-17. There were nine treatments Cycocel (100, 150 and 200ppm), GA₃ (100, 150 and 200ppm) and NAA (100 and 150ppm) and water spray as control. This study was done on the base of randomized complete block design. All the treatments were replicated three times in randomized block design. Investigations under taken aiming to increase the morphological, physiological, yield parameters, interactive effect of growth & edaphic factors, and biochemical parameters. The plant height (cm) plant⁻¹, weight of fresh leaves (g) plant⁻¹, dry weight of leaves (g) plant⁻¹, leaf area cm² plant⁻¹, and chlorophyll index (SPAD) of Kalmegh, especially sprayed with GA₃ @100ppm were more effective than other plant

growth hormones at different stages of crop. The number of branches plant⁻¹ of Kalmegh was more effective by application of Cycocel@100ppm than other treatments at different stages of crop. The photosynthesis rate ($\mu\text{mol CO}_2 \text{ m}^{-2} \text{ s}^{-1}$), stomatal conductance ($\text{mmol H}_2\text{O m}^{-2} \text{ s}^{-1}$), transpiration rate ($\text{mmol H}_2\text{O m}^{-2} \text{ s}^{-1}$), CO_2 utilization (ppm) and H_2O utilization (Kpa) at different stages of crop. interactive effect of growth & edaphic factors viz. soil moisture (%), disease incidence (%), yield and yield attribute viz., seed yield ($619.78 \text{ Kg ha}^{-1}$), and dry herbage yield (45.74 qha^{-1}) were found significantly higher with foliar sprayed with GA_3 @100ppm as compared to Cycocel @ 100ppm and Cycocel @200ppm respectively. The biochemical parameters viz., andrographolide content (2.57%) and active ingredient content ($103.47 \text{ Kg ha}^{-1}$) of Kalmegh were recorded significantly more with foliar application of GA_3 @100ppm as compared to other treatments in both the years.

Genetic Diversity in Bread Wheat (*Triticum aestivum* L.) for Morpho-physiological Traits and Grain Micronutrient Content

¹Mainak Barman*, ¹Vinay Kumar Choudhary, ¹Satish Kumar Singh

Department of Plant Breeding and Genetics, Dr. Rajendra Prasad Central Agricultural University, Pusa, Samastipur-848125, Bihar, India

ABSTRACT

Wheat is considered one key staple food crop in numerous places of the globe. Malnutrition of micronutrients, largely the deficiency of Zinc and Iron, worldwide distresses over three billion people. Keeping these considerations insight, the current evaluation of genetic diversity in bread wheat was performed taking 30 genotypes in DRPCA, Pusa, Samastipur, Bihar, India during the *Rabi* season of 2019-20 adopting RBD with three replications. The study was executed on genetic variability, genetic advances, correlation coefficients, path coefficients, and genotype diversity. Observations were documented for thirteen morpho-physiological characters alongwith grain Fe and grain Zn content. ANOVA revealed significant differences among all the evaluated genotypes for all the studied parameters. Heritability along with genetic advance estimates indicated that the characters, namely, grain Zn content, grain Fe content, flag leaf area, no. of tillers/ plant and the number of grains/ ear, demonstrated high heritability and high genetic advance as percent of the mean. Correlation analysis showed a significant positive relationship of no. of tillers/plant, days to 50 % flowering, flag leaf area, spike length, plant height, chlorophyll content, relative water content, no. of grains/ ear, days to maturity, thousand-grain weight, and harvest index with grain yield per plant. The genotypes were grouped into nine clusters. Genotypes RAUW-18-15, RAUW-18-21, DBW 16, BHU 25, RAUW-16-4 were genetically diverse and had the highest intra-cluster distance. The highest contribution in manifesting genetic divergence was revealed by grain Fe content indicating a rewarding trait to execute selection.

Keywords: Wheat; ANOVA; Heritability; Correlation; Path coefficients; Clusters

A study on seed replacement rate of paddy in Chandauli district of Uttar Pradesh

Mohit Kumar Gupta^{1*}, Kalyan Ghadei² and Gyan Shukla³

¹Department of Extension Education, Dr. Rajendra Prasad Central Agricultural University, Bihar

²Department of Extension Education, Institute of Agricultural Sciences, Banaras Hindu University, Uttar Pradesh

ABSTRACT

Among all resources used in agriculture seed is the basic input of agriculture and least expensive too. As we all know that seed replacement with quality seed can enhance productivity to a certain level. In contrary, from our literature survey the adoption of quality seed and seed replacement is not so popular among the farming communities of India. Hence, we planned to investigate the socio-economic attribute of respondents, their attitude, knowledge and level of adoption along with the constraints faced by farmers in seed replacement. The interview schedule was designed for collecting the relevant information of selected variables. The data were collected personally with the help of a pre-tested interview schedule from farmers. The study comprised 130 farmers selected using proportionate random sampling to know their attitude, knowledge and level of adoption and also the constraints faced by them in seed replacement. The statistical techniques used in the study were Frequency, Percentage, Mean and Standard Deviation. It was found that majority of the farmers were in middle age group, having higher secondary and above education, belonged to Other backward classes with medium family size. It was also revealed that majority of farmers were having medium farming experience, low participation in extension activities, marginal size of land holding, engaged only in Agriculture and having medium annual income. It was analysed in the study that majority of farmers were having low sources of

3rd International Conference on “Global Initiative in Agricultural, Forestry and Applied Sciences for Food Security, Environmental Safety and Sustainable Development (GIAFAS-2021)”

information, purchased less than 25 kg of seed from private seed dealer and determine the seed quality through advice of known person. It was observed that farmers were having moderately favourable attitude, having medium level of knowledge and medium level of adoption towards the seed replacement in paddy crop. The overall seed replacement rate in Chakia block of Chandauli districts was found to be 62.03%.

Keywords: *Certified Seed, Quality Seed, Seed Replacement Rate.*

Physico-chemical composition of different genotypes and varieties of Aonla (*Emblica officinalis* Gaertn.).

Jitendra Chandravanshi, Eeshwar Sahu, Pratibha and D.P. Sharma,

Department of Horticulture (Fruit science), College of Agriculture JNKVV, Jabalpur (M.P.) 482004

ABSTRACT

The present investigation on “Physico chemical study of aonla genotypes (*Emblica officinalis* Gaertn.)” Syn.-*Phyllanthus Emblica*. Aonla is one of the nutritive fruit crops and is well known as richest source of Vitamin-C content. The present experiment was conducted to evaluate the performance of 20 different genotypes and varieties of Aonla for physico-chemical study under Jabalpur (M.P.) condition. The results revealed that, significant variability was observed among the genotypes and varieties for different parameters. The genotype JA 116 recorded maximum pulp per cent (97.13 %), specific gravity (1.93g/ml), acidity (1.66%) and ascorbic acid (566.87 mg/100 g). Maximum fruit weight (53 g) and TSS (9.11°brix) was recorded in JA 114. Maximum moisture per cent (86.39%) was noted in JA 113. Maximum seed weight (2.26 g) was recorded in Chakaiya and maximum fruit volume was observed (34.40 ml) in Francis.

Keywords: Aonla and Physico-chemical.

Characterization of different genotypes of Aonla (*Emblica officinalis* Gaertn) developed in JNKVV Jabalpur (M.P.)

Jitendra Chandravanshi, Brajesh Dhakad, Kanta Sahu and A. K. Singh

Department of Fruit Science, College of Agriculture, Jabalpur (M.P.) 482004

ABSTRACT

The present experiment entitled “Characterization of different varieties of Aonla (*Emblica officinalis* Gaertn) developed in JNKVV Jabalpur (M.P.) ” was conducted during 2019–20 at Fruit Research Station, Imliya, Department of Horticulture, JNKVV, Jabalpur (M.P.). The Maximum fruit yield per plant (133.38kg), pulp percentage (97.13%), acidity (1.66%), ascorbic acid (566.87 mg/100g) and total sugar (5.08%) were recorded JA 116. The maximum fruit volume (34.40ml) with Francis while minimum (17.20ml) were recorded with JA110. The maximum fruit weight (53g), fruit diameter (4.63), fruit length (4.14cm), specific gravity (1.70g), and TSS (9.11 °brix) were recorded with JA 114 while highest stone weight (2.26g) and reducing sugar (3.51%) with chakaiya. The highest moisture percentage (86.49%) with JA 113 while lowest (81.98%), fruit length (2.49cm), and fruit weight (16.93g) were recorded with JA107. The minimum specific gravity (0.87g) and reducing sugar (2.05%) were recorded with treatment JA105 while the minimum non reducing sugar (0.27%) and total sugar (3.38%) were recorded under treatment JA 118. The minimum pulp percentage (93.43%) in JA 109, TSS (5.42 °brix) in JA 118, acidity (0.86%) in JA 112, ascorbic acid (453.12 mg/100g) in JA 103 and stone weight (0.96g) was recorded with JA 116.

Keywords: Aonla, genotypes and Jawahar Aonla (JA).

Physico-chemical study of Aonla genotypes (*Emblica officinalis* Gaertn)

Jitendra Chandravanshi, Eeshwar Sahu, Rohit Singh and D.P. Sharma

Department of Fruit Science, College of Agriculture, Jabalpur (M.P.) 482004

ABSTRACT

The present experiment entitled “physico-chemical study of Aonla genotypes (*Emblica officinalis* Gaertn)” was conducted during 2019–20 at Fruit Research Station, Imliya, Department of Horticulture, JNKVV, Jabalpur (M.P.). The maximum fruit weight (53g), fruit diameter (4.63), fruit length (4.14cm) and TSS (9.11 °brix) were recorded with JA 114. The Maximum pulp percentage (97.13%), acidity (1.66%) and ascorbic acid (566.87 mg/100g) were recorded JA 116 while highest stone weight (2.26g) in chakaiya, pulp: stone ratio (35.16) in JA 177, TSS: acid ratio (11.00) in JA101 and stone diameter (3.08) was recorded with Francis. The minimum pulp: stone ratio (15.36), fruit diameter

3rd International Conference on “Global Initiative in Agricultural, Forestry and Applied Sciences for Food Security, Environmental Safety and Sustainable Development (GIAFAS-2021)”

(3.22cm) and stone diameter (1.85cm) under JA104. The minimum fruit length (2.49cm) and fruit weight (16.93g) were recorded with JA107, pulp percentage (93.43%) in JA 109, TSS (5.42 °brix) in JA 118, acidity (0.86%) in JA 112, ascorbic acid (453.12 mg/100g) in JA 103, stone weight (0.96g) and TSS: acid ratio were recorded with JA 116.

Keywords: Aonla, genotypes and Jawahar Aonla (JA).

Effect of Organic Manure and Corresponding Humic Acid on Nitrogen Transformation and Yield of Chickpea Grown in an Acid Soil

Nongthombam Surbala Devi, Geeta Nongmeikapam, T. Sanahanbi Devi, Nakeertha Venu and L.Nikita Devi

Department of Soil Science and Agricultural Chemistry, College of Agriculture, Central Agricultural University, Iroiseмба, Imphal-795 004, Manipur, India

ABSTRACT

Nitrogen (N) is an important essential plant nutrient required for growth and metabolic activities thereby improving the productivity of crops. It can be applied through inorganic or organic sources. Understanding the effect of organic sources on the transformation of nitrogen into different forms is required for sustainable nitrogen management. A pot experiment was conducted to study the influence of organic nitrogen sources (viz., urea, FYM, compost, vermicompost, N-enriched compost and humic acids extracted from the corresponding organic manures) applied at the rate equivalent to 20 kg N ha⁻¹ on changes in different forms of N and yield of chickpea (JG-16) grown in an acid soil. Result of the investigation revealed that all the treatments involving N application had significantly greater amount of exchangeable NH₄⁺, soluble NO₃⁻, total hydrolysable organic N, non-hydrolysable organic N, total N and pod yield over untreated control. Amount of exchangeable NH₄⁺, soluble NO₃⁻ and pod yield were observed more in soil added with organic manures as compared to the corresponding humic acids. However, comparatively higher accumulation of total hydrolysable organic N, non-hydrolysable organic N and total N were recorded in humic acids amended soils than organic manures. Gradual declining trend of total N and total hydrolysable organic N content till harvest showed the main contribution of hydrolysable organic N towards available N. Organic manures mineralized at faster rate with higher agronomic efficiency comparing with the respective humic acids. Among the organic manures, FYM revealed faster mineralization as well as higher pod yield of chickpea.

Keywords: Organic manure, humic acid, inorganic N, organic N, Yield

“COST EFFECTIVE BIOPROCESS FOR ANTI-VIRAL BIOACTIVE PRODUCTION THROUGH MICROBIAL TRANSFORMATION”

Sugandha Mishra¹ Dharendra Kumar^{2,3*}, Dharmendra Jain⁴ Amit Kumar dutta⁵

¹*Department of Environmental Science, Govt. (PG) College for Women, Rohtak, Haryana,*

²*UIET, Maharshi Dayanand University Rohtak, Rohtak-124001, Haryana*

³*Department of Botany, Chaudhary Bansi Lal University, Bhiwani, Haryana (India)*

⁴*Department of Pharmaceutical Science, Dr Hari Singh Gaur University, Sagar, (MP) India.*

⁵*Amity Institute of Biotechnology, Amity University Jharkhand, Ranchi, India.*

ABSTRACT

Now as days, every day a new disease or ailments are knocking on living beings. Either humans, animals, birds or even other forms are now more prone to get newer infections due to degrading environment. Betulin, betulinic acid and their derivative are naturally occurring lupane-type pentacyclic triterpenes with noteworthy pharmacological application like anti-tumor, anti-HIV and anti-covid activities. AIDS-HIV is a mixture of conditions that gradually reduces the immunity of the host making them more susceptible to even common infections like influenza. The cure of HIV is generally based on a blend of 3 or more type of medication which is named as HAART (Highly active anti Retroviral Therapy). This blending of medication supports in the reduction of chances for virus replication by masking their mutations. Including as anti-HIV, most appropriate corona virus drug targets and matching lead molecules must be identified without delay is need of the hour. To develop various antiviral therapeutics specially against human corona virus (HCoV) infections, recently scientists reported the discovery of a hexameric protein component of the viral replication-transcription complexes, ie class of HCoV inhibitors acting on nsp15. This protein complex is armed with immune evasion-associated endoribonuclease activity. Now Betulin and Betulinic acid (BA) with its derivatives represents as significant group of anti-HIV agents with novel mechanisms. Previously Betulin and Betulinic acid derivatives were chemically synthesized by altering different groups especially at C3, C20 and C28 positions but here our aim is through microbial transformation. Different ranges of betulin were tried and 1.3mg/l was found best for

3rd International Conference on “Global Initiative in Agricultural, Forestry and Applied Sciences for Food Security, Environmental Safety and Sustainable Development (GIAFAS-2021)”

maximum growth at 250 ml shake flask. Biotransformation was confirmed by RP-HPLC analysis and further characterization done by ESI-MS.

Keywords: Betulin, microbial transformation, *Bacillus megaterium*, HPLC, Anti-HIV, Betulinic acid,

Utilisation of Food Industry Waste for Value Addition of Food Products Development

Dr Ashwini N Bellary

Department of Food Science and Nutrition, Community Science College, University of Agricultural Sciences, Dharwad, Karnataka-05

ABSTRACT

Papaya is the fruit of the *Carica papaya* plant. Papaya in raw or ripe form is widely used in cosmetic, textile, pharmacological and food processing. Processing of papaya produces about 30-35% of waste generation. The out graded/over riped papaya, its skin, seeds and uneven dices, rejected papayas, are the common waste produced by the processing industry. Dicing of papaya produces about 8.5% of peel waste, 6.5% of seeds, 32% unusable pulp (because of imperfection in cubes), and about 53% of final product. Total rind and seed wastes account for 10-20%. Considering this much amount of waste an attempt was made to utilise the papaya industry waste for isolation of bioactive compound and its application in food product. Spray drying is one of the technology where the liquids are concentrated to powder to increase the shelf life of the food products. In the present work the papaya processing waste was treated and enzymatically liquefied, converted to powder form by spray drying. Thus the product obtained was low in moisture content (5.49g/100g) high in total carotene content (42µg/100g) providing energy (326.8kcal). Thus the obtained powder could be utilised for food product development as in functional foods.

Keywords: Papaya, food industry waste, functional foods, spray drying

In-silico assessment of Biphenyl Dioxygenase activity from *Pandoraea Pnomenusa B-356* with different PCBs congeners

Neha Singh¹, Vikram Dalal², Pravindra Kumar³

Department of Zoology, Harsh Vidya Mandir (P.G.) College, Raisi, Haridwar, India

Department of Anaesthesiology, Washington University, Saint Louis, Missouri, USA

Department of Biotechnology, Indian Institute of Technology Roorkee, Roorkee, India

ABSTRACT

Polychlorinated biphenyls (PCBs) are ubiquitous xenobiotic compounds which are organic chemicals having carbon, hydrogen and chlorine atoms. The number and location of chlorine atoms in a PCB congener determines many of its physical and chemical properties. Polychlorinated biphenyls (PCBs) are among the most persistent chlorinated environmental pollutants, despite the long-term regulation related to their manufacturing protocols and usage. The discovery of many bacterial strains that are partially able to degrade PCBs has fuelled research directed towards the improvement of bioremediation-based strategies for the clean-up of PCB contaminated sites. Present work describes the screening of polychlorinated biphenyl (PCB) library with native Biphenyl dioxygenase (BPDO) structure from *Pandoraea pnomenusa* B-356, in order to evaluate the influence of the pattern and degree of chlorination on the catalytic activity of BPDO. Therefore, for that purpose, PCB congener library of 209 congeners was made and screened to elucidate the enhanced degradation abilities of BPDO. Through docking studies, the binding ability of BPDO from *Pandoraea pnomenusa* B-356 w.r.t. PCB congeners was measured and important active site residues involved in the interaction were also acknowledged. Moreover, results related to the particular geometry and electrostatic properties of chlorinated biphenyls can be useful to rationalize their specific and selective toxicities.

Keywords: Polychlorinated biphenyls, screening, geometry and electrostatic properties

Abbreviations used: PCBs- Polychlorinated biphenyls, BPDO- Biphenyl dioxygenase

Digitization of traditional ‘Kutch and Kathiawar embroidery motifs’ and access their marketability

Sarita Devi*, Sushila and Nisha Arya*****

Department of Fashion Design, Mandsaur University, M.P

Department of Fashion Design, Subharti University, U.P

Department of Textile and Apparel Designing, I.C College of Home sciences, CCSHAU, Hisar

ABSTRACT

3rd International Conference on “Global Initiative in Agricultural, Forestry and Applied Sciences for Food Security, Environmental Safety and Sustainable Development (GIAFAS-2021)”

Indian cultural and tradition are reflected through its magnificent and fabulous art and crafts. Embroidery has always been an integral part of Indian culture and Gujarat is famous for the embroidery of *Kutch* and *Kathiawar*, whose beauty lies in the rich designs, variety of motifs and stitches (Pandya and Dholakia, 2013). In the present study, traditional embroidery motifs of *Kutch* and *Kathiawar* were explored and collected for the creative designing. Top-ranked ten motifs were selected out of two hundred motifs for creative design development and thirty creative designs were developed with the help of Corel DRAW X3 software using selected traditional embroidery motifs. The selected designs with preferred colour ways were transformed into digital embroidery form. Design size, length of stitch and their density pertaining to the type of traditional embroidery stitch were assigned using Wilcom E2 embroidery software for development of selected home furnishing textile articles for product development. Respondents were evaluated the products on the basis of technique used (2.80), aesthetic appeal (2.40), placement of motif (2.80), colour combination (2.76), uniqueness of design (2.86), overall appearance (2.80) and price also. The study found that all the respondents rated the developed products with digital embroidery technique are excellent and also observed that, many respondents were ready to pay more than the suggested price.

Keywords: Traditional Embroidery, CorelDraw, Digitization, Designing, Product development

SYSTEM OF RAGI INTENSIFICATION AS AN EMERGING SRI

***S. Pazhanisamy¹, Rodda Chandana Devi², Vijayakumar³ and S.N. Sandeep⁴**

^{1&4}*Department of Agronomy, Dr.Rajendra Prasad Central Agricultural University, Pusa, Bihar.*

²*Department of Soil Science, Dr.Rajendra Prasad Central Agricultural University, Pusa, Bihar.*

³*Department of Agronomy, Annamalai University, Chidambaram, Tamil Nadu.*

ABSTRACT

Finger millet, commonly known as Ragi (*Eleusine coracana* G.), is an important small millet crop ranking third in India in area and production. It has pride of place in having the highest productivity among the millets after sorghum and pearl millet. It is being cultivated in India, especially in the states like Karnataka, Tamil Nadu, Orissa, Chhattisgarh, Jharkhand, Uttarakhand, Andhra Pradesh, Maharashtra and Gujarat for thousands of years. It is a highly nutritious food and is a great source to extract energy and top-per in the chart amongst nutrient consumption and achieves a high rank in grains. The Ragi is nutritionally comparable and even superior to other cereals, especially concerning protective nutrients. It has eight to ten times more calcium (344 mg/100 g) than wheat and rice and contains a good amount of iron, phosphorous, thiamine, and another nutrient, besides high calorific value. Also, the slowly digestible carbohydrates make it food for long sustenance. Hence, Ragi will play an important role in alleviating malnutrition and enhancing nutritional security that has turned fragile due to excessive dependence on few major food crops. But, drastic reduction in acreage of these crops, lack of input, water, labour availability and method of cultivation leads to reduce the production and productivity of ragi. Hence, SRI Technology uses less input, less seed, water, chemical fertilizers and pesticides. The System of Rice Intensification concepts and methods to applied the growing of finger millet. In India Pragati, the SRI method for rice began promoting the System of Ragi Intensification in 2011 in Koraput district, Odisha. System of Rice intensification is a proven technique that helps in increasing rice production in rainfed areas. Integrating SRI techniques for millet cultivation also showed similar results. It strives to produce get more production from less water and lesser seed but carefully managing the relationship between the plant and soil. This system of ragi intensification has resulted in a higher yield than the common method of cultivation.

Keywords: System of ragi intensification, input, nutrition value of millets, water productivity.

Combining ability and heterosis studies for agro-morphological and yield traits in hulled barley (*Hordeum vulgare* L.) under north-western Himalayan conditions

CHETAN GUPTA^{1*}, VIJAY RANA^{1,2}, AMIT RANA¹ AND PRIYANKA¹

¹*Department of Genetics and Plant Breeding, CSK Himachal Pradesh Krishi Vishvavidyalaya, Palampur (H. P.), India-176062*

²*Rice and Wheat Research Centre, Malan, CSK Himachal Pradesh Krishi Vishvavidyalaya, Palampur (H. P.), India-176047*

ABSTRACT

3rd International Conference on “Global Initiative in Agricultural, Forestry and Applied Sciences for Food Security, Environmental Safety and Sustainable Development (GIAFAS-2021)”

Barley is one the most important crops worldwide grown mainly for food, feed and drinks. The main aim of this study was to assess the combining ability of barley parents and estimate the inheritance pattern for some agro-morphological and yield traits for future breeding programmes. The experimental material comprised of 28F₁ crosses developed by crossing 8 commercial varieties/germplasm/local lines as per diallel mating design (8×8, excluding reciprocals) in *Rabi* 2018-19 and further evaluated in Randomized Block Design with three replications during *Rabi* 2019-20. Combining ability analysis revealed significant differences for all the traits studied indicating wide genetic variability among the genotypes and prevalence of additive variance for the all the traits. GCA effects indicated that parents VLB 118, HBL 804, BHS 380 and HBL 316 were overall good general combiners for agro-morphological and yield traits. Twelve cross combinations *viz.*, HBL 713 × BHS 380, HBL 713 × BHS 400, HBL 713 × Losar, HBL 316 × HBL 804, HBL 316 × BHS 380, HBL 316 × BHS 400, HBL 804 × BHS 380, HBL 804 × VLB 118, BHS 380 × BHS 400, BHS 380 × Local Ropa, VLB 118 × Local Ropa and VLB 118 × Losar were identified as best on the basis of seed yield together with other component traits. On the basis of standard heterosis, crosses *viz.*, HBL 713 × BHS 380, HBL 804 × BHS 380, HBL 804 × VLB 118, BHS 380 × BHS 400, BHS 380 × Local Ropa and VLB 118 × Losar were identified as promising for agro-morphological and yield traits and are expected to throw transgressive segregants. Therefore, results from the present study will be useful in formulating future hybridization breeding programs for barley improvement.

Effect of different spacings of poplar on growth, yield attributing traits and fodder yield of cowpea under silvi-pastoral system

***Sneh Yadav , R. S. Dhillon and J.S.Ranawat**

Department of Forestry, CCSHAU, Hisar- 125004

ABSTRACT

A field experiment was conducted during 2018–19 to study the growth and production of fodder cowpea (var. RC-19) under different spacings, i.e. 3×3 m, 4×3 m, 5×3 m, 6×3 m, 7×3 m and 8×3 m of two and half-yr-old poplar-based agroforestry system. The objective of this study was to evaluate the productive yield of cowpea as single crop and mixtures in an agroforestry system at forestry farm, CCSHAU, Hisar. The experimental design was randomized block design with three replications. The results depicted that the maximum plant height (9.70 cm), leaf area index (2.3), the highest number (20.17) of plant population of cowpea at 15 DAS was recorded in 8×3m spacing followed by 7×3m, 6×3m and least under 3×3m. A similar trend of growth of cowpea was observed after 30, 45, 60 and 75 DAS as it follows the increasing trend with increase in spacing. Among the different spacings of poplar, the fodder yield of cowpea was recorded maximum (8.95 t/ha) under 8×3 m followed by 7×3 m (7.24t/ha), 6×3 m (6.06t/ha), 5×3 m (4.45t/ha), 4×3 m (2.99t/ha) and minimum (2.20t/ha) under 3×3 m spacing. All the growth and yield attributes of cowpea were recorded lesser under different spacings of poplar as compared to the control (crop in open). The reduction in fodder yield of cowpea under spacings 3×3 m, 4×3 m, 5×3 m, 6×3 m, 7×3 m, 8×3 m of poplar was 81.71, 75.14, 63.00, 49.62, 39.81 and 25.60 per cent, respectively over control (sole cowpea), indicating that cowpea is more sensitive to shade. While maximum (2.03) benefit to cost ratio was observed under Poplar+ cowpea combination in closer plant geometry of 3×3 m due to more number of trees.

Keywords: Agroforestry, Cowpea, poplar, spacing, Fodder yield

Role of Genetics & Plant Breeding In Maintaining Positive Relationship Between Food Security, Environmental Safety & Sustainable Development.

NISHTHA^{*1}, SHANZA BAIG² & AKASH SHUKLA³.

Forest Genetics, Division of Genetics & Tree Improvement, Forest Botany Division, Forest Research Institute, Dehradun, U.K.

Forest Management, Silviculture, Forest Management & Agroforestry Division, Jabalpur, M.P.

ABSTRACT

Food security is fundamental need for human existence. Food security is said when all the people at all times have physical, social, and economic access to sufficient safe and nutritious food that meets their food preferences and dietary needs for an active and healthy life. There are four pillars of food security which is availability, accessibility, utilization, stability. Food security and environment safety are the two complementing element for our sustainable development and future. We need novel solution for our future food security, environment safety and to maintain sustainability. Plant breeding and genetics has considerably increased agricultural yields in recent decades and at the same time, intensification of farming has had negative environmental effects. The food security is under immense pressure of the

increasing world population growth, increasing demand of food and the global food crisis began with the sudden increase in food price all over the world. There are various new plant breeding technologies which helps in maintaining food security, environment safety and sustainability. The Primary objective of plant breeding is to increase the crop yield and the secondary objective is quality improvement for high agricultural output to met the global food security and to maintain sustainable balance. Gene editing methods such as CRISPR/Cas system that was developed in 2012 is now widely used in food security by maintaining desirable plant trait and also maintains sustainability. MAS a widely used plant breeding technique manipulates the genomic regions that are involved in the desirable trait of interest through DNA markers and helps in maintaining food security. Food security can be maintained with the help of GMOs in which genes coding for desirable traits have been inserted through the process of genetic engineering. Nutritionally enhanced food crops with increased bioavailability are developed using modern biotechnological techniques, conventional plant breeding and agronomic practices refers to biological fortification or biofortification. Biofortification helps in fighting hidden hunger or micronutrient malnutrition and also helps in maintaining food security and sustainability. The use of new plant breeding techniques can help to increase crop diversity, raise yield potential, provides better resistance to pests and diseases, makes crop more resilient to environmental shocks and ofcourse new plant breeding techniques helps to maintain sustainable food production and nutritional security.

Keywords- MAS, Gene editing, CRISPR/Cas, Biofortification, hidden hunger.

Genetic diversity in *Bipolaris maydis* isolates inciting maydis leaf blight of maize Manjeet Singh* and Rakesh Mehra

Department of Plant Pathology, CCS Haryana Agricultural University, Hisar-125004

ABSTRACT

Maize is one of the most important cereal crops in the world and also known as queen of cereals. Among various diseases of maize, maydis leaf blight incited by the fungus *Bipolaris maydis* has attained the status of the economically important disease. Six isolates of *Bipolaris maydis* (viz., Udaipur, Gogunda, Fatehnagar, Marli, Dabok and Jhadol) were collected from different locations of Rajasthan and their genetic variability was studied by using random amplified polymorphic DNA (RAPD) and internal transcribed spacer (ITS). Data generated from 18 RAPD and 2 ITS polymorphic primers from six *B. maydis* isolates was analysed with UPGMA by using NTSYS and dendrogram was constructed. The cluster analysis of *B. maydis* isolates using combined data of RAPD and ITS primers depicted wide range of genetic relatedness, which ranged from 0.72 to 0.95, i.e., 72 to 95 per cent among the isolates of *B. maydis*. All primers showed 100% polymorphism with fragment size varying from 0.25-3 kb. The UPGMA analysis differentiated the six *B. maydis* isolates into two groups i.e. group A and group B at similarity coefficient of 0.74. The group A consisted of one isolates of *B. maydis*, in this isolates Udaipur showed 75 per cent genetic similarity with isolates of Gogunda, Marli Dabok and Jhadol On the other hand group B consisted of four isolates of *B. maydis*, in this isolates of Gogunda and Jhadol showed 84 per cent genetic similarity. But isolate Fatehnagar did not fall in to any group at the similarity coefficient of 0.72, Fatehnagar isolate was wide distance pair showing 72 per cent similarity with other isolates of *B. maydis*, whereas maximum closeness (95%) was observed between Marli and Dabok isolates in group B. Analysis of *B. maydis* isolates from maize by phylogenetic tree revealed distinct clusters showing genetic variation.

Epidemiology of maydis leaf blight of maize caused by *Bipolaris maydis* (Nisikado and Miyake) Shoemaker in relation to weather parameters

Manjeet Singh* and Rakesh Mehra

Department of Plant Pathology, CCS Haryana Agricultural University, Hisar-125004

ABSTRACT

Maize (*Zea mays* L.) is one of the most important cereal crops in the world and popularly known as queen of cereals. It is third major crop in India after wheat and rice. About 65 pathogens infect maize and out of these, maydis leaf blight (MLB) caused by *Bipolaris maydis* (Nisikado and Miyake) Shoemaker is considered as one of the most serious disease. The disease is widely distributed in India during *kharif* season. MLB appears every year with incidence ranging from 20-85 per cent in Haryana. The disease has the potential to reduce the grain yield upto 41 per cent in susceptible cultivars. Disease development and progression of maydis leaf blight on five different genotypes of maize sown on four different dates viz., first fortnight of June, second fortnight of June, first fortnight of July and second fortnight of July during *kharif* 2015 was recorded. Disease intensity in all maize genotypes was observed maximum in Ist date of sowing ranging followed by IInd date of sowing and IIIrd date of sowing, however in IVth date of sowing the disease intensity

3rd International Conference on “Global Initiative in Agricultural, Forestry and Applied Sciences for Food Security, Environmental Safety and Sustainable Development (GIAFAS-2021)”

was lower. The correlation coefficients were calculated for all the maize genotypes with date of sowing and also for average of genotypes with weather parameters. Results showed that maximum temperature, sunshine (hrs) and rainfall was positively correlated with the disease intensity. These findings will be helpful in developing integrated disease management strategies for the control of maydis leaf blight of maize.

Effect of root dip treatment of onion seedlings for the management of *Thrips tabaci*

Rabiya Basri^{1*} and M. Shafiq Ansari²

¹*School of Agriculture, ITM University, Gwalior (MP), India 474001*

²*Department of Plant Protection, Aligarh Muslim University, Aligarh, India 202002*

ABSTRACT

Onion thrips causes damage directly by sucking sap from the plant and indirectly by transmitting Iris Yellow Spot virus. *Thrips tabaci* usually present at the base of inner leaves of onion foliage, hence it is difficult for insecticide sprays to directly reach to these minute organisms. Therefore, root dip treatment has been provided to the onion seedlings before transplanting. Seedlings were exposed to the insecticides; imidacloprid (0.04%), fipronil (0.007%), thiamethoxam (0.02%), cypermethrin (0.01%) for 6 and 12 hr which effectively suppressed thrips infestation till March and yield was also increased compared to control. A significantly ($P < 0.0001$) lowest density was recorded on thiamethoxam (8 thrips/plant) and 34.83 thrips/plant in untreated in 13th WAT, 2015-16. Imidacloprid reduced the density to 0.08 thrips/plant compared to 9.91 t/p in 6th WAT, 2016-17. Maximum marketable yield was obtained from imidacloprid (16.34 t/ha) followed by thiamethoxam (15.72 t/ha), fipronil (13.05 t/ha), cypermethrin (12.01 t/ha) compared to untreated in 2015-16. However, bulb yield was higher in 2016-17 than 2015-16. Highest yield was obtained from imidacloprid (25.12 t/ha) and thiamethoxam (24.53 t/ha), compared to untreated (9.41 t/ha). Highest benefit cost ratio was calculated for thiamethoxam (67.05:1) and imidacloprid (62.22:1) in 2015-16. Thiamethoxam and imidacloprid were found more effective compared to the other insecticides also gave better results in terms of yield. This study suggests that imidacloprid @ 0.04% and thiamethoxam @ 0.02% for 12 hours prior to transplanting protect onion plants from thrips infestation up to 11-12 WAT. Seedling root dip treatment would definitely reduce the number of insecticide sprays and thus it will save the beneficial insects as well as the environment.

WATER CONSERVATION BEHAVIOUR AMONG FARMERS OF THOOTHUKUDI DISTRICT

Dr. R. Rajasekaran^{1*} and N. Dhivya²

¹*Department of Agricultural Extension and Rural Sociology, Tamil Nadu Agricultural University, Coimbatore (641 003) Tamil Nadu, India.*

²*Department of Social Sciences, Agricultural College and Research Institute, Tamil Nadu Agricultural University, Killikulam, Vallanadu, Thoothukudi - 628 252 Tamil Nadu, India.*

ABSTRACT

Water is an extremely valuable resource is becoming scarce resource day-by-day hence it is necessary to follow water conservation practices. The main objective of the study is to identify the water conservative behaviour of the farmers. The study was conducted in Thoothukudi district of Tamil Nadu. Data was collected using questionnaire and direct interview method. Majority of them had knowledge about water conservation practices when it comes to adoption only few practices are being adopted by the farmers viz, crop rotation, desiltation of ponds, micro catchment technology and farm pond. These shows that farmers should be provided with more information's and they should be motivated to adopt various location specific water conservation practices.

Keywords: Adoption, Climate change, Ex-post facto research, Farmers behaviour, Knowledge

IMPACT OF PANDEMIC COVID-19 ON FARMING SECTOR AND FARMER'S LIVELIHOOD IN SALEM DISTRICT

Dr. R. Rajasekaran^{1*} and N. Dhivya²

¹*Department of Agricultural Extension and Rural Sociology, Tamil Nadu Agricultural University, Coimbatore- 641 003, Tamil Nadu, India.*

3rd International Conference on “Global Initiative in Agricultural, Forestry and Applied Sciences for Food Security, Environmental Safety and Sustainable Development (GIAFAS-2021)”

²*Department of Social Sciences, Agricultural College and Research Institute, Tamil Nadu Agricultural University, Killikulam, Vallanadu, Thoothukudi - 628 252 Tamil Nadu, India.*

ABSTRACT

The pandemic COVID-19 continues to threaten the global food system, the role of state becomes much more pertinent, in order to protect and safeguard the livelihoods of millions of people associated with the agriculture systems. The specific objective of this study was to identify the impacts faced by farmers in their livelihood as well as in their day-to-day farming activities due to pandemic COVID-19. The study was conducted in Salem district of Tamil Nadu. The needful information's was collected using well structured and pre-tested questionnaire by face to face interview method. It was found that majority of them felt their economical, psychological, physical and social health had been affected due to this pandemic situation. They also faced problem in their regular farm practices like intercultural operations, harvesting, post harvesting, storage and marketing of their produce. Suggestions such as transparency in market information's, storage facilitations for harvested produce, preventing the migration of farm labourers, providing financial support to some extent to the needful farming population can be implemented to safeguard the livelihood of peoples involved in agricultural activities.

Keywords: COVID-19 impact, Farming sector, Farmers livelihood, Problems and Suggestions

Gene targeting in crop plants: by insert, remove or replace using advanced site-specific engineered nucleases

Ruchi Agarwal*, Rima Kumari and V. K. Sharma

Department of Agricultural Biotechnology and Molecular Biology, Dr. Rajendra Prasad Central Agricultural University, Pusa (Samastipur) 848125, Bihar, India

ABSTRACT

Gene targeting (GT) is a genetic technique that uses homologous recombination (HR) to change an endogenous gene. It can be used to delete a gene, add a gene and introduce point mutations. Unfortunately, the frequency of targeted integration via HR was so low in comparison to random integration that GT could not be established as a feasible technique in higher plants. In some cases, the over expression of proteins involved in HR or the use of negative selectable markers improved GT to a certain extent. The main limitation was the absence of tools needed to induce double strand break (DSBs) at specific site in the genome. A chromosome break is created at target site needs different types of engineered nucleases such as meganucleases, Zinc finger nucleases (ZFNs), transcription activator-like effector nucleases (TALENs) and clustered regularly interspaced short palindrome repeats (CRISPR/Cas). Nuclease-induced double-strand breaks (DSBs) can be repaired by nonhomologous end joining (NHEJ) or homology-directed repair (HDR) pathways. ZFNs and TALENs genome editing techniques search valid sequences with proteins, while CRISPR/Cas based on guide RNA. Designing of single guide RNA is more easier than assembling multiple protein domain coding modules. CRISPR/Cas system is more efficient, feasible and more accurate tools for genome editing as it can edit multiple target gene simultaneously. GT allows the construction of 'safer' transgenic crops, without any unknown position effects which is frequently observed in the case of random integration.

To evaluation of leaf color chart for need-based nitrogen management in rice crop in Gwalior district of M.P.

Shaillesh Kumar Singh, Rupendra Kumar Singh, Anil Kumar Singh and R. K. S. Tomar

R.V.S.K.V.V., Krishi Vigyan Kendra, Datia (M.P.)

ABSTRACT

On farm Trails was conducted on farmer's field in Gwalior district of Grid Agro-climatic region of the M.P. during the year 2019-20 to evaluation of leaf color chart for need-based nitrogen management in rice. Nitrogen use efficiency (NUE) in rice is low due to the inefficient management of fertilizer N by farmers. The evaluated a leaf color chart (LCC) as a simple tool for time of the application and rate of nitrogenous fertilizer use in farmers' fields in rice crop in Gwalior District of M.P. Application of N fertilizer whenever leaf greenness was less than shade 4 on the LCC (the critical LCC value) produced rice grain yields on at par with blanket recommendation of applying 100 kg N ha⁻¹ in three equal splits dose, The results revealed that use of LCC that an average saving of 21% N fertilizer. In most situations, there was no significant advantage of applying 20 kg N ha⁻¹ as basal N at transplanting on grain yield and NUE of rice

3rd International Conference on “Global Initiative in Agricultural, Forestry and Applied Sciences for Food Security, Environmental Safety and Sustainable Development (GIAFAS-2021)”

compared with no basal N. Use efficiencies of fertilizer N were higher when N was applied using LCC with a critical value of 4 than the recommended practice of applying 100 kg N ha⁻¹ in three equal split doses on all Fields. The LCC with a critical value of 4 for real-time N management can be efficiently used to increase NUE in all types' rice cultivars presently popular with the farmers. The LCC is a cheap and easy-to-use tool that allows real-time N management by farmers of on a large area leading to improved fertilizer N use efficiency, and reduced risks associated with fertilizer N application.

Cultivation & Choice of Rabi Vegetables for Homestead Nutritional Gardens in Dibrugarh District of Assam

Dhiraj Bhattacharjee¹, Archita Ojah²

Department of Horticulture, Department of Agronomy, Assam Agricultural University

ABSTRACT

Nutrition gardening is particularly important in rural areas where people have limited income-earning opportunities and poor access to markets. These gardens are becoming an increasingly valuable source of food and additional-income for common households in semi-urban and urban areas. One primary objective of this survey is to develop a nutrition-based garden model for continuous supply of fresh vegetables for family use or sale in the local market. Such a garden is gaining popularity among urban dwellers as land is a limiting factor and very often vegetables especially the leafy ones can be easily raised in limited available area and with locally available resources. A survey was conducted in 5 different blocks of Dibrugarh district to find out the commonly grown vegetables by different farmers. Cucurbitaceous and Brassicaceae crops were seen to be commonly cultivated among many others. This article elaborates on the vegetables usually preferred by the cultivators and a scientific model that can replace the conventional model practiced till date.

Keywords: Cucurbitaceous, Brassicaceae, Dibrugarh, Nutrition, Rabi.

Studies on the tolerance potential of *Eisenia fetida* towards Low density polyethylene microplastics .

Deachen Angmo¹, Rahil Dutta¹, Jaswinder Singh², Adarsh Pal Vig^{1*}

¹Department of Botanical and Environmental Sciences, Guru Nanak Dev University, Amritsar, Punjab 143005, India

²Post Graduate Department of Zoology, Khalsa College, Amritsar, Punjab 143005, India

ABSTRACT

Microplastic pollution is an emerging issue experiencing globally, heavy production and massive consumption of plastics led to accumulation of plastic both in the ocean and on the land. Microplastics are very small pieces ($\leq 5\text{mm}$) of various shapes and sizes of plastics which have a potential to travel through the soil and into the organism. Microplastics are ubiquitous and have detected in different ecosystems. There are multiple sources of microplastics like sewage sludge, mulching practices in agricultural sector and surface runoff. Microplastics entering the soil not only adsorb organic pollutants but also act as carrier of various heavy metals. Smaller the size of plastics higher the threat it pose to the whole ecosystem. Microplastics have been demonstrated to cause adverse effects on soil health and function and their contamination in soil will inevitably lead to accidental ingestion of microplastics by soil organism. Once microplastics are ingested or accumulated by soil animals, they can cause physical tearing of tissues and organs. In addition microplastics hold potential to poses health risk to human also. Earthworm is an important soil biota and important species in ecotoxicological risk evaluation of soil pollution caused by microplastics and other toxin. The effect of microplastics on aquatic animals are widely documented. However, effects on terrestrial organism received less attention. The reported level of microplastics contamination in soil is up to 67 g kg⁻¹ . It is essential to explore the potential effects of microplastics employing different concentrations as well as sizes and types on soil organisms. Therefore, the objective of this study is to evaluate the tolerance capacity of *Eisenia fetida* towards low density polyethylene (LDPE) microplastics by assessing growth, fecundity rate and effective concentration of earthworm. In this study the tolerance level of *Eisenia fetida* at lower concentration is greater which shows negligible effects on bio-mass as well as fecundity rate and increase in biomass has been observed with increase exposure period and there is no obvious distinction between lower concentration treatment in terms of biomass and fecundity rate. whereas at the high concentration biomass has been decrease. Present study revealed that avoidance of earthworm to low density polyethylene exposure with (EC₅₀) effective concentration is 298g kg⁻¹.

Keywords: *Eisenia fetida*, Low density polyethylene (LDPE), Microplastics.

Record on egg parasitoids of the family Trichogrammatidae (Hymenoptera: Chalcidoidea) from Chhattisgarh, India

¹Mohsin Ikram*, ²Rajendra Prasad, ³Mahipal Singh, ⁴Salman Khan, ⁵Manendra Kaneria, ⁶Manish Kaneria

^{1,2,3} School of Agriculture, Uttarakhand University, Dehradun (UK) India

⁴Forest Survey of India, Central Zone, Nagpur (Maharashtra)

^{5, 6} Forest Entomology Discipline, Forest Protection Division, Forest Research Institute, New Forest, Dehradun (UK)India

ABSTRACT

Trichogrammatid egg parasitoids are very minute, generally less than a half millimetre and these are parasitizing various insect pests mostly belonging to insect orders Lepidoptera, Hemiptera and a few to Coleoptera, Diptera and Thysanoptera. Parasitoids of Trichogrammatid genera: *Aphelinoidea*, *Paracentrobia* and *Ufens* commonly parasitize the Hemipteran eggs on of cash crops, orchards, as well as forest tree species. Trichogrammatids are universally accepted bio-control agents of lepidopterous pests of agricultural and forestry importance. They are very important and well accepted in biological control of insect pests. Several species of the genus *Trichogramma* have been used in applied biological control of insect pests.

During the present survey (February-March and October-November 2017), several trichogrammatids have been collected from forestry and agro forestry areas of Chhattisgarh, India. Present paper includes a brief account of 10 species of trichogrammatid (*Aphelinoidea gwaliorensis*, *Lathromeroidea ajmerensis*, *Oligosita debaiensis*, *Oligosita gilyus*, *Pseudoligosita nephoteticum*, *Oligosita novisanguinea*, *Oligosita sanguinea*, *Paracentrobia magniclavata*, *Ufens gurgaonensis* and *Ufens jaipurensis*), which are recorded as indigenous egg parasitoids. These are widely distributed in Chhattisgarh.

Keywords: Hymenoptera, Trichogrammatidae, Egg parasitoids, Biological control.

Assessment of adopted roof top rain water harvesting systems : A case study in Dharwad district of Karnataka state

Jeevitha K. M¹ and Veena S. Jadhav²

Department of Family Resource Management, College of Community Science, UAS Dharwad

ABSTRACT

Water is universal need and considered the principle limiting factor for human life. Due to population explosion community is facing serious issues related to water quality and quantity. During the past two decades significant development in rain water harvesting has taken place in the urban and rural areas of India. Rain water harvesting is seen as the only solution for providing domestic and productive water. Rain water harvesting system could be used as a means of household water security, with this perspective this research study was conducted in rural and urban areas of Dharwad district, Karnataka state during 2016-17 with the objective to assess potential of already adopted rain water harvesting systems in making houses water sustainable. From rural areas, ‘Sri Guru Basava Mahamane’ situated in the Managundi Village of Dharwad district was chosen for the case study. They invested Rs. 2 lakhs in constructing the system. Their water requirement per day is about 300-400 liters. Water is collected from the roof of 480 square feet. The open 60,000 liter capacity storage tank. It is called as ‘Basava Sagara’. It meets the demands of drinking, naturopathy and other purposes. This initiative has inspired local farmers to adopt farm pond in their agricultural fields. It has supplemented their water demands for agricultural needs. It has helped them grow even during non-rainy seasons, thus extending their cropping seasons. They grow vegetables, green leafy vegetables, maize and some fodder crops.

Keywords: Population explosion, Rain water harvesting, Rain water harvesting system and Non-rainy seasons.

RECORD OF THE GENUS *PSEUDOSHIRAKIA* ACHTERBERG (INSECTA:HYMENOPTERA:BRACONIDAE) FROM INDIA, WITH DESCRIPTION OF ONE NEW SPECIES

ARSHAD ALI HAIDER

Department of Zoology, Maharashtra College of Arts, Science & Commerce, Mumbai Central (E), Mumbai-400 008

ABSTRACT

Braconids are the most widely used parasitoids in the field of biological control programmes. This genus is known only from its type species from the Palaerctic (Japan, China) and Oriental (Taiwan) regions. The genus *Pseudoshirakia* Achterberg (1983) with one new species *P. aligarhensis* sp. nov. is recorded for the first time from India. Among the parasitic Hymenoptera, the species belonging to the genus *Pseudoshirakia* of the family Braconidae are not only known to keep pest population under control in their natural habits but also extensively used in the classical biological control programmes directed against economically important pest species, mainly belonging to the order Lepidoptera, Coleoptera, Diptera, Neuroptera, Psocoptera and Hemiptera.

The genus *Pseudoshirakia* was described by Achterberg (1983) to accommodate *Bracon yokohamensis* Cameron (1910) as its type species. It is closely related to the genus *Mesobracon* Szepliget (1902). However, it differs from *Mesobracon* for having scapus subcylindrical, apically truncate in dorsal aspect; notauli present except for the posterior third of the mesoscutum; median area of metanotum formed into distinct carinae anteriorly; 2nd submarginal cell of fore wing short, strongly widened distally; fore wing veins C+SC+R and 1-SR forming an angle of less than 90°; vein cu-a of fore wing interstitial or virtually so; tarsal claws with pointed basal lobes; metasomal tergites smooth or coarsely sculptured; antero-dorsal aspect of tergite first steep.

New species of this genus are added to the existing fauna of Indian Braconidae. This information will be useful for both taxonomists as well as applied entomologists engaged in the field of biological control of economically important crop pests. The overall information has been compiled after a careful consultation of the available literature. The approach of biological control is not only a better replacement for chemical control but simultaneously prove to be a permanent and comparatively inexpensive method against insect pests.

Keywords: Insecta, Hymenoptera, Braconidae, *Pseudoshirakia*, Parasitoids, India

Effects of grazing herbivore on grasshopper population and nature on Indian vegetations

Md. Humayoon Akhtar¹ and Manish Bhardwaj²

¹*Department of Zoology, Koshi College, Khagaria 851205, Bihar*

²*Department of Zoology, ¹Department of Zoology, S.N. Sinha College, Warisaliganj, Bodh Gaya – 824234, Bihar, India*

ABSTRACT

Grasshoppers (Orthoptera: Acrididae) are jumping insects generally feeds upon grasses, weeds and cultivated crops thus considered as agricultural pests. Since the beginning of civilization, locusts and grasshoppers have been among the most devastating threats to agriculture. This group of insects contains hundreds of pest species and affects the livelihoods. Their populations can quickly grow to catastrophic levels, if conditions are favourable. Crop damage is likely to be greatest in years when dry weather accompanies high populations. Unfavourable environmental conditions reduce natural vegetation and populations of grasshoppers move to cultivated crops and may damages the standing crops.

Grasshoppers spent less time on feeding and resting on grasses, but more time on switching and resting on forbs under cattle grazing and mixed grazing with cattle and sheep. In contrast, the grasshoppers spent more time on feeding but less time on switching and resting on forbs under sheep grazing. The behavioral changes were also potentially linked to grasshopper abundance in the context of grazing management. The responses of grasshopper behavior and abundance to grazing may be largely triggered by altered vegetation and microclimates. Such behavioral flexibility of grasshoppers must be considered when large herbivores are recognized as a management tool for influencing grasshopper abundance, and grazer species should be paid more attention both individually and jointly for better grassland conservation.

Keywords. grasshoppers, grass, grazing, herbivore, abundance

Rapid Assessment of Butterfly Diversity in Rajgir Wildlife Sanctuary, Bihar, India

Manish Bhardwaj*¹ and Md. Humayoon Akhtar²

¹*Department of Zoology, S.N. Sinha College, Warisaliganj, Magadh University, Bodh Gaya – 824234, India*

²*Department of Zoology, Koshi College, Khagaria – 851205, Bihar, India*

ABSTRACT

Rapid loss of biodiversity due to urbanization is estimated to be between 1,000 and 10,000 times higher than the natural extinction rate. With only 2.4% of world's land area, India accounts for 7-8% of all recorded species, of which 4.95% area is under various degrees of protection. As it is very challenging to increase area under forest cover, urban/semi-urban landscapes provide good opportunity to boost biodiversity conservation efforts. Semi-urban landscapes provide an interspersed matrix of various habitats connected with ecotone areas which serve as corridors between island habitats supporting conservation in protected areas.

Butterfly sampling was conducted in various habitats (Mixed forest, scrub forest, plantations, gardens and human influenced habitats) in a Wildlife Sanctuary and semi-urban landscape in and around Rajgir Wildlife Sanctuary. We encountered a total of 983 individuals of 57 butterfly species belonging to 42 genera under five families. Inventory completeness was approx. 60-65% of estimated butterfly species richness which is considered as 'reasonable' for taking conservation decisions. Highest species richness was recorded in heterogeneous habitats while least in homogeneous habitats. Generalist species were abundant in open habitats like human influenced habitats and scrub forest while specialist species were restricted to habitats like plantations, gardens and mixed forest. Observations were also taken on their feeding habits and diurnal activity patterns. These results suggest that decrease in green areas (agriculture and forests) negatively impact biodiversity composition in terms of generalist and specialist species composition.

The role of rapid assessments and butterflies as model taxa in selecting and prioritizing areas and planning conservation strategies in remnant urban/semi-urban ecotone habitats will be discussed.

Keywords: Butterflies, conservation, inventory completeness, semi-urban landscapes, Wildlife Sanctuary

IMPROVED BIOMASS STOVES IN RURAL AREA -A BOON

Dr. Renuka S. Salunke and Dr.S.S.Dolli

Department of Family Resource Management, University of Agricultural Sciences Dharwad. 580005

ABSTRACT

Inefficient combustion of solid fuels emits high concentrations of particulate matter (PM) and other harmful emissions. A strong association has been shown between household air pollution (HAP) and acute lower respiratory infections (ALRI) in children, and chronic obstructive lung disease (COPD) and lung cancer in adults. As a result of the magnitude of these adverse health impacts, household air pollution from burning solid fuels in primitive cook stoves is the primary environmental cause of death. Keeping this in view a study was conducted in two villages namely Timmapur Village of Dharwad district and Bhaganagar village of Vijayapur district. Interview schedule was used to elicit required information. It revealed that about 80 per cent of the women were illiterate in Timmapur and 76.70 per cent of the women were illiterate in Bhaganagar. Cent per cent of the women had both the traditional and improved biomass stove in both Timmapur and Bhaganagar village. In both Timmapur and Bhaganagar villages quantity of ash, charcoal and smoke after food preparation was significantly varied between improved biomass stove and traditional stoves in both the villages. Using improved biomass stove it saves half an hour to 1 hour per day and also found that the reduction in the carbon level and minimized the effect on health problems like respiration problem, irritation of throat, cough by using improved stove and it helps to maintain the cleanliness of home environment and as well as surroundings. The consumption of fuel wood in improved biomass stove was 720 kg/ /month/100 families whereas, the traditional stove consumes 1200kg /month/100families. Hence by using improved biomass stove on an average 384 trees/ year/100 families could be saved.

Keywords: Energy, Biomass, Carbon Emission, Indoor pollution, Improved Chula

Detection of Flow of Seeds in the Seed Delivery Tube and Checking Status of Seed Delivery Tube of a Seed Drill

Raushan Kumar^{1*}, Rajat Arya¹, Arun Kumar²

G.B. Pant University of Agricultural and Technology, Pantnagar-263145

ABSTRACT

Sowing is one of the most important operation for raising crops in which proper placement of seed in the soil for optimum growth is much desired. Seed is an important input in agriculture so it is necessary to minimize the seed loss and maintaining the proper germination condition of seed. Proper placement of seed during sowing operation is highly desired for optimum growth and high productivity. This is achieved by using seed drill/planter powered by tractor, power tiller, draught animal or human being. There is some concern associated with operation of seed drill during the field operation, like blockage of seed delivery tube in trashy field condition. The farmer may not be able to identify the seed blockage problem in the seed delivery tube during sowing because sowing is done below the soil surface. The seed blockage is a major problem during sowing, which creates a large unsown area. For eliminating these problems, we have developed a detection system of flow of seeds in seed delivery tube. Detection system includes a set of sensors, Arduino UNO and suitable arrangement for attaching detection system in seed delivery tube. These detection system gives information about status of seed delivery tube blockage. The status of seed delivery tube mainly includes missing, normal and blockage.

Keywords: Arduino, Precision sowing, Seed delivery tube blockage and Sensors.

Ananas comosus Peel: A Potential Phytoremedy towards Cancer

Shashi Soni and Ena Gupta

Department of Family and Community Sciences (H.Sc.), University of Allahabad (Prayagraj)

ABSTRACT

Ananas comosus (pineapple) is a wide growing crop in the World and ranks third in tropical fruit consumption and production. Its massive utilization in the canning industry leads to the generation of by-products in enormous amount like as crown, peel and core. Peel of pineapple accounts the largest from total waste production which exhibits various bioactive compounds like myricetin, chlorogenic acid, ferulic acid, gallic acid, epicatechin, catechin, quercetin, trans-cinnamic acid, salicylic acid, p-coumaric acid, tannic acid etc. It also provides best role in ethnomedicine. Cancer is a fatal disease which affects the cells of the body that consequently injures DNA of the cells and this injury accumulates. Many studies suggested that waste extracts of fermented and unfermented pineapple peel shows anti-carcinogenic activity effects against various human cancer cell lines viz A549 (lung cancer), MCF-7 (breast cancer), HCT116 (colorectal carcinoma), HT29 (colon cancer) closed to the values of doxorubicin whereas no anti-cancer activity was reported against HL-60, HFB4 (normal cell lines) and HepG2 (liver cancer). In conclusion, the peels generated as pollutant in environment could be transformed into worth as an eco-friendly agent for the prevention of cancer against different and many cancer causing cell lines.

Keywords: *Ananas comosus*, anti-carcinogenic, cancer cell lines, eco-friendly, bioactive compounds.

Effect of germination on nutritional and anti-nutritional components of Adzuki bean

Qurat Ul Eain Hyder Rizvi*, Krishan Kumar, Priyanka Thakur, Divya Chauhan, Naseer Ahmed.

Department of Food Technology, Dr. Khem Singh Gill Akal College of Agriculture, Eternal University, Baru Sahib, Sirmour, HP- 173101

ABSTRACT

Adzuki bean (*Vigna angularis*) is the important legume with high protein and amino acid content that makes them a suitable cheap source for fortification of various cereal diets in most economies in transition. Many phytochemicals found in whole plant foods can help preserve vascular health and diminish cancer risk; direct antioxidant activity may mediate much of their benefit. Natural antioxidants are compounds that detoxify reactive oxygen species and prevent their damage to cellular macromolecules and organelles through different mechanisms. Adzuki bean is a good source of essential fatty acids, fiber, minerals and phytochemicals such as polyphenols and phytates. Plant

protein of legumes has been found to play an important role in various favorable physiological responses, such as reducing kidney and heart diseases, lowering the sugar indices of diabetic patients, increasing in satiety, and reducing the chances of cancer. The raw grains are rich in vital nutrients but contain some anti-nutritional components. Adzuki sprouts are one of more valuable dietary supplements which may be considered as functional food. Sprouting reduces anti-nutritional factors and increases the bioavailability of macro and micronutrients and also affects phytochemical levels. In the present study, the adzuki bean was germinated for 72 h and was studied for nutritional and anti-nutritional properties at 24, 48, and 72 h intervals. Germination for a prolonged time significantly increased the antioxidant potential of the sprouted adzuki bean. The protein content of adzuki bean increased from 19.56 (raw grains) to 23.45% after germination for 72 h. The fat content was observed to decrease from 3.16 (raw grains) to 1.95% after germination for 72 h. The phenolic content was observed to increase from 22.78 mg/g (raw grains) to 25.58 mg/g, after germination for 72 h. Similarly, the antioxidant content in adzuki bean increased from 9.74 to 16.67% during germination for 72 h. Moreover, There was a reduction in anti-nutritional components of adzuki bean during germination. The phytic acid content of adzuki bean decreased during germination at 72 h from 6.52 (raw grain) to 3.45 mg/g. The tannin content was reduced from 6.09 to 3.56 mg/g. Results attained during sprouting that an increase in germination time modified the bioactive components and anti-nutritional components of the adzuki bean. Hence, it can be concluded that germination increased the nutritional components and reduced the anti-nutritional compounds in the grains that interfere with the absorption of nutrients.

Keywords: adzuki Bean, Nutritional Components, Germination, Bioactive Components

Management of brinjal fruit rot caused by *Phomopsis vexans*

Sheetal Dhariwal* and Pooja Sangwan

Department of Plant Pathology, CCS Haryana Agricultural University Hisar, Pin 125 004 (Haryana) INDIA

ABSTRACT

Eggplant (*Solanum melongena L.*) commonly known as brinjal belongs to the family Solanaceae. Brinjal is particularly grown in sub-tropical and tropical regions of the world. It is the most important vegetable in India and is described as “king of vegetables” due to its wide usage in Indian foods. The brinjal crop succumbs to various biotic and abiotic stresses at various stages of growth. There are several environmental, edaphic and plant factors which results in lower production and productivity in brinjal. It is attacked by many fungi, bacteria and viruses. Among various stresses, diseases are the prominent factor in decreasing the production in brinjal. The major diseases which reduces the yield in brinjal is *Phomopsis* fruit rot caused by *Phomopsis vexans*. The pathogen is seed-borne and produce large number of conidia which causes infection in brinjal. The devastating diseases such as phomopsis blight should be controlled effectively for increasing its marketability and consumption. The effective fungicides which shows highest average mycelial growth inhibition are carbendazim, propiconazole and hexaconazole among systemic fungicides. Among non-systemic fungicides, highest average mycelial growth inhibiting fungicides are mancozeb, propineb and chlorothalonil. Seed treatment with carboxin + thiram @0.2% and copper oxychloride @ 0.25% is very effective against *Phomopsis vexans*. An increasing consciousness about environmental pollution due to fungicides and development of fungicide resistance in pathogen population has challenged the plant pathologist to search for eco-friendly tools for *Phomopsis vexans* management. Seed treatment and spraying of *Trichoderma harzianum* and *Pseudomonas fluorescens* are very effective against *Phomopsis vexans*. Use of botanicals, bioagents are most commonly practiced now a days to avoid the problems created by the fungicides.

Role of AMMI and GGE biplot in development of new varieties in changing climatic conditions

Atul Loyal¹, Naval Kishore² S. K. Pahuja¹

¹*Department of Genetics & Plant Breeding, CCSHAU, Hisar, Haryana. (India) (125004),*

²*Hill Agricultural Research and Extension Centre, Bajaura, Kullu, HP-175125*

ABSTRACT

Barley is one of the major rabi crops of northern India. It is grown in irrigated as well as rainfed conditions. The present study was planned and conducted by keeping in view the rainfed conditions of Himachal Pradesh. 21 genotypes of barley were grown across five different locations viz., Malan, Berthin, Kangra, Bajaura and Katrain.

3rd International Conference on “Global Initiative in Agricultural, Forestry and Applied Sciences for Food Security, Environmental Safety and Sustainable Development (GIAFAS-2021)”

Each of them was representative of a different environment. The main purpose of the experiment was to check the stability of the genotypes and identify the stable and superior genotypes using AMMI and GGE biplot analysis. It was reported from the study that there was a significant difference in the performance of genotypes due to G×E interaction. Among the total variation environments explained the most of variation followed by genotypes and genotype × environment interaction (GEI). The ‘which won where’ pattern showed that no single genotype was found stable as well as high yielding for more than one trait. Although Genotype G8 (HBL 812) was found to be superior in terms of biological yield in all environments except Katrain. G8 (HBL 812) was considered as the best performing genotype amidst all environments. The study further indicated that during the developmental phase of a cultivar/variety more emphasis should be given to the environment. AMMI and GGE biplots can play a pivotal role in determining and partitioning the total component of variation into the environment, genotypic and G × E interaction.

Keywords: Barkey, AMMI, GGE biplot, Stability, G × E interaction, Environment

COMPARATIVE GENOMICS AND IT’S SIGNIFICANCE IN CROP IMPROVEMENT

Alka Soharu and Navdeep Kaur

Department of Genetics and Plant Breeding, CSK Himachal Pradesh Krishi Vishvavidyalaya, Palampur-176062

ABSTRACT

Comparative genomics is a branch of biology that compares the genomic characteristics of different animals. The DNA sequence, genes, gene order, regulatory sequences, and other genomic structural landmarks are examples of genomic characteristics. Whole or substantial portions of genomes arising from genome studies are compared in this branch of genomics to investigate basic biological similarities and differences, as well as evolutionary relationships between organisms. The major principle of comparative genomics is that common features of two organisms will often be encoded within the DNA that is evolutionarily conserved between them. As a result, comparative genomic techniques begin with some kind of genome sequence alignment, followed by a search for orthologous sequences (sequences that share a common ancestor) in the aligned genomes and a determination of how conserved such sequences are. On the basis of them, genome and molecular evolution can be predicted, which can then be applied to phenotypic evolution or population genetics.

This discipline has gotten increasingly sophisticated as a result of improvements in DNA sequencing technologies, particularly next-generation sequencing methods in the late 2000s, which made it possible to deal with several genomes in a single study. Comparative genomics has demonstrated that closely related organisms have a lot of things in common. It also revealed the tremendous diversity of gene architecture across evolutionary lineages. Art Delcent established the very first high-resolution whole genome comparison technique in 1998 for drought tolerance. Whole-genome sequencing and comparative characterization of two *Rhodospseudomonas palustris* plant-associated strains (PS3 and YSC3) revealed that regardless of the fact that these variants are phylogenetically similar, only strain PS3 can boost plant growth. This approach is not only effective, but it is also rapid. Identifying loci linked to agronomic performance in the past required multiple generations of carefully supervised breeding of parent strains, a time-consuming endeavour that is no longer essential for comparative genomic investigations.

Keywords: Comparative genomics, orthologous, next-generation sequencing, evolutionary lineages

Standardization, Mass production and evaluation of N-fixing and phosphate solubilising biofertilizers using indigenous bacterial strains from rice rhizosphere in Jammu district

Renu Gupta *

Division of Soil Science and Agriculture Chemistry, Faculty of Agriculture, SKUAST-Chatha

ABSTRACT

Biofertilizer is a substance which contains living microorganism, have no toxic effect on the soil and a boon towards organic agriculture. These are ready to use live formulates of beneficial microorganisms which on application to seed, root or soil mobilize the availability of nutrients by their biological activity in particular and help in building up the micro flora and in turn the soil health. The use of biofertilizer is low cost when compared to chemical fertilizer. They play the vital role by reducing the nutrient competition in crop, converting the fixed form of nutrient to available forms, enriching the soil nutrition and being eco-friendly in soil. An attempt was made to

3rd International Conference on “Global Initiative in Agricultural, Forestry and Applied Sciences for Food Security, Environmental Safety and Sustainable Development (GIAFAS-2021)”

produce bacterial biofertilizer from indigenous isolates of azotobacter, beizerinckia and PSB from rice rhizosphere in jammu district. These isolates screened are plant growth promoting bacteria which are gram negative (75%), gram positive (10%), both gram positive and gram negative (15%) mostly used as bio-fertilizers. Azotobacter and Beijerinckia are free living diazotroph reported to produce beneficial effect on crop yield through stimulation of rhizospheric microbes, modification of nutrient uptake and boosting nitrogen fixation. Also PSB are capable of solubilising insoluble inorganic phosphates and make them available for plant nutrition.

All isolates were grown in nutrient agar medium and were further subcultured for obtaining pure cultures of the bacteria. Specific medium were used for isolation of various nitrogen fixers and phosphate solubilizers. Initially the organism were isolated from the soil sample and confirmation was done using the biochemical test. When cell count reached to 10^8 - 10^9 cells/ml, the broth was used as inoculant. For easy handling, packing, storing and transportation, broth is mixed with an inert carrier material which contains sufficient amount of cells. In present study broth was mixed with FYM using 1% Activated charcoal and 1% CaCO_3 ratio over the carrier in such a way that 40% moisture was maintained throughout the course of study. After proper mixing carrier containing inoculant was left for 15 days and above formulated microbial inoculants were tested for cell count 10^8 - 10^9 cells/ml. The above formulated microbial inoculants was packed and stored and was studied for OD^{600} of 1 for consecutive 5 months. The cell count was maintained and followed increasing trend up-to 4 months after which it exhibited a slight decline in cell count. It is naturally produced bio-fertilizer and it does not have any negative effect on the soil or crops. The biofertilizer so produced was further evaluated and tested on rice varieties basmati-370 and 1121 along with organic manure. The application of biofertilizer along with organic manure exhibited significant difference as compared to sole application of biofertilizer and organic manure alone.

Keywords: Bio-fertilizer, Azotobacter, Beijerinckia, PSB, Mass production, Evaluation.

Backyard Poultry Management Practices in Tribal Area of Dungarpur District of Rajasthan

Budharam*, Hitesh Muwal, Vinod Bhatshwar*****

Department of Animal Production, Rajasthan College of Agriculture, MPUAT, Udaipur

Department of Dairy Science and Food Technology Institute of Agricultural Sciences Banaras Hindu University, Varanasi.

ABSTRACT

The current research was conducted on backyard poultry rearing system in tribal district Dungarpur, four tehsils of Dungarpur district *i.e.* Dungarpur, Bicchiwada, Aspur and Sagwara were selected for the study purpose. Three villages were selected from the each identified tehsil. 15 farmers from every village were randomly selected for a sample of 180 recipients. The examination revealed that all the selected farmers belong to tribe of Hindu religion and 51.11 per cent recipients live in joint families. The recipients were mostly having 4-6 members in their family (69.44%). The literacy rate of whole family was 62.62 per cent and all the farmers depend on agriculture plus animal husbandry profession and living in mixed type houses. Most of the farmers (46.67%) had 1-2 ha land followed by (45.00%) less than 1 ha land, poultry species predilection by the farmers was supreme (70.56%). Most of selected farmers (86.11%) nourished self-made feed to poultry twice in a day time and 86.11 per cent also provide mineral mixture and 75.00 per cent provide grit to poultry birds by using feeder made up of plastic (36.67%). Maximum of the farmers (75.56%) use personal masculine for breeding purpose. Criteria for selection of egg to hatching mostly (92.22%) depends on both egg size and shape. Average egg production was 680 per family. Average income by farming, animal husbandry and labour year⁻¹ was Rs. 138350.15 per respondent. Average 38.91 birds reared by each respondent and average 10.11 birds consumed and 28.81 birds sold by every respondent. The mean number of eggs produced per year per family was 680 and out of these 170 eggs was spent at homes while the 510 eggs was sold out cost. Benefits ratio per recipients was 1:1.95. Predators problems was the major constraints facilitating respondents.

Bioremediation of thiamethoxam contaminated soils by *Bacillus pumilus* isolated from soil

Rozy Rasool*, Balpreet Kaur Kang

Pesticide Residue Analysis Laboratory, Department of Entomology, Punjab Agricultural University, Ludhiana-141004, Punjab, India s

ABSTRACT

Bioremediation of thiamethoxam is a promising approach to degrade the pesticide from soil. Isolation and identification of soil microbes was conducted for bioremediation of thiamethoxam contaminated soils. Soil samples collected from different wheat growing fields in Punjab with extensive use of pesticide history served as a source of pesticide degrading microbes. Enrichment of microbial biomass obtained from thiamethoxam contaminated soil, in Dorn's broth containing thiamethoxam as sole source of carbon, resulted in growth of bacterium. The bacterium isolated was identified as *Bacillus pumilus*, on the basis of morphological characteristics, biochemical characteristics and 16S ribosomal DNA sequence homology. Clay loam soil samples were fortified with thiamethoxam @ 50, 100 and 150 mg kg⁻¹ along with 45×10⁷ microbe cells. Each treatment was replicated thrice and from each fortified (insecticide +microbes) sample, 15 g soil sample was taken at 3, 7, 14, 28, 35, 42 and 49 days after inoculation. The soil samples were evaluated for total thiamethoxam degradation using LC-MS/MS. Among metabolites, clothianidin was found to be the main metabolite followed by nitroguanidine and 1-methyl-3-nitroguanidine. N-desmethyl-thiamethoxam was not produced in any of the samples. Total thiamethoxam residues were not found to follow the first order kinetics. From the present study, we concluded that inoculation of *Bacillus pumilus* isolated from in situ contaminated soil could result in most effective bioremediation, thus, relieving soils from thiamethoxam residues.

Keywords: Thiamethoxam, Metabolite, *Bacillus*, Soil, Biodegradation

Removal of cadmium (II) ion from aqueous solution using *Melia azedarach* twig charcoal powder

Joat Singh¹, and Jatinder Kaur Katnoria^{1*}

Department of Botanical and Environmental Sciences, Guru Nanak Dev University, Amritsar-143005, Punjab, India

ABSTRACT

Past developments in science and technology have brought tremendous progress in industrialization but at the same time, it also led to the degradation of the air, soil and water quality throughout the world. The increasing pollution on account of heavy metals particularly in water ecosystems has become a major concern for human health as well as environmental quality. Due to their toxicity and insusceptibility to the environment, presence of heavy metals in drinking water has become an increasingly severe environmental concern during the last few decades. Different techniques of water remediation have come up as solution to treat wastewater. However, one of the best wastewater treatment technologies in the world has been identified as the biosorption process. Biosorption process, recognized as highly efficient and low-cost technique is the attractive alternative method for the removal of heavy metals from polluted water. In this study, the charcoal prepared from twigs of *Melia azedarach* was used as a biosorbent for the removal of cadmium ions from an aqueous solution. The batch experiment was performed to study the effects of pH, adsorbent dose, RPM, contact time, and temperature. The maximum removal of 91 % was achieved from cadmium (II) solution of 25 mg/L after 3 h of contact time, at pH 7, with 0.2g/100 ml of an adsorbent dose having a shaking speed of 180 rpm.

Keywords: Wastewater treatment, heavy metals pollution, toxicity, adsorption

Assessment of weed management practices on productivity and economics of Pigeonpea

Vinod Kumar, Ashok Kumar, Mukesh Kumar, Rita lal and Shashank Tyagi⁴

Krishi Vigyan Kendra, Munger, ⁴BAC, Sabour

ABSTRACT

The On-farm trial was conducted during *Kharif* season year 2018-19 and 2019-20 for "Assessment of weed management practices on productivity and economics of Pigeonpea" at farmers fields of Munger district. The On-farm trial was conducted in randomized block design with three technical options *viz.* pendimethalin @1.0 kg a.i./ha at pre-emergence and Imazethaypr @ 40 g a.i./ha at 20 days after sowing (post-emergence) and Imazethaypr @ 60 g a.i. /ha at 30 days after sowing (post-emergence) and farmers practice (one hand weeding at 20-25 days after sowing) and keeping with 08 farmers fields (replications). Application of Imazethaypr @40 g a.i./ha at 20 days after sowing (post-emergence) was recorded significantly lower population of total weeds (16 and 21 m⁻²) in pigeonpea crop over farmers practice (69 and 76 m⁻²) and pendimethalin @1.0 kg a.i./ha at pre-emergence (33 and 38 m⁻²) at 2-3 days after sowing and Imazethaypr @ 60 g a.i./ha at 30 days after sowing post-emergence (23 and 26 m⁻²) in both the seasons of trials. Application of Imazethaypr @40 g a.i./ ha at 20 days after sowing (post-emergence) was recorded significantly higher grain yield (16.51 and 14.6 q ha⁻¹), gross returns (Rs. 90805 and 78925/ha), net return

3rd International Conference on “Global Initiative in Agricultural, Forestry and Applied Sciences for Food Security, Environmental Safety and Sustainable Development (GIAFAS-2021)”

(Rs. 71505 and 59125/ ha) and B:C ratio (3.71 and 3.23) of pigeonpea over farmers practice and pendimethalin @1.0 kg a.i./ha at pre-emergence during both years.

CHILDCARE AMONG AGRICULTURAL LABOURER HOUSEHOLDS - PROBLEMS AND STRATEGIES TO OVERCOME THEM

Dr. (Mrs.) Dibyaprava Pradhan

HDFS, College of Home Science, Orissa University of Agriculture and Technology, Bhubaneswar – 751003, Odisha, India

(For Poster Presentation)

ABSTRACT

The teeming millions of the world who are engaged in farming to provide all the living beings with essential commodities to eat and live are the poor agriculturists. The worst sufferers among the agriculturists are the agriculture labourers. Despite their hard labour they lead a poor and wretched life. Under these conditions, it becomes somewhat impossible for them to think of the proper development of their children. Consequently, the children meet the untimely death and those who survive live a life of poverty, hunger, disease, ignorance, hatred and exploitation. The childcare practices prevalent among the poverty-stricken agricultural labourers are not soothing and sufficient enough to help the most vulnerable section of the society. There is enough of scope to do for their children and their families starting from conception and also during very early childhood years where the foundation can best be set to ensure that children are physically healthy, mentally alert, emotionally secure, socially competent and intellectually able to learn.

A study was conducted on 160 agricultural labourer households having at least one child in the age group of 1-5 years from 8 villages randomly selected from four blocks, which were purposively selected from four districts of Orissa.

Only 25 (15.63 %) out of 160 children were found to be totally normal based on all three parameters (ht/ age, wt/age and wt/ht). The rest 84.37 % had different degrees of malnutrition. Majority (68.13 %) among malnourished children were in the present and past underfed group (low wt/age, low ht/ age and low wt/ ht) followed by 6.88 % in the presently normal fed with past history of malnutrition group (normal wt/ age, low ht/ age and normal wt/ ht). The rest three groups i.e. presently malnourished (low wt/age, normal ht/age & normal wt/ht), presently underfed with past history of malnutrition (low wt/age, low ht/age & normal wt/ht) and presently underfed (low wt/age, normal ht/age & low wt/ht) comprised of 3.13 % children each.

Prolonged exclusive breast feeding, delayed weaning, ignorance of nutritional need of children and high morbidity due to diarrhoea were probably some of the causative factors. It is also found out while analyzing their background that they were economically and educationally poor, lived-in unhygienic environment and had poor inner resource capability. In addition to this, lack of time and mind to look after the child, suffering from various occupational and health hazards were probably some of the other causative factors. Most of the labour families had no homestead land for kitchen gardening and had limited adoption of recommended childcare practices.

Some measures must be taken to elevate their standard of living and improve their life style. In fact, some steps had already been taken by the government and private agencies in this respect. A well-planned strategy has been formulated for the above purpose basing on the perceived problems of the agricultural labourer households for more parental involvement and better childcare in order to obtain proper growth and development of their children.

Influence of PGRs and planting geometry on growth, yield & quality of gladiolus (*G. grandifloras L.*)

Khiromani Nag¹ and Abhishek Singh²

Deptt. of Horticulture, FAST, AKSU Satna (M.P.) 485001

ABSTRACT

Experiment compromised of three level of Gibberellic acid such as 50ppm, 100ppm and 150ppm and three spacing's viz. 30x15cm (S₁), 30x20cm (S₂) and 30x25cm (S₃). Experiment was laid out in RBD (with factorial concept) with three replications. The results of the experiment showed application of GA₃ and use of spacing's had significantly. Influence on the most parameters such as sprouting percentage, height of plant, number of leaves per plant, Length of spikes, days to opening of 1st florets, vase life of spikes, number of corms per plant and weight of corms per plant

3rd International Conference on “Global Initiative in Agricultural, Forestry and Applied Sciences for Food Security, Environmental Safety and Sustainable Development (GIAFAS-2021)”

at the @ 150ppm GA₃. Experiment compromised of three spacing's viz. 30x15cm (S₁), 30x20cm (S₂) and 30x25cm (S₃) had significantly. Increase on the most parameters such as height of plant, corms per plant and weight of corms per plant was the higher yield on wider spacing's 30x25cm (S₃).

Keywords: Gladiolus, GA₃, geometry, growth, yield, spikes and spikes

Improving floral attributes in orchid through genetic engineering

Khiromani Nag¹, Gloriya Smitta Kispotta² and Jogendra Kumar³

^{1,2}Deptt. of FLA, CoA, IGKV, Raipur, 492012 - (C.G.)

³AKS University, Satna (M.P.) 485001

ABSTRACT

Genetic engineering is the technology for modifying the genetic information in a plant, human or animal in order to produce some desired trait or characteristics. Father of genetic engineering is Paul Berg. He was the first who developed recombinant DNA technology. Different methods are available to achieve genetic transformation of plants *i.e.* the delivery of the foreign DNA into the host plant. These are divided into two main group's *i.e.* Indirect methods in this case vector is needed for insertion of the foreign DNA into the host genome. And direct methods are vector independent. The DNA is directly inserted into the host genome. Vector mediated gene transfer, *Agro bacterium* mediated, viral vector, agro infection, direct gene transfer, biolistic/particle gun transfer, microinjection, macro injection, electro oration, liposome mediated, polyethylene glycol mediated, silicon carbide fiber incubation of seed with DNA, Pollen tube pathway, indirect methods or vector mediated gene transfer, Orchids, one of the most fascinating creations of the nature are one of the most widely distributed groups of flowering plants on the earth. Orchid is one of the oldest known and world largest family of flowering plants comprising of over 800 genera and between 25,000 - 35,000 species. The parameters *viz.*, importance, orchid based products used in worldwide nation, genetic engineering for orchid & their spp., floral trait modifications, improvement of flower, plant pigments, flower color, gene involve in different orchid spp. genetic engineering for white flower, induction of early flowering, fragrance and shelf life enhancement etc.

Key words: Orchid, floral attributes and genetic engineering

BIOINFORMATICS IN AGRICULTURE

G. Prasanna and Dr. L. Krishna

Dept. of Genetics and Plant Breeding, College of Agriculture, Rajendranagar, Hyderabad, 500030.

ABSTRACT

The National center for Biotechnology information (NCBI, 2001) defines bioinformatics as the field of science in which biology, computer science and information technology merge into a single discipline. It deals with computational management and analysis of biological information (genes, genomes, protein, medical information, robots and artificial intelligence). It also deals with development of new algorithms and statistics with which to assess relationships among members of large data sets. The ultimate goal of bioinformatics is to uncover the wealth of biological information hidden in the mass of sequence, structure, literature and other biological data. Software tools for bioinformatics range from simple command-line tools to more complex graphical programs. The computational biological tools BLAST (Basic Local Alignment Search Tool) an algorithm for determining the similarity of arbitrary sequences against other sequences. It is used for identifying species locating domains establishing phylogeny DNA mapping comparison. Applications of bioinformatics in Agriculture includes insect resistance genes from *Bacillus thuringiensis* that can control a number of serious pests have been successfully transferred to cotton, maize and potatoes, development of drought resistance varieties in developing cereal varieties that have a greater tolerance for soil alkalinity, free aluminium and iron toxicities, improve nutritional levels scientists have recently succeeded in transferring genes into rice to increase vitamin A, iron and other micronutrients, crop improvement genome sequences of several important plant species. Databases exclusively for plants includes GrainGene (Triticeae), Gramene (Rice), TAIR (Arabidopsis), AtEnsEMBL (Arabidopsis) and maize GDB (Maize).

Barbara McClintock's Concept on mutable loci in maize : A Review

Pooja Kanwar Shekhawat^{*}, Dr M. L. Jakhar¹, Anita², Nikki Kumari³

Department of Plant Breeding and Genetics, S.K.N.Agriculture University, Jobner, Jaipur 303328 (Rajasthan)

Department of Genetics, IARI, New Delhi

ABSTRACT

The most profound genetic discoveries and innovations have been made with the help of various model organisms. Among them one such model is *Zea mays*, particularly those plants that produced variable colored kernels. As each kernel of maize is an embryo produced from an individual fertilization, hundreds of offspring can be scored on a single ear, making maize an ideal organism for genetic analysis. Hence, maize proved to be the perfect organism for the study of transposable elements (TEs), also known as "jumping genes," which were discovered during the middle part of the twentieth century by American scientist Barbara McClintock. A transposable element is a DNA sequence that can change its position within a genome, creating or reversing mutations and altering the cell's genetic identity and genome size. Transposition often results in duplication of the same genetic material as well as play important role in genome function and evolution. Initially work on transposon was started by R A Emerson that occurrence of purple or brown spots on colourless maize kernels and hypothesized that spots were due to unstable mutation on chromosomes. However, he couldn't explain why or how this occurred. McClintock was experimenting with maize plants that had broken chromosomes. McClintock bred females that were homozygous for *C* and *bz* and that lacked *Ds* with males that were homozygous for *C'*, *Bz*, and *Ds* to yield heterozygotes with an aleurone layer that had the genotype *C'CCBzbzbz—Ds*. Because of the presence of the dominant inhibitor allele *C'*, the offspring kernels were expected to be colorless. However, she also observed many kernels with colorless backgrounds and varying amounts of dark brown spots or streaks, and concluded that individual cells in those kernels had lost their *C'* and *Bz* alleles because of a chromosomal break at the *Ds* locus which was also dependent on occurrence of mutation in stage of seed development. Additional experiments with the *Ds* locus revealed that chromosome breakage at this locus required a second dominant locus, which could also initiate its own transposition. McClintock named this locus Activator (*Ac*) and found that *Ds* chromosome breakage could be activated by an *Ac* element at a different site or even on a different chromosome. McClintock's 1950 PNAS Classic Article "The origin and behavior of mutable loci in maize" summarized years of experimental data in support of *Ds* and *Ac* transposition where she noted that *Ac* and *Ds* could transpose, that their insertion could lead to unstable mutations, and that the movement of transposons from the mutated loci could restore a gene's function. McClintock followed up her Classic Article with a talk at the 1951 Cold Spring Harbor Symposium describing her discovery of transposition but scientist didn't understand it and didn't take it seriously because in previous discoveries was shown that genes were at fixed position on chromosome in linear order. Her work was largely dismissed and ignored until the late 1960s–1970s when, after TEs were found in bacteria, it was rediscovered. Nina Fedoroff, Molecular Biologist (met with McClintock in 1978) with her students unraveled the molecular details of how these mobile DNA sequences move and how the plants exert epigenetic control of their movement and finally they succeeded in cloning them. Finally, McClintock's discovery was recognized and was awarded a Nobel Prize in Physiology or Medicine in 1983 for her discovery of TEs, more than thirty years after her initial research. Beyond her discovery of TEs, Barbara McClintock was the first scientist to speculate idea about the basic concept of heritable changes in gene expression (Epigenetic) that are not caused by changes to DNA sequences. McClintock proposed this theory before the molecular structure of DNA and more than 40 years before the concept of epigenetics was formally studied.

Keywords: Transposons, Epigenetics, Jumping Genes, Mutation, Mutable loci

Ergonomical evaluation of harvesting by serrated sickle

Amita Gautam^a and S.V. Jogdand^b

Swami Vivekanand CAET & RS, FAE, IGKV, Raipur (C.G.), 492012, India

ABSTRACT

Rice harvesting is a major task performed by farmers and both male and female workers constitute a major task force in agricultural operation in India. Therefore, it becomes necessary to study the ergonomics of operators involved in harvesting to suggest modifications for further reduction of drudgery. Ergonomical parameter like working heart rate (HR), oxygen consumption rate (OCR), energy expenditure rate (EER), body parts discomfort score, and overall discomfort rate (ODR) were evaluated. The use of female and male anthropometrics data can help in the proper designing of new equipment and modifying the existing machine. Nineteen body dimension including weight of the subjects useful in agricultural equipment design were identified and measured from 3 female and 3 male agricultural workers of the region. Mean, Standard deviation standard error, 5th and 95th percentile, range was estimated for each body dimension. These body dimensions were correlated with stature. The selected subjects were used in field trials for ergonomical and mechanical evaluation with selected sickles for harvesting operation.

3rd International Conference on “Global Initiative in Agricultural, Forestry and Applied Sciences for Food Security, Environmental Safety and Sustainable Development (GIAFAS-2021)”

Physiological cost of work and body discomfort were evaluated. The mean values of stature, age and weight for female agricultural workers were 148.66 cm, 34 year and 40.66 kg and for male workers 158.34 cm, 36.66 year, 59.76 kg. Linear relationship was found between most of the body measurements and stature for agricultural workers of the region.

Keywords: Harvesting, heart rate, drudgery, oxygen consumption rate, serrated sickle, traditional sickle.

Carbon sequestration potential of *Grewia oppositifolia* based traditional Agroforestry system in Garhwal Himalayan region of India

Naveen Tariyal^{1*}, Arvind Bijalwan¹, Bhupendra Singh Butola¹, Sumit Chaudhary², Aalok G. Yewale³ and Shikha³

¹ VCSG College of Forestry Ranichauri Tehri Garhwal Uttarakhand, India

² College of Hill Agriculture, Chirbatiya Rudraprayag Uttarakhand, India

³ Krishi Vigyan Kendra Ranichauri Tehri Garhwal Uttarakhand, India

ABSTRACT

Forests have been recognized as a significant carbon sink, and their role in lowering CO₂ emissions and improving carbon sinks is widely accepted. Agroforestry provides an exclusive opportunity to combine the objectives of climate change adaptation and mitigation. It can enhance the resilience of the system for coping with the adverse impacts of climate change. The present study on carbon sequestration potential was carried out in a *Grewia oppositifolia* based traditional agroforestry system in six villages at two elevations, lower elevation (1000-1400m AMSL) and higher elevation (1400– 1800m AMSL) of Tehri Garhwal district of Uttarakhand. The results were estimated for population structure percent, Growing stock, Above and below-ground biomass and total carbon sequestration. The outcome of the revealed that the population structure percent varied from 63.50% to 85.18% which recorded maximum in 10-20cm diameter class of the tree at both the elevations. Growing stock and biomass density was found maximum at lower elevation as compared to a higher elevation. The average carbon stock at lower and higher elevation was 23.29 mg ha⁻¹ and 18.70 mg ha⁻¹ respectively. The carbon sequestration potential of *Grewia oppositifolia* based traditional agroforestry system at lower elevation was higher compare to higher elevation. The total biomass density and total carbon density were estimated highest at 10-20 cm diameter class at both the elevation. Therefore, *Grewia oppositifolia* based traditional Agroforestry systems have the greatest potential to provide significant mitigation alternatives to sequester the carbon.

Keywords: Agroforestry system, carbon sequestration potential, elevation.

Identifying of Resistant and Susceptibility of Manipur Paddy Cultivars to Angoumois Grain Moth, *Sitotroga cerealella* (Olivier).

Nisanam Nagaraju¹, Nilima Karam^{1*}, K.I. Singh¹, Gulappa Chandra Sekar¹, N. Gopimohan Singh²

¹ Department of Entomology, College of Agriculture, Central Agricultural University, Imphal.

² Department of Agricultural Statistics, College of Agriculture, Central Agricultural University, Impha

ABSTRACT

Studies were undertaken on resistance and susceptibility response of five popular and released varieties of paddy in Manipur against Angoumois grain moth, *Sitotroga cerealella* (Olivier.) under controlled laboratory conditions at Central Agricultural University, Imphal, Manipur. The varieties were CAU R1, CAU R2, RC Maniphou - 9, Drum phou and Tolen phou. The results were based on percent seed damage and percent weight loss of paddy seeds after completing one lifecycle of the pest inside tested glass jars. It was found that none of the varieties was completely resistant to infestation by *S. cerelella*. The variety with maximum seed damage and seed weight loss was considered as the most susceptible variety. The variety CAU R1 recorded highest seed damage of 21.88% and weight loss of 11.70% which was statistically at par with Drum phou which showed mean seed damage of 19.38% and percent weight loss of 11.10%. Partial tolerance could be seen in variety RC Maniphou-9 with seed damage of 13.75% and weight loss of 7.86% recording the lowest damage by *S. cerelella* among the varieties evaluated. The overall preference or susceptibility response by *S. cerealella* on tested paddy varieties can be summarized in the following order CAUR1 ≥ Drum phou ≥ CAUR2 ≥ Tolen phou ≥ RC Maniphou.

Keywords: Paddy, Angoumois grain moth (*S.cerealella*), Resistance, Susceptibility.

Design of separator for tractor drawn onion digger

Amita Gautam^a, S.V. Jogdand^b, R.K. Naik^c, Pushpraj Diwan^a and Smita Gautam^d

PI-AICRP-FIM, Swami Vivekanand CAET & RS, IGKV, Raipur (C.G.), 492012, India

D.B. Degree Girls College, Raipur (C.G.), 492001, India

ABSTRACT

Harvesting is one of the costly, labour intensive and time consuming operation in onion cultivation. Due to delayed in harvesting of onion and other factors, damaged occurred about 59% in Madhya Pradesh, 18% in Karnataka and 2% in Andhra Pradesh that reflect the low market arrival of onion at July-Nov 2019. Generally onion harvesting is performed manually by small and medium farmers. So it is necessary to design a mechanical digger for onion crop to overcome the problems. A good onion digger required a suitable separator unit to separate onion from the soil. Separator unit is attached just behind the digging blade in onion digger. To design a suitable separator various engineering properties of matured onion bulb is determined like geometric mean diameter, sphericity, aspect ratio, shape index, bulk density, true density, angle of repose and coefficient of friction. In first step the rotary power required to operate the separator was found as 6.0 kW. On the basis of agronomical parameters of onion crop, engineering properties of onion bulb and soil properties of onion field the width and length of the separator was decided. The speed of the separator and inclination angle was selected by laboratory testing based on the separation efficiency of the separator, for that three different separator velocities (0.5, 1.0 and 1.5 m s⁻¹) and five different inclination angle of separator (10, 15, 20, 25 and 30°) from horizontal was analyzed statistically with the help of randomized block design. Significant difference in separation efficiency was observed due to different inclination angle of separator, which was observed more than 95% at separator angle less than 15° from the horizontal.

Keywords: Onion digger, engineering properties of onion bulb, agronomical properties of onion, design of separator, separation efficiency.

Development of two row power weeder for wet land paddy and comparative evaluation with existing weeding methods

Pushpraj Diwan^a, Prabhat Kumar Guru^b, Rajesh Kumar Naik^c, Nenavath Manikyam^a and Amita Gautam^a

PI-AICRP-FIM, Swami Vivekanand CAET & RS, IGKV, Raipur (C.G.)

ICAR-NRRI, Cuttack, Odisha

ABSTRACT

Farm mechanization is helpful for achieving the higher production. There is a linear relationship between availability of farm power and farm yield and Government has decided to enhance farm power availability from 2.02 kW per ha (2016-17) to 4.0 kW per ha by the end of 2030 to cope up with increasing demand for food grains. In mechanization point of view a two row power weeder was developed for rice in the agricultural engineering workshop of ICAR-NRRI, Cuttack (Odisha). Comparative evaluation was performed by taking five different weeding methods, which were finger weeder (T₁), star cono weeder (T₂), developed two row power weeder (T₃), single row power weeder (T₄) and traditional hand weeding (T₅). Weeding efficiency was best in traditional hand weeding (T₅) and plant damage was also less in this method. Average weeding efficiency and plant damage of developed two row power weeder at 40 DAT was found to be 68.48% and 2.99%, respectively. Operational cost of power weeder (T₃) was found ₹ 1239/- per hectare, which was 55.55%, 28.91% and 82.22% percent less than other weeding methods T₁, T₂ and T₅ respectively and 29.45% greater than the single row power weeder (T₄).

Keywords: Mechanical weeding, Weeding efficiency, plant damage, field capacity, cost of weeding.

Heavy Metal Analysis and Health Risk Assessment of Soil under Rice Cultivation of Batala Region of Punjab (India)

Neeru Bala¹, Yogesh B. Pakade² and Jatinder Kaur Katnoria^{1*}

¹Department of Botanical and Environmental Sciences, Guru Nanak Dev University, Amritsar-143005, Punjab, India

²CSIR-National Environmental Engineering Research Institute, Nagpur

ABSTRACT

Soil is a complex, dynamic and heterogeneous system that supports life on earth by acting as a habitat for plants and animals. The Physico-chemical characteristics of soil are known to vary with location, time and land use. However, increased use of agrochemicals, contaminated irrigation water, dumping of solid wastes and various other anthropogenic activities enhanced inputs of various pollutants including heavy metals into soil over past decades. Soil with elevated levels of heavy metals leads to their excessive uptake by plants which causes higher accumulation in different plant tissues leading to phytotoxic effects. Metals like chromium, copper and cobalt at concentrations higher than the permissible levels can induce metabolic abnormalities in humans. Considering the same, the present study was planned to determine heavy metal contents in soil under rice cultivation in the Batala region of Punjab, India. Heavy metal contents in rice samples (husk and flour) were analyzed to explore the potential human health risks. Also, the soil to metal accumulation factor (bioaccumulation factor) and Hazard quotient (HQ) were evaluated to determine whether they pose possible health risk to humans. Five sites viz., Bhagowal, Doburji, Said Mubarak, Chitt and Natt of Batala region were selected for collection of soil and rice samples were from the agricultural fields. The samples were analyzed for heavy metals such as cadmium (Cd), cobalt (Co), chromium (Cr), copper (Cu), iron (Fe), lead (Pb), and zinc (Zn) using Inductively Coupled Plasma-Mass Spectroscopy (ICP-MS). The mean content of different heavy metals (mg/kg) analyzed in soil samples were found to be in the range of Cd (0.08 - 4.53), Cr (0.09 - 243.825), Co (1.655 - 7.145), Cu (0.93 - 12.3), Zn (1.49 - 341.8) and Pb (0.02 - 3.335) while in rice husk samples, it was observed as Cd (0.02 - 0.025), Cr (0.275 - 7.13), Cu (3.17 - 4.82), Zn (10.97 - 25.16) and Pb (0.415 - 8.55). All studied metals viz., Cd, Cr, Co, and Pb were found to be below the detection limit (BDL) in rice samples except Cu (2 - 3.174) and Zn (0.55 - 8.305). Among different rice husk samples, the bioaccumulation factor for heavy metals was found to be in the order as Co > Pb > Cu > Zn > Cr > Co whereas in the case of for rice was observed to be less than 1. Health quotient index (HQI) results revealed that the value for metal intakes by humans (male adult, female, adults, and children) was less than 1 indicating low risk and more than 1 as high risk.

Keywords: Inductively Coupled Plasma-Mass Spectroscopy, heavy metal contamination, bioaccumulation factor, health risk, environmental pollution

Benefits Perceived by the Students regarding E-learning during COVID-19 Pandemic

Rupanshi Yadav¹ and Prakash Panwar²

Department of Extension Education and Communication Management, College of Community and Applied Sciences, Maharana Pratap University of Agriculture and Technology, Udaipur-313001, Rajasthan

ABSTRACT

Background: Many countries ordered closure of all educational institutes due to COVID-19, but many institutes started on-line classes looking to future of the students. Maharana Pratap University of Agriculture and Technology also started on- line classes for the students. The sample was selected from all the six constituent colleges of MPUAT which included College of Community and Applied Sciences, College of Technology and Engineering, College of Dairy and Food Technology, College of Fisheries, Rajasthan College of Agriculture and College of Agriculture, Bhilwara. A list of enrolled students of second year and third year of Undergraduate degree program was procured from each constituent college. From the list, a sample of 50 students was selected randomly from each college. Thus the total sample of study comprised of 300 students. An online survey was conducted to collect information regarding benefits perceived by the students regarding e-learning during covid-19 pandemic from the students. A link was generated for the developed questionnaire and was sent to the students through Whatsapp and e-mail. Frequency, percentage and mean per cent score were used for analysing the data statistically. On the basis of the data obtained it was concluded that a flexible schedule and convenience (MPS 81.88) was found to be the major benefits perceived by the respondents in the e-learning followed by favourable for people with restricted mobility (MPS 81.11) and it also helps in an easy and quick share of educational material. A number of the respondents also believed that e-learning is helpful in saving time and money and in increasing general awareness of the respondents. Some of the respondents also believed that e-learning makes the attendance easy with MPS of 78.11. Less than half of the respondents (47.33%) believed that more time left for hobbies or for finding a job and 45.66 per cent believes in e-learning aids in the preparation of the students to globally communicate with MPS of 77.33 and 77.22 respectively. Respondents found that e-learning promotes active and independent learning, helpful in improving technical skills and cheaper than traditional with MPS of 76.66, 76.11 and 76.11 respectively. E-learning also helpful in preparing notes etc.

Effect of different cereals grain extract media on mycelial growth of *Pleurotus* spp. (*P. Sapidus* and *P. Flabellatus*)

Sandeep Kumar^{1*}, Gopal Singh², Ramji Singh², Popin Kumar² and Rajendra Prasad²

¹School of Agriculture, Uttarakhand University, Dehradun-248007 (U.K.)

²Department of Plant Pathology, S. V. P. University of Agriculture & Technology, Meerut, U. P. (India)-250110.

ABSTRACT

Present investigation pertains to study the impact of different culture media, on the mycelial growth and dry weight of *Pleurotus* spp. The study was conducted at Mushroom Laboratory Department Plant Pathology, S. V. P. University of Agriculture and Technology, Meerut, UP, India. In my research on effect of grains against *Pleurotus* spp. were conducted in seven treatments with four replications. All extracts were founded more or less mycelial growth of *Pleurotus* spp. the observation was recorded after nine days maximum radial growth (90.00 mm) in both species (*P. sapidus* and *P. flabellatus*) of was observed in Barley extract media. The maximum growth rate of mycelium (10.00 mm/day) of *P. sapidus* and *P. flabellatus* was recorded in barley extract agar. Maximum dry mycelium weight (7.98 mg/100ml & 8.35 mg/100ml) of *P. sapidus* and *P. flabellatus* was observed in barley extract broth respectively.

Keywords: Cereals, Media, *Pleurotus*, Mycelia and Dry weight.

Green synthesis of thiophene-2-carboxaldehyde azomethines and their antifungal evaluation

Sukhmanpreet kaur¹, Sunita sharma², Tanvi sahani¹, Diksha verma¹, Amanpreet kaur¹

¹Department of chemistry, Punjab Agricultural University, Ludhiana, Punjab, India, 141004

²Department of Plant breeding and genetics, Punjab Agricultural University, Ludhiana 141004

ABSTRACT

Globally 140 countries are main producers of citrus with annual production of more than 120 MT. After the consumption of fruit, a peel is left behind which is annoyance to the environment as solid waste. Organic chemistry involved the use of hazardous chemicals, solvents and catalysts. Kinnow (citrus fruit) peel contains ascorbic acid, pectin, lignin, limonen, and phytochemicals exhibiting different biological properties. So to avoid the use of toxic solvents present study deals with the clean synthesis of benzylidenes using kinnow peel extract as biocatalyst. Aromatic aldehyde namely thiophene-2-carboxaldehyde was condensed with different substituted amines 2,4-dinitrophenyl hydrazine, phenylhydrazine, hydrazine hydrate, 3-amino-1,2,4-triazole and thiosemicarbazide by conventional, microwave irradiation and grindstone methods. Characterization of the synthesized benzylidenes was done by UV, FT-IR and ¹H NMR. All the synthesized Schiff bases were screened for their fungitoxicity against *Macrophomina phaseolena*, *Rhizoctonia solani* and *Fusarium verticillioides*. None of the compound was more effective at standard carbendazim 50 WP. This work may be an exemplary way of green engineering to use the waste as resource for environmental sustainability.

Effect of different carrier agents on freeze dried button mushroom: a review

Rafeeya Shams*, Jagmohan Singh

Division of Food Science and Technology, Sher-e Kashmir University of Agricultural Sciences and Technology-Jammu

ABSTRACT

Mushrooms are a good source of protein, minerals, vitamins, and antioxidants along with numerous medicinal properties. Mushrooms are soft textured, highly perishable but are susceptible to microbial attack due to high level of moisture content. Drying of mushrooms is essential to carry out to reduce water activity. As mushrooms are very sensitive to temperature, choosing the right drying method can be the key for a successful operation. The preservation of aroma is essential for accessing quality of processed food products, and in particular for the case of mushrooms, which are very much used for culinary preparations because of their unique aroma. Freeze-drying has been identified as an effective method for drying of products with minimal deterioration to available food nutrients. Powder products produced from fruits like mushroom may present problems such as high hygroscopicity and caking due to the presence of low molecular weight sugars and acids with a low glass transition temperature. Thus, the use of carrier agents can result in powders with different thermal and microstructural properties, making easier the

drying process and reducing the hygroscopicity of the dehydrated product. Carrier agents such as maltodextrin and soy protein isolate (SPI) when introduced into the feed solution, influence the properties and stability of the powder and exhibit comparable or even better encapsulating efficiency, and higher stability against oxidation.

Keywords: Freeze drying, button mushroom, texture, shelf life.

meta-Topolin mediated in vitro regeneration of *Crinum* species

Swati Chahal and Harmeet Kaur

Lovely Professional University, Phagwara, Punjab

ABSTRACT

Crinum species exhibit diverse medicinal properties such as antioxidant, antimicrobial, antimalarial, antiviral, anti-inflammatory, anti-tumor, anti-diabetic, and immune-stimulating due to the presence of pharmacologically active alkaloids. *Crinum* species are known to be the richest source of a secondary metabolites line galanthamine, lycorine, tazatine etc. Galanthamine is well known for its acetylcholinesterase inhibiting properties and is used in modern medicine for the treatment of Alzheimer’s disease, sold in the market as Razadyne. Only 13 *Crinum* species are found in India and have questionable existence since some are found in very less numbers and are considered as critically endangered, therefore, *in situ* conservation of this plant species is of concern. Hence, the conservation and sustainable development of *Crinum* species and its secondary metabolites can only be assured by *ex situ* methods. *In vitro* propagation methods have proved to be effective in overcoming problems like, the dwindling of the population and have provided just solutions for the conservation and rapid multiplication of the plant species. But very few studies have been done on Indian *Crinum* species when it comes to the *in vitro* propagation. Hence, a new micropropagation protocol has been developed using an aromatic cytokinin meta-topolin. *In vitro* regeneration of multiple shoots and development of somatic embryos has been attempted by using various concentrations of both the cytokinins on MS media. The effect of mT on shoot regeneration was significant as compared to BAP. There is only one published paper regarding different *Crinum* species hence, these findings could be helpful in developing new protocols for mass propagation of species on the brink of extinction and for the enhancement of secondary metabolite using *in vitro* techniques.

Abbreviations

GAL – Galanthamine

MS – Murashige and Skoog

BAP – 6-benzylaminopurine

mT - 6-[3-hydroxybenzylamino] purine

The use of gunny waste fiber as complement in handmade paper production for a sustainable environment

Shobha Huilgol and Veena S Jadhav

College of Community Science, Department of Family Resource Management, University of Agricultural Sciences, Dharwad-580005

ABSTRACT

The concern for the environment is increasing day by day that make the people more interested in environment-friendly and sustainable products. The natural fibers are scientifically considered as recyclable, bio-degradable and ultimately eco-friendly in nature. This paper highlights the tremendous possibilities for handmade paper making in India, which with its eco-friendly and environmentally cleaner production technology will be an appropriate sustainable production system. Therefore the experimental research study was carried out on standardization of recycling and reuse of waste jute gunny and trimmed cotton (Hosiery) waste were used for production of papers. Physical parameters of the handmade papers were tested by using TAPPI standards methods. The objective of the study was to develop a low cost method for handmade paper production with use of gunny waste. In this study jute gunny and cotton waste were used for production of handmade paper in different ratios such as 100% Cotton, 100% Jute, 50% Cotton and 50% Jute gunny, followed by in the ration of 75:25 and 25:75 percent of Cotton and Jute gunny respectively. It was found that, the effect of blend ratio of cotton and jute on breaking length (km) was more in hand sheet with pure cotton (8.50-9.5 km) and less in hand with pure jute for hand sheet (1.28-9.50 km). In case of blended hand sheets, the breaking length (km) of jute: cotton 25/75 ranged from 7.48-8.22 km followed by

3rd International Conference on “Global Initiative in Agricultural, Forestry and Applied Sciences for Food Security, Environmental Safety and Sustainable Development (GIAFAS-2021)”

jute:cotton 50/50 ranged from 5.40-5.7 and jute:cotton 75/25 ranges 2.46- 2.90. It is also pointed that this method is very cost effective. On the basis of its production cost estimation; this method of handmade paper production requires low investment than the conventional paper making process and it has a lot of environmental benefits

Keywords: Cotton hosiery waste, Jute gunny, Handmade paper, and paper properties

Studies of Pusa Hydrogel application on yield and productivity of Wheat under limited irrigation conditions in Nimar Region of Madhya Pradesh

Y.K.Shukla and Rashmi Shukla

Krishi Vigyan Kendra, Khandwa RVSKVV-450001 (Madhya Pradesh)

ABSTRACT

Farmers in the Nimar regions of Madhya Pradesh generally facing water scarcity during Rabi season rain fed and have very limited scope for irrigation. Water scarcity is a major constraint for crop production in these areas. This problem exacerbates further during the *Rabi* season where vagaries of winter rain result in complete crop failure. This study was conducted in the Chaigoan Makhan Block of Khandwa district in Namar Region on the farmer's field in the year 2019-20 study the impact of hydrogel on yield and productivity of wheat in Rabi season. Hydrogel is a hydrophilic polymer having high water holding capacity and can provide water to crops during moisture stress. Hydrogel was applied in the field in *Rabi* wheat with two broad treatments, i.e. with hydrogel (WH) and without hydrogel (WHO). Each treatment was replicated ten times, i.e. ten demonstrations were laid out in the field conditions. Hydrogel was applied at the rate of 2.5 kg ha⁻¹ and observations related to various plant growth parameters and yields were recorded. The effective tillers in hydrogel plots increased by 13% compared to the non-hydrogel treated plots. The significantly improved due to hydrogel application. The total yield as well as grain yield increased significantly after hydrogel amendment. The improved performance of wheat upon hydrogel application was evident in the field. This technology could be promising in terms of productivity improvement of crops grown under limited source of irrigation and in combating the moisture stress in agriculture.

Keywords: Hydrogel, Demonstrations, limited irrigation wheat, yield.

Evaluation of phytopharmacological attributes and important secondary metabolites from *Tridax procumbens* L.

Aditi Arya, Sonia Goel¹ and Sapna Grewal²

Department of Biotechnology, Deenbandhu Chhotu Ram University of Science and Technology, Murthal (Haryana)

¹*Faculty of Agricultural Sciences, SGT University Gurugram (Haryana)*

²*Department of Bio and Nanotechnology, Guru Jambheshwar University of Science and Technology, Hisar (Haryana)*

ABSTRACT

Natural care and remedies from medicinal plants for treatment of various diseases have been practiced since ancient times which have certainly proved as safe and effective. Many plant species have been used in folklore medicine for the treatment of various ailments. Phytoconstituents from medicinal plants are important in pharmaceutical industry for preparation of therapeutic agents and drug development. The journey for the development of medicines starts with the precise identification of active compounds i.e., secondary metabolites, detailed biological assays, their pharmacological attributes and dosage formulations followed by clinical analysis to establish safety and efficacy of the new drug. Plants are considered as one of the main sources of important phytochemicals, secondary metabolites such as flavonoids, phenols, steroids, alkaloids, saponins and glycosides. These natural products as secondary metabolites open new possibilities for new formulations for herbal drugs. Family Asteraceae has got an imperative place among these remedial customs and known to be the largest family of the flowering plants comprising more than 24000 species. *Tridax procumbens* L. is one such super weed belonging to family Asteraceae which contains diverse medicinal components explored by research scientists. *Tridax* is commonly known as Tridax daisy or coat button in English and Ghamra in Hindi. The plant species contains a number of phytochemicals which possesses different pharmacological activities like antibacterial, antifungal, anticancerous, diuretic, anti-inflammatory, and various other important ethnomedicinal properties. The present study aims to open new avenues for the improvement of medicinal use of *T. procumbens* for various ailments. This review attempts to highlight the available literature on *T. procumbens* with respect to ethnobotany, chemical constituents and summary of various pharmacologic activities and to investigate the qualitative and quantitative analysis of phytochemicals from various

plant parts and also to analyze the presence of secondary metabolites specifically alkaloids, terpenoids, tannin, steroids, saponin, phenol, glycosides, flavonoids, carbohydrates and anthraquinones. The presence of various secondary metabolites proves that *T. procumbens* has enormous potential for development and novel drugs for human health care.

Mitotoxic potentiality of copper sulphate on *Allium Cepa*

Naina srivastava

Dept. of Botany, D.A.V. College, Dehradun

ABSTRACT

In Metaphase Some chemicals show genotoxic effect and their evaluation gives valuable information about aberration same observation was found in Carbofuran induced cytogenetic effects in root meristem cells of *Allium cepa* and *Allium sativum* which was spectroscopic approach for chromosome damage. Late separation due to disturbance in cytochemical changes. doubling of chromosomes and c mitosis Non separation causes bridges and acentric fragments are found due to late anaphase movement Retardation and early effected interphase cause lowering in mitotic index and in the correlation with same finding in *Vicia faba*. Abnormalities and chemical concentration have exponential relationship. Chemical solution in increasing concentrations creates significant decrease³ in mitotic division. in comparison to control concentration and time of treatment duration causes mitodepressive effect. *Allium cepa* root meristem acts as bioassay to observe aberration percentage. Sometime recovery of treated root by normal water. The mitotic index is observed. In lower concentration the abnormalities start like stickiness, chromosome clumping. after increasing concentration abnormal extruded chromosomes show abnormal polarity. Polarity abolition was very distinct in copper sulphate treatment. Other chemicals also create abnormal scattering of chromosomes. Same observation of cytotoxicity was observed. Heavy metal, copper stress, mutagenic chemicals food additives effected and it was also observed by mutagenic and mitodepressive. So the mitotoxic potentiality which is proved due all concentration of copper sulphate on *Allium cepa* is exponentially related with increasing abnormality.

Keywords: Chromosome aberration, Copper sulfate, Cytotoxicity

Antifungal properties of *pterocarpus santalinus* bark

Rakesh Kumar^{1*}, A Muthu Kumar², Souvik Ray¹, S.R. Shukla³, S.S. Bisht³

¹ *Wood Processing Division, Institute of Wood Science and Technology, Bangalore*

² *Forest Protection Division, Institute of Wood Science and Technology, Bangalore*

³ *Wood Properties and Uses Division, Institute of Wood Science and Technology, Bangalore*

ABSTRACT

The world has over exploited its natural resources. The urge to conserve the biodiversity has resulted in implementation of various laws and sustainable development ideas in people. The sustainable development along with the need to conserve the endemic species changed the perspective to value addition of these species such that they are conserved for their values. One of the most celebrated endemic and endangered species of India is *Pterocarpus santalinus* commonly known as the Red Sanders and is red listed due to its over-exploitation. The Red Sanders wood had been used since ancient times in furniture due to its exquisite color and also in various traditional medicines. The pharmacological studies exhibited the importance of the species other than the aesthetic values. Mainly the heartwood of Red Sanders is preferred globally due to its medicinal properties. But preliminary studies have shown that *Pterocarpus santalinus* bark also can be used for various pharmaceutical purposes. Keeping in accordance with the findings, an experiment was conducted to assess the antifungal properties of Red Sanders bark. Extractives obtained through different solvents were examined against fungi and promising results were obtained. Thus, a detailed study on the phytochemical constituents along with the antifungal properties of Red Sanders bark can add more value to the plant in both domestic and international markets. Thereby, it can be potentially utilized in developing bio preservative for protection of timber as it will aid in effective use of resources and promoting sustainability.

Keywords: *Pterocarpus santalinus* bark, antifungal properties, phytochemical, sustainable development

Nanosized Titania Based Heterogeneous Catalyst: An efficient nanocatalytic system in Click reaction

Neha Sharma*, Monika Gupta, Bushra Chowhan, Mobina Kouser

PG Department of Chemistry, University of Jammu, Jammu-180006, India

ABSTRACT

Catalysis is the most extensively studied branch of organic chemistry. It is still developing and nanocatalysis is another important field of catalysis. It involves the use of catalysts having a size in the range of 1-100 nm. These nanocatalysts have a high surface area and are highly efficient than conventional catalysts. However, they suffer from the drawback of recyclability. So, chemists are fascinated by the heterogeneous branch of nanocatalysis because heterogeneity adds to the recyclability of the catalyst. Recyclability, ease of handling are the various factors that make the heterogeneous nanocatalysts to lie in the domain of Green Chemistry. Nitrogen-containing heterocyclic compounds are the most abundant compounds found in nature. These intrigued the chemists as they have diverse biological properties such as anti-cancer, anti-fungal, anti-viral, anti-epileptic anti-tuberculosis and anti-bacterial activity. The unique structural and chemical properties possessed by the 1,2,3-triazoles make them important heterocyclic compound. 1,4-Disubstituted 1,2,3-triazoles can be used to selectively open calcium channels in cells, to regulate plant growth and to inhibit enzymes as well as exhibit significant proliferative action against a wide range of human cancer cell lines. Keeping in view the various advantages of heterogeneous nanocatalysts, we try to develop a heterogeneous nanometal catalyst and utilize it in the production of various 1,2,3-triazoles.

Traditional use of non- timber forest products: Boon for livelihood security of people in Shivalik range of Jammu region

Yudhishter Singh Bagal* and Stanzin Yangsdon

Division of Agricultural Extension Education, Sher-e-Kashmir University of Agricultural Sciences and Technology of Jammu, Chatha, Jammu 180009, Jammu and Kashmir, India

ABSTRACT

There has been increasing trends in the trade of forest products particularly Non Timber Forest Products (NTFPs). Increasing trade of forest products has supported economic growth of forest dwellers of many countries and there is strong evidence that forest products play a significant role in their livelihood. The individuals are totally reliant on the forest for their survival. The forest gives them their wellbeing in everyday life and provides economic benefit. The present exploratory study was conducted in Shivalik range of Jammu region to ascertain the role of identified NTFPs in the livelihood security of peasants. Participatory Rural Appraisal techniques were used to identify and document traditional NTFPs. The documented NTFPs were Patis (*Aconitum chasmanthum*), Gucchi (*Morchella esculenta* L.), Nag chhatri (*Trillium govaniatum*), Banafsaha (*Viola canescence*), Dhoop (*Jurinea macrocephala*), Kaurd (*Picorhiza kurroa*), Muskbala (*Valeriana hardwickii*), Kasrot (*Diplazium esculentum* sw.), Zakhm-e- hiyat (*Bergenia ciliata* Stein.) which play a catalyst role in the livelihood of people of Shivalik range of Jammu region.

Keywords: Non Timber Forest Products, Livelihood, Collection and marketing, Traditional knowledge

Influence of different levels of sulphur and biofertilizers on soil properties and yield of mulched Groundnut (*Arachis hypogaea* L.) in lateritic soils of Konkan region

Jadhav S. C., Salvi V. G., Kasture M. C., More S. S. and A. A. Walekar

Department of Soil Science and Agricultural Chemistry, College of Agriculture, Dapoli, Dr. Balasaheb Sawant Konkan Krishi Vidhyapeeth, Dapoli.

ABSTRACT

A field trial was conducted during two consecutive *Rabi* seasons of the year 2017-18 and 2018-19 to study the effect of different levels of sulphur and biofertilizers and on soil properties and yield of mulched Groundnut (*Arachis hypogaea* L.) in lateritic soils (Alfisols) of Konkan region. The experiment was conducted at Research Farm of Department of Agronomy, College of Agriculture, Dapoli Dist. Ratnagiri in Maharashtra. The experiment was undertaken with 16 treatments comprising four levels of sulphur i.e. 0, 15, 30, 45 kg ha⁻¹ and biofertilizers consisting without biofertilizer, *Rhizobium*, phosphorous solubilizing bacteria and sulphur oxidizing microorganisms along with 100 per cent recommended dose of fertilizers. It was revealed from the study that, the application of 45 kg ha⁻¹ sulphur significantly improved the chemical properties of soil except soil pH, while, those were significantly improved due to 0 kg ha⁻¹ sulphur. However, the application of sulphur oxidizing microorganisms @ 5 L in 200 L water ha⁻¹ through drenching significantly improved the available potassium of the soil whereas, the application of

rhizobium @ 20 g kg⁻¹ seed through seed treatment improved pH, organic carbon and available nitrogen in soil. The electrical conductivity and available phosphorous content in soil was improved due to application of phosphorous solubilizing bacteria @ 25 g kg⁻¹ seed through seed treatment. Thus the combined application of sulphur @ 45 kg ha⁻¹ alongwith sulphur oxidizing microorganisms @ 5 L in 200 L water ha⁻¹ through drenching during *Rabi* season is beneficial for getting maximum yield of groundnut for the Konkan region of Maharashtra.

Keywords: Groundnut, Yield, Physico-chemical properties, Nitrogen, Phosphorous, Potassium

Effect of iron, zinc and boron on growth, yield, quality and storability of onion (*Allium cepa* L.) Cv. Agrifound light red

S. G. MORE* and L. R. VARMA

College of Horticulture, S.D. Agricultural University, Jagudan-Gujarat

ABSTRACT

The investigation entitled “Effect of iron, zinc and boron on growth, yield, quality and storability of onion (*Allium cepa* L.) cv. Agrifound Light Red” comprising twenty seven treatment combinations with three levels of each viz., iron (0, 20 and 40 kg/ha), zinc (0, 25, and 50 kg/ha) and boron (0, 2.5 and 5.0 kg/ha) were tested in Randomized Block Design (under factorial concept) with three replications at Horticulture Instructional Farm, Department of Horticulture, C.P. College of Agriculture, Sardarkrushinagar, Distt. Banaskantha, Gujarat during *rabi* 2013-14 and 2014-15. The treatments were evaluated on the basis of growth parameters, yield and yield attributes, quality parameters and storability observations which were subjected to statistical analysis. The treatments were applied in the form of zinc sulphate, iron sulphate and borax. The results revealed that the status of available iron, zinc and boron in soil before crop transplanting were not significant. The interaction effect between iron, zinc and boron on available boron before crop transplanting was found significant under treatment combination $i_2z_2b_2$. The treatment i_1 was significantly showed maximum plant height at 30 and 90 DAT, number of leaves per plant and neck thickness at 30, 60 and 90 DAT respectively, minimum neck thickness at the time of harvesting and minimum days taken to maturity after transplanting. Significantly maximum plant stand in field at 30 DAT, plant height, number of leaves per plant at 60 and 90 DAT respectively and neck thickness at 30 and 90 DAT respectively and minimum days taken to maturity after transplanting were recorded with treatment z_1 . Significantly maximum plant height at 30 DAT, number of leaves per plant at 30 and 60 DAT, neck thickness at 90 DAT as well as minimum neck thickness at the time of harvesting and per cent bolting were recorded with treatment b_2 . The treatment b_1 was found significantly maximum plant height and number of leaves per plant at 90 DAT. Interaction effect between iron and zinc on maximum number of leaves and neck thickness at 30 DAT was recorded with treatment combination i_1z_1 which was statistically significant. While significant variation on minimum per cent bolting recorded with treatment combination i_1b_2 . In case of yield attributes and yield, the significantly superior treatment was i_1 (20 kg iron/ha) with bulb weight, yield/plot and yield/ha. Application of zinc @ 25 kg/ha was reported to produce significant results with yield attributes and yield. Boron @ 5.0 kg/ha was found significantly superior for yield parameters bulb weight, yield/plot and bulb yield/ha. Interaction between iron and zinc significant for weight of bulb was observed with treatment combination i_1z_1 . With respect to quality parameters, the diameter of bulb, neck thickness after curing and TSS (⁰Brix) were recorded with treatment i_1 . The treatment z_1 recorded significantly maximum diameter of bulb. Treatment b_2 showed significantly maximum diameter of bulb, TSS (⁰Brix) and minimum neck thickness after curing. Interaction effect between (iron and zinc) and (iron, zinc and boron) were found significant on TSS was recorded with treatment combination i_1z_0 and $i_1z_0b_2$. The treatment i_1 recorded significantly maximum recovery of fresh onion after two month of storage and minimum losses due to dry scale, spoilage and sprouting after one and two month of storage. The treatment z_1 recorded significantly minimum losses due to dry scale, spoilage and sprouting after one, two and three month of storage. 5.0 kg boron/ha treatment recorded significantly minimum losses due to dry scale, spoilage and sprouting after one and two month of storage, maximum recovery of fresh onion after one, two and three month of storage and percent recovery of fresh onion after three month of storage. Whereas, treatment b_1 was observed significantly minimum losses due to dry scale, spoilage and sprouting after three month of storage. Interaction effect between (iron and zinc) and (iron, zinc and boron) were found significant on minimum losses due to dry scale, spoilage and sprouting after one month of storage were observed with treatment combination i_1z_1 and $i_1z_1b_2$ respectively. The result revealed that the status of available iron and zinc in soil after crop harvesting were found not significant. Treatment b_2 obtained maximum boron content in the soil after crop harvesting. Economics of different levels of iron, the treatment i_1 reported the highest gross realization, net realization and highest benefit cost ratio. In case of different zinc treatments, maximum gross realization, net realization and highest benefit cost ratio were obtained with treatment z_1 . The economics of different levels of

boron, the treatment b₂ obtained the highest gross realization, net realization. The highest benefit cost ratio was recorded with treatment b₁. The cultivation of onion with the application of iron 20 kg/ha, zinc 25 kg/ha and boron 2.5 kg/ha may achieve highest growth, yield, quality, storability and net profit.

Keywords: Onion, Allium, Rabi, Storage Life, Iron, Zinc and Boron

Development and optimization of semi-automated hot air puffing system for millets

Surpam, T. B.¹, Pardeshi, I. L.² and Rokade, H. N.³

¹*KrishiVigyan Kendra, Khamgaon, VNMKV, Parbhani*

²*Deptt. of Food Grains and Seeds, PGI of PHM, Roha-Raigad, Dr. BSKKV, Rahuri*

³*NAHEP, VNMKV, Parbhani*

ABSTRACT

The puffing process can broadly be classified as the sand puffing, salt puffing, air puffing, oil puffing and roller puffing. Puffing is a simplest inexpensive and quickest traditional method of dry heat application, wherein grains are exposed to high temperature for short time (HTST). The semi automated multigrain continuous hot air puffing system operate with 1 hp electric power source for blower, 11 heater with capacity of 0.75 KW with puffing capacity of 6 to 8 kg/h. The system consists of electric heating assembly, continuous feeding system, continuous outlet system, cyclone separator and re-circulation of air unit. The optimized parameter for hot air puffing of sorghum and bajra were 0.025 and 0.22 kg/kg dm initial moisture content, 285°C and 355 °C puffing temperature, 5.5 and 4 m/s air velocity and 7982 and 8250 g/h feed rate respectively. As moisture content of whole grain was very low to impart puffing, the moisture content of whole grain was increased to a predetermined level for maximum expansion effect and puffing yield. The sample of finger millet, kodo and kutki did not required additional moisture, because the whole grain moisture content was adequate for better puffing. The finger millet is not amenable for puffing in the form of whole grains, because, the seed coat of the finger millet grains if not removed it not only affects the puffing quality but also its expansion ratio. The endosperm of the millet is covered with the rigid seed coat. Since, the Seed coat is firmly attached to the endosperm, the decortication becomes inevitable for puffing purpose. The optimized parameter for hot air puffing of decorticated finger millet, kodo millet and kutki were 330, 270, and 380 °C puffing temperature, 2.5, 3.5 and 2.5 m/s air velocity and 6608, 6608 and 7686 g/h feed rate respectively.

Keywords: Millet, HTST, Hot air puffing, RTE

Growth performance of gir heifer on feeding of jowar straw in combination with soybean straw

Dr. S. D. Chavan, Dr. S. P. Nage, Dr. S. R. Shegokar

Department of Animal Husbandry and Dairy Science, Dr. PDKV, Akola

ABSTRACT

The research experiment was conducted was conducted for period of 120 days on six Gir heifers were divided into two groups on the nearness of age and weight. Three feeding treatment were studied namely T1 (Jowar straw 100% + hybrid napier + concentrate), T2 (50% Jowar straw + 50% Soybean straw + hybrid napier + concentrate), T3 (50% Jowar straw + 50% Salt treated Soybean straw + hybrid napier + concentrate) to fulfil requirement of gir heifer in all treatments. Dry, green fodder and concentrate mixture were provided as per thumb rule. It was observed that 2% salt treated soybean straw was containing 7.64, 1.73, 38.94, 41.31, 11.89 and 8.75, 1.75, 37.89, 39.16, 11.94 per cent, CP, EE, NFE, CF and ash while jowar straw was containing 2.75, 2.90, 50.47, 35.42 and 8.68 per cent CP, EE, NFE, CF and ash respectively. Daily DM intake differed non-significantly between the treatments. The heifer from T3 groups consumed more DM than that of T1 and T2 heifers. The average daily dry matter intake was 6.51, 6.68 and 7.05 kg/day/heifer in T1, T2 and T3 groups respectively. This trend thus indicated that there was increase in the daily DM intake when 2% salt treated soybean straw and jowar straw incorporated as roughage in the rations of heifer. All the heifers exhibited satisfactory growth rate of 358 to 470 g per day and differences were significant. It is concluded that, 50 % Jowar straw in combination with 50 % Soybean straw could meet the maintenance and production requirement of the Gir heifers

Keywords: Gir, Heifer, Soybean, Jowar, Straw, Feeding

Soil quality assessment of rural and peri-urban areas of southern transect of Bengaluru (Principal component analysis)

Altaf kuntoji¹, Subbarayappa C. T.¹, Chamegowda T. C.¹, Sathish A.¹, Ramamurthy V.¹ and Mallesha B. C.²

¹*Department of Soil Science and Agricultural Chemistry, National bureau of soil survey and land use planning, Hebbal, Bengaluru*

²*Department of Microbiology, UAS, GKVK Bengaluru- 65 Karnataka*

ABSTRACT

Environmental degradation is caused by urbanization in developing countries and harms human health. Due to urbanization of the Bengaluru city, the soil and water quality are degrading year by year in the surrounding areas with this our objective was to evaluate the soil quality of rural and peri-urban areas of southern transect of Bengaluru. The results indicated that soil pH ranges from 5.10 to 8.56 in rural and 4.23 to 8.50 in peri-urban. Among the different regions of southern transect of Bengaluru, soils of rural areas had recorded significantly higher available nitrogen (323.01 kg ha⁻¹), phosphorus (28.98 kg ha⁻¹), potassium (246.16 kg ha⁻¹), Exchangeable Ca [9.67 c mol (p⁺) kg⁻¹ soil], Mg [7.22 c mol (p+) kg⁻¹ soil], available sulphur (19.32 kg ha⁻¹), Zn (0.73 ppm), B (0.84 ppm) and DHA activity (14.59 µg TPF g⁻¹ soil 24 h⁻¹) compared peri-urban. Soils from peri urban areas were recorded higher Cd (0.041ppm), Cr (0.049 ppm), Pb (0.033 ppm) and Ni (0.043 ppm). To evaluate soil quality index of rural and peri-urban areas, principal component analysis approached was followed. Based on rotated factor loadings of soil attributes, selected indicators were: organic carbon, soil pH, sulphur, phosphorus and clay. These selected indicators were converted into scores by linear scoring method and soil quality index was worked out. The rural soil quality index was 0.61 and peri-urban was 0.54. Conclusively, soil quality of southern transect of Bengaluru fall under medium category of soil quality (0.50-0.75).

Keywords: Soil quality, Minimum data set, Rural and Peri-urban of southern transect of Bengaluru

Plasma technology in Agriculture

Shivani Kumari^{1*}, Lanunola Tzudir¹, Sushilkumar S.¹, Meshram, M. R.², Lalit Kumar Sanodiya²

¹*School of Agricultural Sciences and Rural Development (SASRD), Nagaland University, Medziphema, Nagaland*

²*Naini Agricultural Institute, SHUATS, Prayagraj, Uttar Pradesh*

ABSTRACT

Plasma is electrically neutral ionized gas which has been hypothesized to be effective in several domains. In recent years the application of Non-thermal plasma (NTP) or Cold plasma or Low Temperature Plasmas (LTPs), a modern eco-agricultural high-tech technique in agriculture is rapidly increasing. Plasma technology has potential to address the challenges faced by present day agriculture in food production. Non-thermal plasma stimulates seed germination, seedling growth, yield as well as productivity of crops at lower rate. Plasma technology is a novel approach which not only enhances the yield and quality of crop, but also helps in reducing stresses faced by seeds at time of germination due to biotic or abiotic factors. It provides sterilization and disinfection against pathogens, conserves irrigation water through recirculation and water retention by soil, insect control and retention of quality of agricultural product. Being an energy efficient and environment friendly technology it has potential to face the challenges of population growth, environmental pollution and climate change while ensuring the quality of the agricultural products and the preservation of resources and habitats. Hence, there is need to optimize and upgrade the applications of plasma on plant production to ensure the global food security and sustainability.

Keywords: abiotic, biotic, climate change, productivity, security, sustainability.

Studies on shrikhand blended with guava (*Psidium guajava* L.) Pulp

S. P. Nage, S. D. Chavan, S. R. Shegokar, R. D. Dhage

Department of Animal Husbandry and Dairy Science, Dr. PDKV, Akola

ABSTRACT

The present study was conducted at department of Animal Husbandry and Dairy Science, Dr. Panjabrao Deshmukh Krishi Vidyapeeth, Akola. An effort was made to standardize the optimum level of guava pulp in the preparation of

3rd International Conference on “Global Initiative in Agricultural, Forestry and Applied Sciences for Food Security, Environmental Safety and Sustainable Development (GIAFAS-2021)”

shrikhand, with main objects to evaluate the product by sensory evaluation, determination of chemical composition and to calculate cost of production with five treatments including control T₁ and shrikhand prepared from cow milk chakka with different level of guava pulp i.e. 5 per cent, 10 per cent, 15 per cent, and 20 per cent in treatment T₂, T₃, T₄ and T₅ respectively. It was observed that, the mean score of flavour of shrikhand in treatment T₄ was highest (42.40) and lowest in T₅ (38.00). The average score for body and texture of shrikhand was highest in T₄ (33.40) and lowest in T₅ (29.20). As regard for colour and appearances showed the highest score in T₄ (18.60) and lowest in T₅ (17.00) Treatment T₄ (94.80) showed highest overall acceptability score over other treatments. This superiority was found due to addition of 15 per cent guava pulp in shrikhand. As regards to the cost of production per kg shrikhand was lowest in T₅ (Rs. 121.49 per kg) and highest in T₁ (Rs.128.10 per kg).Which indicates that increase in the level of guava pulp showed decrease in cost of production of shrikhand. From the present study it can be concluded that, acceptable quality shrikhand can be prepared by adding 15 per cent guava pulp.

Keywords: Cow milk, Chakka, Guava, Shrikhand

To study the effect of different packaging material on apple ber candy over different storage periods

S.R.Gavali, D.N.Vishwasaneand and S.J. Veer

Department of Food Science and Technology, Post Graduate Institute, Mahatma Phule Krishi Vidyapeeth, Rahuri, Dist-Ahmadnagar (M.S.) 413722

ABSTRACT

The present investigation was aimed to evaluate physicochemical properties of prepared apple ber candy, furthermore prepared candy was evaluated for sensory attributes and assessed for storage stability stored under different packaging material for the period of 90 days of storage. The apple ber fruits were blanched and steeped in different sugar levels i.e 700 and 750 brix and different citric acid concentrations i.e 0.5%, 1% and 1.5%. From sensorial evaluation it was evident that candy prepared with 700 Brix sugar syrup and 1% citric acid found to be optimum as per hedonic rating and this optimized product were stored in different packaging materials i.e. LDPE, HDPE, PET jar for 90 days.. The stored candy was evaluated for chemical composition viz., moisture, TSS, total sugars, reducing sugars, non-reducing sugars, titrable acidity, ascorbic acid and calcium and organoleptic properties viz., colour and appearance, texture, flavor, taste and overall acceptability at 0, 30, 60 and 90 days of storage in different packaging materials. From the storage study it was concluded that there was gradual decrease in moisture, non-reducing sugars, ascorbic acid and calcium contents and increase in reducing sugar, total sugar, TSS, acidity of apple ber candy. Apple ber candy prepared with sugar (70 OBrix) and citric acid (1%) showed better organoleptic properties as well as good storage stability in different storage conditions up to 3 months. Based on evaluation candy stored in HDPE were found optimum with respect to nutrient content and organoleptic properties.

Keywords: Apple ber, candy, Quality attributes, Sensory.

Haematological Indices of Vanraja Poultry Birds Fed Aloe vera (*Aloe barbadensis*) and Neem (*Azadirachta indica*) Leaves Powder

S. D. Gadekar*, S. D. Chavan and S. P. Nage

Department of Animal Husbandry and Dairy science, Dr. Panjabrao Deshmukh Krishi Vidyapeeth, Akola, (M. S.), India

ABSTRACT

To determine the effect of using *Aloe vera* and Neem leaves powder on carcass characteristics and some haematological parameters in vanraja poultry birds, a total 270 a day old chicks with an average identical weight were divided into 9 treatments with 3 replicates as factorial randomized block design experiment. The birds were fed by basal diet as control diet, Aloe vera, Neem leaves powder based diet and different combinations of aloe vera and neem leaves powder. On the basis of data obtained on haemato-biochemical parameters, there was significantly increased in haemoglobin values in T₆ (11.70 g/dl) followed by T₈ (11.10 g/dl), T₂ and T₅ (10.90 g/dl), T₉ (10.80), T₇ (10.76 g/dl), T₄ (10.48 g/dl) and lowest in T₁ (9.11 g/dl). The PCV count was 28.72, 29.97, 33.63, 31.80, 32.81, 37.72, 32.97, 32.96 and 32.95 per cent for treatment groups T₁, T₂, T₃, T₄, T₅, T₆, T₇, T₈ and T₉, respectively. It was revealed that the PCV count of treatment group T₆ (37.72 per cent) was significantly (P<0.05) higher than all groups. The RBC count was 2.75, 2.87, 2.59, 2.89, 2.87, 2.93, 2.75, 2.73 and 2.73 10⁶/ mm³ for the treatment groups T₁, T₂, T₃, T₄, T₅, T₆, T₇, T₈ and T₉, respectively. Thus, there were significant (P<0.05) increase RBC

3rd International Conference on “Global Initiative in Agricultural, Forestry and Applied Sciences for Food Security, Environmental Safety and Sustainable Development (GIAFAS-2021)”

values in respective treatments. The WBC count was 35148.69, 36236.05, 35172.08, 35282.31, 33651.07, 36418.06, 35062.18, 34778.28 and 34609.48 Cells/ mm³ for the treatment groups T1, T2, T3, T4, T5, T6, T7, T8 and T9, respectively. Thus, there were significant increase WBC values in respective treatments. T6 (36418.18) Cells/ mm³ had the highest WBC level among the treatments. As result relevant from this study using of *Aloe vera* and Neem leaves powder in diet may be useful and have significantly effects on some blood biochemical parameters on Vanraja poultry birds.

Keywords: Aloe vera, Neem, Haematological, Vanraja

An era of plant breeding in india: molecular breeding

Ruchi Bishnoi¹ and Akash Barela²

¹*Sam Higginbottom University of Agriculture, Technology and Science, Prayagraj, U.P.*

²*JNKVV, Jabalpur, M.P.*

ABSTRACT

The scientific basis for genetics and plant breeding was established by the famous discoveries of Mendel and Darwin. Recently, the integration of biotechnology, genomics and molecular markers with conventional breeding methods has started an era of molecular breeding, an inter-disciplinary science which is revolutionizing today's crop improvement in India. Molecular breeding has significant value in recent advances in plant breeding. For an instance it has been used in oilseed crops for climate resilience, for conservation of genomic diversity in many cereals crops landraces, for improvement of abiotic stress tolerance in wheat and for resistance to biotic stress tolerance in rice. The initial phase of molecular breeding started with the identification of anonymous DNA markers co-segregating with target traits and performing marker-based selection of traits for example Recombinant inbred lines (RILs), double haploids and back cross population are more dominant markers like AFLP and ISSR. However, co-dominant markers like SSRs and SNPs are more suitable for genetic mapping in populations containing heterozygotes. Molecular techniques, agrobacterium-mediated transformation, MAS and genomic selection has been tremendously be used in many crops. To increase genetic variation Multi-parent Advanced Generation Inter-cross (MAGIC) populations have been developed in a number of crop species including rice, wheat, maize, cotton, and jute. This population can be used for both linkage and association mapping for large-scale gene-trait analysis. This part will be discussed by using research papers on rice, wheat and maize, with a small reference to pulses and oil seed crops.

Keywords: MAS, Molecular breeding, Genomic selection, GWS

Nutritional Gardening: A way to achieve Food and Nutritional security in rural areas of Jammu (J&K)

Poonam Abrol

Department of Community Science, EECM, Punjab Agricultural University, Ludhiana

ABSTRACT

Home gardening is a centuries-old and commonly adopted practice all over the world. Kitchen gardens provide cheap vegetables; reduce daily food costs and also protecting the environment. Home gardens are termed in the literature as mixed, kitchen, backyard, farmyard, compound, or homestead gardens. India is the second-largest producer of food in the world but stood also in the same rank in undernourished population. The unavailability of food and poor diet is directly linked to high rates of stunting, obesity, and death in children under the age of five. Furthermore, anaemia affects more than half of women in India, which is one of the causes of the high rate of low-birth-weight babies. As a result, there is a need to ensure the growth and use of micronutrient-rich food crops by enabling economically disadvantaged members of our society (nutritionally and financially), and assisting them in growing, consuming, and selling fresh produce to improve food and nutrition security at the household level. The Indian government has implemented programmes to ensure food security and access to adequate quantities of high-quality food. To address the issue of food security, multiple strategies must be considered. One of the strategies is to promote nutritional gardens at the household level. The study was undertaken to promote kitchen gardening in rural areas and to analyse the role of kitchen and homestead gardens on increasing vegetable and fruit consumption among rural women. For this, nutritional kits were distributed among rural women and training was conducted to provide the technical know-how for growing vegetables. Both qualitative and quantitative data were collected from rural women. A purposive sampling method was used to choose the respondents. Only those women (60) were chosen as a part of the study to whom the kitchen garden kits were provided. The findings show that after the

3rd International Conference on “Global Initiative in Agricultural, Forestry and Applied Sciences for Food Security, Environmental Safety and Sustainable Development (GIAFAS-2021)”

intervention, the majority (72%) of rural women have adopted small kitchen gardens in their homes. They were also utilizing kitchen waste to irrigate the nutritional garden. The majority of them have designed a kitchen garden in an 8-square-metre area that was large enough to produce sufficient vegetables for the household. Almost all women consume green leafy vegetables daily, which were not a part of their diet earlier. The promotion of nutritional gardens in rural areas brings a positive impact on their lives. Almost 60% of the respondents do not buy vegetables after growing vegetables at home. All the respondents were in a view that the kitchen garden has improved their nutritional diversity. It was also observed that a total of 12 varieties of green leafy vegetables (including spinach, carrot, beans, peas and radish etc) and fruits (lime, orange and guava) were sown by rural women thus indicating that a wide diversity has been achieved. About 90% have learnt a new skill indicating that the kitchen gardening activities seems to be positively addressing food security and nutritional diversity. Therefore it can be said that promoting nutritional gardens in rural areas can play a vital role in combating malnutrition by enhancing national food security and dietary diversity. These tiny gardens not only are the source of better quality and more nutritious foods but are environmentally friendly and conserve natural resources also.

Keywords: rural women, kitchen gardening, food security, nutritional security.

Molecular breeding for the development of hybrid onion Hira Singh, Anil Khar, Masochon Zimik and Priyanka Verma

Division of Vegetable Science, ICAR-IARI, New Delhi 110012

ABSTRACT

Onion, (*Allium cepa*, $2n=2x=16$) belonging to the family Amaryllidaceae, is one of the most important bulbous vegetable crop, used for table, cooking and processing purposes globally. Being a biennial and highly cross pollinated crop, conventional breeding is very difficult and cumbersome. That's why limited work on the development of hybrids in India has been conducted. Male sterility is the most preferred mechanism for the hybrid development in onion. Identification and isolation of stable male sterile and maintainers are the critical factors for the achievement to develop hybrids. Marker assisted breeding is the best option to boost the onion breeding program for the development of hybrids. Since onion hybrids possess more uniformity and stability in size, colour, shape, maturity and tolerance various stresses under rapidly changing climatic conditions. Normal and sterile cytoplasms have been detected in onion through well established specific markers such as accD and MKFR. While Ms locus has been well detected by using precisely specific PCR based molecular markers such as OPT, AcSKP-1, jnurf-13 and AcPMS-1 have been preferred worldwide. In India, productivity can be increased by hybrids, but till now no commercially popular hybrid is released from the public sector. At the national level, research work on onion hybrids has not been focused, which might be due to the non-availability of stable male sterile and maintainer lines and the time involved in identification through conventional means. Using various PCR markers, we observed the maximum frequency of 'N' cytoplasm, while also identified 'S' cytoplasm in few commercial varieties but in a very low frequency. To be concluded, marker assisted selection is the best option to speed up the development of hybrid onion cultivars to augment onion productivity.

Impact of Gibberellic Acid on Growth and Flowering Parameters of African Marigold (*Tagetes erecta* L.) cv. Pusa Basanti Gaiinda in Western Plain Zone of U.P.

Toryalay Bajawri, Sunil Malik, Mukesh Kumar, S.K. Tirpathi, Ravindra Kumar and Bhim Singh
Sardar Vallabhbhai Patel University of Agriculture & Technology, Modipuram, Meerut 250110 India

ABSTRACT

Present study was carried out at the Horticultural Research Centre (HRC) of Sardar Vallabhbhai Patel University of Agriculture and Technology Modipuram, Meerut, Uttar Pradesh during the year 2020. The findings of the present study are summarized below. The experiment was laid out in Randomized Block Design (RBD) with nine treatments and three replications. Treatment details were T₁ (Control), T₂ (GA₃ @ 50 ppm), T₃ (GA₃ @ 100 ppm), T₄ (GA₃ @ 150 ppm), T₅ (GA₃ @ 200 ppm) T₆ (GA₃ @ 250 ppm), T₇ (GA₃ @ 300 ppm), T₈ (GA₃ @ 350 ppm) and T₉ (GA₃ @ 400 ppm) 20 DAT. The maximum plant height (85.70 cm) at 60 days stage under the treatment T₆ and minimum plant height was recorded under the control (T₁). The maximum plant spread east to west (24.97 cm) at 60 days stage under the treatment T₆ and minimum plant spread from east to west was recorded under the control (T₁). The maximum plant spread of north to south (25.50 cm) was found when plant sprayed with T₆ at 60 days of observation, whereas minimum plant spread of north to south was recorded under the control (T₁). The maximum

number of branches per plant (18.17) was recorded when plants were sprayed with the treatment T₆ at 60 days of observation and the minimum number of branches per plant was observed under the control (T₁). The minimum days taken to first flower bud appearance T₆ emerged earlier flower bud initiation (41.20 days), however the maximum days bud appearance of first flower (54.61 days) were taken under the control (T₁). The minimum number days taken to opening of first flower (81.20 days) were noted under the treatment T₆. However, the maximum days taken to opening of first flower (91.87 days) were taken under control (T₁). The maximum duration of flowering (71.99 days) when plants were treated with T₆ and minimum duration of flowering (50.87) had been registered with control (T₁). Flower weight was also maximum under T₆ recorded significantly highest weight of flower (9.87 g) under the treatment of T₆ and minimum weight of flower (4.93 g) was registered with control (T₁). The number of flower per plant (47.40) was obtained from the plant treated with T₆ and minimum number of flowers per plant (29.27) under T₄ was recorded. Among the treatments applied, the maximum flower yield per plant (809.72 g) obtained under the treatment T₅ and the minimum flower yield per plant (388.40 g) was noted under the treatment control (T₁). The flower yield per plot was significantly affected by the application of different concentrations of GA₃ of application in comparison with control. Among the treatments T₅ gave maximum flower yield per plot (6.66 Kg) and minimum flower yield per plot (3.72 Kg) were noted under control (T₁). Flower yield was significantly affected by the GA₃ as compared to control (T₁). Among the treatments, the maximum flower yield per hectare (255.92 q/ha) had been recorded when the plants were sprayed with T₅ and the lowest flower yield per hectare (143.26 q/ha) was found under control (T₁).

Production Potential and Economic Viability of Buckwheat (*Fagopyrum esculentum*) as influenced by Integrated Nutrient Management in Northern Hill Region of Chhattisgarh Sandeep Sharma*, C.P. Rahangdale, P.K. Lakra, S.C. Pankaj, S.P. Gupta and Pushpendra Singh Krishi Vigyan Kendra, Mainpat, Indira Gandhi Krishi Vishwavidyalaya, Raipur, C.G.

ABSTRACT

Buckwheat (*Fagopyrum esculentum*) is one of the traditional underutilized crop which has high food value, can be grown in harsh climatic condition with minimum input. Buckwheat grains are highly nutritious in terms of mineral, protein, amino acids and deficient in lysine. Buckwheat is widely grown in northeastern state of India and also grown in some part of northern hill region (Mainpat in Surguja and Samripat in Balrampur district) of Chhattisgarh. Keeping in view the importance of buckwheat crop, Krishi Vigyan Kendra Mainpat conducted on-farm trials to popularize the improved technology (integrated nutrient management) in buckwheat on farmer's fields for effective transfer of generated technology and fill the gap between recommended technology and traditional farmer's practices. During the study total 24 on-farm demonstration were conducted in 10 ha area during two consecutive years 2018-19 and 2019-20 respectively. The result revealed that variation in yield due to agro-climatic parameters in northern hill region. The average plant height, no. of branches per plant and test weight (i.e., 79.2 cm, 5.7 and 24.0 g) was higher under recommended practice over the farmer practice (i.e., 66.2 cm, 4.7 and 21.1. The average yield of demonstration plots of buckwheat achieved by recommended practice was 8.4 q ha⁻¹ as compared to farmers practice 5.2 q ha⁻¹. The adoption of recommended practice increased yield by 60.5 per cent over the farmer's practice. Average technology gape, extensions gape and technology index were calculated 4.2 q ha⁻¹ 3.2 q ha⁻¹, and 33.2 per cent respectively. When economics viability was taken into consideration, it was found that, the net return of Rs 18100 per ha was found under recommended practice over the farmers practices of Rs. 7830 per ha with an average additional income of Rs. 10270 per ha, which is much encouraging and it is suggested for adoption of integrated nutrient management by farmers in the northern hill's regions of Chhattisgarh for more production and higher profitability of buckwheat crop.

Keywords: Buckwheat, production potential, technology gape and index, economic viability

Efficacy of azoxystrobin + difenoconazole against *colletotrichum falcatum* w. Causing red rot in sugarcane

Mohd Irshad*, Anwar Ahmad, Dr. Sujeet Pratap singh, Dr. Ajay kumar

Uttar Pardesh Council of Sugarcane Research- Shahjahanpur

**Chaudhary Charan Singh University –Meerut*

ABSTRACT

Sugarcane diseases are constraints to crop production all over the world, and no country is protected from the destructive influences of plant pathogens and pests. More than 125 diseases of sugarcane caused by fungi, bacteria, viruses, phytoplasma and nematodes have been reported from all over the world. Red rot caused by *Colletotrichum falcatum*, is a devastating fungal disease posing a serious threat to sugarcane cultivation in India. The present study was conducted in the Laboratory of Plant Pathology, efficacy of Azoxystrobin + Difenconazole against *Colletotrichum falcatum* W. causing red rot in sugarcane. Surface sterilized with 0.1% bleach for approximately 2 minutes then washed three times with distilled water and placed on petri plates having potato dextrose agar (PDA). Petri plates were incubated at $28 \pm 1^\circ\text{C}$ for one week to check the sporulation for further studies. Single spore technique used for obtaining pure culture by incubating at 28°C for one week and observed it daily to get rid of contamination. Fungicides are specific in their action and specificity for various genus and species. Amistar top fungicide was found effective at 50 and 100 ppm for the suppression of radial growth of two pathotype/isolate of *C. falcatum*. The fungicide evaluated after seven days of colony growth by was taken inhibition percentage of all tested concentrations such as 1, 2, 5, 10, 50 and 100 ppm. Data regarding inhibition percentage of *C. Falcatum* (Cf 08) revealed that Amistar top was the effective fungicide was inhibited mycelial growth at all concentrations. 1 to 100 ppm with inhibition percent of 66.03 to 93.70. Results in current study showed that by increasing concentration of Amistar top. Fungicides can inhibit *C. falcatum* (Cf 08 and Cf 0238) efficiently and can be used for treatment of red rot disease of sugarcane. The controlling of red rot disease such as use of systemic fungicide Amistar top for activation of plant defense system can be used.

Assessment of genetic variability, heritability, genetic advance, character association and path coefficient for grain yield and its attributing traits in wheat (*Triticum aestivum* L. Em. Thell) in eastern uttar pradesh

Mithilesh Kumar Chaurasiya¹, Tarkeshwar^{2*}, Kamlesh Kumar¹, Soni Singh² and S.C. Gaur¹

¹Department of Genetics and Plant Breeding, Baba Raghav Das Post Graduate College, Deoria – 274 001 (U.P.)

²Acharya Narendra Deva University of Agriculture and Technology, Kumarganj, Ayodhya – 224 229 (U.P.)

ABSTRACT

The present study was conducted with 72 germplasm lines with three checks to in rabi 2016-2017 to evaluate the extent of genetic variability, heritability, genetic advance, association among the traits and direct and indirect effects of traits on grain yield, in augmented block design for the fourteen characters of wheat (*Triticum aestivum* L. em. Thell) at the Agriculture Research Farm of B.R.D. Post Graduate College, Deoria (U.P.) under timely sown and normal soil conditions. The analysis of variance revealed that variance due to blocks were highly significant for the traits days to 50% flowering, number of grains per spike and biological yield per plant while variance due to check were highly significant for the traits days to 50% flowering, plant height, days to maturity, peduncle length and number of grains per spike. High estimates of broad sense heritability (>75%) was observed for the characters days to maturity, days to 50% flowering and biological yield per plant while number of grains per spike, grain yield per plant and spike/ear length showed moderate level of heritability (50-75%). Further, high estimates of genetic advance in percent over mean was recorded for biological yield per plant and grain yield per plant. Correlation analysis revealed that most of the traits were showed significant positive correlation with grain yield per plant except days to maturity and flag leaf area at phenotypic level. Grain yield per spike was positively associated with number of grains per spike, 1000-grains weight and harvest index. Based on path coefficient analysis, biological yield per plant and harvest index found to have direct effects on grain yield. Most of the traits exerted substantial amount of indirect effects on grain per plant via biological yield per plant except days to maturity, 1000-grains weight and harvest index.

Keywords: wheat, heritability, genetic advance, correlation coefficient, path coefficient, grain yield.

Generation of multiparent advanced generation intercrossed (magic) population and their utilization in crop improvement

Kamlesh Kumar¹, Tarkeshwar², Soni Singh² and Govind Mishra²

¹Department of Genetics and Plant Breeding, B.R.D.P.G. College, Deoria, U.P.

²Department of Genetics and Plant Breeding, A.N.D.U.A.&T., Kumarganj, Ayodhya (U.P.)

ABSTRACT

3rd International Conference on “Global Initiative in Agricultural, Forestry and Applied Sciences for Food Security, Environmental Safety and Sustainable Development (GIAFAS-2021)”

The identification of gene-trait associations for complex (multi-genic) traits needs a mapping population. Mainly two methods viz., biparental crosses and association mapping or linkage disequilibrium mapping, have been used for a long time in the identification of gene-trait associations. The major disadvantage of a biparental population is narrow genetic base, reduction of genetic heterogeneity and only two allelic variations can be analysed in these populations. Association mapping requires large samples and is predominantly influenced by unknown population structure. Recently, the QTL mapping using multi-parent populations has become very popular. The use of MAGIC populations for QTL analysis can fill the gap between biparental mapping and association mapping using natural or breeding populations. MAGIC provides more abundant genetic diversity than a biparental population and higher allele balanced frequency than the panels consisting of diverse accessions in AM and increased mapping resolution by taking the advantages of both historical and synthetic recombination.

Keywords: Advanced inter-crossed line, Biparental linkage analysis, Linkage disequilibrium mapping, MAGIC population.

Bioprospecting and endophytic fungal assemblages of mangrove plant *Avicennia marina* Thirumalesh B.V.*

Microbial Processes and Technology Division, CSIR-National Institute for Interdisciplinary Science and Technology, Pappanamcode, Kerala-695019

ABSTRACT

Mangroves are forest wetlands located across the intertidal zones of the tropics and subtropics in the creeks and estuaries. Mangrove plants act as primary producers in the estuarine food chain and they produce novel metabolites unique to the environment with various important economic and environmental functions. Endophytes are hidden within healthy host plants are a poorly investigated group of microorganisms, but they represented an abundant and dependable source of novel bioactive compounds with huge potential for exploitation in a wide variety of medical, agricultural, and industrial areas. Healthy mangrove plants of *Avicennia marina* were collected from the area of mangrove forest coastal region of Ernakulum and Kollam districts in Kerala. Plants were identified based on the description, the wild plant samples. Endophytic fungi are obtained after surface-sterilization of the plant tissues. Each plant tissue will cut into 2–3 mm sections and placed on potato dextrose agar (PDA) and incubated at 28°C for 07 days, the isolates were sub cultured for morphological, cultural and molecular identification, of about 150 fungal endophytic strains were isolated and around 20 identified, many are unidentified, the dominating species is penicillium (48%) species followed by aspergillus (34%) species, the least identified organism was *Taleromyces* species. The isolated endophytic fungal organisms screened for antifungal activity against seven plant pathogenic fungi, i.e. *Aspergillus niger*, *Fusarium oxysporum* strain 4814, *Fusarium oxysporum* 1322, *Fusarium odum*, *Aspergillus flavus*, *Trypophyton rubrum* and *Colletotrichum gleosporioides* by dual culture plates, after showing significant inhibition of plant pathogens, among 49 colonies, 6 of them showed potential inhibition against different plant pathogen. Fungal cultures SA1C1, SA1C2, SB1C1, and SB1C2, inhibited the growth of *Aspergillus niger*. Fungal cultures SA1C2, SA1C3, SA1C4, and SB1C2 inhibited the growth of different *Fusarium* sp. SA1C4 found to be more potential inhibition against 5 different pathogens, Antifungal activity was assessed by measuring the inhibition zone (Paul, et al., 2012). The potential endophytes selected for the isolation of crude antimicrobial compounds by cultured on Petri dishes of potato dextrose agar (PDA) at 28°C for 5 days, the agar patches inoculated into Erlenmeyer flasks (1000 mL), after 20-40 days of incubation at room temperature. Crude compounds were extracted twice with an equal volume of Ethyl acetate and evaporated to dryness and residues were dissolved in dimethyl sulfoxide (DMSO) to give a stock solution (10 mg/mL) for further assays. The fungal endophytes were also screened for their extracellular enzyme activity using standard procedures, the total of 30 isolates, only 10 endophytic fungi showed positive for enzyme activity tests, the ten fungal isolates were screened for production of Lipase, Amylase, Cellulase, Asparaginase, Glutaminase, Xylanase, Pectinase, DNase, and Casein. No endophytes were able to produce Lipase, Asparaginase, Xylanase, and DNase. The fungal isolates named RHIST17 & RHILF5A showed results for production of Amylase. The fungal isolates AVILF9A, RHIST17 & RHILF5A produced Glutaminase, and isolate ACALF17 was able to produce Pectinase, and two isolates named RHIST17 & ACALF17 were able to produce Casein. The potential isolates were isolated genomic DNA and submitted to sequencing for molecular identification.

Keywords: *Avicennia marina*, mangroves, endophytic fungi, antifungal, extracellular enzymes

Progress and Potential of Horticulture Sector in India

Akshay Deep, Sudhakar Dwivedi, Anil Bhat, Lalit Upadhyay, Manmohan Lal

Sher-e-Kashmir, University of Agricultural Sciences and Technology of Jammu

ABSTRACT

Horticulture sector has become one of the major drivers of growth in the Agriculture sector. Horticulture sectors provide employment opportunities across primary, secondary and territory sectors. Horticulture crops particularly fruit crops are relatively resilient to changes in weather conditions. Horticulture sector is recognised to have the potential to raise the farm income, provide livelihood security and earn foreign exchange (Jha et al., 2019). According to Jha et al. (2019) horticultural sector accounts for about 37 per cent of the total exports of agricultural commodities, and the exports has recorded sustained rising trend. India has witnessed increase in horticulture production over the last few years. Production of fruits and vegetables as well as spices has overtaken the production of food grains in the country. Over the last decade, the area under horticulture grew by 2.6 per cent per annum and annual production increased by 4.8 per cent. During 2017-18, production of horticulture crops was 311.71 Million Tonnes from an area of 25.43 Million hectares. The production of vegetables has increased from 101.2 Million tonnes to 184.40 Million tonnes since 2004-05 to 2017-18 and production of fruits has increased from 50.9 Million tonnes to 97.35 Million tonnes since 2004-05 to 2017-18, respectively (Horticulture Statistics, 2018). According to the recent reports of FAO (2018), fruits and vegetables account for nearly 90 per cent of total horticulture production in the country. India is now the second largest producer of fruits and vegetables in the world and is the leader in several horticultural crops viz., Bananas (26.08 %), Papayas (44.05 %) and Mangoes (including mangosteens and guavas) (45.89 %). During 2020-21, India exported fruits and vegetables worth Rs. 9,940.95 crores/ 1,342.14 USD Millions which comprised of fruits worth Rs. 4,971.22 crores/ 674.53 USD Millions and vegetables worth Rs. 4,969.73 crores/ 667.61 USD Millions (APEDA, 2018). Though India's share in the global market is still nearly 1 per cent only, there is increasing acceptance of horticulture produce from the country.

Keywords: Area, production, productivity and horticultural crops

Front line demonstrations on pigeon pea to enhance the production and minimize the yield gap

Mamta Singh¹, A K Singh² and KS Yadav¹

¹Krishi Vigyan Kendra, Sagar

²Krishi Vigyan Kendra, Jabalpur

ABSTRACT

Red gram or pigeon pea is commonly known as Tur or Arhar in India. It is second most important pulse in the country after chickpea. The ability of red gram to produce high economic yield under soil moisture deficit, makes it an important pulse crop in rainfed and dryland agriculture. India contributes for nearly 90 percent of world's total red gram production (Agriculture Market Intelligence centre, PJTSAU, Red gram outlook, February 2018). It is a rich source of protein and supplies a major share of the protein requirement of vegetarian population of the country. Deep roots improve physical properties of the soil and pulverise the soil as the plants shed large number of leaves, this biomass add organic matter to soil. Madhya Pradesh being the major pulse growing state in India, has a lot to contribute towards increasing pulse production and productivity in the country. To boost the production and productivity and to minimize the yield gap of red gram, Krishi Vigyan Kendra Sagar conducted front-line demonstrations at farmer's field. The technology demonstrations were conducted in Rahatgarh, Jaisinagar and Kesli block of Sagar district during 2016-17 to 2018-19. The demonstrations were conducted in an area of 80 ha. against local variety in three years. One hundred ninety-five demonstrations were conducted with active participation of farmers to demonstrated the improved technologies of pigeon pea in different village so as to establish production potential and expand the area under the crop in the district. The farmers practices were considered as control plot in all demonstrations. All inputs based on identified technologies. The data was collected from farmers field on plot basis. It was observed that the yield enhancement from 42 to 88 percent more as compared to farmers practices. The yield enhancement variation was received due to application of improved package and practices with use of high yielding medium duration varieties and improved plant protection measures. Economic analysis showed that net returns was higher than the local check and B:C ratio was 2.16, 3.46 and 2.15 in the year 2016-17, 2017-18 and 2018-19 respectively. The variation in yield was due to variations in rainfall in each year.

Human gut microbiota and its role in immunity

Sneahpreet Kour, Upma Dutta, Brajeshwar Singh, Ashish Sheera

Sher-e-Kashmir University of Agricultural Sciences and Technology of Jammu

ABSTRACT

The gut microbiome is defined as the totality of microorganisms, bacteria, viruses, protozoa, and fungi, and their collective genetic material present in the gastrointestinal tract (GIT). The gut microbiota is comprised of all the bacteria, commensal, and pathogenic, residing in the GIT. The gut microbiota plays an important role in nutrient and mineral absorption, synthesis of enzymes, vitamins and amino acids, and production of short-chain fatty acids (SCFAs). The fermentation byproducts acetate, propionate, and butyrate are important for gut health and provide energy for epithelial cells, enhance epithelial barrier integrity, and provide immunomodulation and protection against pathogens. The human gut microbiota is divided into many groups called phyla which include *Firmicutes*, *Bacteroidetes*, *Actinobacteria*, and *Proteobacteria*. While bacteria colonizes the human body, including oral cavity, placenta, vagina, skin, and GIT, the majority of bacteria reside within the GIT, with the majority of predominantly anaerobic bacteria housed in the colon. The human body expresses 20,000 eukaryotic genes while the gut microbiome expresses 3.3 million prokaryotic genes. The establishment of a gut flora is crucial to the healthy functioning of the gastrointestinal tract. The exact sources of bacteria are not fully understood, but may include the birth canal, parents, siblings, hospital workers, breastmilk, food, and the general environment. It remains unclear however, whether most colonizing arises from the mother or not. It was thought that the GIT of a normal fetus is sterile, however evidence has begun to emerge that bacteria already exists in the intrauterine environment. The microbiota offers many benefits to the host, through a range of physiological functions such as strengthening gut integrity or shaping the intestinal epithelium, harvesting energy, protecting against pathogens and regulating host immunity. However, there is potential for these mechanisms to be disrupted as a result of an altered microbial composition, known as dysbiosis. Role for the microbiota in a large number of intestinal and extra-intestinal diseases has become steadily apparent. Gut microbes are key to many aspects of human health including immune, metabolic and neurobehavioral traits.

Keywords: propionate, *Firmicute*, butyrate, *Bacteroidetes*, *Actinobacteria*, *Proteobacteria*, Short-chain fatty acids (SCFAs)

Factors Affecting Perceived Training Need of Horticulture Extension personnel in Jammu Region of J&K

Arvinder Kumar, S.K Kher*, Lalit Upadhyay, Lobzang Stanzen, Preety Chaudhary

Krishi Vigyan Kendra, Reasi

**Division of Extension Education, Sher-e-Kashmir University of Agricultural Sciences and Technology of Jammu*

ABSTRACT

Transfer of learning is critical to recognizing a positive rate of return, but many experts fail to realize most of the influencing factors are out of the learner’s control. However, whether or not a learner is able to successfully transfer his or her knowledge to the workplace is not wholly dependent upon the learner. Instead there are many different types of influential factors that affect job training, and, in fact, most of them do not depend on the learner. In the present study linear regression model was employed to find out the factors influencing the training need of horticulture extension personnel after collecting the data from 200 horticulture extension personnel) working at gross root level in all ten districts of Jammu region. Eight variables viz age education family background, service length, trainings attended, information utilization sources, information dissemination sources and knowledge were taken to know the effect on training need. It was evident from the study that two factors viz trainings attended and information utilization sources were significantly affecting the training need of the horticulture extension personnel with t-value 2.436 and -2.274, p-value .016 and .024, respectively. This means that extension personnel who had attended trainings desire to attend more other training programme but the extension personnel with high utilization of information sources perceived less training need.

Keywords: Training, Training needs, Learning, Extension personnel

Pattern of Livelihood Diversification of Households in India

Diksha, Sudhakar Dwivedi, Jyoti Kachroo, Akshaydeep

Division of Agricultural Economics and ABM SKUAST Jammu

ABSTRACT

Increase in mechanization in agriculture has decreased the demand of manual labour thus; various non-farm activities serve the purpose of providing the prospects of employment and income to the household and rural work force. The contribution of agriculture to GDP is continuously decreasing which shows the shift of society from farm to non-farm activities. For assessing the economic well-being of individuals and of society as a whole and to assess the effect of both universal and targeted actions (such as welfare, taxation and other fiscal policies) on the socio-economic groups monitoring changes in sources of income and income distribution for population is important. An attempt has been made to study the pattern of livelihood diversification of household in India with a special case of rural population using the secondary data. Trend showed that over a longer period, from 1991 to 2019, employment in agriculture as a percentage of total employed dropped from 63 percent to 43 percent and per capita income is inversely proportional to poverty. Major source of income are agriculture and wages and salaries where farmers with less than 2 hectares of land are found to be wage labourers and those with more than 2 hectares of land are found to be engaged in agriculture thus a decreasing trend in diversification with increase in size of land holding. Number of income sources had positive effect on the income of households. More diverse the source of income, better the income opportunities. Pluriactivity is observed in agricultural households. The shift from agriculture has been mainly to construction, manufacturing and trade and hotels sector. States like Jammu & Kashmir, Himachal Pradesh, Sikkim, Meghalaya, Andhra Pradesh witnessed an increase in non-farm employment with high income and high diversification. The higher educated groups found to move away from agriculture into more of casual labour and less into remittances. So, policies and interventions for creating employment opportunities have to be designed for promoting NFL in a big way along with strengthening the existing institutions.

Keywords: Livelihood diversification, rural economy, pluriactivity, employment

Evaluation of different IPM modules against fruit borer, (*deudorix isocrates*) on aonla (*emblica officinalis*)

Thanlass Norboo*, Uma Shankar, Stanzin Landol, Lalit Upadhyay and Divya Chand

Division of Entomology, Sher-e-Kashmir University of Agriculture Sciences and Technology of Jammu (Jammu & Kashmir), India -180009

ABSTRACT

Study on ‘Evaluation of different IPM modules against fruit borer, *Deudorix isocrates* on aonla, *Emblica officinalis* (Gaert.)’ was conducted at two locations i.e., Dryland Research Station (DRS), Dhiansar, and RHRSS, Raya i.e., of Sher-e-Kashmir University of Agricultural Sciences and Technology of Jammu for two consecutive year during 2016 and 2017. The survey indicated that Fruit borer, *Deudorix isocrates* Fabr. (Lycaenidae: Lepidoptera) were major insect pests on aonla causing significant damage to the fruit production. Evaluation of different modules for the infestation of fruit borer during 2016 showed that the number of infested fruits ranged from 3.25 (M-II) to 23.50 (Untreated control). The infestation observed in module M-I and M-III were found to be 12.75 and 8.50, respectively. Similarly, highest weight of fruits were recorded in M-II (905.25g) followed by M-III (737.50 g) and M-I (685.00 g). The minimum weight of healthy fruits was recorded in untreated control (506.50g). The least percentage infested fruits (by numbers) were observed in M-II (7.00) followed by M-III (24.25) and M-I (36.25). The weight of infested fruits varied from 7.75 g (M-I) to 38.25 g for (Untreated control). The highest percentage reduction over control (by number) were found to be in M-I (86.96) followed by M-III (60.87) and M-I (34.78), respectively. Similar trend was also found on the percentage of infested fruits by weight during 2017. Percentage of infestation was least in the treatments M-II and M-III and the highest percentage of infestation (by Number and weight) was also observed in the untreated control (58.5 % and 41.00 %). The highest percentage reduction over control (by number) were found to be in M-I (82.05) followed by M-III (51.71) and M-I (32.91), respectively. Significant percentage of fruit infestation (by number and weight) due to the damage caused by the aonla fruit borer during 2017.

Keywords: *Emblica officinalis* (Gaert.), *Deudorix Isocrates* Fabr, IPM modules, Production.

Current Status of Plant Genome Editing

Preeti Choudhary, Prerna Johar¹, Lalit Upadhyay, Arvinder Kumar, Lobzang Stanzen

Krishi Vigyan Kendra Reasi

¹*School of Biotechnology, SKUAST-Jammu*

ABSTRACT

Genome-editing tools provide advanced biotechnological techniques that enable the precise and efficient targeted modification of an organism's genome. Genome-editing systems have been utilized in a wide variety of plant species to characterize gene functions and improve agricultural traits. Genome editing is defined as collection of advanced molecular biology techniques that facilitate precise, efficient and targeted modifications at genomic loci. Genome editing or genome editing with engineered nucleases (GEEN) is a type of genetic engineering in which DNA is inserted, replaced or removed from a genome using artificially engineered nucleases or “molecular scissors”. Techniques such as zinc-finger nucleases (ZFNs) and transcription activator-like effector nucleases (TALENs) have been used as genome editing tools for two decades but it has recently come under the spotlight through the development of clustered regularly interspaced short palindromic repeats (CRISPR)/ Cas systems which provide simplicity and ease of targeted gene editing. All of these technologies use typical sequence-specific nucleases (SSNs) that can be induced to recognize specific DNA sequences and to generate double-stranded breaks (DSBs). The plant's endogenous repair systems fix the DSBs either by non-homologous end joining (NHEJ) which can lead to insertion or deletion of nucleotides thereby causing gene knockouts or by homologous recombination (HR) which can cause gene replacements and insertions. Many gene knockout mutants and some gene replacement and insertion mutants have been produced through the use of genome-editing technologies in a wide variety of plants and many of these mutants have been shown to be useful for crop improvement.

Study on pest and disease incidence in tomato under poplar based agroforestry in subtropics of Jammu

Lalit Upadhyay, S. K. Gupta, Sandeep sehgal, Uma Shankar*, Amit Singh*

Division of Agroforestry, SKUAST Jammu

** Division of Entomology, SKUAST Jammu*

ABSTRACT

A study was conducted to assess the performance of different vegetables under poplar based agroforestry system in subtropics of Jammu. Trial was conducted under 5 year's old plantation of poplar, to find out the growth and yield of tomato in *kharif*. All the crop was grown in open as well as under shade of poplar trees with five treatments T1: RDF of NPK, T2: 50%N+50%N through FYM, T3: 100% N through FYM, T4: 50%N+50%N through VC, T5: 100% N through VC. Effect of shade and fertilizers were studied on pest and disease incidence in tomato and the following observations were recorded.

Jassids – In the study, incidence of Jassid (*Amrasca devastans*) was first recorded about 20 days after transplantation in first year. T₁ and T₂ with 18.33% were highly affected among treatments followed by T₃ and T₄ (16.67%). Treatment T₅ (15.00%) was least affected in open. Under shade T₁ treatment was highly affected (23.33%) followed by T₂ and T₃ (both 21.67%). T₅ treatment with 20.00% was least affected. The effect of intercropping was significant.

Fruit borer – First incidence of fruit borer (*Helicoverpa armigera* Hubner) was observed at the age of about 37 days after transplanting in first year. In the open field highest pest incidence was recorded in treatment T₁ (21.67%) followed by T₂ (20.00%). Percent incidence was least in T₅ (16.67). Under tree canopy T₁ treatment showed the highest incidence (20.00%) followed by T₂, T₃, T₄ (all 18.33%). With 16.67%, treatment T₅ was least affected.

Early blight – Early blight of tomato Caused by *Alternaria solani*, was recorded in the first year with 8.33% disease incidence in T₁ followed by T₂ and T₄ (8.33%) in open field. T₁ (10.00%) showed the highest incidence percentage of early blight under tree canopy. Lowest incidence was recorded in treatment T₅ in open (6.67%) as well as under tree canopy (8.33%). Higher percentage of early blight was observed under shade in comparison to open but non-significant variation was observed on the percent incidence of early blight under shade of poplar and fertilizer treatments interaction.

Economic analysis of Kharif vegetables under poplar based agroforestry in subtropics of Jammu

Lalit Upadhyay², S. K. Gupta, Sandeep sehgal, Suresh Ramanan S.¹, Arvinder Kumar²

Division of Agroforestry, SKUAST Jammu

¹CAFRI, Jhansi

²K.V.K. Reasi

ABSTRACT

Two years trial was conducted to study the performance of different vegetables under poplar based agroforestry system in subtropics of Jammu, Jammu and Kashmir at Agroforestry Research Farm, Chatha of Sher-e-Kashmir University of agricultural sciences and technology of Jammu. Trial was conducted under 5 year's old plantation of poplar, to find out the growth and yield of tomato, brinjal, okra in kharif. All the vegetables were grown in open as well as under shade of poplar trees with five treatments T1: RDF of NPK, T2: 50%N+50%N through FYM, T3: 100% N through FYM, T4: 50%N+50%N through VC, T5: 100% N through VC. Under poplar shade, the highest B:C ratio in kharif 2017 was observed in tomato in treatment T1 (0.61). Brinjal was on second place with maximum B:C ratio in T1 (0.40). Okra was at last place with maximum B:C ratio in treatment T1 (-0.17) followed by T2 (-0.41) and T4 (-0.57). Tomato (-0.49), brinjal (-0.58) and okra (-0.72) showed minimum B:C ratio in treatment T5. While evaluating the economics of the whole system (poplar + intercrop) in kharif season the maximum B:C ratio recorded was in brinjal in T1 (2.60) in 2017 and (2.89) in 2018 (Table 3). In tomato, the maximum benefit was in T1 in 2017 and 2018 (2.08 and 2.20 respectively). Whereas, okra was at last place with B:C ratio of 1.60 and 1.70 in 2017 and 2018 respectively in kharif. Lowest B:C ratio was observed in treatment T5 in brinjal, tomato and okra with the value of 0.67, 0.45, 0.45 respectively in 2017 and 0.79, 0.51, 0.50 respectively in kharif 2018.

Keywords: Poplar, Vegetable, Agroforestry, Economics, Subtropics

Importance of feed and fodder for enhancing milk production

Moh Faiz* Moh.Rizwan, Moh. Imran, Ahmad Fahim* and Nazim Ali

S.V.P.University of Agriculture and Technology Modipuram Meerut

ABSTRACT

It was reviewed that Availability of adequate quantity of feed and fodder for livestock is essential for improving the livestock productivity There is a deficit of 23.4% in the availability of dry fodder, 11.24% in that of green fodder and 28.9% for concentrates. which is a “major factor” behind the recent rise in costs of milk production. In a report titled ‘Revisiting National Forage Demand and Availability Scenario, released from Indian Grassland and Fodder Research Institute has pointed to a deficit of up to 29 per cent in the availability of feed, including fodder. According to the report, there is a deficit of 23.4 per cent in the availability of dry fodder, 11.24 per cent in that of green fodder, and 28.9 per cent for concentrates. This means that for every 100 kg required, India is short of 23.4 kg of dry fodder, 11.24 kg of green fodder, and 28.9 kg of concentrates. India, comprises crop residue, for example, the straw left behind after wheat and rice are harvested. Examples of green fodder include forage crops (those grown specifically for grazing), grasses from forests and pastures, and cultivable wastelands. Concentrates are feed mixtures of protein, carbohydrates, and fat that include oilseed cakes and crushed pulses. It's rich in energy-yielding nutrients, unlike crop residue. Emphasising the importance of healthy fodder availability, the report notes that livestock is often the only source of cash income for around 12.6 crore small and marginal farmers as they serve as insurance in the event of crop failure. Government of India has released funds under the Centrally Sponsored Scheme-National Livestock Mission for various components of fodder development both for production and post harvest management, to assist the States in their endeavor to augment the availability of quality feed and fodder. Though the availability of feed and fodder has improved in the last decade, still there exists a substantial gap between the demand and availability of fodder in the country, particularly during the lean periods and at the time of natural calamities including droughts/floods. Following measures may be taken for ensuring maximum availability of fodder for sustaining livestock production: Optimum utilization of land resources . The number of livestock is growing rapidly, but the grazing lands are gradually diminishing due to pressure on land for agricultural and non-agricultural uses. Most of the grazing lands have either been degraded or encroached upon restricting its availability for grazing. The area under fodder cultivation is limited to about 4% of the cropping area, and it has remained static for the last four decades. Owing to the -2- importance of food crops and other cash crops, it is very unlikely that the area under fodder cultivation would increase substantially. Therefore, the need of the time is to adopt the practice of land use

3rd International Conference on “Global Initiative in Agricultural, Forestry and Applied Sciences for Food Security, Environmental Safety and Sustainable Development (GIAFAS-2021)”

with multiple crops in a sustainable manner. Adopting Silvi-pastoral and Horti-pastoral models suitable to the area can help in substantially enhancing the availability of forage for the livestock.

Entrepreneurship Development among Farmers

Jamyang Lahmo* and Stanzin Yangsdon

Division of Agricultural Extension and Education, SKUAST –JAMMU (J&K)

ABSTRACT

The word “entrepreneur” originated from France in the 17th century, when people regarded an entrepreneur as an individual who undertook a particular commercial business. Entrepreneur is therefore the person who exploits potential opportunities to create values creatively and innovatively by imputing limited resources (Wickham 2001). Entrepreneurship has been recognized as an effective means for economic transformation. It is commonly acknowledged that there is a positive correlation between entrepreneurship and economic growth (European Commission, 2006). In present times, when the viability of small and marginal scale farming is dampening due to the rising cost of cultivation, declining market returns and degradation of natural resources, entrepreneurship development in agriculture has become an important area of research investigation as well as policy and development initiative. Before starting the **entrepreneurship development**, it is imperative to set a clear objective and draft a plan as to what the program is aiming to accomplish. As someone who is organising this program, having a clear direction and objectives play an important role in making it a success. Absence of both will result in loss of time, money, effort and most of all, valuable potential of the individual. The entrepreneurship development main purpose is to help aspiring entrepreneurs furnish their talents and learn the intricacies of operating a business. For, this you will require trained professionals who are experienced in this domain and can impart their own life lessons to those who are just starting or facing difficulties. Seek help from established entrepreneurs around you and ask them if they can conduct a session or find those who have pursued a professional qualification in this field and enrol them for the session. Some of the most significant challenges are Market related risk, low bargaining power, delegation of task, Marketing strategy and cash flow management.

Keywords: Entrepreneurship, development, business, farming

Precision farming: Shifting from the conventional farming system

Daripalli Srilakshmi, Subhendu Shekhar Gantait

Bidhan Chandra krishi viswavidyalaya, mohanpur, West Bengal

ABSTRACT

Agriculture, being an interaction of several inputs such as seed, soil, water and agrochemicals, has come to a point where all the inputs used in such complex system are to be used prudently in order to maintain sustainability. Due to total disregard of proper management of such inputs, without considering the effect it has on ecology, has led to degradation of environment. Maximizing the input use efficiency has turned out to be a good alternative without giving an adverse effect. Exploiting of all the advanced tools that utilize the information technology and agricultural sciences is proving to be beneficial in economic and environmentally sustainable crop production. Precision farming has been defined as information and technology based farm management system to identify, analyze and manage spatial and temporal variability within fields for optimum productivity and profitability, sustainability and protection of the land resource by minimizing the production costs. Site specific management is a management that has compelled the growers to modify agricultural management practices by using the right quantity of inputs at the right time and in the right place. The various tools used in SSM such as GIS, remote sensing and GPS have been shown to help in developing a comprehensive management plan that consequently improved the production efficiency with increased yield and with very little adverse effect on the environment. Various advanced equipments such as robots and drones will soon become a part of the site specific management in the near future and drastically change the way of farming.

Antagonistic performance of *Trichoderma spp.* against *Colletotrichum falcatum* causing red rot in sugarcane

Jayant Mandal¹, Anwar Ahmad¹, Ajay Kumar¹ and Sujeet Pratap Singh²

¹*Department of Plant Protection, Ch. Charan Singh University, Meerut.*

²*Uttar Pradesh Council of Sugarcane Research, Shahjahanpur.*

ABSTRACT

Sugarcane is an oldest crop known to man a major crop of tropical and sub tropical region worldwide. Plant disease caused by various fungi may cause significant losses of sugar and alcohol (bio-fuel). Red rot (*Colletotrichum falcatum*) is one of the most dreaded diseases of sugarcane, called "cancer of sugarcane" as it has become major constraint in the profitable cultivation of sugarcane. The disease is mainly managed with resistant genotypes but breakdown of resistance with new pathotype is a recurring problem for red rot management. The present study was conducted in the laboratory. Efficacy of *Trichoderma* against *C. falcatum* was tested in *in vitro* condition. Three species of *Trichoderma* such as *T. harzianum*, *T. viride* and *T. virens* were obtained from Soil microbiology division. *C. falcatum* was isolated from infected cane of red rot. *Trichoderma* isolates against *C. falcatum* was assessed by dual culture technique on OMA medium. Observations of inhibition of mycelial growth and sporulation of the pathogen were recorded on seventh day after inoculation of *Trichoderma* isolates. *Trichoderma* cultures were placed at the opposite end of the Petri dish on OMA. The antagonistic effect of *Trichoderma* was assessed on the basis of pathogen mycelial inhibition on seventh day at 28±2°C. *Trichoderma* isolates were cultured along with *Colletotrichum falcatum* in petriplates for a week and it was found that all the species of *Trichoderma* reduced the mycelial growth of *Colletotrichum falcatum*. Results indicate that all the fungal antagonists inhibited the growth of *C. falcatum*. *Trichoderma harzianum* gave best result in dual culture with minimum radial growth of 10.23 mm and maximum growth inhibition of 88.63% followed by *T.virens* with radial growth of 19.7 mm and growth inhibition of 78.11%, *T.viride* with 21.3 mm growth and 76.30% inhibition. *T. harzianum* antagonists could be use a biocontrol mechanism against *C. falcatum*.

Efficacy of azoxystrobin + difenoconazole against *Colletotrichum falcatum* w. causing red rot in sugarcane

Mohd Irshad¹, Anwar Ahmad¹, Ajay Kumar¹ and Sujeet Pratap Singh²

¹Department of Plant Protection, Ch. Charan Singh University, Meerut

²Uttar Pardesh Council of Sugarcane Research, Shahjahanpur

ABSTRACT

Sugarcane diseases are constraints to crop production all over the world, and no country is protected from the destructive influences of plant pathogens and pests. More than 125 diseases of sugarcane caused by fungi, bacteria, viruses, phytoplasma and nematodes have been reported from all over the world. Red rot caused by *Colletotrichum falcatum*, is a devastating fungal disease posing a serious threat to sugarcane cultivation in India. The present study was conducted in the laboratory of Plant Pathology, efficacy of Azoxystrobin + Difenoconazole against *Colletotrichum falcatum* W. causing red rot in sugarcane. Surface sterilized with 0.1% bleach for approximately 2 minutes then washed three times with distilled water and placed on petri plates having potato dextrose agar (PDA). Petri plates were incubated at 28 ±1°C for one week to check the sporulation for further studies. Single spore technique used for obtaining pure culture by incubating at 28°C for one week and observed it daily to get rid of contamination. Fungicides are specific in their action and specificity for various genus and species. Amistar top fungicide was found effective at 50 and 100 ppm for the suppression of radial growth of two pathotype/isolate of *C. falcatum*. The fungicide evaluated after seven days of colony growth by was taken inhibition percentage of all tested concentrations such as 1, 2, 5, 10, 50 and 100 ppm. Data regarding inhibition percentage of *C. Falcatum* (Cf 08) revealed that Amistar top was the effective fungicide was inhibited mycelial growth at all concentrations. 1 to 100 ppm with inhibition percent of 66.03 to 93.70. Results in current study showed that by increasing concentration of Amistar top. Fungicides can inhabit *C. falcatum* (Cf 08 and Cf 0238) efficiently and can be used for treatment of red rot disease of sugarcane. The controlling of red rot disease such as use of systemic fungicide Amistar top for activation of plant defense system can be used.

Effect of different soil management practices and nitrogen levels on hydrothermal regimes in pea and okra crop in mid hill zone of Himachal Pradesh

Sunil Kumar and M. L Verma

Department of Soil Science and Water Management, Dr YSP UHF Nauni, Solan, HP- 173230

ABSTRACT

The present research conducted on “Effect of different soil management practices and nitrogen levels on hydrothermal regimes in pea and okra crop” were analyzed in Randomized Block Design (Factorial). The field experiments were conducted during rabi 2017-18 and 2018-19 and kharif 2018 and 2019 seasons at the experimental farm, Department of Soil Science & Water Management, Dr. Yashwant Singh Parmar University of Horticulture and Forestry, Nauni, Solan, Himachal Pradesh. The effect of different soil management practices on soil temperature and moisture content was recorded each fortnightly interval at both 0-7.5 and 7.5-15 cm soil depths after applying mulch during both year of crop study (2017-18 and 2018-19 in peas and 2018 and 2019 in okra). The Diurnal soil temperature was recorded two times during a day at 7:30 hrs (minimum temperature) in morning and 14:30 hrs (maximum temperature) in afternoon at 0-10 cm soil depth. The highest moisture content was recorded under black plastic mulch treatments (S2) as compared to all other treatments during both years of study, whereas, the lowest soil moisture contents were recorded under unmulched treatments (S0).

Yield gap analysis through cluster frontline demonstrations in groundnut in Nalgonda district, Telangana state

Shankar, M.^{1*}, Aariff Khan, M.A¹, Bharath, T¹, Pallavi, S¹, Shankaraiah, M¹ and Sumalini, K.²

¹*Krishi Vigyan Kendra, Kampasagar, PJTSAU, Nalgonda Telangana 508 207 India*

²*Agricultural Research Station, Kampasagar, PJTSAU, Nalgonda Telangana 508 207, India*

ABSTRACT

The present study was carried out by Krishi Vigyan Kendra, Kampasagar, Nalgonda districted to assess and analyze the yield gap between improved package of practices under Cluster Frontline Demonstrations (CFLDs) and farmers practice during *Rabi* 2016-17 to 2020-21 in groundnut crop. The results revealed that, the highest average pod yield was recorded in CFLD (2341.6 kg/ha) with 27% higher over to farmers practice (1843.6 kg/ha). The average extension gap (EG), technology gap(TG) and technology index (TI) were 498.0 kg/ha, 658.4 kg/ha and 21.9%, respectively. The average Sustainability Yield Index (0.78) and Sustainability Value Index (0.84) were high in improved practices than farmers practice (0.76 and 0.75) respectively. Similarly, the average gross returns (Rs. 1,28,283.0/ha), net returns (Rs.71,934.0/ha) and Benefit Cost ratio (2.6:1) were higher in improved practice when compared to farmers practice. The mean of additional gross returns (Rs. 24,873.0/ha), cost of cultivation (Rs. 4,151.0/ha), net returns (Rs. 28,402.0/ha) with incremental BC ratio 6.0:1 was observed in improved practice. The average yield gap percentages within district and state averages were 64.2% and 45.6%, respectively. The per cent increased horizontal spread of area under groundnut was 14.1%, 23.9% and 27.5% during 2017-18, 2019-20 and 2020-21, respectively, whereas in 2016-17 and 2018-19 per cent horizontal spread area decreased to -52.3% and -15.9% with cultivation of improved varieties i.e. K-9 and ICGV 3043 against old traditional varieties (K-6 and TAG 24).

Keywords: Groundnut, CFLD, Yield gap analysis, Sustainability yield index, Sustainability value index, Economics

Teff- a super millet crop

Ashoka P*, Mahantesh B. Nagangoudar and Sunitha N H

ICAR-KVK, (University of Agricultural Sciences, Dharwad)- Haveri -581115

ABSTRACT

Major cereals viz., rice, maize, wheat, etc., though capable of meeting food demands, require major concern in their production with high demand for external inputs. Continuous consumption of these crops is inviting many health issues as they are capable of supplying limited nutrition. Though, minor millets are being cultivated since ages in India as integral part of sustainable farming for their high nutritiousness, yet the value they fetch in the market is too low for a grower to lead a comfortable life. This is creating a wider socio-economic gap between the poor farmers and commercial farmers. Hence, there is an urgent need for a crop that not only suffice the hunger with high

nutritional quality but, must have a higher demand in the market. Teff is one such minor millet native of Ethiopia where it is cultivated and consumed as staple food for about 50 percent population of the country. It is an intriguing grain, rich in nutrition compared to other cereals and is free of gluten and capable of yielding potentially even on marginal soils. Teff was introduced to India by CFTRI, Mysore. Teff seeds are the smallest seeds in the world, varying in 1-1.7 mm long and 0.6-1 mm diameter and 1000 seed weight measuring around 0.3-0.4 grams (weight of 150 teff grains = 1 wheat grain) (Miller, 2007). The seeds are mucilaginous with various seed coat colour viz., ivory, light tan to deep brown or dark reddish-brown purple, depending on the variety (upper class consumed the lighter grains while, the dark grain was the food of soldiers and servants). Majorly three types of seeds are available viz., White teff: Grows only in highlands, when used increases shelf life of injera, chestnut-like flavor and mostly preferred by the higher-class people. Red/Brown teff: More adoptability, earthier and taste more like hazelnuts and mostly preferred by poor and working community. The promotion and cultivation of Teff in India is still in infant stage as less is known about the crop and lack of any standard/improved practices available for its cultivation. The present article is a brief review of the importance and agronomic practices of teff crop in a view to promote the cultivation and consumption of teff in India.

Impact of Organic Agriculture as a Climate Change Mitigation Strategy

Ashoka P, Mahantesh B. Nagangoudar and Priya P

ICAR-KVK, (University of Agricultural Sciences, Dharwad)- Haveri -581 115

ABSTRACT

Organic agriculture, as an adaptation strategy to climate change and variability, is a concrete and promising option for rural communities and has additional potential as a mitigation strategy. Mitigation based on organic agriculture can build on well established practice because organic agriculture is a sustainable livelihood strategy with decades of use in several climate zones and under a wide range of specific local conditions. The careful management of nutrients and carbon sequestration in soils are significant contributors in adaptation and mitigation. It as a mitigation strategy may address both emissions avoidance and carbon sequestration. The first is achieved through Lower N₂O emissions (due to lower nitrogen input)—it is usually assumed that 2 percent of the nitrogen applied to farming systems is emitted as N₂O, irrespective of the form of the nitrogen input. The default value currently used by the IPCC is 1.25 percent, but newer research finds considerably lower values, such as for semiarid areas. Less CO₂ emissions through erosion (due to better soil structure and more plant cover)—there usually is less erosion in organic farming systems than in conventional ones. Lower CO₂ emissions from farming system inputs (pesticides and fertilizers produced using fossil fuel). The highest mitigation potential of organic farming lies in carbon sequestration in soils and in reduced clearing of primary ecosystems. Soil carbon sequestration is used to describe both natural and deliberate processes by which CO₂ is either removed from the atmosphere or diverted from emission sources and stored in the oceans, terrestrial environments (vegetation, soils and sediments). It is greatly enhanced through agricultural management practices (such as increased application of organic manures, conservation tillage, cover crops, nutrient management, irrigation, restoring degraded soils, pasture management, soil use of intercrops and green manures. which The FAO Should play a leading role in this process, including the establishment of this process, including the establishment of a global soil carbon sequestration initiative, entrusted with the promotion of agricultural technologies that restore carbon pools and soil quality (e.g. organic agriculture, conservation agriculture) and to create tools to measure, monitor and verify soil-carbon pools and fluxes of greenhouse gas emissions (viz. nitrous oxide) from agricultural soils, including crop lands and pastures.

Fertigation-A Tool for efficient fertilizer and water management in crops

Ashoka P*, Priya P. and Mahantesh B. Nagangoudar

ICAR-KVK, (University of Agricultural Sciences, Dharwad)- Haveri -581 115

ABSTRACT

Considering the importance of drip method of irrigation in the sustainable use of irrigation water, efforts are being made to propagate the adoption of DIM from 1970 onwards in India (INCID, 1994). It provides efficiently in providing irrigation water and nutrients to the roots of plants, while maintaining high yield production. Modern drip irrigation has arguably become the world's most valued innovation in agriculture since the invention of the impact sprinkler, which replaced flood irrigation. This is because high water application efficiencies are often possible with drip irrigation, since there is reduced surface evaporation, less surface runoff, as well as minimal deep percolation. Moreover, a drip irrigation system can easily be used for fertigation, through which crop nutrient requirements can

3rd International Conference on “Global Initiative in Agricultural, Forestry and Applied Sciences for Food Security, Environmental Safety and Sustainable Development (GIAFAS-2021)”

be met accurately. Due to the way the water is applied in a drip system, traditional surface applications of timed-release fertilizer are sometimes ineffective, so drip systems often mix liquid fertilizer with the irrigation water. Drip irrigation has the greatest potential for the efficient use of water and fertilizers. The limited area of wetting under trickle irrigation reduces the active root zone and also the foraging area of plants to draw water and nutrients from the soil. For minimizing the cost of irrigation and fertilizers, adoption of drip irrigation with fertigation is essential which will maximize the nutrient uptake, while using minimum amount of water and fertilizer. Fertigation gives advantages such as higher use efficiency of water and fertilizer, minimum losses of N due to leaching, supplying nutrients directly to root zone in available forms, control of nutrient concentration in soil solution and saving in application cost. Thus, fertigation becomes prerogative for increasing the yield of most of the crops under drip irrigation.

Keywords: Drip irrigation, Fertigation, WUE and Crops

Micro irrigation Technologies for Contribute to Water Productivity and yield production in Indian Agriculture

Ashoka P*, Priya P and Mahantesh B. Nagangoudar

ICAR-KVK, (University of Agricultural Sciences, Dharwad)- Haveri -581 115

ABSTRACT

India is the largest freshwater user in the world, and the country's total water use is greater than any other continent. Water is the most crucial input for agricultural production. Globally, agriculture accounts for more than 80% of all freshwater used by humans, most of that is for crop production. Currently most of the water used to grow crops is derived from rainfed soil moisture, with non-irrigated agriculture accounting for about 60% of production in developing countries. Though irrigation provides only 10% of agricultural water use and covers just around 20% of the cropland, it can vastly increase crop yields, improve food security and contribute about 40% of total food production since productivity of irrigated land is almost three times higher than that of rainfed land. The Food and Agriculture Organization has predicted a net expansion of irrigated land of about 45 million hectares in 93 developing countries (for a total of 242 million hectares in 2030) and projected that water withdrawals by the agriculture sector will increase by about 14% during 2000 – 2030 to meet food demand (FAO, 2012). Agriculture sector in India has been and is likely to remain the major consumer of water but the share of water allocated to irrigation is likely to decrease by 10 – 15 per cent in the next two decades. Micro irrigation (MI) methods like drip and sprinklers need to be employed for efficient distribution and application of water for crop production. Drip and sprinkler irrigation is a solution that reduces conveyance and distribution losses and allows higher water use efficiency. Drip irrigation has the greatest potential for the efficient use of water and fertilizers through fertigation. Hence, this present study was undertaken to examine the yield of using different irrigation and fertigation schedules by drip irrigation and to suggest the most efficient irrigation. Comparison of normal furrow irrigation efficiencies with sprinkler method with mulch and without mulch yield of maize was noted. Both the efficiencies i.e., water application and water use efficiency.

A comparative study on long term use of various nutrient sources and its effect on soil health and crop production in different cropping systems: A review

Rewangini Ranjha, Sunil Kumar, Rajpaul Sharma and Naveen Datt

CSK Himachal Pradesh KrishiVishvavidyalaya Palampur H.P 176062

ABSTRACT

To meet the food demands of rising human population, intense application of fertilizers is required to enhance the production of food crops. But from past few decades continuous high use of chemical fertilizers are deteriorating the soil health, resulted decreasing in crop productivity. The organic fertilizers alone or in combination with chemical fertilizers are not used by farmers' under long term application may be leads to decline soil health as well as crop productivity. In this review, authors have been tried to compile the information on effect of organic and inorganic sources on soil health and productivity of crops in different cropping cycles under various ecological zone of country. AICRP on long term fertilizer experiments conducted since 1971 in different AUs of country with continuous use of different nutrient sources and amendments to know the significance effect of long term fertilizers and amendments on soil health and productivity under different cropping systems at various ecological zones. In those long term experiments, various treatment combinations were used as per location requirements to assess the

3rd International Conference on “Global Initiative in Agricultural, Forestry and Applied Sciences for Food Security, Environmental Safety and Sustainable Development (GIAFAS-2021)”

sustainable crop production, identified the appropriate soil management practices and make changes in managements according to positive and negative results. Thus, according to peer review by authors in this article revealed that, the combined use of organic and inorganic fertilizers resulted significant improvement in soil health i.e. SOC, pH, Bulk density and available N,P,K, micronutrients, and enhanced crop yield in various cropping cycles i.e. Maize –wheat, Rice-rice, Rice-wheat, Soybean-wheat, Groundnut-wheat, Finger millet-maize, Rice-wheat-jute fibre and sorghum-wheat, under different ecological locations.

Keywords: LTFE, Organic & Inorganic fertilizers, Yield, Cropping system, Ecological zone, Soil health

A Study on Impact of family size on Nutritional Status of Primary School Children

Ankita Tyagi

Govt Women PG College, Kandhla, Shamli

ABSTRACT

Primary School Children constitute a large segment of child population and the size of family has been seen to be positively correlated with the prevalence of malnutrition and infection among the children who belong to low socio economic status. The aim of this study was to examine the impact of family size on nutritional status of Primary School (PS) Children. The study was carried out on 150 children selected using random sampling technique from three different schools of high, middle and low educational standards and expenses (50 from each school). The family size of three different groups was estimated by using interview method and by filling proformas. Nutritional status of PS children was conducted by dietary survey, twenty four hour recall method, food frequency questionnaire and weighment method while anthropometric measurements of PS children were done by using anthropometric rod for height, weighing scale for weight, zerfas tape for Mid Upper Arm Circumference (MUAC) and Harper's caliper for Skin fold thickness. Clinical survey of PS children showed the physical presence of signs and symptoms of nutrient deficiencies and any malnutrition. Statistical procedures viz., percentage, mean, correlation coefficient and standard deviation were used. The result indicated that the nutritional status of Primary School (PS) children is significantly by family size.

Keywords: family size, anthropometric status, dietary survey, clinical signs and symptoms

Biofertilizer and their effects on quality of human life

Khushboo Dubey

College of Agriculture Sciences, Teerthanker Mahaveer University, Moradabad

ABSTRACT

The fertilizers are used to improve the fertility of the land using biological wastes, hence the term biofertilizers, and biological wastes do not contain any chemicals which are detrimental to the living soil. They are extremely beneficial in enriching the soil with those micro-organisms, which produce organic nutrients for the soil and help combat diseases. The farm produce does not contain traces of hazardous and poisonous materials. Thus those products are accepted across the world as Organic ones. Hence for organic farming the use of biofertilizers is mandatory. Biological fertilization techniques are pertinent strategies for an efficient and rational use of agricultural resources with minimal generation of adverse environmental impacts that may affect water resources, ecosystems or the quality of human life. In addition, biological fertilizers provide a wide range of possibilities for the development of conservative agriculture (CA) in different geographic, economic, and cultural backgrounds. Current researches clearly show that biofertilization techniques require less chemical inputs on the soil and facilitate the incorporation of residues that would otherwise go to dumping sites and landfills, which represents relevant reductions on the environmental impacts associated to agriculture activities globally. Limitations of biological fertilization require future research focused on identifying the options available to tackle the issues and offer valid frameworks for development of environmentally friendly practices around the world that allows improvements on the efficiency and consequent supply of product for the industry in the global economies.

Although several options for application of feasibility studies should be carried out by effectively select the best option that offers minimizing environmental impacts. Bio solids, animal manures, green manures, composting, microbial inoculants and seaweeds extracts are techniques widely used in today's agriculture, however, their implementation still requires research, investment, and technological development to fully understand their impacts on the soil, flora, fauna and, ultimately, on human health.

Fungicides and their effects on quality of human life

Khushboo Dubey

College of Agriculture Sciences, Teerthanker Mahaveer University, Moradabad

ABSTRACT

Fungicides are pesticides that kill or prevent the growth of fungi and their spores. They can be used to control fungi that damage plants, including rusts, mildews and blights. They might also be used to control mold and mildew in other settings. Fungicides work in a variety of ways, but most of them damage fungal cell membranes or interfere with energy production within fungal cells. Fungicides can be classified a number of different ways, including (1) mobility in the plant, (2) role in protection of plants, (3) breadth of activity, (4) mode of action, and (5) chemical group. Certain fungicides, usually systemic, have very specific modes of action and are said to be at risk to the development of resistance. May bind to a very specific chemical within the fungus or disrupt one specific step required for the reaction. If the fungus has an alternate pathway to complete the reaction, can break down the fungicide or prevents the chemical from acting in the fungus, then the fungus is resistant to that fungicide. It is generally accepted that there is a great deal of variation within populations of fungi and a few individuals in the population naturally are resistant to certain types of chemicals. When the chemical is used, it kills almost all of the sensitive individuals in the population but the survivors are those few individuals resistant to the action of the chemical. The survivors give rise to the next generation and most of that generation is resistant to the chemical. If fungicide resistance is confirmed or highly suspected, diverse approaches to managing resistance need to be incorporated into disease management strategies immediately for the species.

Nutritional and Pharmacological Properties of Underutilized Fruit *Grewia asiatica*

Ena Gupta¹ and Neelesh Kumar Maurya²

¹Department of Family and Community Sciences, University of Allahabad, Prayagraj, Uttar Pradesh 211002

²Institute of Home Science, Bundelkhand University, Jhansi (U.P.), India

ABSTRACT

There are quite a large number of indigenous and underutilized fruit crops, which are being used by the local inhabitants. In fact for people living in villages, these underutilized fruits are the only source of protective food to meet their vitamins and minerals requirements in their poor diet. Because of their curative properties, these fruits have been used in Indian systems of medicine such as Ayurvedic and Unani since time immemorial. Apart from their nutritive and medicinal values quite a few of these underutilized fruits have excellent flavour and very attractive colour. *Grewia* is a genus of approximately 150 species of family Tiliaceae which include small trees and shrubs, distributed in subtropical and tropical regions of the world. Different species of *Grewia* are small trees that grow to 4 meters or more in height and are found in India, South Africa, Pakistan, Southeast Asia and the USA etc. Fruit of *Grewia asiatica* is a useful source of food, fibre and a range of traditional medicines which cure several diseases and it is a rich source of carbohydrates, vitamins, antioxidants and minerals which are essential for an active and healthy life. *Grewia asiatica* shows a significant antioxidant, antimicrobial, antihyperglycemic, analgesic, antipyretic, anticancer and anti-inflammatory activity. The current overview of *Grewia asiatica* fruit mainly emphasizes nutritional and pharmacological properties and its impact on the betterment of human health wellness.

Keywords: *Grewia asiatica*, nutritional, pharmacological, underutilized.

Review of Sesame's Nutraceutical Importance

Pinki Singh¹ and Neelesh Kumar Maurya²

¹T R Y S PG College moth Jhansi (U.P.), India

²Institute of Home Science, Bundelkhand University, Jhansi (U.P.), India

ABSTRACT

Oil crops including sesame, Brassica, and *Olea europaea* have been valued for their nutritional, medicinal, and culinary characteristics for over 5000 years. *Sesamum indicum* L., an annual plant, is an important oil crop belonging to the Pedaliaceae family. The world's largest sesame producers are India and China. Sesame oil concentration ranges from 28% to 59%. Sesame oil contains lignans, which are natural antioxidants that enhance flavors and taste while extending food shelf life. Sesame seed is high in protein. They are used to make flour, bread and cakes. Sesame oil is used in salads and cooking. Ayurveda uses sesame oil for medicinal purposes. Sesame

3rd International Conference on “Global Initiative in Agricultural, Forestry and Applied Sciences for Food Security, Environmental Safety and Sustainable Development (GIAFAS-2021)”

contains many nutrients including proteins, carbs, antioxidants, lignans, tocopherols, and other micronutrients. This mysterious plant has anticancer, antioxidant, anti-immunoregulation, and anti-hypersensitivity effects. Sesame oil's high PUFA content lowers blood cholesterol, lowers blood pressure, and helps against atherosclerosis, heart disease, and cancer. Sesamin and sesamol, which are found in sesame, help decrease cholesterol and lower blood pressure. Sesame oil supports HDL and LDL cholesterol. Sesame seed possesses antibacterial, anti-inflammatory, anti-diabetic, and antifungal properties. Sesame's contribution to the food and health industries is measurable due to its unsaturated fatty acid and sulphur amino acid content. Varieties of sesame seeds are available worldwide. They are observed growing all throughout the world, with India being one of the largest producers. Simple solvent extraction and expulsion methods can extract the oil from this seed. Alternatively, supercritical extraction is now possible. Sesame, a powerful medication, has the ability to cure numerous diseases. . This study provides a holistic overview of sesame, its qualities, and its significance in many aspects of the base of information.

Keywords: sesame, anticancer, antioxidant, blood pressure, dermatological diseases

Prevalence of eating disorder in adolescent girls

Pooja Devi and Pratibha Arya

Institute of Home Science, Bundelkhand University Jhansi (U.P.)

ABSTRACT

Eating disorders are more common among specific groups of people who are concerned with fitness or personal appearance. There is a widely-held misunderstanding that eating disorders are the result of choice in the way of life. Eating disorders are genuinely significant and frequently fatal illnesses characterized by substantial disruptions in people's eating behaviours and their thoughts and feelings surrounding their eating. It is possible to have an eating disorder if preoccupied with food, body weight, or shape. Binge eating disorder, Bulimia Nervosa, and anorexia nervosa, which is less prevalent but extremely dangerous, are all eating disorders that affect adults and children. Adolescence is a period in which eating problems and disordered eating first appear. The questionnaire, as well as the interview approach, are used in this study. 52% of young females compare their body sizes, weight, and clothing with those of other young females, indicating that they are dissatisfied with their body image and wish to appear more attractive. Only 48% of young females do not compare their body sizes and weight with other young ladies. Seventy-two percent of adolescent females prioritize regulating their hunger, which hurts their appetite, eating behaviours, and behavioural patterns. According to this study, twenty-eight percent of adolescent females aren't pleased with their appetite or eating habits.

Keywords: eating disorders, bulimia nervosa, anorexia nervosa.

Bioactive compounds in fruits and their health benefits

Latika Yadav¹ and Neelesh Kumar Maurya²

¹*Government Degree College, Punwarka, Saharanpur, (U.P.), India.*

²*Department of Food and Nutrition, Institute of Home Science, Bundelkhand University, Jhansi (U.P.), India.*

ABSTRACT

Bioactive substances are food ingredients that have an effect on the physiological or cellular activity of humans. They have a significant direct and indirect impact on human health, as well as extensive therapeutic characteristics. Flavonoids, anthocyanins, tannins, betalains, carotenoids, plant sterols, and glucosinolates are only a few of them. They're typically present in fruits and vegetables, and their therapeutic effects make them appealing candidates for producing innovative functional foods with possible preventative and preservation properties. Fruits are high in nutrition and energy, as well as vitamins, minerals, fibre, and a variety of other physiologically active components. Furthermore, parts of fruit crops such as fruit peels, leaves, and barks have medicinal properties such as antidiabetic, anticancer, antihypertensive, neuroprotective, anti-inflammatory, antioxidant, antimicrobial, antiviral, immune system stimulation, cell detoxification, cholesterol synthesis, anticonvulsant and their ability to lower blood pressure. Fruit species are popular and frequently consumed over the globe. A high fruit diet is linked to a lower risk of chronic disease, according to epidemiological studies. Fruit consumption may help to reduce or prevent chronic diseases due to a range of biological factors.

Keywords: Bioactive substances, fruits, therapeutic, medicinal properties.

GIS approach in mapping potential upland fisheries resources of Anjaw district in Eastern Himalayas

Deepjyoti Baruah^{1*}, P.A. Ahmad², Ravindra Posti², Kishor Kunal², Garima² and P.K. Pandey²

¹ICAR-Indian Agricultural Research Institute, Dirpai Chapori, Gogamukh-787034, Dhemaji, Assam

²ICAR-Directorate of Coldwater Fisheries Research, Bhimtal-263136, Nainital, Uttarakhand

ABSTRACT

The Anjaw district of Arunachal Pradesh situated in the Eastern Himalayas bordering China and Myanmar in its northern side covers an area of approximately 5841.61km² and is bestowed with numerous perennial snow-fed river valleys, high altitudinal lakes and home to indigenous fish species of economic importance. Spatial assessment of these aquatic resources using ArcGIS v 10.7, Erdas 9, LISS-III, Quick Bird, Aster resolution, Toposheets and Shape files to understand the range of land use pattern affecting their distribution support to the decision context in framing strategies and developing action plans for coldwater fisheries improvement in this hill locked district of Arunachal Pradesh. The basic morphometry of the aquatic resources reveals that the river Lohit is the major river drainage system along with its key tributaries Delei and Tellu having a combined length of 4671.45 km. The first order streams accounts 2825 in numbers (2358.40 km length) followed by second-order (1220 numbers, 1134.11 km length), third-order (150 numbers, 690.21 km), fourth order (24 numbers, 249.47 km), fifth-order (5 number, 167.42 km) and sixth-order (1 number, 71.76 km). The upland lakes are 554 in numbers and cover an area of 2484.36 ha. The upland lakes situated under the altitudinal regime of 4000-5000m MSL is 352 numbers (1403.75 ha); under 3000-4000m MSL is 200 numbers (1080.27 ha) and under 2000-3000m MSL is 2 numbers (0.35 ha). The minimum and maximum size of these upland lakes is 0.01 ha and 62.13 ha respectively. The road buffer analysis showed 7 numbers of the upland lakes covering 38.37 ha area are within the range of 1-3 km, 7 upland lakes covering 61.75 ha within 3-5 km, 55 numbers of upland lakes covering 328.9 ha within 5-10 km, 418 numbers of upland lakes covering 1731.04 ha within 10-30 km and 67 numbers of upland lakes covering 324.31 ha within 30-50 km. The Land Use Land Cover classified for the district shows forest covers 69.97% of the total area followed with snow area (20.23 %), wasteland (7.82%), shifting cultivation (1.01%), and human habitation, agricultural land, grassland and water bodies below 1%. The slope class shows 12.91% of the area falls under 0-20 degree as compared to 52.22% for 20-40 degree and 34.87% for above 40 degree. Furthermore, the DEM infers the elevation class between 2000-5000m height encompasses 96.91% of the total area can provide suitable sites for undertaking trout farming activities provided the other conditions are conducive whereas 3.09% area below 2000m elevation may be considered for tropical fish farming. Based on these selected input feature classes being superimposed, the high potentiality for trout fish farming covers an area of 1.03 km² in the slope range of 0-10 degree and moderate suitability in an area of 4.46 km² within the slope range of 10-20 degree in the district of Anjaw.

Keywords: Coldwater, spatial, assessment, resources and Arunachal

Conservation of natural resources and their management through tribal women participation in protected areas of central India

Poonam Xess and Garima Tiwari

Department of forestry, Guru Ghasidas Vishwavidyalaya, Bilaspur (C.G)

ABSTRACT

Protected area contributes to conserve the natural resources present in the forest and tribal women play a crucial role in the sustainable utilization of the natural resources. Protected areas directly conserve the resources or species present in the ecosystem through in-situ conservation. According to IUCN category VI protected area with sustainable use of natural resources contribute mainly to local communities and indigenous people depending on natural resources. We have conducted our research in protected areas of central India. We have studied, reviewed and analyzed various research papers, articles and government data. Therefore analyzing the data tribal women are active participation for natural resource conservation and their involvement could increase effective conservation and management of natural resources in protected areas. In the site where tribal women, SHGs are active the various natural resource can be conserve and manage directly or indirectly. Such efforts of tribal women can conserve and manage the natural resources of protected areas.

Impact of Krishi Vigyan Kendra Dehradun on Women Empowerment: A Study

Kiran pant, A. K. Sharma, Pravin Kumar

KVK Dhakrani, Dehradun, GBPUAT, Pantnagar

ABSTRACT

Krishi Vigyan Kendra (KVK) that provides vocational training to the rural women for making them self-dependent which ultimately help to empower them. KVK Dehradun was established in the year 2004 and its functioning started in the year 2005. Since its inception this KVKs is performing multidimensional roles, starting from core activities such as technology backstopping, introduction of cutting-edge techniques, and up-scaling at one end, and envisioning entrepreneurial opportunities in rural areas, providing vocational/skill training to rural youth, women folks on the other end. Time and again, there were empirical evidences to prove that the KVK System has positively impacted the quality of life of farming community in terms of income, yield, productivity, and above all capacity for optimal utilization of resources etc. To study the role of KVK Dehradun in empowerment of rural women a study was undertaken by collecting comprehensive data for the last 5 year (2015-2020). The primary data were collected with the help of interview schedule from those trainees who participated in any of the programmes conducted for the farmers, and annual, quarterly and other reports served as the secondary source for data collection. The responses so gathered and training was found as the most popular method of knowledge gain where 97.5 percent stated that they gained knowledge followed by field visits (90.00%) and Demonstrations (77.50%), regarding skill development majority of the trainees (80.00%) gained skill in Jute bag making followed by candle making (72.50%), post harvest technologies in fruits and vegetables(71.25%) and packaging (55.00%) simultaneously. Majority of the members of SHG (70 %) stated their knowledge and skill developed after getting vocational trainings from KVKs. Majority of the members were having training exposure (78 %) and membership of their SHG was in between 10-15 years (92%).

Keywords: KVK, Empowerment, Knowledge, Skill, SHG

Effect of Pruning Intensity in Apple (*Malus domestica*) Under Lower Hills of Uttarakhand

Zahid Rehman^{*}, Dr Suneeta Singh¹ and Dr Anil Kumar Saxena²

¹*Department of Horticulture, School of Agricultural Sciences, SGRR University, Dehradun- 248 001, Uttarakhand, INDIA*

²*Department of Soil Science, School of Agricultural Sciences, SGRR University, Dehradun- 248 001, Uttarakhand, INDIA*

ABSTRACT

The present investigation was planned and conducted during 2020-21 at Temperate Orchard of Horticulture Research block, School of Agriculture Sciences, SGRR University, Dehradun, Uttarakhand, India to investigate "Effect of different pruning intensities in Apple (*Malus domestica*) under lower hills of Uttarakhand". The experiment was laid out in randomized block design with three replications and five treatments. The treatments comprised Control i.e. No Pruning, (0% pruning intensity), 1/4 heading back and thinning out (30% pruning intensity), 1/2 heading back and thinning out (50% pruning intensity), 3/4 heading back and thinning out (70% pruning intensity) and No heading back only thinning out, (100% pruning intensity). The experiment was conducted on well-established six year old plants of apple cultivar ‘Tropical Beauty’. Observations on various growth and yield attributes were recorded. The result revealed that treatment T4 (100% pruning intensity) found to be the most effective treatment found to be beneficial for vegetative characters viz, plant height (cm), Number of leaves, Length of leaves (cm), Width of leaves (cm), stem girth (cm) and yield attributes. From economic yield point of view treatment T3 (70% pruning intensity) found to be profitable as compared to rest of treatments.

Keywords: Pruning intensity, heading back, thinning out, apple, plant height

Impact and approach of front line demonstration of Lentil (*Lens culinaris medik.*) Crop in Saran district, Bihar

Surendra Prasad^{*}, R. K. Jha, A. K. Singh, Vijay Kumar, Pankaj Kumar, S. S. Patel And J. C. Chandola

Krishi Vigyan Kendra, Manjhi, Saran, Dr. Rajendra Prasad Central Agricultural University, Pusa, Bihar

ABSTRACT

3rd International Conference on “Global Initiative in Agricultural, Forestry and Applied Sciences for Food Security, Environmental Safety and Sustainable Development (GIAFAS-2021)”

The conducted front line demonstration (FLD) on lentil (*Lens culinaris* Medik.) crop in Saran during Rabi season 2010-11 to 2012-13. The main focused on increased productivity and replacement of old variety and adaptation of new high yielding improved variety KLS-218. The data revealed that whole season these variety was superior over traditional variety use by farmer's practices. The average of three years data observed lentil yield 11.96q/ha by used of production technologies on high yielding variety and local farmer's variety 08.84 q/ha. The performance of this variety was increased 35.12% over farmer's variety. The economic and yield influence of lentil by production technology over farmer's practices i.e. benefit cost ratio (2.91:1) over farmer's practices (2.22:1) and technology gap (3.04q/ha), extension gap (3.12 q/ha) and technology index (20.29%). During this period were significant increased in knowledge level of farmer's.

Keywords: Front line Demonstration, Lentil, Pulses, yield gap and B:C ratio.

Effect of irrigation scheduling on yield and water use efficiency on brinjal (*Solanum melongena*) under drip system

Ram Kumar¹, P V Singh² and Richa khanna¹

¹Department of Agricultural Sciences and Engineering, SET, IFTM University, Moradabad

²GB Pant University of Agriculture and Technology, Pantnagar (U S Nagar) Uttrakhand

ABSTRACT

The drip irrigation is an irrigation method that saves water by allowing water to the directly roots of plants. Though, India has the largest irrigation network, the irrigation efficiency does not exceed 40%. The average rainfall in Uttar Pradesh is 650 mm as against the average rainfall of 1190 mm in the country. Due to water scarcity, the available water resources should be very effectively utilized through water saving irrigation technics. Diversification of cropping pattern particularly in favorable of vegetable crops is becoming popular among farmers because vegetables are most important component in a balanced diet. But diversification of area from field crops to olericulture to meet the demand is not desirable. The maximum yield of crop 900 gm/plant and minimum of yield 620 gm/plant and total yield 51270 gm (54.270 kg). Among the drip irrigation levels, the highest field water use efficiency (6245.31kg ha⁻¹ cm⁻¹) was found at 65% irrigation level, indicating comparatively more efficient use of irrigation water with a possibility of water saving of 35% water by adopting brinjal plot (1.60 litre plant⁻¹day⁻¹).

Keywords: Crop yield, Water Use Efficiency, Drip Irrigation Systems

Mycoremediation through dual high-efficient absorptive removal and degradation of benzidine-based carcinogenic Congo red dye containing wastewater by *Penicillium crustosum* PWWS-6

Barkha Sharma*, Shalini Tiwari, Lakshmi Tewari

Department of Microbiology, College of Basic Sciences & Humanities, G. B. Pant University of Agriculture & Technology, Pantnagar, Uttarakhand, India

ABSTRACT

Dye and dyestuff had a worldwide market of around US \$ 5.7 billion in 2018 with 7% contribution of Indian dye stuff industry. Considering hazardous effects posed by extremely carcinogenic synthetic industrial di-azo dye Congo red (CR) to public health and environment, the study was aimed to provide an ecofriendly mycoremedial process for rapid dye removal. Through simultaneous isolation and screening of native microbial isolates, a filamentous fungus isolated from veterinary medical waste dump *Penicillium crustosum* PWWS-6 was identified as potential dye decolorizing bioagent. Spectrophotometric analysis of decolorized synthetic wastewater revealed faster decolorization (81% in 24 h) compared to previous studies. The bioprocess involved dye biosorption and enzymatic degradation. The one factor at a time (OFAT) and response surface methodology (RSM) were adopted to optimize the cultural parameters. Higher decolorization (99.8%) was achieved in shorter time (16h) under optimized conditions with 100 ppm dye, 6 discs at 27°C. CR degradation products showed less phytotoxicity against *Cicer arietinum* compared to untreated CR. The study explores veterinary medical waste inhabiting *Penicillium crustosum* PWWS-6 as a rapid dye degrading agent.

Effect of indigenous microbial population upon degradation of profenofos, cypermethrin and chlorpyrifos and yield of rice

Harshita Singh, Anita Sharma and MC Singh¹

Department of Microbiology, GB Pant University of Agriculture & Technology, Pantnagar, UK
¹ICAR-National Bureau of Plant Genetic Resources, New Delhi

ABSTRACT

In order to study the effect of fertilizer nutrients (N, P, K) and soil microbial population on pesticides (Profenofos, Chlorpyrifos and Cypermethrin), uptake of these nutrients and yield of rice, a field experiment was conducted during kharif season of 2019 and 2020 at ICAR-Indian Agricultural Research Institute, New Delhi. Although in general, the microbe extracted from soil named H₂B had a marked effect on degradation of pesticides. However, H₂B showed greater effect against profenofos as compared to cypermethrin and chlorpyrifos. Application of N, P, K significantly increased the uptake of these nutrients and plants at various growth stages on other hand, none of the pesticides could show any marked effect on the uptake of these nutrients. The highest grain yield was recorded, when half of N and K together with full dose of P were applied as basal and remaining half dosed of N and K were applied as foliar spray at pre-flowering stage of crop. H₂B also exerted favourable effect on the grain yield of rice. Organophosphate (Profenofos) was found most effective followed by chlorpyrifos and insecticide (cypermethrin).

Improved fruit retention and yield by exogenous application of chemicals in mango (*Mangifera indica* L.) cv. Kesar

Anshul S. Lohakare*, V.N. Shinde, M. Jyothi and T.B. Tambe

Department of Horticulture, VNMKV, Parbhani

ABSTRACT

Aqueous solutions (0.1 and 0.01 mM) of PAs (Putrescine and spermine), Triacntanol 750 ppm, NAA 25 ppm, CPPU (Forchlorfenuron) 3 ppm, Salicylic acid (SA) 100 ppm, ZnSO₄ 0.5% and Boron 0.5 % were sprayed onto panicles of mango (*Mangifera indica* L. cv. Kesar) at different stages to investigate their effects on fruit retention and yield. The result revealed that significant minimum number of days taken from flowering to fruit set (25.70) was recorded in treatment T₈ (NAA 25 ppm + SA 100 ppm + B 0.5%). However, the maximum days from flowering to fruit set (35.05) was observed in treatment T₁₉ (control). The minimum days taken from fruit set to harvest (88.95) was recorded in treatment T₇ (NAA 25 ppm + SA 100 ppm + ZnSO₄ 0.5%) while the maximum days required from fruit set to harvest (99.45 days) was observed in treatment T₁₉ (control). The maximum number of fruit set per panicle at initial stage (62.18), number of fruits retained per panicle at pea stage (39.57), number of fruits retained per panicle at maturity stage (3.89) and maximum fruit yield per tree (69.21 kg) was also found in treatment T₇ (NAA 25 ppm + SA 100 ppm + ZnSO₄ 0.5%) whereas, lowest number of fruits retention per panicle at above different stages and minimum yield per tree was recorded in treatment T₁₉(control).

Keywords: Fruit retention, yield, chemicals, mango, Kesar

Effects of herbicides on weed dry matter and yield of wheat under zero-till condition

S. S. Yadav

PG College Ghazipur, U.P., India

ABSTRACT

An experiment was conducted in *rabi* season during 2003-04 and 2004-05 at research farm, C.S.A.U.A.&T., Kanpur to study the effect of various herbicides on weed control efficiency and yield of wheat under zero-till condition. Treatments include different doses of metribuzin, sulfosulfuron, isoproturon, isoguard plus, pendimethalin, hand weeding and unweeded control. Among weed control treatments, hand weeding twice i.e.30 and 45 DAS recorded significantly lower weed dry matter and was followed by metribuzin @ 175 g a.i./ha before first irrigation. Its further revealed that hand weeding twice recorded significantly higher weed control efficiency followed by metribuzin 175g a.i./ha before first irrigation and sulfosulfuron 25g a.i./ha after first irrigation. Nutrient depletion by weeds was minimum under hand weeding twice followed by metribuzin 175g a.i. /ha before first irrigation. Mean grain yield was significantly maximum (32.95 q/ha) with two hand weeding at 30 and 45 DAS. It was followed by metribuzin 175g a.i. /ha before first irrigation and sulfosulfuron 25g/ha after first irrigation with respective grain yields of 30.70 and 29.75 q/ha. Highest net return of Rs. 17105 /ha with 2.21 B:C ratio was obtained under

3rd International Conference on “Global Initiative in Agricultural, Forestry and Applied Sciences for Food Security, Environmental Safety and Sustainable Development (GIAFAS-2021)”

metribuzin 175g/ha followed by two hand weedings at 30 and 45 DAS with Rs. 17061/ha net return and 2.03 B:C ratio which was at par with each other. The treatment of unweeded control earned minimum of Rs. 6258/ha net return with 1.46 B:C ratio on mean basis over years. Significant economical differences were observed in all weed control treatments over unweeded control. Results showed that herbicide metribuzin @ 175g a.i. /ha before first irrigation or sulfosulfuron @ 25g /ha after first irrigation may be the better alternative of hand weeding in wheat grown under zero- till condition after rice.

Keywords: Weed, Wheat, Zero-till condition

Genetic variants of POU1F1 Gene and their association with litter size and growth traits in Assam Hill goats

Rakesh Kumar, Sourabh Deori, G. Khargharia, G. Kadirvel, Sunil Doley, Meena Das, Rajni Kumari*, K. K. Baruah and V.K.Mishra

Division of Animal and Fisheries Sciences, ICAR- Research Complex for North Eastern Hilly Region, Umiam-793103 (Meghalaya) – India

**ICAR- Research Complex for Eastern Region, Patna*

ABSTRACT

The POU (Pit-Oct-Unc) class 1 homeobox 1 (POU1F1, or Pit-1) directly regulates pituitary hormone-related genes, as well as affects the reproduction and growth in mammals. Thus, this study aimed to detect genetic polymorphisms of the POU1F1 gene and to determine their relationship with litter size and growth traits in Assam Hill goats. Comparative sequence analysis of the POU1F1 gene revealed three SNPs loci viz. g.682G>T, g.723T>G and g.837T>C in Assam Hill goats. The PCR-RFLP genotyping indicated that g.682G>T, g.723T>G and g.837T>C loci were monomorphic in the investigated population. As a result of all SNP loci having monomorphic banding patterns, no associations analyses could be carried out. In conclusion, a total of three novel SNPs loci of the POU1F1 gene were revealed by sequence analysis. The results of this study indicate the need for further investigation into the genes that influence litter size and growth traits in goats to establish potential markers for genomic selection in goat breeding.

Keywords: POU1F1 Gene; Polymorphisms; Litter size, Growth traits; Assam Hill goats

Sexual dimorphism in *Myrica esculenta* Buch.-Ham. ex D. Don

Vijay Laxmi Trivedi and Mohan Chandra Nautiyal

High Altitude Plant Physiology Research Centre (HAPPRC), HNB. Garhwal University (A Central University) Srinagar Garhwal (Uttarakhand) – 246174, India

ABSTRACT

Dioecy is the phenomenon which is rare in the flowering plants, where origin and evolutions of two sexual uniforms with different reproductive functions. To maintain the natural balance and existence of a dioecious species the proper functioning of the both the gender is must. Unlike the monoecious plants, reproductive cost is divided in two kinds of individuals in dioecious floras, hence both gender adapted differentially. Such segregation arise dimorphism in male and female plants of a dioecious plant species, the first kind of dimorphism in primary sexual organs such as in flowers which known as primary sexual dimorphism (PSD) and the other arises in other organs such as in leaves, shoots, and stems etc. that is known as Secondary sexual dimorphism (SSD). A highly valuable dioecious plant *Myrica esculenta* Buch.–Ham. ex D. Don (family Myricaceae), which is commonly known as “Kaphal” is a medium-sized, evergreen wild dioecious tree species. In this study we screened 3 populations of the *M. esculenta* for the secondary sexual dimorphism in floral and vegetative characteristics and found the considerable variations in gender level.

Keywords: SOD; POD; Leaves; Flowers; Male plants, Female plants

Innovations in Extension for Doubling Farmers Income

Peddi Naga Harsha Vardhan and Deepa Roy

Department of Agriculture Extension, Uttar Banga Krishi Viswavidyalaya, Cooch Behar-736165.

ABSTRACT

India has always focused on raising agricultural output and improving food security. Farmers' income didn't get recognition. Hence, remained low compared to income of those working in nonfarm sector. Because of low income farmer suicides and youth leaving farming which may lead to food insecurity in future. In order to promote farmers' welfare, Reduce agrarian distress, bringing parity between income of farmers and others it is important to raise farmers income. In 2016 Indian government had set a highly ambitious target of doubling farmers' income by 2022. Present enlightened farmers of India were more interested in getting right knowledge rather than to have subsidy. In this context, agricultural extension would certainly need transformation. Conscious deployment of rural youth and progressive farmers will help in transfer of technology. Moreover, farmers' welfare needs to be ensured through 'Farmer First' approach to benefit equally both producers and consumers. Further, in view of diverse demand of new innovations, new products, new information and new extension services, there is a need to shift from “top-down” to “bottom-up” approach, involving farmers' participation at the grass-root level, while ensuring confidence building among farming communities to take risk and adopt more scientific and resilient agriculture. Knowledge sharing on good agricultural practices without dissemination loss, and incentives for timely supply of inputs become highly critical to double farmers' income. The committee on doubling farmers' income recommended seven sources of income growth. These include improvement in crop productivity; improvement in livestock productivity; resource use efficiency or savings in the cost of production; and increase in the cropping intensity.

Keywords: Doubling farmers' income, farmer first approach, bottom up approach

Impact of integrated nutrient management on growth attributes of okra [*Abelmoschus esculentus* (L.) Moench] Cv. Arka Anamika

B. Maruthi^{1*}, Dr. M. Hanuman Nayak², Dr. A. Kiran Kumar² and Dr. D. Vijaya³

¹Department of Vegetable Science, Bidhan Chandra Krishi Viswavidyalaya, Mohanpur- 741252, West Bengal, India

²Department of Horticulture, Vegetable Research Station, SKLTSU, Hyderabad, Telangana-500030, India

³Department of Soil Science and Analytical Chemistry, Grape Research Station, SKLTSU, Hyderabad, Telangana-500030, India

ABSTRACT

The present investigation was carried out at College of Horticulture, Rajendranagar, Sri Konda Laxman Telangana State Horticultural University during the Kharif season from July to November 2019 to reveal the impact of integrated nutrient management on the growth attributes of okra. The data showed that growth attributes were significantly affected due to the different treatments. Among different treatments, the treatment T₇ consisted of inorganic fertilizers in combination with organic manures and biofertilizers i.e. 75% RDF + 12.5% RDN through FYM + 12.5% RDN through vermicompost + *Azotobacter* + Phosphorus solubilizing bacteria [PSB] recorded significantly higher plant height (25.5, 78.6 and 126.1 cm), number of leaves (12, 46 and 55.7), number of branches (0, 2.7 and 5.01) and internodal length (2.8, 6.07 and 7.55 cm) at 30, 60 and at final harvest respectively. And also recorded the highest Fresh weight of the plant (15.58 t/ha) and Dry matter yield of the plant (1989 kg/ha).

Exploration of Different Strategies in Integrated Sheath Blight Disease Management for Rice Mat Nursery

Yeluru Mohan Babu¹, Susmita Jha², Sekhar Bandyopadhyay², P. M. Bhattacharya² and Apurba kumar chowdhury²

¹Division of Plant Pathology, Indian Agricultural Research Institute, New Delhi-110 012, India

²Department of Plant Pathology, Uttar Banga Krishi Viswavidyalaya, Pundibari, Coochbehar, West Bengal - 736165, India

ABSTRACT

Rice is a very Crop of India as well as west Bengal. The crop is affected by number of diseases. Out of those Sheath blight disease caused by *Rhizoctonia solani* is responsible for yield loss upto 45%. Now – a – days rice transplanting is done mechanically by machines. For machine transplanting rice mat nursery has to be prepared. In rice mat

3rd International Conference on “Global Initiative in Agricultural, Forestry and Applied Sciences for Food Security, Environmental Safety and Sustainable Development (GIAFAS-2021)”

nursery farmers are facing the problem of sheath blight disease in a huge extent as the humidity is increased here because the trays where seedlings are prepared has to be covered by polythene for 14 days. So, to reduce this problem this topic is chosen with the following objectives:

1. To standardize a quick protocol for estimation of sheath blight in mat nursery for machine transplanted rice
2. To find few biotic and abiotic agents that may manage sheath blight in mat nursery
3. To formulate an integrated disease management protocol sheath blight management in mat nursery

The pathogen *Rhizoctonia solani* is the causal agent we proved Koch's postulates and under humid conditions this pathogen found to be escaping from soil to canopy. And we found canopy based automated disease quantification methodology found to be accurate and effective and it was found that 100 gram seed density found to be less effected by *Rhizoctonia solani* lowest disease severity 29.72% corresponding to 534.95 cm² of affected area of 1800cm², in search for best agent to control this pathogen we discerned variety of biotic and abiotic agents and their combinations to find best one in inoculated treatments highest FGCC and 69.81% and lowest canopy temperature (26.63%) found in CuCl₂ treatment (T5) biochemical defence enzyme expression shown peroxidase (54%) and polyphenol oxidase (52%) and super oxide dismutase has (67%) negative correlation with disease incidence and they (defence enzymes) also had very high positive correlation with each other, in root system reconstruction analysis studies revealed most of the root system characteristics found to be best in *Trichoderma viridae* treated seedlings 56% negative correlation found between second order root length and disease severity, in histopathological study some amount of infection cushions found on most of the treatments however in *pseudomonas fluorescens* and riboflavin treated seedling no infection development observed, 87% correlation found between disease scoring by FGCC and IMAGEJ methodology so CANOPEO based methodology was adopted for disease scoring and treatment screening as this is quick and accurate and it was found PF+TRICHO+PSB combination is the best as it produced lowest (7.4%) disease severity this treatment is followed by SSP+MOP+CUCL₂ +PF+TRICHO+PSB (9.86%).

Contribution of edible insects for the food and feed security

Tumma Mounika*, Tapan Kumar Hath

Uttar Banga Krishi Vishwavidyalay, Pundibari, West Bengal- 736165.

ABSTRACT

Due to the urbanization, rising of the middle classes and population growth lead to the increase in the global demand for food, especially protein source based on animals. There is a need to find alternate protein source. Insects contribute to food and feed security. Entomophagy is nothing but consumption of the insects by the human beings. It is practiced in many countries, predominantly in some parts of Asia, Africa etc. Around 2000 insect's species were consumed world wide as a whole insects or incorporated as an ingredient in the food products. Due to the high micro and macro nutrient levels in insects, Including of the edible insects in the human diet has shown the increase of the nutritional quality compared to some times higher than animal derived foods. Most insect species occurs seasonally and some are available throughout the year. Almost all the group of insects are eaten i.e., beetles (31%), caterpillars (18%) ants and bees (15%), Locust, grasshoppers, crickets (13%), termites, dragon flies and others (12%) and true bugs (11%). The essential amino acid levels in the insect species were comparable with soybean protein. Among many ways of developing food and feed security the insect farming is the one of them. Insects are found everywhere and they can reproduce in a short period. They have high growth rate and feed conservation rate. In next decade, an insect as a feed to the poultry aqua culture becomes more prevalent. Using of palatable insects meal for poultry, pigs, fishes could replace 25-100% of soy meal or scare fish meal as feed ingredient. Insects farming and harvesting provides an entrepreneurship opportunities in the developed and developing countries. By generation and sharing of the knowledge through expert meeting, web portal, publication, by raising the role of insects through media collaboration, Networking and interactions with stakeholders working with nutrition, feed and legislation related sectors can help the acceptance of insects in the food and feed.

Keywords: Edible insects, Entomophagy, Food, Feed, Farming, Nutrition

Standardization of Integrated Nutrient Management for Growth and Yield of Tomato

Eggadi Ramesh* and Subhamoy Sikder

Department of Vegetable and Spice Crops, Faculty of Horticulture, Uttar Banga Krishi Viswavidyalaya, Pundibari, Cooch Behar, West Bengal, India.

ABSTRACT

The present study on “Standardization of integrated nutrient management for growth and yield of tomato” was carried out at the Instructional Farm, Faculty of Horticulture of Uttar Banga Krishi Vishwavidyalaya, and Pundibari, Cooch Behar during *rabi* season of 2019-2020. The experiment was laid out in a randomized block design (RBD) with 14 treatments with three replications maintained. The treatments consisted of different combinations of organic manures and inorganic fertilizers *i.e.*, A₁ (recommended NPK), A₂ (100% FYM), A₃ (100% VC), A₄ (100% PM), A₅ (100% NC), A₆ (100% VC + 100% FYM + 100% PM + 100% NC), A₇ (½ recommended NPK + 50 % FYM + 50 % VC), A₈ (½ recommended NPK + 50 % FYM + 30 % VC + 20% PM), A₉ (½ recommended NPK + 50 % FYM + 50 % VC + NC), A₁₀ (½ recommended NPK + 50 % FYM + 30 % VC + 20% PM + NC), A₁₁ (½ recommended NPK + 50 % FYM + 50 % VC + PSB), A₁₂ (½ recommended NPK + 50 % FYM + 30 % VC + 20% PM + PSB), A₁₃ (½ recommended NPK + 50 % FYM + 50 % VC + NC + PSB) and A₁₄ (½ recommended NPK + 50 % FYM + 30 % VC + 20% PM + NC + PSB). All the growth and yield parameters were recorded maximum stem girth at last harvest (14.85mm), days to first flowering (27.46), number of truss per plant (20.59), individual fruit weight (127.71g), fruit yield per plant (4.49 kg) and yield per hectare (99.52t/ha) with treatment A₈ (½ recommended NPK + 50 % FYM + 30 % VC + 20% PM).

Keywords: Tomato, Organic manure, Recommended NPK, Growth and Yield

Progress and prospects of genome sequencing of Garden pea (*Pisum sativum*)

P. Shiva Kishore^{1*}, Saikat Gantait¹, Sujaya Dewanjee¹ and Suvendu Kumar Roy²

¹*Department of Genetics and Plant Breeding, Bidhan Chandra Krishi Viswavidyalaya, Mohanpur- 741252, West Bengal, India*

²*Department of Genetics and Plant Breeding Uttar Banga Krishi Viswavidyalaya, Pundibari, Cooch Behar, (West Bengal), India.*

ABSTRACT

The pea (*Pisum sativum* L.) is one of the world's most ancient domesticated crops. The pea is the world's second most frequently farmed pulse crop, after the common bean. Genome sequencing is a method of extracting and interpreting genetic information from DNA or RNA. In comparison to other legumes, the pea has a much larger and more complex genome. The legA gene was the first to be sequenced in garden pea. *Pisum sativum* unigene v1 (2010), *Pisum sativum* unigene wa1 (2010), *Pisum sativum* unigene v2 (2011), *Pisum sativum* CSFL RefTrans V1 (2016), *P. sativum* CSFL RefTrans V2 (2017), *Pisum sativum* Cameor genome v1a (2019). In 2019, the reference genome of the 1973-released French cultivar "Caméor" was sequenced using Whole Genome Shotgun and paired-end sequencing techniques (PacBio RSII and Illumina). For assembly, the SoapdeNovo2 approach is used. The genome is 3,920,161,095 bp long and contains 24,623 scaffolds, with 10,237 of them anchored to the seven pseudomolecules. There are a total of 44,756 genes. 294 X genome sequencing reads were generated to acquire this sequence. For comparative research, proteomics, and metabolomics of *Pisum sativum* species, the genomic sequence of *Pisum sativum* can be employed. The garden pea genome sequence can be used to study the evolution of genome structure and characterise genes. This high-quality, annotated pea genome sequence will help characterization of many known mutations, enhance pea improvement, and make more efficient use of the genus' genetic diversity.

Keywords: genome sequencing, whole-genome sequencing, proteomics, metabolomics

Precision farming: Shifting from the conventional farming system

Daripalli Srilakshmi and Subhendu Shekhar Gantait

Bidhan Chandra Krishi Viswavidyalaya, Mohanpur, West Bengal

ABSTRACT

Agriculture, being an interaction of several inputs such as seed, soil, water and agrochemicals, has come to a point where all the inputs used in such complex system are to be used prudently in order to maintain sustainability. Due to total disregard of proper management of such inputs, without considering the effect it has on ecology, has led to degradation of environment. Maximizing the input use efficiency has turned out to be a good alternative without

giving an adverse effect. Exploiting of all the advanced tools that utilize the information technology and agricultural sciences is proving to be beneficial in economic and environmentally sustainable crop production. Precision farming has been defined as information and technology based farm management system to identify, analyze and manage spatial and temporal variability within fields for optimum productivity and profitability, sustainability and protection of the land resource by minimizing the production costs. Site specific management is a management that has compelled the growers to modify agricultural management practices by using the right quantity of inputs at the right time and in the right place. The various tools used in SSM such as GIS, remote sensing and GPS have been shown to help in developing a comprehensive management plan that consequently improved the production efficiency with increased yield and with very little adverse effect on the environment. Various advanced equipments such as robots and drones will soon become a part of the site specific management in the near future and drastically change the way of farming.

Cold plasma technique expanding its wings with the combination of other technologies in food preservation

Srujana Eda*, Prodyut Kumar Paul

Department of Post Harvest Technology, Uttar Banga Krishi Viswavidyalaya, West Bengal

ABSTRACT

The basis of the food processing techniques for preservation is the inhibition of microbial growth. The growth of microorganisms is the reason behind food spoilage and therefore inhibiting their growth can facilitate increase in shelf life of foods. Some of the first and the most earliest forms of food preservation that were used embody cooling (reduced temperature storage) and cooking (thermal processing). The limitation of each of these techniques is that if foods are cooled or heated for a prolonged amount of time, most products may become unpalatable or less desirable as organoleptic qualities are destroyed but non-thermal processing techniques aims to inactivate microorganisms within food products while preserving its nutritional and sensory qualities. Non-thermal techniques preserve the natural aroma and flavour, and increase microbiological food safety while not inflicting loss of quality, which is determined in heat treatment. Plasma technology is non-thermal technique pertained to foods in recent years. The principle behind plasma technology is based on the partial ionization of negative and positive ions, free radicals, charged particles in the form of electrons and photons, and gas-containing molecules. Plasma can interact with bacterial cells and inactivate microorganisms, as well as spores and viruses. Cold plasma, which is created under vacuum and at room temperature, is an economical, and reliable method which aids in microbial inactivation, sterilization, enzymes control preservation. The cold plasma (CP) technique is employed for food processing for enhancing antimicrobial activity, structural modification, decontamination of surfaces, and disinfection of food-processing instruments. Currently, a combination of CP with alternative promising approaches, such as nanotechnology applications, including nanofibers, nanoemulsions, nanoparticles, and nanoencapsulation, and emerging nonthermal technologies, including pulsed electric field (PEF), pulsed light (PL), ozone technology and ultrasound, is gaining increased recognition.

Keywords: Cold plasma technology, food preservation, microbial inactivation.

Conventional control measures against Rugose spiraling whitefly, *Aleurodicus rugioperculatus* Martin (Hemiptera: Aleyrodidae) in Godavari districts, Andhra Pradesh

S. Sushmitha*, A. Sujatha

College of Horticulture, Dr. Y. S. R. Horticultural University, Venkataramannagudem - 534101, Andhra Pradesh, India

ABSTRACT

The rugose spiraling whitefly (RSW), *Aleurodicus rugioperculatus* is an introduced pest first described from Central America and was first documented as a pest on gumbo limbo (*Bursera simaruba* L). In India RSW was found highly polyphagous, attacking wide range of plant species including plantation, spice and medicinal plants, fruits, vegetables, flowers, ornamental crops and many other weeds. Concerns about the potentially negative impacts of broad-spectrum insecticides on environmental quality, food security and natural enemies have lead to research aimed at minimizing the use of insecticides for pest management. In fact, it has now become imperative to develop a holistic system of tackling pests to make it more environmental friendly. An experiment was conducted to determine

3rd International Conference on “Global Initiative in Agricultural, Forestry and Applied Sciences for Food Security, Environmental Safety and Sustainable Development (GIAFAS-2021)”

the attractive action of different colours of sticky traps to RSW. Among the various coloured sticky traps tested, RSW adults were more attractive to yellow colour trap irrespective of the height or crop in which it was placed followed by green coloured sticky trap.

Keywords: Invasive, *Aleurodicus rugioperculatus*, Gumbo limbo

Effect of herbal edible coating to extend the shelf life of banana var. Ney poovan stored at room temperature

Venkatesan.S* and M. Chitra

**Department of Horticulture, Faculty of Agriculture, Annamalai University, Annamalai nagar-608 002, Cuddalore District, Tamil Nadu, India*

ABSTRACT

Banana is one of the oldest fruits known to mankind and also an important food for man. Bananas are highly perishable in nature and are generally treated with the fungicides like Prochloraz and Imazalil to control post-harvest pathogens. Most of the synthetic preservatives produce several side-effects as carcinogenicity, teratogenicity and residual toxicity. The herbal edible coatings are safe to human as well as environment. Considering the above facts the present investigation was carried out in the Department of Horticulture, Faculty of Agriculture, Annamalai University, Tamil Nadu. The experiment was conducted in a Completely Randomized Design with 13 treatments which were replicated thrice. In this experiment the harvested banana bunch was exposed to smoke for regulating the uniform ripening of fruits in the bunch. The treatments consisted of corn starch alone at 2,4 and 6 per cent and combination with the herbal extract viz., Tulsi extract, mint extract and papaya leaf extract @ 2, 4 and 6 per cent and control was maintained. The results of the study revealed that the banana fruits dipped in corn starch at 6 per cent with papaya leaf extract 6 per cent significantly increased the shelf life, reduced the physiological loss in weight and fruit spoilage percentage. With regard to the biochemical parameters Ney Poovan banana fruits during storage, the total soluble solids, total sugars, reducing sugars, non-reducing sugars, titrable acidity and ascorbic acid content were found to be the maximum in the treatment (T13) in which fruits were dipped in corn starch at 6 per cent with papaya leaf extract 6 per cent when compared to the control and other herbal edible coating treatments.

Keywords: Banana, Herbal edible coating, Shelf life, Tulsi extract, Mint extract and Papaya leaf extract

***Punica granatum* peel as a sustainable source for the prevention hypertension**

Uroosa Noor and Ena Gupta

ABSTRACT

Punica granatum is commonly known as pomegranate is widely cultivated in India that generates million tons of fruit waste mainly peel and seed every year. Pomegranate peel is a rich source of phytochemicals which contains high quantities of antioxidant and polyphenolic compounds as compared to other part of the fruit. Major bioactive compounds present in the peels are ellagic acid, gallic acid, punicalagin, tannins and flavonoids which mainly provides pharmacological properties i.e. antihypertensive, anti-aging, anti-cancer, anti-inflammatory etc. Hypertension is associated with many diseases such as cardiovascular disease, type 2- diabetes, anti-inflammatory, end stage renal disease, cerebrovascular disease and metabolic syndrome. Finding from several studies showed that presence of some antioxidant in the peels of pomegranate prove to reduce the risk of hypertension by inhibiting the activity of serum angiotensin converting enzyme which eventually decreased the systolic blood pressure. Pomegranate fruit as whole is also known as heart healthy fruit, due to its anti-hypertensive activity which ultimately improves the heart health. Overall this review explores the antihypertensive activity of *P. granatum* peel.

Keywords: *Punicagranatum*, fruit waste, antioxidant, hypertension, polyphenolic compounds.

Role of minor forest produces in sustainable development

Damini Sharma

ABSTRACT

The fringe villagers of forest areas have their dependency on minor forest produces whether it is nationally specified such as Tendu leaf, Gum or non-specified such as Harra, Sal seed, both the produces are major basis for economical support to the communities existing in the tribal areas. Thus, the study assessed potential production quantities and

3rd International Conference on “Global Initiative in Agricultural, Forestry and Applied Sciences for Food Security, Environmental Safety and Sustainable Development (GIAFAS-2021)”

SWOT analysis of minor forest produces of the state Chhattisgarh which has the third largest forest cover of India. The people of the state have major concern on tendu leaf compare to the other forest produces. The outcome of the work concluded the strength, weakness, opportunity and threat of minor forest produces sector of the area. As the tribal state and covering large forest area, the minor forest produces have greater potential to contribute in achievement of sustainable development goals.

Keywords: Minor forest Produces; Minimum support price; Tribal; Marketing Channel; Tendu leaf

Effect of temperature and pH level on the growth of bacterial wilt causing *Ralstonia solanacearum* bacteria under *in vitro* conditions

R. R. Bhanwar

S.G. College of Agriculture and Research Station (IGKV), Jagdalpur-494005, Bastar, Chhattisgarh, India

ABSTRACT

Bacterial wilt is one of the major diseases of all solanaceous plants. The disease is known to occur in the wet tropical, subtropical and some temperate regions of the world. The disease is caused by the bacterium *Ralstonia solanacearum* (Smith) Yabuuchi *et al*, previously known as *Pseudomonas solanacearum*. In Chhattisgarh state, Bacterial wilt of solanaceous crop caused by *Ralstonia solanacearum* has been grouped under Race 1 and Biovar 3 in the previous study, which attacks wide range of crop plants, ornamentals and weeds in extremely dangerous conditions at 25-28°C temperature and 5.5-6.6 pH in field conditions. Whereas, other groups of races of *Ralstonia solanacearum* have more severe in temperatures range of 35-37°C. Soil temperature and pH is a major factor affecting the wilt causing bacterial and fungal pathogens and soil microbial community. In the present study, four temperature ranges i.e. 20°C, 25°C, 30°C and 35°C and 10 pH levels i.e. 4, 4.5, 5.0, 5.5, 6.0, 6.5, 7.0, 7.5, 8.0 and 8.5 on *Ralstonia solanacearum* were tested under *in vitro* condition and found that the population of *Ralstonia solanacearum* (443.33 cfu) were significantly higher on 6.50 pH level at 30°C after 96 hours of inoculation on TZC medium and the population of *Ralstonia solanacearum* was not able to grow in 4 pH at 20°C, 25°C, 35°C and 40°C.

Keywords: *Ralstonia solanacearum*, temperature, pH, bacterial wilt of solanaceous crop

Pattern of Livelihood Diversification of Households in India

Diksha, Sudhakar Dwivedi, Jyoti Kachroo, Akshaydeep

Division of Agricultural Economics and ABM, SKUAST Jammu

ABSTRACT

Increase in mechanization in agriculture has decreased the demand of manual labour thus; various non-farm activities serve the purpose of providing the prospects of employment and income to the household and rural work force. The contribution of agriculture to GDP is continuously decreasing which shows the shift of society from farm to non-farm activities. For assessing the economic well-being of individuals and of society as a whole and to assess the effect of both universal and targeted actions (such as welfare, taxation and other fiscal policies) on the socio-economic groups monitoring changes in sources of income and income distribution for population is important. An attempt has been made to study the pattern of livelihood diversification of household in India with a special case of rural population using the secondary data. Trend showed that over a longer period, from 1991 to 2019, employment in agriculture as a percentage of total employed dropped from 63 percent to 43 percent and per capita income is inversely proportional to poverty. Major source of income are agriculture and wages and salaries where farmers with less than 2 hectares of land are found to be wage labourers and those with more than 2 hectares of land are found to be engaged in agriculture thus a decreasing trend in diversification with increase in size of land holding. Number of income sources had positive effect on the income of households. More diverse the source of income, better the income opportunities. Pluriactivity is observed in agricultural households. The shift from agriculture has been mainly to construction, manufacturing and trade and hotels sector. States like Jammu & Kashmir, Himachal Pradesh, Sikkim, Meghalaya, Andhra Pradesh witnessed an increase in non-farm employment with high income and high diversification. The higher educated groups found to move away from agriculture into more of casual labour and less into remittances. So, policies and interventions for creating employment opportunities have to be designed for promoting NFL in a big way along with strengthening the existing institutions.

Keywords: Livelihood diversification, rural economy, pluriactivity, employment

Allelopathic effect of *Cymbopogon nardus* on *Eupatorium adenophorum*
Sonam Rawat*, Monali Chauhan, Pallavi sati, Sudeep Chandra, M.C. Nautiyal
High Altitude Plant Physiology Research Center, HNB Garhwal University Srinagar

ABSTRACT

Biological invasion of weeds is a big threat to agriculture and ecosystem, challenging global food security. Chemical and mechanical approaches to weed management have adverse effects on the ecosystem, viz damage to native flora, soil erosion. Biological management of weeds through allelopathic activity can be a valuable choice to minimize the weed invasion. Hence the present study aims to manage an invasive weed *Eupatorium adenophorum* Spreng using environmentally friendly approaches. *Cymbopogon nardus* L. was selected for intercropping with *E. adenophorum*, two kinds of approaches were followed: - 1st was to find out the effect of different concentrations of powdered crude material of *E. adenophorum* on the growth and biochemistry of *C. nardus*, the 2nd approach was planting both *E. adenophorum* and *C. nardus* together to find out the allelopathic interaction in the field conditions. The soil rich with higher concentration of *E. adenophorum* crude powder influence the growth and biochemistry of *C. nardus*, concentration till 5% found suitable for plant growth and also showed higher value of Total Phenolic Content (TPC), Total Soluble Sugars (TSS). In field study all the the Leaf area, number of leaves, TPC and TSS of *C. nardus* showed negative correlation with morphological and biochemical parameters of *E. adenophorum*. The survival of *C. nardus* in the *E. adenophorum* farruginous soil, and inhibition of *E. adenophorum* intercropped with *C. nardus* are key finding of our study. The present study suggested that plantation of *C. nardus* can be a valuable choice (due to commercial value in pharmaceutical and essential oil industries) at the places which are already invaded by *E. adenophorum*.

Keywords: Allelopathy, Weed management, Sustainability

Correlation coefficient and Path analysis for seed yield and its attributing traits in Niger [*Guizotia abyssinica* (L. f.) Cass.]

J.L. Salam and Kusumlata baghel

S. G. College of Agriculture and Research Station, Jagdalpur 494005 Chhattisgarh, India

ABSTRACT

The present study “Correlation coefficient and Path analysis for seed yield and its attributing traits in Niger [*Guizotia abyssinica* (L. f.) Cass.]” was carried with 53 niger accession including 3 check varieties. At the instructional cum research farm of S.G. College of agriculture and research station, Jagdalpur (C.G.) during *kharif* 2017. Present investigation indicated that genotypic correlation was higher in magnitude than their respective phenotypic correlation for all traits. Seed yield per plant (g) had highly significant positive correlation with harvest index (%) followed by capitulum per plant, seeds per capitulum, primary branching per plant, straw yield per plant (g), test weight (g), oil content (%), plant height (cm) at genotypic and phenotypic levels. The data revealed that the highest positive direct effect on seed yield per plant (g) was harvest index (%) followed by straw yield per plant (g), capitulum per plant, days to 50% flowering and oil content (%) these characters are very important because they are directly proportional to seed yield per plant (g) and that could be used in selection for high yielding genotypes of Niger crop.

Keyword: Path analysis, correlation coefficient analysis, *Guizotia abyssinica*

Changes in Structural Characteristics of Humic acid in soils having different nutrient management practices as revealed by spectroscopic techniques

Priya Saini¹, Abir Dey² and Mahesh C. Meena²

¹*Division of Agricultural Chemical, ICAR-Indian Agricultural Research Institute, New Delhi 110012*

²*Division of Soil Science and Agricultural Chemistry, ICAR-Indian Agricultural Research Institute, New Delhi 110012*

ABSTRACT

The intensive cropping in northwestern Indo-Gangetic Plains (NW-IGP) for past four decades has been widely reported the decline in the quality of soil organic matter. It has been emerged from the reports from different on-going trials under the aegis of All India Coordinated Research Project on Long Term Fertilizer Experiments

(AICRP-LTFE), that integrated nutrient management (INM) can be one option to stabilize crop productivity and have a sustainable system. For the study, the surface (0-15 cm) soil samples were collected from selected treatments of the on-going AICRP-LTFE, ICAR-IARI, New Delhi under maize-wheat system after wheat harvest. The selected treatments viz., Unfertilized control, N (Recommended doses of N only), NPK (Recommended doses of N, P and K), 150% NPK (150% of recommended doses of N, P and K) and NPK+FYM (recommended NPK along with 5 t farmyard manure/ha) were studied to assess the changes in structural characteristics of humic acids as affected by long-term integrated nutrient management. The humic acids (HAs) were extracted by alkali (sodium hydroxide - sodium pyrophosphate) mixture in N₂ environment. The amount of HA extracted from soil was significantly high for NPK+FYM plot. The HA extracted from NPK+FYM had the highest E₄/E₆ ratio indicating least aromaticity as compared to very low E₄/E₆ ratio under control, N and NPK. The Fourier transformed infrared spectroscopy (FT-IR) of different HAs extracted from treatments showed all the representative bands of the functional groups commonly present in HA. The various spectroscopic studies predict that organic carbon from control was highly aromatic while from plots having farm yard manure and chemical fertilizer treatment organic carbon was least aromatic. Solid state ¹³C NMR spectrum of the extracted HA also suggested the similar trend. The lower aromaticity and acidity of HA extracted from INM plots indicated a higher inflow of organic matter in those plots, often in excess of the assimilation capacity of soil microbes. Therefore, continuous application of FYM along with recommended NPK improved the C quality as indicated by lower aromaticity due to lesser rates of humification, which are beneficial in terms of soil health and sustainability of the cropping system.

Tolerance of *Eisenia fetida* towards herbicide (metsulfuron-methyl)

Anu Bala Chowdhary^{1*}, Jahangeer Quadar¹, Sharanpreet Singh¹, Jaswinder Singh², Adarsh Pal Vig¹

¹Department of Botanical and Environmental Sciences, Guru Nanak Dev University, Amritsar, Punjab 143005, India

²Post Graduate Department of Zoology, Khalsa College, Amritsar, Punjab 143005, India

ABSTRACT

The increasing applications of pesticides in the agricultural sector have adversely influenced the flora and fauna of the soil. The variety and quantity of pesticides used per hectare are rising globally, with an increase in the area of soil surfaces. More than 400 types of herbicides are widely used to control the harm of weed for increasing the output and quality of agricultural products. One of the most used herbicides belonging to the sulfonylurea chemical group is metsulfuron-methyl, used to control a large variety of annual grasses and broad-leaved weeds in pre and post-emergence application. Pesticide ecotoxicology is a new branch of toxicology that studies the effects of pesticides on non-target organisms in the soil ecosystem. Earthworm is an important soil biota as well as an important species in ecotoxicological risk evaluation of soil pollution induced by pesticides or other toxins. Earthworm is a ubiquitous animal species that accounts for the majority of soil faunal biomass. The decrease in earthworm abundance in the soil may have an impact on nutrient cycling and their availability for plants. They have been considered as bio-indicators of contamination in the soil and also known to sustain the soils' ecological functions. However, the continuous application of herbicides had caused serious environmental pollution and poses threat to the ecosystem. In the light of above facts, the present study evaluated the tolerance capacity of *Eisenia fetida* towards herbicide (metsulfuron-methyl) by assessing different parameters like growth and reproduction. In the present study, low concentrations showed less effect on earthworm growth and reproduction and provide valuable information regarding the tolerance of earthworms to metsulfuron-methyl.

Keywords: Earthworm, Ecotoxicology, Herbicides, Metsulfuron-methyl, Pesticides

Effect of germination on nutritional and anti-nutritional components of Adzuki bean

Qurat Ul Eain Hyder Rizvi*, Krishan Kumar, Priyanka Thakur, Divya Chauhan, Naseer Ahmed

Department of Food Technology, Dr. Khem Singh Gill Akal College of Agriculture, Eternal University, Baru Sahib, Sirmour, HP- 173101

ABSTRACT

Adzuki bean (*Vigna angularis* L.) is the important legume with high protein and amino acid content that makes them a suitable cheap source for fortification of various cereal diets. Adzuki bean is a good source of essential fatty acids, fiber, minerals and phytochemicals such as polyphenols and phytates. The raw grains are rich in vital nutrients but contain some anti-nutritional components. Germination reduced the anti-nutritional factors and increased the

bioavailability of macro and micronutrients as well as the level of phytochemicals. In the present study, the adzuki beans were germinated for 72 h and were evaluated for nutritional and anti-nutritional properties at 24, 48, and 72 h intervals. Germination significantly increased the antioxidant potential of the sprouted adzuki beans. The protein content of adzuki bean increased from 19.56 (raw grains) to 23.45% after germination for 72 h. The phenolic content increased from 22.78 mg/g (raw grains) to 25.58 mg/g after germination for 72 h. Similarly, the antioxidant content in adzuki bean increased from 9.74 to 16.67% during germination for 72 h. There was decreases in fat content and values decreased from 3.16 (raw grains) to 1.95% after germination for 72 h. There was reduction in anti-nutritional components of adzuki beans during germination. The phytic acid content of adzuki bean decreased from 6.52 (raw grain) to 3.45 mg/g. Similarly, the tannin content decreased from 6.09 to 3.56 mg/g. Results attained during the study concluded that there was increase in the bioactive components and reduction of anti-nutritional components of the adzuki bean during soaking and germination treatments.

Keywords: adzuki Bean, Nutritional Components, Germination, Bioactive Components

Response of different temperature and media on growth and sporulation of entomopathogenic fungi

Vinod K. Nirmalkar^{*1}, N. Lakpale² and R.K.S. Tiwari¹

¹State bio-control Laboratory, BTC College of Agriculture & Research Station, Sarkanda, Bilaspur, 495001 (I.G.K.V.) (C.G.)

²Department of Plant Pathology, College of Agriculture, Raipur (I.G.K.V.) (C.G.)

ABSTRACT

Now the days chemical inputs in agriculture, increasing resistance to insecticides has provided great impetus to the development of alternative forms of insect-pest management. Microbial control of crop pests offers environmentally acceptable strategies with lower cost and longer run effect. The bioagents i.e. *Bacillus subtilis*, *Pseudomonas fluorescens*, *Trichoderma viride* /*harzianum* controlling plant disease and entomopathogenic fungus and that act as a parasite of insects and kills or seriously disables them, comprise a diverse group of over 90 genera with approximately 750 species, reported from different insects and these are potentially the most versatile biological control agents due to their wide host range. Entomopathogenic fungi and bio-control agents are naturally occurring organisms which are perceived as less damaging to the environment. Their occurrence and distribution are widely distributed in diverse habitats. It is important to know the ideal temperatures and their specific media for higher mycelial growth, fresh & dry wet of mycelia and sporulation for mass production in easily and cheaper cost. Sporulations play a very important role for management of insects and faster growth of mycelia play role for faster sporulation. On the above a research was framed to identify appropriate temperature and media for better mass production and confined that mycelial growth, fresh weight and sporulation of *B. bassiana* and *M. anisopliae* isolates most favourable temperature for all the isolates of *B. bassiana* were found at 25°C (62.85 mm, 11.98 g, 14.56x10⁷) and 30°C (65.16 mm, 8.66g, 13.02x10⁷). Fresh wet, dry wet and sporulation of *M. anisopliae* recorded maximum at 25°C (15.404g, 2.310g and 52.81x10⁷) followed by 30°C (14.422, 2.205g and 47.26 x10⁷). Seven different media were also evaluated for mycelial growth and sporulation of *B. bassiana* and *M. anisopliae* under *in vitro* condition. *B. bassiana* showed maximum mean mycelial growth by SDA media (71.35 mm) and least growth by YMA (49.44 mm). Maximum mean sporulation in PDA (24.81x10⁷) and least sporulating media was CDA (4.06x10⁷). In case of *M. anisopliae* isolates showed maximum mean mycelial growth by PDA media (81.83 mm) followed by SDA (72.83 mm) while, sporulation was maximum in PDA (45.84x10⁷) and least in YMA (18.52x10⁷) media.

Keywords: *Beauveria bassiana*, *Metarhizium anisopliae*, mycelial growth, temperature, entomopathogenic fungi

Impact of Citrus based agroforestry systems on above ground, below ground biomass and carbon sequestration

Aarti P Deshmukh, Lalji Singh, V. M. Ilorkar and P. D. Raut

Department of Forestry, Indira Gandhi Krishi vishwavidyalya Raipur -492 012, Chhattisgarh, India.

AICRP on Agroforestry college of agriculture, Near Maharajbagh Nagpur 440012, (M.S.) India.

ABSTRACT

Carbon sequestration by green plant is suitable way to reduce atmospheric CO₂ in the present investigation above ground biomass and below ground biomass carbon sequestration potential of different forest species

3rd International Conference on “Global Initiative in Agricultural, Forestry and Applied Sciences for Food Security, Environmental Safety and Sustainable Development (GIAFAS-2021)”

(*Tectonagrandis Eucalyptus teritocornis*, *Ailanthus excelsa*) under citrus based agroforestry system was measured. Total standing above ground biomass and below ground biomass of *Eucalyptus teretocornis* 49.99 and 12.99, *Ailanthus excelsa* 20.34 and 5.28 t ha⁻¹, and *Tectona grandis* are 10.63 and 2.76, respectively, while total standing biomass in above forest species are 13.39, 62.98 and 2.87 t ha⁻¹. The sequestered carbon stock in above ground biomass and below ground standing biomass *Eucalyptus teretocornis* 24.99 and 6.49, *Ailanthus excelsa* 10.17 and 2.64 and *Tectona grandis* are 5.31 and 1.38 t ha⁻¹, respectively while total carbon sequestered in above forest species are 6.69, 31.49 and 12.81 t ha⁻¹.

Keywords: *Tectonagrandis Eucalyptus teritocornis*, *Ailanthus excelsa*

Current status of Maydis Leaf Blight of Maize in India – A Review

Bathula Pooja*, Ph Sobita devi, Bireswar Sinha, Nabakishor Nongmaithem, Rambabu Dasi, Paluru Pavani

Department of Plant Pathology, College Of Agriculture, CAU, Imphal – 795004

ABSTRACT

Maydis leaf blight (MLB) caused by the fungus *Cochliobolus heterostrophus* (Drechs.) Drechs. is a serious foliar disease of maize distributed widely in maize-producing areas throughout the world. The currently predominant form of *C. heterostrophus* is Race O, which can cause yield losses of up to 40 per cent. Damage is most critical if infection occurs prior to silking and if weather conditions are favorable for disease development during the reproductive growth stages. Host resistance is the most cost-effective and practical criteria for management of this disease. The typical symptoms caused by the bipolaris species were clearly distinct in maize. The typical symptoms caused by *B. maydis* were elongated strip lesions, or fusiform, elliptical lesions, and those caused by *B. zeicola* were narrow linear lesions. Herein, *B. saccharicola* was first reported on maize and caused subrotund lesions. This study provides useful information for disease diagnosis and management for Bipolaris leaf spot in maize. For the purpose of better understanding and finding out the suitable management practices a detailed study of the fungal pathogen including the different types of symptoms observed in the field, isolation and pathogenicity of the pathogen, host plants and suitable culture media to grow the fungus under laboratory condition was conducted in New Alluvial Zone of West Bengal. Five different media were taken to identify the most suitable media for maximum growth of the fungal pathogen to study the fungus in details under laboratory condition and Potato Dextrose Agar medium was found best for growing the fungus under artificial condition. Four cereals crops viz., Paddy, Wheat, Pearl millet and Sorghum were taken for host range study of the fungus and it is found that all of them may be the host plant of this fungal pathogen.

Keywords: Maydis leaf blight, Bipolaris, Diagnosis, Management, Identification

Automation in Floriculture: The future of flower production

Meikam Ichancha

Bidhan Chandra Krishi Viswavidyalaya, West Bengal

ABSTRACT

With the advancement of technology, automation has become a trend that has lots of functionality in the floriculture sector. Automation with robots and sensors have the capacity to make labour intensive work such as fertilizer application, irrigation, planting and harvesting to be handled proficiently. The use of robots with sensors, drones and augmented vision cameras have allowed the growers to monitor the climatic condition, predict presence of diseases and pest and implement effective management of greenhouse of crops and have also enabled to predict the harvesting stage of the crops thus providing a platform to harvest at the right stage. Due to automation and use of robotics in the field starting from land preparation to post harvest handling, 50% of the labor is reported to have been reduced. Crop loss are greatly reduced and quality is preserved since the proper harvesting technique is followed and done at proper time. The use of specialized sensors and its implementation on the fields that monitor climate variables has allowed the growers to anticipate possible problems by predicting crops, presence of pests, seasons with lack of light, reducing cost implementation and have reduced the prevalence of hazardous working condition. Sensor based rose harvesting robots, soil moisture sensor based augmented irrigation system in poinsettia and geranium have been developed for the ease of production and the studies have shown that automation of such have produced quality produce and greatly reduced the labour and consequently, reallocation was made possible. Sensor based augmented vision have made it possible to predict the perfect stage for harvesting gerberas. However, the growers in the country is restricted to use of traditional practice, much less the use of robotics in production.

Taking into account of the present scenario, full automation may face very significant challenges in overcoming traditional, cultural practices and economic problems.

Keywords: Rose, gerberas, poinsettia, automation, floriculture

System of Rice Intensification: Method to Sustainable Rice Production

Yumnam Sanatombi Devi

Department of Agronomy, SAIRAM, Imphal, Manipur

ABSTRACT

In conventional rice farming with excessive use of chemical fertilizers, pesticides and water can strongly be associated with many environmental concerns like methane emission resulting due to continuously flooded rice field, contaminated agricultural runoff that pollutes water bodies, chemical residues after harvested crop which can affect in the consumer's body and health issues of farmers resulting due to excessive use and unsafe handling of pesticides and fertilizers. Also increases weed problems and a shift in dominant grassy weeds resulting increases crop weed competitions. This resource intensive practice is also lowering the profit for the farmers in an increasing changing input/output market scenario. In this context, new technologies like SRI appears to have potential that saves inputs, protects environment and could improve productivity and soil health. The fact SRI produces a favorable environment to the crop for better growth of the crop. Rice exhibited the highest tillering potential under SRI method, due to lodging tolerance, greater stress resistance and wide ecological adaptability. Planting in square method with wider spacing might have resulted in profuse tillering under SRI cultivation, which might have facilitated plants for better utilization of the resources. System of Rice Intensification (SRI) is a set of principles and practices for increasing the productivity of irrigated rice by changing the current conventional management of plants, soil, water and nutrients. The practices includes developing nutrient rich and un-flooded nurseries instead of flooded ones, basically under SRI there was a wider spacing, less competition between plant to plant, more profuse growth of roots and effective tillers, applications of compost or manure rather than synthetic fertilizers and managing water carefully to avoid saturation of the rice plants root. Due to lower weed population and higher dry matter production that reduced competition of nutrient between crop and weeds that will increase the crop to grow well. SRI method of crop establishment improved in residual status of nutrient after the harvesting of rice due to require less standing water which leads to reduce nutrient loss through leaching. This methods help increase yields by over 30% while using 40% less water than conventional methods. Hence, it produces “more output with less input” it is a resource conserving technique of rice production that is good for farmers.

Keywords: System of Rice Intensification, Sustainable, Conventional.

***In vitro* Evaluation of Biocontrol Agents (Native *Trichoderma* spp.) against *Fusarium* wilt of pea**

W. Tampakleima Chanu^{1*}, Bireswar Sinha², Kota Chakrapani², Bijeeta Thangjam² and K. Sarada²

¹*Department of Agriculture, Himalayan University, Itanagar, Arunachal Pradesh-791111*

²*Department of Plant Pathology, College of Agriculture, Central Agricultural University, Imphal-795004*

ABSTRACT

Pea (*Pisum sativum* L.) is a very common nutritious vegetable grown in the cool season throughout the country. It is an excellent food for human consumption containing protein (7.2%), carbohydrates (15.8%), vitamin A and minerals. Among the soil borne diseases affecting pea, *Fusarium* wilt is considered one of the limiting factors for its low productivity. The present study was undertaken to know the effect of eight native *Trichoderma* spp against *Fusarium* wilt of pea in *in vitro*. Effect of volatile antibiotics produced by *Trichoderma* spp. against FOP were ranged from 18.57-62.37% where the maximum suppression of the growth of the pathogen was recorded with isolate NCIPMCAU-69 accounting 62.37%. Inhibition of radial growth of FOP by eight isolates of *Trichoderma* spp. with non-volatile antibiotics were ranged from 6.53% to 14.53% at 7.5% v/v concentration and from 6.08% to 20.97% at 15% v/v. The highest inhibition at 7.5 and 15% v/v concentration was recorded with the isolate NCIPMCAU-69 where the inhibition was potentially measured to the tune of 14.53% and 20.97%, respectively. Therefore, *in vitro* antagonistic potential of native *Trichoderma* spp. against FOP showed considerable radial growth reduction.

Keywords: Biocontrol, *Fusarium*, Non-volatile, Pea and Volatile.

Relevance of contract farming in agricultural development

Gargi Paliwal, Amardeep

Department of Agricultural Communication, Govind Ballabh Pant University of Agriculture & Technology, Pantnagar-263145, Uttarakhand., India

ABSTRACT

Agriculture is the backbone of Indian economy as 65 per cent of Indian population depends directly on agriculture. The major problems faced by farmers like price assurance, product marketability, elimination of intermediaries in the market and timely availability of production credit all this need some strategic interventions. A contract-farming is seen as a promising alternative that obliges a firm to supply inputs, credit, or extension in exchange for an agreement that fixes a price for the product and binds the farmer to follow a particular input and production method. Contract Farming is defined a form of vertical coordination between growers and buyer processors that directly shape production decisions through contract contractually specifying market obligation such as value, volume, quality and at times price, provide specific inputs and exercise some control at the point of production. (Little and Watts, 1994). Contract Farming in India is transforming towards cooperative contract model as reflected by entry of many multinational companies such as ITC Ltd., Cadbury, Global Greens, PepsiCo, etc. In general, Contractual arrangement between parties varies according to the depth and complexity of the provisions in each of the following three areas of Market provision: The grower and buyer agree to terms and conditions for the future sale and purchase of a crop or livestock product, Resource provision: The buyer agrees to supply selected inputs, which includes occasional land preparation and technical advice, Management specifications: The grower agrees to follow recommended production methods, inputs regimes, cultivation and specifications related to harvesting. Government has taken initiatives for Contract Farming which are Model Agricultural Produce Marketing Committee (APMC) Act, 2003 and Farmers (Empowerment and Protection) Agreement on Price Assurance and Farm Services Act, 2020.

Keywords: Contract Farming, Initiatives

Bionomics of South Indian *Callosobruchus chinensis* (L.) on Different Indian Pulses

Devina Seram¹, James Watt Haobijam^{1*}, Senthil Natesan² and John Samuel Kennedy³

¹School of Agriculture, Lovely Professional University, Punjab, India

²Centre for Pl. Molecular Biol. & Biotech., Tamil Nadu Agricultural University, Tamil Nadu, India

³School of Post-Graduate Studies, Tamil Nadu Agricultural University, Tamil Nadu, India

ABSTRACT

The pulse beetle, *Callosobruchus chinensis* L. (Coleoptera: Bruchidae) is known to attack pulses, an important nutritional commodity for India. Being a polyphagous pest, it can utilize diverse and alternate host seeds as a source of nourishment for their normal growth and development. In view of this point, this study was aimed to record the bionomics of *C. chinensis* on nine important pulses commonly grown in India, viz. *Vigna radiata*, *V. mungo*, *V. unguiculata*, *Glycine max*, *Cicer arietinum*, *Pisum sativum*, *Phaseolus vulgaris*, *Lens culinaris* and *Cajanus cajan*. The results of present investigations revealed that the oviposition of *C. chinensis* varied on different host pulses. Maximum oviposition was observed on pigeon pea (78 eggs) followed by cowpea (75 eggs) and the least number of eggs was laid on bengal gram (40.67 eggs). Maximum egg hatchability was observed in pigeon pea (91.62%) followed by cowpea (91.11%), green gram (86.09%), kabuli chana (85.52%) and bengal gram (85.04%) and the least was observed in french bean (51.76%). Per cent adult emergence amongst different host pulses was found to be highest in pigeon pea (85.46%) followed by cowpea (82.46%), kabuli chana (76.14%) and green gram (73.09%). Maximum mean developmental period (MDP) of *C. chinensis* was observed in soybean (38.00 days) and the minimum in pigeon pea (29.33 days). Mortality of the adult beetles on different hosts did not differ significantly. The longevity of the offspring differed significantly and the maximum longevity was observed in bengal gram (15.33 days). Amongst different host pulses, the highest per cent weight loss was observed in cowpea (18.70%) followed by pigeon pea (18.32%) and green gram (15.64%) which showed that these pulses are most susceptible to the attack of *C. chinensis*. From this study, it was observed that pigeon pea, cowpea, green gram and kabuli chana were most preferred by the South Indian *C. chinensis* population for their growth and development whereas french bean was the least preferred pulse.

Keywords: seed beetle, Indian pulses, hatchability, adult emergence, mortality, longevity

People should avoid consuming animal products to reduce risk for chronic disease. YES/NO

Seema^{1*} and Vatsala Saharan²

^{1*} *Department of Foods and Nutrition, I.C college of Home science, CCS Haryana Agricultural University, Hisar-125 004 (Haryana), India*

² *SGT University, Gurgaon*

ABSTRACT

Chronic diseases are the leading cause of death worldwide. Ischemic heart disease alone was responsible for about 9.43 million deaths in 2016. However, all cardiovascular diseases together cause around 17.9 million deaths annually worldwide. The prevalence of chronic diseases in the india and around the world is very high and not sustainable by most health care systems. While the etiology is complex, many chronic diseases are preventable through life long practices of adhering to healthy dietary patterns, engaging in physical activity and maintaining acceptable weight. Excessive attention to the animal versus plant binary food choice reflects society’s moral views on eating right. Consumption of animal products exposes humans to saturated fat, cholesterol, lactose, estrogens, and pathogenic microorganisms, while displacing fiber, complex carbohydrates, antioxidants, and other components needed for health. In the process, consumption of animal products increases the risk for cardiovascular disease, cancer, diabetes, obesity, and other disorders. When omnivorous individuals change to a plant-based diet, diet quality as measured by the Alternate Healthy Eating Index improves, and the risk of these health problems diminishes. Many researcher found that vegetarians have a lower prevalence of lifestyle diseases such as Obesity, Diabetes and hypertension than non-vegetarians. Many foods from both animal and plant origin can contain unhealthful components or lead to harmful biological effects, dependent on origin, preparation, dose, and general dietary context. Animal foods may have carcinogenic substances formed during heating (heterocyclic amines), microbial pathogens (E. coli), and hormones with untoward effects (estrogen). In conclusion, the complexities of human diets and metabolic health are much too great to allow for a binary categorization as “plants are good, animal foods are bad.” This simplistic approach lacks a foundation in science and cannot meaningfully inform dietary policy. We cannot safely eliminate a major food source, consumed by Homo sapiens throughout evolution, and hope to correct the resulting deficiencies with supplemented nutrients.

Keywords: Chronic diseases, Animal products, Supplemented nutrients

Current Status of Common Rust of Maize in India

Soumen pati*, Ph. Sobita Devi, Nabakishor Nongmaithem, Prajna samal, Kota Chakrapani

Department of Plant Pathology, College of Agriculture, CAU, Imphal – 795001

ABSTRACT

Maize (*Zea mays* L) is one of the most versatile emerging crops having wider adaptability under varied agro-climatic conditions. Globally, maize is known as queen of cereals because it has the highest genetic yield potential among the cereals. It is cultivated on nearly 150 m ha in about 160 countries having wider diversity of soil, climate, biodiversity and management practices that contributes 36 % (782 m t) in the global grain production. Among the maize growing countries India rank 4th in area and 7th in production, representing around 4% of world maize area and 2% of total production. During 2018-19 in India, the maize area has reached to 9.2 million ha (DACNET, 2020). During 1950-51 India used to produce 1.73 million MT maize, which has increased to 27.8 million MT by 2018-19, recording close to 16 times increase in production. Despite having such a huge productivity maize is affected by several diseases throughout years after years. Common rust is one of those diseases which is very common in India. Common rust of maize caused by *Puccinia sorghi* (Schw.) caused a yield loss of 12-60% and occurs more in spring maize growing areas. Rust pustules usually first appear in late June. Early symptoms of common rust are chlorotic flecks on the leaf surface. These soon develop into powdery, brick-red pustules as the spores break through the leaf surface. Pustules are oval or elongated, about 1/8 inch long, and scattered sparsely or clustered together. The leaf tissue around the pustules may become yellow or die, leaving lesions of dead tissue. The lesions sometimes form a band across the leaf and entire leaves will die if severely infected. As the pustules age, the red spores turn black, so the pustules appear black, and continue to erupt through the leaf surface. Husks, leaf sheaths, and stalks also may be infected. The fungus survives the winter as spores in subtropical and tropical regions; spores are carried long distances by wind and eventually reach the Midwest. Rust development is favoured by high humidity with night temperatures of 65-70°F and moderate daytime temperatures. The disease is usually more severe on seed corn. Differential spray schedule with Hexaconazole 0.1% revealed that, rust index was least in T5, i.e., five sprays of

3rd International Conference on “Global Initiative in Agricultural, Forestry and Applied Sciences for Food Security, Environmental Safety and Sustainable Development (GIAFAS-2021)”

Hexaconazole (30.25%) and the disease was completely free with T6, i.e., six sprays of Hexaconazole. The disease development started on 30 days (22.34% PDI) and increased progressively up to 90 days (88.56% PDI) and later on became stable. Among the inbred lines MI-12 and Indimyt-345 are highly resistant to common rust of maize and among hybrids viz., NK-6240, NK-61, NK-7305, CP-808, GK-3090, 30R77, CP-818, C-1945, JKMH-502, PAC-740, NK-121, Pro-311, DK-984 and Swarna registered resistant reaction under artificial inoculated field condition. A systemic fungicide, Tebuconazole 250 EC and non-systemic fungicide, Mancozeb + Phyton and botanical product, Neemazol F 5% were most effective which resulted in less per cent germination of uredospore. The ITK's viz; Jeevamrutha @ 20 per cent concentration caused significantly less per cent germination (22.69%).

Keywords: Maize, Present Scenario, Common rust, Symptoms, Disease Cycle, Management

Front line demonstrations on pigeon pea to enhance the production and minimize the yield gap

Mamta Singh¹, A K Singh² and KS Yadav¹

¹Krishi Vigyan Kendra, Sagar

²Krishi Vigyan Kendra, Jabalpur

ABSTRACT

Red gram or pigeon pea is commonly known as Tur or Arhar in India. It is second most important pulse in the country after chickpea. The ability of red gram to produce high economic yield under soil moisture deficit, makes it an important pulse crop in rainfed and dryland agriculture. India contributes for nearly 90 percent of world's total red gram production (Agriculture Market Intelligence centre, PJTSAU, Red gram outlook, February 2018). It is a rich source of protein and supplies a major share of the protein requirement of vegetarian population of the country. Deep roots improve physical properties of the soil and pulverise the soil as the plants shed large number of leaves, this biomass add organic matter to soil. Madhya Pradesh being the major pulse growing state in India, has a lot to contribute towards increasing pulse production and productivity in the country. To boost the production and productivity and to minimize the yield gap of red gram, Krishi Vigyan Kendra Sagar conducted front-line demonstrations at farmer's field. The technology demonstrations were conducted in Rahatgarh, Jaisinagar and Kesli block of Sagar district during 2016-17 to 2018-19. The demonstrations were conducted in an area of 80 ha. against local variety in three years. One hundred ninety-five demonstrations were conducted with active participation of farmers to demonstrated the improved technologies of pigeon pea in different village so as to establish production potential and expand the area under the crop in the district. The farmers practices were considered as control plot in all demonstrations. All inputs based on identified technologies. The data was collected from farmers field on plot basis. It was observed that the yield enhancement from 42 to 88 percent more as compared to farmers practices. The yield enhancement variation was received due to application of improved package and practices with use of high yielding medium duration varieties and improved plant protection measures. Economic analysis showed that net returns was higher than the local check and B:C ratio was 2.16, 3.46 and 2.15 in the year 2016-17, 2017-18 and 2018-19 respectively. The variation in yield was due to variations in rainfall in each year.

Isolation of volatile oil constituents and their antibacterial activity of *Skimmia lauriola* from tehri garhwal

Naveen Kumar

Department of Chemistry, K.L. D.A.V. (PG) College, Roorkee, 247 667 UK, INDIA

ABSTRACT

Aromatic plants have played key roles in the lives of tribal peoples living in the Himalaya by providing products for both food and medicine. The chemical composition of the essential oils of *Skimmia lauriola* (leaves) growing in Northern Garhwal, Himalaya has been studied. The wildy growing plants were collected from Dhanolti region of Tehri Garhwal. Essential oil was extracted by hydro distillation methods and analyzed by GC/MS. Thirty seven components were identified, accounting for 86.33% of the total oil. The oil is mainly composed of linalool acetate (26.40 %), L-linalool (14.18 %), β -phellendrene (9.03 %), prejeijerene (7.06 %), α -terpineol (6.25%), geranyl acetate (3.89 %) and myrcene (2.18 %). The essential oil was evaluated for antibacterial activity. The activity was more pronounced against *Pseudomonas aurens* with 8 mm zone of inhibition followed by *Escherichia coli* with 5 mm inhibition while *Bacillus subtilis* and *Staphylococcus aureginosa* were totally unaffected.

3rd International Conference on “Global Initiative in Agricultural, Forestry and Applied Sciences for Food Security, Environmental Safety and Sustainable Development (GIAFAS-2021)”

Keywords: Skimmia lauriola, Hydrodistillation, β -Phellendrene, Linalool acetate, Staphylococcus aureginosa

Yield enhancement of biosurfactant produced by *Meyerozyma guilliermondii* YK32 Dolly Rani* and Seema Sangwan

Department of Microbiology, CCS Haryana Agricultural University, Hisar, 125004, India

ABSTRACT

Biosurfactants are surface-active compounds produced extracellularly by bacteria, molds and yeasts using sources of biological origin. They have the ability to reduce solid-liquid and liquid-liquid interfacial tension. Biosurfactants are preferred over chemical surfactants for being eco-friendly, non-toxic, biodegradable, in various application including environmental fortification and agriculture. The present work aimed for the production of biosurfactants using different carbon sources *i.e.* glucose, soybean oil, olive oil, whey and molasses at the rate of 8% {(v/v)/(w/v)} using *Meyerozyma guilliermondii* YK32. Biosurfactant production was monitored in terms of oil displacement. *Meyerozyma guilliermondii* YK32 gave highest oil displacement measuring 7.5 cm with 8% olive oil as carbon source, followed by glucose (7.0 cm) and soybean (5.5 cm) after 5 days of incubation. Among industrial wastes/by-products, whey gave better oil displacement equaled to 5.2cm after five days of incubation. For yield enhancement two different hydrophilic industrial wastes (whey and molasses) and hydrophobic substrates (olive oil and soybean oil) were mixed in 1:1 ratio as following treatments: (*i.e.* 4% olive oil + 4% whey; 4% soybean oil + 4% whey and 4% molasses+ 4% whey) and studied for biosurfactant production after supplementation as carbon source in production broth. Replacement of olive oil, soybean oil and molasses with whey enhanced the biosurfactant production as monitored in terms of oil displacement from 7.5cm, 5.5cm and 4.6cm to 9.0cm, 6.5cm and 6.5cm, respectively, in case of *M. guilliermondii* YK32.

Keywords: Biosurfactant, oil displacement, industrial wastes, hydrophobic substrates, molasses, whey

Rhizodegradation – A promising Organic Phytoremediation technology Akrati Dev and D.K. Dwivedi

Department of Plant Molecular Biology & Genetic Engineering, Acharya Narendra Deva University of Agriculture & Technology, (Kumarganj), Ayodhya-224229 (U.P.), India

ABSTRACT

Rhizodegradation, also known as phytostimulation or accelerated rhizospheric biodegradation, is the biodegradation of pollutants in the soil by edaphic bacteria that is aided by the rhizosphere's natural characteristics. This region usually has a lot of microbial biomass and, as a result, a lot of microbiological activity, which speeds up the process. In comparison to other soil regions and microfloral communities, this region generally supports high microbial biomass and, as a result, a high degree of microbiological activity, which tends to boost the speed and efficiency of organic substance biodegradation within the rhizosphere. Plant roots have a tendency to improve soil oxygenation in their vicinity and discharge metabolites into the rhizosphere, which contributes to this. The release of sugars, amino acids, and other exudates from the plant, as well as the net root oxygen contribution, are thought to account for up to 20% of annual plant photosynthetic activity, with denitrifying bacteria, *Pseudomonas* spp., and general heterotrophs benefiting the most. Furthermore, mycorrhizae fungi linked with the roots aid in the metabolization of organic pollutants. This is significant because they have unique enzymatic pathways that allow them to biodegrade chemical compounds that would otherwise be impossible to convert purely through bacterial action. Furthermore, mycorrhizae fungi linked with the roots aid in the metabolization of organic pollutants. This is significant because they have unique enzymatic pathways that allow them to biodegrade chemical compounds that would otherwise be impossible to convert purely through bacterial action.

Keywords: Rhizodegradation, biodegradation, rhizosphere

Statistical analysis of farm Income Diversification among the valley and hill farmers of Manipur

Kh. Rishikanta Singh¹, N. Uttam Singh² and T. Basanta Singh¹

¹ ICAR Research Complex for NEH Region, Manipur Centre, Imphal

² ICAR Research Complex for NEH Region, Umiam, Meghalaya

ABSTRACT

Farm income diversification is a symbolic strategy for income sustenance and safeguard from risk associated with farming. Of the total 16 districts of Manipur state 8 district have been covered in the study comprising of 4 hill districts viz. Churachandpur, Chandel, Tamenglong and Ukhul districts and another 4 valley districts viz, Imphal West, Imphal East, Thoubal and Bishempur districts. From each district one village was randomly selected and primary data were collected from 240 respondents during the year 2019-20 using questionnaire of which 120 are from hill and another 120 from valley districts with 30 households from each village. Descriptive analysis, Simpson index of Diversification, TOBIT regression analysis using R-Software and Garrett Ranking technique were used in the study. Socio economic analysis of respondent farmers revealed that education level of valley farmers was higher as compared to hill farmers. Of the total respondents, 30.5 per cents were female farmers. Average cultivated area was 0.69 ha for hill area and 0.87 ha for valley area. Activities undertaken by the farmers were classified into two categories viz. farm and non-farm. It was found that the monthly income was higher for valley area which was Rs. 15,932 while for hill area it was Rs.12,110 respectively. For valley area, of the total income earn, farm income constitutes 66 per cent while for hill area it was 51 per cent, the remaining constituted non-farm income. Simpson index of diversification (SID) was used to calculate farm income diversification. The average diversification index was found to be higher for valley farmers which was 42.87 per cent compared to 33.89 per cent for hill farmers. The study revealed that overall there is medium or moderate level of farm income diversification in the state. Hill area has more number of farmers in low SID category compared to valley. Tobit regression analysis revealed that among the nine variables used in the regression only one variable ie, farmers’ social category was found to be positively significant at 5 % level. The coefficient of age was negative which reveal that as the age increases, risk bearing ability decreases which leads to decline in level of income diversification. Overall, the study reveal that there is a need for increasing farm income diversification in the state especially in hilly areas by incorporating additional income generating enterprise along with the cultivation of the main crop ie. paddy.

Antifungal activity of some plant extracts against *Colletotrichum falcatum* causing red rot in sugarcane

Anwar Ahmad¹, Jayant Mandal¹, Ajay Kumar¹ and Sujeet Pratap Singh²

¹Department of Plant Protection, Ch. Charan Singh University, Meerut.

²Uttar Pradesh Council of Sugarcane Research, Shahjahanpur.

ABSTRACT

Out of the many biotic stresses of the sugarcane, the *Colletotrichum falcatum* Went causes significant reduction in the quality and yield of susceptible sugarcane cultivars. Red rot can affect many commercial varieties during its course of infection and epidemiology. Usually, commercial fungicides are being used for the control of red rot disease which is harmful for human and agro ecosystem. There has been a rising concern on the research plant extracts for control of pest and diseases in agriculture which are less harmful to the human health and environment. Seven plant parts of six plants extracts namely *Allium sativum*, *Azadirachta indica*, *Allium cepa*, *Aloe barbadensis miller*, *Ocimum tenuiflorum* and *Tinospora cordifolia* were taken for the present study. The experiment was conducted as per standard poisoned food technique. Seven plant extracts were utilized to evaluate their comparative fungitoxicity against mycelial growth of *Colletotrichum falcatum* at various concentration levels of 1, 3, 5, 10, 15, 20, 30 and 60 percent in in vitro condition. Among six plant extracts, the extract of Neem was found more antifungal effects followed by Tulsi and Garlic in present study. These plant extracts could be used for the suppression of *Colletotrichum falcatum* causing red rot in sugarcane.

Keywords: Sugarcane, *Colletotrichum falcatum*, Plant Extract, Red Rot, Concentration, Per cent.

Isolation, Identification and Use of Fungus for Plant Growth

Ayushi Negi, Arjit Raj, Poonam Rani and Rohit Gautam

Department of Biotechnology and Microbiology, Meerut Institute of Engineering and Technology, MIET, Meerut

ABSTRACT

Microorganism for instant bacteria, fungus, are mainly considered as pathogens but some beneficial fungus such as *Trichoderma viride* found ubiquitously and can be used as plant growth promoter to provide defense to plants species from harmful pathogens. *T. viride* powder is selling in market as bio fertilizer and in very much practice these days. Therefore, in present study isolation and identification of *Trichoderma* species was done and bio fertilizer was made for further experimental purpose. For Experimental purpose soil samples were collected in bulk

3rd International Conference on “Global Initiative in Agricultural, Forestry and Applied Sciences for Food Security, Environmental Safety and Sustainable Development (GIAFAS-2021)”

from CCS Biotechnology herbal garden, MIET, Meerut .Then three treatments C, T₅, T₁₀ and T₁₅ in triplicates were prepared. Plant species *Vigna radiate* was selected for experiment as it can easily be grown and maintained. Pre-treated seeds of *V. radiate* were sown in different treatments and seed germination percentage was calculated along with shoot height, root length and vigor index after seed germination where parameters except seed germination percentage were measured and calculated on 3rd,5th and & 7th day. Results showed that seed germination percentage, shoot height, root length and vigor index were high in T10 treatment. On the basis of results it can be concluded that 10 gm *T.viride* in 1 Kg soil is better for the seed germination and growth parameters of *Vigna radiate*.

Keywords: *Trichoderma viride*, *Vigna radiate*, seed germination, seed Vigor index, biofertilizer

***In vitro* evaluation of antagonistic effect of *Trichoderma* spp. against *Fusarium oxysporum* f.sp. *lycopersici* causing *Fusarium* wilt of Tomato.**

Y. Premica Devi*, Ph. Sobita Devi, Bireswar Sinha, LNK Singh, Bijeeta Thangjam, Kota Chakrapani

Department of Plant Pathology, College of Agriculture, CAU, Imphal

ABSTRACT

Trichoderma species is one of the most promising free-living and diverse fungal microbial community known worldwide for their utility as bio-control agents in management of fungal diseases of crop plants. In the present study, 15 native *Trichoderma* isolates viz., *T. harzianum* (KU933468), *T. asperellum* (KU933475), *T. asperellum*(KU933473), *T. harzianum* (KU904458), *T. harzianum*(KU933469), *T. harzianum* (MH257330), *T. koningiopsis*(KU904460), *Hypocrea lixii*(KX0113223), *T. asperellum* (MH257327), *T. asperellum*(KT601340), *T. atroviride*(KU933472), *T. harzianum*(KU933471), *T. ovalisporum*(KU904456), *T. harzianum*(KU933474), *T. asperellum*(KU933476) were evaluated *in vitro* for their antagonistic effect against *Fusarium oxysporum* f.sp. *lycopersici* (FOL, the causal pathogen of tomato wilt). All the species considerably inhibited the growth of *Fusarium oxysporum*. It was found that out of the 15 *Trichoderma* spp. , *T. harzianum* (KU933468) (90.26%) showed the maximum extent of inhibition of mycelial growth followed by *T. asperellum* (KU933475) (86.67%). So, the application of the highly antagonistic isolates of *Trichoderma* spp. i.e *T. harzianum* (KU933468) and *T. asperellum* (KU933475) showed significant inhibitory effect on the wilt inducing FOL of Tomato.

Keywords: *Trichoderma*, Bio-control agents, *Fusarium*, Pathogen, antagonists

CRISPR Technology For Crop Improvement- A Review

Sindoora Nalajala*, M. Samuel Jeberson, E. Vani Divakara Sastry, M. Usha, Pravijith P

Department of Genetics and Plant Breeding, College Of Agriculture, CAU, Imphal-795004

ABSTRACT

CRISPR (clusters of regularly interspaced short palindromic repeats) technology is a non-transgenic genome editing tool that have a broad-spectrum application in various genetic applications such as in inducing biotic and abiotic stress tolerance in cultivars as well as to improve the growth, yield and quality parameters of the crop plants in question by inducing multiple desirable mutations at the specific sites of the genome. The defence mechanism was initially found in certain prokaryotes against the invading phage particles. This system consists of a specialised DNA sequence that are palindromic repeats with spacer sequence and a cascade protein (such as Cas9) which does the function of a molecular scissor to cleave double stranded DNA sites as specified by the crRNA transcript of the CRISPR sequence. These sites of cleavage would trigger the DNA repair machinery of the cell and the subsequent repair would lead to addition or deletions of DNA nucleotides or by filling the gaps by a certain set of nucleotides. The latter mechanism is modified by introducing the DNA template of choice so as to modify the gene expression product. The editing would be initiated only in the presence of PAMs (Protospacer Adjacent Motifs) at the site where the change is desired. This technology has a great role to play in the second green revolution and to attain food and nutritional security in the coming years.

Keywords: CRISPR, molecular scissor, biotic stress, abiotic stress, Protospacer Adjacent Motifs

Phytoremediation—a way towards sustainability

Jyoti Sharma*, Monika Menia, Monika Bonotra, Meenakshi Attri, Deepak Kumar

Division of Agronomy, Sher-e- Kashmir University of Agricultural Sciences and Technology of Jammu

ABSTRACT

With the development of industrialization and urbanization, the abundance of heavy metals in the environment has increased enormously during the past decades, which raised significant concerns throughout the world. The heavy metals which originates from either natural or anthropogenic sources such as use of phosphate fertilizers in agriculture, sewage sludge and pesticide application. These harmful metals effects can be lessened by a holistic approach of Phyto-remediation which can be used in large scale to remediate the contaminated land resources. Phyto-remediation is a plant-based approach, which involves the use of plants to extract and remove elemental pollutants or lower their bioavailability in soil. Plants have the abilities to absorb ionic compounds in the soil even at low concentrations through their root system. Plants extend their root system into the soil matrix and establish rhizosphere ecosystem to accumulate heavy metals and modulate their bioavailability, thereby reclaiming the polluted soil and stabilizing soil fertility. There are advantages of using phyto-remediation, which include economically feasible, environment and eco-friendly, and the harmful metals can easily be disposed thereby preventing erosion and metal leaching through stabilizing heavy metals, reducing the risk of spreading of contaminants and also improving the soil fertility by releasing various organic matters to the soil. Therefore, it is the need of the hour to remediate our valuable resources with due considerations for future generations. The use of potential energy crops in phyto-remediation programs would be useful to generate new bio-energy resources along with the remediation of contaminated soil. There are several energy crops in the world, but four promising and dedicated energy crops i.e. *Miscanthus*, *Ricinus*, *Jatropha*, *Populus* have primarily considered in this review to accomplish energy demands with their phyto-remediation potential. These four energy crops also act as potential carbon sink and offer an additional profit as carbon tax credits. Thus, the phyto-remediation crops provides a strategy for linking energy crops to resolve the sustainability issues and effectively solve the challenges of ever increasing contaminated sites and bio-fuel demands now and for future.

Keywords: Energy crops, Sustainable, Phyto-remediation, Heavy metals, Contaminated lands

Tilling, A Reverse Genetic Approach For Crop Improvement-A Review

M. Usha*, Pramesh Khoyumthem, Sindoor Nalajala, Pravijith. P

Department of Genetics and Plant Breeding, College Of Agriculture, CAU, Imphal-795004

ABSTRACT

Target Induced Local Lesions In Genomes (TILLING) is a non transgenic approach that is used to locate an allelic series of induced point mutations in a gene of interest. This method combines a standard and efficient technique of mutagenesis using a chemical mutagen such as EMS with a sensitive DNA screening technique that identifies single base mutations in a target gene. This method relies on formation of DNA heteroduplexes that are formed when multiple alleles are amplified by PCR and are then heated and slowly cooled. A bubble forms at the mismatch of two DNA strands which is then cleaved by single stranded nucleases. This technique which is high in throughput, low in cost and applicable to most organisms allows recognition of possible loss of function for a particular gene during early stages of development and is independent of genomic size, reproductive system or generation time. The major areas of application include functional genomics, DNA polymorphism assessment and genetic engineering. Furthermore, in crop breeding, TILLING allows not only the rapid, parallel screening of several genes but also a prediction of the number of alleles that will be identified on the basis of mutation frequency and library size (used in corn, wheat, rice, soyabean, tomato and lettuce).

Keywords: reverse genetics, DNA polymorphism, heteroduplexes, allelic series.

Dye yielding plants of goa-a qualitative study

Suvarnagouri Yadappanavar¹, Varsha S. Naik², K.S. Das³

¹*Dept of Textile and Apparel Designing, College of Community Sciences, Dharwad, Karnataka*

²*Goa College of Home Science, Goa University, Campal, Panaji, Goa,*

³*Gomantak Ayurved Mahavidyalaya and Research Centre, Shiroda, Goa.*

ABSTRACT

3rd International Conference on “Global Initiative in Agricultural, Forestry and Applied Sciences for Food Security, Environmental Safety and Sustainable Development (GIAFAS-2021)”

Goa, region belonging to Western Ghats is identified as one of the hot beds of biodiversity. Some of the plant species in this bio-diverse region have been exploited for meaningful returns. Present study aimed to explore the natural resources such as wild plants for potential natural dyes and utilize them in a sustainable way. Ethno botanical information, review of relevant literature on a total of 54 dye yielding plant resources belonging to 27 plant families of Goa along with their vernacular names, habit, part(s) used, nature of dyes and distribution, preparation of dyeing stuffs, use of mordants and specific dye utilization to serve various purposes, including several of the new dye resources was collected using an extensive survey method. Majority of the dye resources were dicotyledons. Most commonly utilized plant part for dye extraction was bark constituting 36% of plants recorded. The dye yielding time varied based on the part of plant used and the type of dye pot used for soaking. Survey findings revealed that the dye yielding plants were used for common local requirements such as insect repellence, disinfection, homemade juices/concoctions, however some of these plants had significant commercial values. *Acacia catechu*, *Lawsonia inermis*, *Punica granatum*, *Terminalia chebula*, *Woodfordia fruticosa* species were found to be used, particularly in perfume industries. There is a strong need felt to catalogue a library of dye yielding plants and familiarise people with indigenous methods of dye extraction and their use in sustainable ways.

Keywords: Plant dyes, Mordants, traditional knowledge, value based uses and conservation

Role of e-commerce in agriculture

Swati Mehta, Ashiana Javeed, Ranjeet Singh Bochalya and Meenakshi Attri

ABSTRACT

E-Commerce refers to the buying and selling between parties involved, in case of both services and goods. E-commerce is a huge part of the economy and is vital to businesses that sell their products or services online. E-commerce gives businesses the ability to reach more customers than traditional retail. Traditional agricultural value chains involve multiple intermediaries between farmers and consumers. Typically, farmers sell their produce at the farm gates to middlemen. Produce then passes through multiple intermediaries before reaching the end customer. As a result, farmers receive only a small proportion of the price paid by the end consumer as each intermediary in the value chain earns a margin. Agri e-commerce provides an opportunity to streamline the agricultural value chain and reduce inefficiencies in the distribution of farm produce. With so many people making their purchases online, it is the fastest-growing retail market. Electronic National Agriculture Market (e-NAM) constitutes a perfect example of e-commerce in the realm of agricultural marketing in India. It represents a new way for farmers to sell their produce to an array of buyers, including agri businesses, retailers, restaurants and consumers. Agri e-commerce also increases farmers' access to new markets and adds transparency to the value chain. Selling produce through online channels enables farmers to bypass intermediaries, leads to improved income of the farmers, reduces wastage and provides fresh produce to the customers. These benefits are particularly important in developing economies, where more than 97% of people are employed in agriculture and where the sector's contribution to GDP is in double digits. According to the Food and Agriculture Organization (FAO), a third of food produced for human consumption is wasted. Agri e-commerce services reduce post-harvest wastage through improving market efficiency. For instance, farmers selling fruit and vegetables through Frubana in Colombia record post-harvest losses of 3%, compared with the average of 58% for farmers that sell through traditional channels. As online platforms provide farmers with an alternative, farmers no longer have to choose between accepting low prices offered by middlemen, or searching for a last-minute buyer and increasing the risk of post-harvest losses. This shortens the time it takes for the produce to reach the customer, leading to lower risk of postharvest wastage as well as fresher and more nutritious produce.

Keywords: Agri e-commerce, Post-harvest losses, Consumers, Farmers and Agriculture marketing

Integrated Nutrient, Weed & Pest Management in Agriculture

Ashiana Javeed and Swati Mehta

Division of Agronomy, Sher-e Kashmir University of Agricultural Sciences and technology, Jammu

ABSTRACT

Research in Integrated nutrient, weed and pest management must take all aspects of the cropping system into consideration and evolve in a progressive manner. This approach must encompass the role of conservation tillage, knowledge of the critical period of weed interference, alternative methods of weed control, modeling of crop-weed interference. Organisms adapt to all control tactics used in agriculture. Unfortunately, agriculture does not proactively address pest problems until they cause considerable economic loss. Agriculture fails to address pest issues proactively not because of pest biology or ecology but because of the socioeconomic features of modern

3rd International Conference on “Global Initiative in Agricultural, Forestry and Applied Sciences for Food Security, Environmental Safety and Sustainable Development (GIAFAS-2021)”

agriculture. There are numerous definitions of IPM, although most of these focus on other pest complexes and typically are more appropriate for insect pests than for weeds. According to the 1988 U.S. National IPM Coordinating Committee, the primary goals of IPM programs are to reduce pesticide use and the subsequent environmental impact and to rely more on alternative strategies to control pests. Integrated weed management (IWM) comes under the umbrella of IPM with similar objectives of using multiple management tactics and incorporating the knowledge of weed biology and crop physiology into the weed management system. The acceptance of IWM by farmers will depend on their perceived risk to management, individual management capability, and environmental interactions that will influence the economic viability of the cropping system. Many of the IPM principles apply directly to weeds, while some require modification, particularly for organic weed management. Insect IPM programs are based to a large degree on economic thresholds and often on the use of specific biological controls against target pests. However, the dynamics of weed pressure differ significantly from those of insect pests or diseases in several ways. Because of the nature of annual cropping systems, weeds reliably occur every year; thus, farmers need to plan appropriate control measures as well as proactive cultural practices for each crop. While most insect or disease problems entail one or two harmful organisms for which specific biocontrols are often either naturally present or commercially available, weed problems usually result from the combined effects of several or many weed species. Economic thresholds are less useful in IWM than in insect IPM because weed density thresholds vary widely among the many possible weed–crop pairs. Thresholds become even more difficult to quantify when several weed species occur together and exert multiple effects on the crop.

Keywords: IWM, IPM, weeds, crops

Innovative intercropping of chilli + muskmelon on plastic mulching during summer for doubling the farmers’ income

Y. D. Pawar, S. H. Malve, D. A. Sadrasaniya and V. V. Prajapati

Krushi Vigyan Kendra, S. D. Agricultural University, Deesa, Dist. Banaskantha; Gujarat- 385 535

ABSTRACT

The existing government is willing to double the farmer’s income by 2022, but to achieve doubling farmer’s income might require novel strategies and some change in the policy stance. In India, majority of farmers are small and marginal; they are practicing sole cropping system. Presently, land fragmentation is also biggest issue in Deesa pocket of Banaskantha district. Thus, to combat this situation, Krushi Vigyan Kendra, Banaskantha-I (Gujarat), innovated and tested intercropping module of chilli + muskmelon (1:2) on plastic mulch with drip irrigation during summer season on farmers field. Results of the present innovative technology revealed that, main crop chilli produced 233.75 q/ha green fruit yield and muskmelon produced 302.60 q/acre of fruit yield in intercropping systems. Chilli equivalent yield was 364.37 q/acre with 1.81 land equivalent ratio (LER). Economical point of view, intercropping systems earned gross income Rs. 10.12 lakh per hectare as compared to sole crop of muskmelon (Rs. 4.05 lakh/ha) and sole chilli (Rs. 7.11 lakh) with traditional practices. This technology could be promising in terms of efficient utilization of land, minimum input involvement, reduce abiotic stress, higher productivity with more revenue generation and combating the land fragmentation issue in agriculture. This module has gained very much popularity within a short time among the farmers and covered 566.92 hectare area in one year.

Keywords: Chilli, economics, intercropping, LER, muskmelon, yield.

Precision farming –a resource conservation technology

Kanik Kumar Bansal*, Jyoti Sharma and Monika Menia

Division of Agronomy, Sher-e- Kashmir University of Agricultural Sciences and Technology of Jammu

ABSTRACT

Agriculture is the backbone of our country’s economy, which accounts for almost 30 per cent of GDP and employs 70 per cent of the population. In the post-green revolution period agricultural production has become stagnant, and horizontal expansion of cultivable lands became limited due to burgeoning population and industrialization. In 1952, India had 0.33 ha of available land per capita, which is reduced to 0.15 ha at present. So, it is essential to develop eco-friendly technologies for maintaining crop productivity. This could be achieved by diverting towards new technologies, precision agriculture for revolutionizing our agricultural productivity. Precision agriculture refers to the application of precise and correct amounts of inputs like water, fertilizers, pesticides etc. at the correct time to the crop for increasing its productivity and maximizing its yields. The benefits of so doing are twofold i.e the cost

3rd International Conference on “Global Initiative in Agricultural, Forestry and Applied Sciences for Food Security, Environmental Safety and Sustainable Development (GIAFAS-2021)”

of producing the crop in that area can be reduced and the risk of environmental pollution from agrochemicals applied at levels greater than those required by the crop can be reduced. Thus, it helps to improve input use efficiencies, economy, and sustainable use of natural resources, because it minimizes wastage of inputs. In other words, it may also be referred to ‘Site-Specific Farming’. It is a modern agriculture practice involving the use of technology in agriculture like remote sensing, GPS and Geographical Information System (GIS) for improving productivity and profitability. It enables farmers to use crop inputs more efficiently including pesticides, fertilizers, tillage and irrigation water. More effective utilization of inputs will bring in more crop yield and quality without polluting the environment and will result in sustainable agriculture and sustainable development. Hence precision agriculture is about doing the right thing, in the right place, in the right way, at the right time.

Keywords: Precision agriculture, Remote sensing, Site-specific farming, Yield and Sustainable development

Assessment of Variability, Heritability and Genetic Advance in Parthenocarpic Cucumber **Gurpiar Singh* and Navjot Singh Dhillon**

Department of vegetable science, Khalsa College, Amritsar, 143002, Punjab

ABSTRACT

To increase yield and its contributing traits, presence of variation is most significant for selecting the hybrids. Heritability and genetic gain show the extent of improvement occurred for particular trait. The present experiment was undertaken with the objective to estimate nature of variation and inheritance among different horticultural traits. Ten parthenocarpic hybrids were raised in Randomized Block Design replicated thrice and data were recorded on marketable yield and its related traits. The results showed that PCV and GCV estimates were high to moderate for vine length and number of female flowers per node. High heritability along with high genetic advance was recorded for internodal length, vine length, number of female flowers per node and total soluble solids suggesting that direct selection on the basis of these attributes will be rewarding for crop improvement in parthenocarpic cucumber.

Keywords: GCV, heritability, genetic advance, parthenocarpic cucumber, PCV

Study on Heterotrophic and Chemo-autotrophic Bacteria (nitrifying) in the Simulated Aquaculture System

Anjulata Suman Patre* and S. B. Gupta

Department of Agricultural Microbiology, College of Agriculture, Indira Gandhi Krishi Vishwavidyalaya, Raipur, Chhattisgarh, India

ABSTRACT

The present investigation was carried out at the Department of Agricultural Microbiology, College of Agriculture Raipur, Indira Gandhi Krishi Vishwavidyalaya, Raipur (C.G.) during the year 2017-2019 on bioremediation of polluted pond water for increasing fish production. In all, 8 treatments were replicated three times and used with Completed Randomized Design (CRD) was inoculation of the fish aquarium with the autotrophic and heterotrophic bacteria from the polluted fish ponds, i.e., T₁ (Control), T₂ Organic source of N (Urea 2 ppm) + No inoculums, T₃ Organic source of N (Urea 2 ppm) + Composite culture of heterotrophic bacteria, T₄ Organic source of N (Urea 2 ppm) + It was a mixture of the composite culture of autotrophic and heterotrophic bacteria, T₅ Organic source of N (Urea 8 ppm) + No inoculums, T₆ Organic source of N (Urea 8 ppm) + Composite culture of heterotrophic bacteria, T₇ Organic source of N (Urea 8 ppm) + It was a mixture of the composite culture of autotrophic and heterotrophic bacteria and T₈ Organic source of N (Urea 12 ppm) + Composite culture of heterotrophic bacteria. This study was carried out in twenty-four aquariums (volume 75x45x30 cm³) containing 70.00 liter water under greenhouse conditions. The soil and water samples from polluted pond water were taken for isolation of autotrophic and heterotrophic bacterial isolates, twenty-five samples from different locations of the Raipur area were collected. In the contaminated pond water, inoculation of autotrophic and heterotrophic bacteria positively affected ammonia concentration and heterotrophic bacteria (*Micrococcus luteus* and *Ochrobactrum pituitosum*) PS5 and PS16 isolate are performing best results in decreasing the ammonia concentration and increasing the nitrate concentration, respectively. Use of molasses 5 ppm along with the mixed culture of heterotrophic and autotrophic bacterial isolates found better for enhancing fish growth rate. Use of 1ppm skimmed milk found positively affected ammonia concentration at 15 DAI (0.28 to 8.41 ppm) and 30 DAI (0.275 to 6.44 ppm), respectively. The dual inoculation of heterotrophic and autotrophic bacterial isolates found better than single inoculation of autotrophic bacterial isolates wrt, organic N transformations to mitigate ammonium pollution in urban water bodies.

Keywords: Autotrophic Bacteria, Fish growth, Heterotrophic Bacteria, Isolation, Molasses, Skimmed milk

Agroforestry system adopted by farmers in hoshangabad district of madhya pradesh Nanita Berry, ITK Dilraj, Sourabh Dubey and Nikita Rai

Silviculture, Forest Management and Agroforestry Division, Tropical Forest Research Institute, Jabalpur, M.P.

ABSTRACT

An extensive field survey was conducted in Hoshangabad district of Central Narmada Valley agroclimatic zone of Madhya Pradesh. The aim of the study to evaluate the impact of adoption of agroforestry system by the farmer's of the study site. The informations of tree and crop species, planting pattern, reason for adoption, challenges faced by farmers after adoption of agroforestry system by conducting interview with questionnaire during 2019 - 2020. Results revealed that maximum farmers have adopted silvi-agri -horti system (68.39%), silvi-agri system (17.74%), horti-agri system (5.16%), silvi-agri-horti-pasture (3.23%), silvi-agri-oleri (2.90%) and silvi-agri-horti-oleri (2.58%) system on their field in Hoshangabad district. It is also reported that mostly farmers preferred *Tectona grandis* in silvi-agri, silvi – agri – horti - oleri, silvi – agri - oleri, silvi - agri – horti and silvi - agri - horti system while *Phyllanthus emblica*, *Mangifera indica* and *Psidium guajva* in silvi-horti-agri, silvi – agri – horti – oleri, silvi - agri – horti - pasture and horti-agri systems. Majority of farmers prefers bund and block planting on their field. Choice of tree-crop, tree planting pattern mainly depends upon the size of landholdings, knowledge of agroforestry and soil type, which will affects adoption of tree farming.

Keywords: Agroforestry system adoption, Central Narmada Valley, *Mangifera indica* , Silvi-horti, Silvi-agri system and *Tectona grandis*

Influence of different weed management practices on weed dynamics, yield attributes, yield and economics of black gram crop

Sooraj Chandra Pankaj*, R. R. Upasani, and Sheela Barla

Department of Agronomy, Ranchi Agriculture College, Birsa Agricultural University, Ranchi, Jharkhand 834006-India

ABSTRACT

A field experiment was conducted at Birsa Agricultural University, Ranchi, Jharkhand during rainy & winter seasons of 2015-16 and 2016-17. The experiment was laid out in randomized block design with 12 treatments i.e. haloxyfop 81 g/ha, haloxyfop 108 g/ha, haloxyfop 135 g/ha, haloxyfop 270 g/ha, fenoxaprop-p-ethyl 61.9 g/ha, quizalofop-ethyl 43.8 g/ha, imazethapyr 100 g/ha each applied at 20 DAS, pendimethalin 1000 g/ha, oxyfluorfen 100 g/ha each applied at 3 DAS, two mechanical, two hand weeding each performed at 25 and 45 DAS and weedy check, replicated thrice. Black gram *var.* Birsa Urd-1 was sown at 30 cm using 30 kg seed/ha fertilized with recommended level of nutrients N:P₂O₅:K₂O:Si.e. 25:50:25:25 kg/ha. Mustard *var.* Pusa-Bold was sown at 30 cm using 5 kg seed/ha fertilized with recommended level of nutrients N:P₂O₅:K₂O:S i.e. 80:40:20:20 kg/ha. The experimental field was mainly infested with *Eleusine indica*, *Echinochloa* spp. *Commelina* spp., *Alternanthera sessilis* and *Cyperus* species. Two hand weeding at 25 & 45 DAS recorded higher number of pods/plant, 1000-seed weight, seed yield and harvest index to the extent of 28.90, 16.10, 104.09 and 38.87 per cent, respectively as compare to weedy check i.e. 10.72 pods/plant, 33.80 g, 621 kg/ha and 19.15 per cent, respectively. However, application of haloxyfop 108 g/ha at 20 DAS recorded 10,513 and 13,878/ha higher net return compared to conventional practice of weed control i.e. two hand weeding at 25 & 45 DAS (26,789/ha) and two mechanical weeding at 25 & 45 DAS (23,421/ha), respectively and also recorded maximum B: C ratio (1.56).

Keywords: Black gram, Economics, Weed flora, Yield attributes, Yield

Potential of magnetite chitosan beads for removal of pesticides from water

Anirban Sil, Neethu Narayanan and Suman Gupta

Division of Agricultural Chemicals, ICAR-Indian Agricultural Research Institute, New Delhi, Delhi, India-110012

ABSTRACT

Over the years, consistent increase in pesticide contamination in water bodies has remained a matter of global concern. To remediate these contaminants from water, magnetite chitosan beads were synthesized using the simple co-precipitation protocol, and applied for removal of twelve most widely used pesticides (chlorantranilprole, clothianidine, azoxystrobin, acetamiprid, fipronil, imidacloprid, thiamethoxam, dinotefuran, thiacloprid, tricyclazole

3rd International Conference on “Global Initiative in Agricultural, Forestry and Applied Sciences for Food Security, Environmental Safety and Sustainable Development (GIAFAS-2021)”

and nitenpyram) from water. The prepared beads were characterized by Scanning Electron Microscope (SEM), Transmission Electron Microscope (TEM), and Fourier Transform Infrared Spectroscopy (FTIR). The pesticide removal potential of the prepared beads was found to be in the range of ~70-99% for most of the neonicotinoids (except thiacloprid and clothianidin) along with fipronil, chlorantraniliprole, and azoxystrobin. Further, the sorption experiments suggested that 10 mg of beads with 4 hours of contact time in a 5 mL of pesticide mixture solution at a fortification level of 1 µg/mL gives the optimum adsorption. The kinetic studies revealed that 1000-2500 µg/g was the maximum adsorption capacity of the composite and multiple steps including the intraparticle diffusion was involved in adsorption phenomena. Moreover, the regeneration and re-usability of the bead was valid up to three cycles with over 80% retention of adsorption capacity. Thus, such organic-inorganic hybrid materials will find huge applicability in future water remediation processes.

Keywords: Magnetic beads, Adsorption, Pesticides, Remediation, Water

Identification of co-expressed genes in different fungal species used as biopesticide

Niketa Chauhan¹, Prekshi Garg¹, Shalini Singh Visen², Prachi Srivastava^{1*}

¹Amity Institute of Biotechnology, Amity University, Uttar Pradesh, Lucknow Campus, 226028

²Food and Agriculture Foundation, Amity University, Uttar Pradesh, Lucknow Campus, 226028

ABSTRACT

Microbes are rich in diverse chemicals. With the development of microbe biotechnology, a considerable number of research activities are focused on bacteria and fungi-derived biopesticide. Biocontrol agents or biopesticides are exploited in a number of ways, some meddle with the mating process, while some other use plant extracts to trap insects. The present study deals with protocol to identify differentially expressed genes (DEGs) in the fungi *Beauveria bassiana* and *Metarhizium anisopliae* to study their expression pattern. The methodology involves conversion of raw FASTA files to gene count files in order to analyse differential gene expression. Case and control samples for *Beauveria bassiana* (SRR15043384, SRR15043385, SRR15043386) and *Metarhizium anisopliae* (ERR3089216, ERR3089217, ERR3089218, ERR3089219) were taken from NCBI SRA to perform transcriptome analysis. All the samples were subjected to quality check and trimming prior to alignment on Galaxy server. Further, reference genome was provided in order to generate count data for DEGs analysis. The DeSeq2 statistical method provided by Network Analyst tool was used for identification of DEGs. Results lead to the identification of total 437 significant genes in *Beauveria bassiana* and 204 genes in case of *Metarhizium anisopliae* at p-value 0.01. The results obtained from the study suggest that the significantly expressed genes in both the above-mentioned fungi can be a probable reason for their biopesticide activity.

Keywords: Differential gene expression, Biopesticides, *Metarhizium anisopliae*, *Beauveria bassiana*, Transcriptome analysis

Dehydration of Flowers: A new value addition for floriculture

Sanjana N Joshi and Veena S Jadhav

Department of Family Resource Management, College of Community Science, UAS Dharwad

ABSTRACT

Floriculture is presently considered as the most lucrative horti-enterprise to make profit in the global market. As the flowers are the utmost perishable horticultural farm produce Hence, value addition of flowers become very popular towards the expansion of floricultural trade by the are of preservation of flowers and the creation of novel products. The study was carried out during 2017-18. For the present study Dutch rose was selected and dried in three different drying techniques such as air drying, desiccant drying and microwave drying. Time taken for drying was recored. For physical analysis of qualitative parameters, an observation tool was used given by Dinesh (2000). The parameter taken for analysis were appearance, color and shape. In this study, four types of value-added dried flowers products such as potpourri, table mount, greeting frame and shadow box were developed and for evaluation of developed value-added products, thirty respondents were selected randomly and an observation sheet was used. ANOVA was used for statistical analysis. The result shows that, among three drying techniques, Dutch rose took less time for drying in embedding drying technique. Dutch rose recorded maximum mean score for retention of colour, appearance and shape in embedding drying technique. Potpourri scored highest for visual appearance, shape and overall acceptability by majority of the respondents among selected value-added dried flower products.

Keywords: Dutch rose, Drying techniques, Time, Qualitative, Value - added products

Biofortification a tool for enriching micronutrients in rice

Vijay Kumar S^{1*}, S. Pazhanisamy² and Rodda Chandana Devi³

¹Department of Agronomy, Annamalai University, Chidambaram, Tamil Nadu

²Department Agronomy, Dr.Rajendra Prasad Central Agricultural University, Pusa, Bihar

³Department of Soil Science, Dr.Rajendra Prasad Central Agricultural University, Pusa, Bihar

ABSTRACT

Malnutrition is a grave concern and is widely spread in most Asian and African nations. It has gained world attention due to its severe associated health problems. According to World Health Organisation (WHO), twenty million infants are born with a low birth weight each year. In recent years due to shifts in the eating habits by changes in lifestyle, urbanization and globalization, people started consuming junk food and ready to eat foods on a larger scale which generally have a high content of sugar, fat, salt and have low nutrient value in terms of protein, fiber, vitamins and mineral content. Consumption of these nutrient-deficient foods in due course leads to malnutrition and associated syndromes. Normally, Food crops (cereals and pulses) rich in nutrients could address deficiencies of micronutrients and thus provide a sustainable solution to global health issues. Micronutrient malnutrition has received increased attention in recent decades at a global level. Efforts have been made to combat them by increasing food production, supplementation, food fortification, and biofortification. Biofortification, enriching the nutritional quality of food crops using conventional plant breeding or modern biotechnology and agronomic approaches, is a balanced approach to overcoming mineral deficiencies. Micronutrient biofortification through agronomical practices is an alternative strategy to reduce rice grain's iron and zinc deficiency. Biofortification of rice plants by foliar spray of iron was an effective way to promote iron concentration in rice grains. Similarly, fortifying germinating rice plantlets with ferrous sulphate increases the iron concentration in germinated brown rice up to 15.6 times the control. Foliar application of zinc has been reported as an effective agronomic practice to promote rice grain zinc concentration and zinc bioavailability. Selenium, an essential trace element for human health and proved to be a potent antioxidant, has also been increased by applying selenate as a foliar spray or as fertilizer in rice. Hence, biofortification is an upcoming, promising, cost-effective, and sustainable tool for enhancing micronutrients in rice and other food crops.

Keywords: Agronomic approaches, Biofortification, Malnutrition, Micronutrients and Rice

***In vitro* evaluation and biochemical analysis of some plant extracts against green mould disease in Oyster mushroom (*Pleurotus sajor- caju*)**

Mallikarjun Channappa Chitti*, D.K. Sarmah and Sukanya Gogoi

Department of Plant Pathology, Assam Agricultural University, Jorhat-785013, Assam, India

ABSTRACT

The present study was undertaken to manage the green mould contamination (*Trichoderma* spp.) in oyster mushroom *in vitro*, by using aqueous extracts of nine botanicals (*Allamanda cathartica*, *Allium cepa*, *Aloe barbadensis*, *Azadirachta indica*, *Curcuma longa*, *Eucalyptus globulus*, *Laurus nobilis*, *Tagetes erecta* and *Zingiber officinale*) following poison food technique. Out of the nine botanicals tested at 15 per cent concentration, *A. cathartica* (66.28%) showed highest inhibition on mycelial growth of the contaminant compared to control which was followed, by *E. globules* (62.82%), *Z. officinale* (36.60%), *T. erecta* (33.53%), *C. longa* (31.50%), *L. nobilis* (30.60%), *A. cepa* (27.02%), *A. barbadensis* (25.97%) and *A. indica* (23.11%). The botanicals which showed mycelial growth inhibition above 60 per cent *viz.*, *A. cathartica* and *E. globules* were chosen for further biochemical analysis. The biochemical analysis included total alkaloid and total phenol content estimation. Results revealed higher alkaloid and phenol content in *A. cathartica* compared to *E. globulus*.

Keywords: Oyster mushroom, Green mould, contamination, *Trichoderma* spp., botanicals

Assessment of intraspecific crossability of cultivated Cowpea (*Vigna unguiculata*) varieties Bipramani Nameirakpam

Department of Agricultural Biotechnology and Molecular Biology, Dr. RPCAU, Pusa, Bihar- 848125, India

ABSTRACT

In this present study, a total of five accessions were selected for the crossability studies. A total of 15 crosses were made and pollen fertility, pollen germinability and pollen tube growth rate were studied after every 2 hours, 4 hours

and 6 hours of pollination. The above three parameters were used to develop the correlation matrix against the pod set to check whether there is any significant correlation. The maximum pollen fertility was observed in Arka Garima (96.79 %) and minimum in IC-33922 (90.35 %). In case of selfing, maximum pollen germinability after 6 hours of pollination was found in Arka Garima (71.11 %) and the minimum was in Kashi Nidhi (64.39 %). Longest pollen tube growth after 6 hours of pollination was observed in Arka Garima (309.97 µm) and shortest in IC-33922 (246.87 µm). The maximum number of pod set was obtained in Arka Garima (91.67 %) and the minimum in IC-33922 (73.47%). In case of crosses, maximum pollen germination after 6 hours of pollination was observed in Arka Garima X IC-33922 (61.29 %) and the minimum in PL-3 X Kashi Nidhi (52.83 %). The longest and the shortest pollen tubes after 6 hours were observed in Arka Garima X IC-33922 (250.25 µm) and Kashi Nidhi X IC-33922 (232.08 µm), respectively. The maximum number of pod set among crosses was recorded in Arka Garima X IC-33922 (70.59 %) and the minimum in PL-3 X Kashi Unnati (54.55 %). In both selfing and crossing, pollen germination and pollen tube growth increased in a constant rate. The data was subjected to correlation coefficient matrix which showed that there was less significant correlation between pollen fertility and pod set and high significant correlation between pollen germinability and pollen tube growth rate with the pod set.

Keywords: Crossability, pollen viability, pollen germinability, pollen tube growth, correlation

Understanding the effects of environment on the development of climate resilient crops
Bijeeta Thangjam*, Ph. Sobita Devi, LNK Singh, Bireswar Sinha, Kota Chakrapani, W. Tampakleima Chanu, Yengkhom Premica Devi and Tusi Chakma

Department of Plant Pathology, College of Agriculture, Central Agricultural University, Imphal-795004

ABSTRACT

Plant diseases occur where ever plant grows. The environmental conditions prevailing in both air and soil, and the contact of the pathogen with its host will have an effect on the severity of the disease. A susceptible host will not be infected by a virulent pathogen if the environmental conditions are not conducive for disease. Predicted climatic changes are expected to affect pathogen development and survival rates and modify host susceptibility, resulting in changes in the impact of diseases on crops. Changes in temperature, humidity and moisture, wind, light, soil pH, soil texture, host-plant nutrition, pollutants, CO₂ and ozone concentrations, precipitation, and drought affect the biology of pathogens and their ability to infect plants and their survival in natural and agricultural environments. Changing abiotic conditions will also affect the microclimate surrounding plants and the susceptibility of plants to infection. Accurate data on the environmental variables is basic to the understanding of the development of plant diseases. There is great need to fully understand the multidimensional nature of plant-pathogen interactions and produce disease-resistant crop plants that are resilient to climate change.

Keywords: Climate change, environmental conditions, susceptible host, virulent pathogen

New records of insect species damaging Moru Oak (*Quercus floribunda*) and their management

Neha Sharma, Pawan Kumar, Subhash Chander and Bhumika Kanwar

Forest Protection Division, Himalayan Forest Research Institute (ICFRE), Conifer Campus, Panthaghathi, Shimla (H.P.) 171013 India

ABSTRACT

Moru (Green) Oak (*Quercus floribunda*) is one of the Oak species widely distributed in the northwestern Himalayan ecosystems in the altitudinal range of 2000 to 2800m amsl. The Moru Oak is also vulnerable to insect pests attack. Sometimes these attacks transformed into the outbreak of pests. During the present investigations, surveys were carried out in the selected sites to assess the insect pest infestation during different seasons *i.e.* pre-monsoon, monsoon, post-monsoon using an augmented design. During this study different insect pests attacking different parts (Leaves, stem, acorns etc.) of Moru Oak were identified along with the extent and frequency of insect attack. Insects were collected in the field and geo-information of the study sites was also recorded. The study on life history of pests were undertaken both in the laboratory as well as in the field. Assessment of the damage by different insect pests on different parts of the Oak species was monitored and data on infestation status was recorded. The study led to the collection and identification of insect specimens belonging to the order Lepidoptera. The insect specimens were identified from Entomological Museum, FRI, Dehradun and consulting the related literature. It was observed that a Lepidopteron leaf defoliator, *Malacosoma indica* (Lepidoptera: Lasiocampidae) was heavily defoliating the

3rd International Conference on “Global Initiative in Agricultural, Forestry and Applied Sciences for Food Security, Environmental Safety and Sustainable Development (GIAFAS-2021)”

Moru (Green) oak and has been reported as a new record on Moru Oak. Insect specimens were arranged and preserved for permanent storage. Different control methods/ management strategies were used to control the insect pests of Oaks of western Himalaya. Natural enemies of insect pests of Oaks were also identified. Different control treatments (Insecticides and Bio pesticides) were tested in the lab including bio-control agents like *Chrysoperla* spp. and *Trichogramma* sp.

Keywords: Identification, Moru (green) Oak, Insect-pests, Biocontrol

Honeybee Enemies: A limiting factor in Beekeeping

Yashica Mehtani and Sunidhi Pilania

College of Agriculture, CCS Haryana Agricultural University, Hisar, India

ABSTRACT

Rearing of honeybees commonly called as beekeeping is one of the profitable area of agriculture which is mostly practiced as a full time occupation and a source of handsome income and table honey. Their rearing proves out to be very useful to the mankind as they not only provide us with cherished products like honey, beeswax, royal jelly, propolis, bee venom etc. but also plays a major role in pollination (more than 80% of crops are being pollinated by honeybees). However, we confront several issues and significant losses among beekeepers as a result of various enemy attacks and damage. Wasps and wax moths are the most serious threats to beekeepers, causing significant losses all over the world, thus gaining the attention of most researchers. Besides these two, mites, birds, hive beetles, ants, bears, and skunks are some of honeybees' other significant enemies. There are few minor pests viz., cockroaches, dragon fly, praying mantis, spiders, robber flies, etc. which too create nuisance to bee colonies. These pests cause havoc in honey production to a large extent. Controlling the attack of all of these pests is critical for improved honey production with considerably higher yield potential. A strong colony that can defend itself is the absolute necessity to protect honeybees from predators and pests. A secure hive with no cracks or holes in the hive bodies is another line of protection. According to IPM programme, use of non-chemical methods to keep pest population densities below their economic injury level should be preferred over chemical treatment. Appropriate chemicals in prescribed quantity and at proper time should be applied only when the other methods (cultural, mechanical etc.) prove insufficient.

Keywords: Beekeeping, Enemies, Pest management, Honey production

Phytoplasma on sesame: Distribution, symptomatology, diagnosis, etiology, host range, epidemiology, insect vectors, molecular characterization, transmission, and integrated management

T. Boopathi, M. Sujatha, M. Santha Lakshmi Prasad, P. Duraimurugan and K. Sakthivel

ICAR-Indian Institute of Oilseeds Research, Rajendranagar, Hyderabad-500 030, Telangana.

ABSTRACT

Sesame (*Sesamum indicum* L.), is an important oilseed crop originated in Africa and is possibly the oldest oilseed crop grown in many places around the world. Sesame seeds are good sources of edible oil (50%) and protein (20%). Sesame is considered by farmers as very significant as compared with other oilseeds because of its high nutritional value, high temperature tolerance and short duration. It is affected by many plant diseases, including those related to infection of phyllody. Phyllody disease in sesame is of serious concern in many sesame growing areas, and significantly diminishes its production, especially in warm environments causing up to 80% yield losses. The sesame phyllody has been mostly documented in African and Asian countries. Various types of symptoms for phyllody disease are reported to be associated with phyllody infected sesame plants viz., flowery phyllody, virescence, witches' broom, shoot tip fasciation, flattening of the shoot apex, intense leaf and flower bud proliferation; twisting and bending of main stem; ovipary and cracking of seed capsules, etc. Phytoplasmas causing sesame phyllody are microscopic and obligate parasites and have never been grown in an axenic culture. They are provisionally known as *Candidatus* Phytoplasma. Phytoplasma has a wide host range and can survive on other alternate hosts such as *Cicer arietinum*, *Brassica campestris* var. *toria*, *Croton* sp., *B. rapa*, *Arachis hypogaea*, *Trifolium* sp., *Parthenium hysterophorus*, *Crotalaria juncea* which serve as an inoculum. Psyllids, planthoppers, and leafhoppers are considered as vectors of phytoplasmas mainly which are categorised in the order Hemiptera. *Orosius albicinctus* (Distant) and *Circulifer haematoceps* (Mulsant and Rey) identified as vectors of sesame phyllody. *Hishimonus phycitis* Distant also transmits sesame phyllody. Phylogenetic tree, based on 16S rDNA to show the

relationships among sesame phyllody phytoplasma strains was constructed by neighbor joining method using Mega 7.0 software. GenBank accession numbers are obtained from NCBI on January 19 2021. The tree has clearly grouped the sequences in the 16SrI, 16SrII and 16SrIX subgroups. Sesame phyllody phytoplasma 16SrI strain sequences of India, Egypt and Thailand were associated in one group; 16SrII strains were grouped separately comprising the sequences from India, Iran, Taiwan, Turkey and Oman. 16SrIX strains of Iran (MW27256, KF774193 and MW272565) and Turkey (KC139791) sequences are clearly distinguished from the tree. This result clearly showed that the presence of different sesame phyllody phytoplasma strains and diversity in Indian subcontinent. Sesame phytoplasma has been effectively transmitted to the healthy plants from infected plants of sesame through *O. albicinctus*, grafting, and dodder. The most sustainable and viable alternative can be an integrated strategy by combining cultural, host plant resistance, biological, physical, and chemical methods. Sesame phyllody has become a potential threat to sesame cultivations. Hence, it has become necessary to take steps to reduce its further spread.

Keywords: Sesame phyllody, symptoms, insect vectors, molecular characterization, host plant resistance, management

Effect of bio-enriched farm yard manure (FYM) on growth, yield and economics of finger millet (*Eleusine coracana* (L.) Gaertn) under dryland condition

Shafnas, I¹., Vasanthi, B. G²., Altaf Kuntoji³ and Thimmegowda, M. N.⁴

Department of Soil Science and Agricultural Chemistry¹³

AICRP for Dry land Agriculture²³ UAS, GKVK Bengaluru- 65 Karnataka

ABSTRACT

Crop suffers from the slow release of nutrients from organic manures at initial stages, which may cause significant reduction in crop yield and farm income. This can be overcome by enrichment of organic manures with beneficial microbial culture and judicious combination of inorganic fertilizers with such enriched organic manures. Finger millet grown at AICRP for dryland Agriculture in reddish brown sandy loam soil during Kharif-2019 to study the effect of bio-enriched FYM viz., nitrogen fixers, phosphorus solubilizers, potassium solubilizers, PGPR and microbial consortia with 60 and 80 per cent RDF on growth, yield and economics of finger millet. Application of bio enriched FYM with microbial consortia + 80 per cent RDF (T10) recorded significantly higher plant height (86.38, 111.52 and 115.33 cm), number of tillers per plant (4.42, 5.20 and 5.42) and dry weight per plant (5.50, 15.05 and 27.27 g) at 60, 90 DAS and at harvest, respectively. Whereas, higher grain yield (2999 kg ha⁻¹) and straw yield (4274 kg ha⁻¹) resulted with T10 treatment, on par with application of 7.5 t ha⁻¹ enriched FYM (microbial consortia)+ 60 % RDF (2905 and 4183 kg ha⁻¹, respectively) and application of bio enriched FYM with microbial consortia + 80 per cent RDF recorded additional return of rupees 12683 per hectare over recommended use of fertilizers. Overall result showed that the bio enrichment of FYM with microbial consortia tended to reduced application rate of chemical fertilizer and thus microbial consortia along with 80 per cent RDF could be recommended for finger millet.

Keywords: Bio-enriched FYM, Dry land, Microbial consortia, Yield attributes

Genetic characterization and Population structure study of elite genotypes for upland cotton (*Gossypium hirsutum*) using microsatellite based markers

Pawan Kumar^{1*}, Somveer Nimbali¹, R. S. Sangwan¹, Neeraj Budhlakoti² and Sagar¹

¹Department of Genetics and Plant Breeding, CCS Haryana Agricultural University-125004, India

²ICAR-Indian Agricultural Statistics Research Institute, New Delhi-110012, India

ABSTRACT

Present study investigates the genetic diversity and population structure among the 96 genotypes panel of upland cotton. A diverse set of genotypes was selected from the complete germplasm and breeding material available at CCS Haryana Agricultural university, Hisar, Haryana. A total of 170 simple sequence repeat (SSR) were used in the present study and out of them, only 97 showed polymorphism using agarose gel electrophoresis. A total of 293 diverse alleles were generated by these 97 polymorphic markers which were used for further downstream analysis. Average number of alleles per SSR (3.021), gene diversity (0.551) and polymorphism information content (0.485) showed the genetic marker panel used in the present study was highly diverse, informative and all the genotypes were grouped in to three major clusters on the basis of maximum likelihood value of delta K obtained from

3rd International Conference on “Global Initiative in Agricultural, Forestry and Applied Sciences for Food Security, Environmental Safety and Sustainable Development (GIAFAS-2021)”

population structure analysis. Analysis of molecular variance also showed high genetic variance among the genotypes (97%) as compare to among sub-populations. The results of the present study showed that the genotypes in the different clusters differs significantly to another cluster and further genotypes with private alleles could be used in cotton improvement programmes.

Keywords: Population structure, AMOVA, Cotton, Simple sequence repeat (SSR), *Gossypium hirsutum*

Nutraceuticals' potential role in COVID-19

Pratibha Arya and Neelesh Kumar Maurya

Institute of Home Science, Bundelkhand University Jhansi (U.P.)

ABSTRACT

The SARS-CoV-2 pandemic has caused and threatens to inflict tremendous human suffering. Several lines of data on viral entry and spread in the host have converged in viral pathogenesis studies. There is a clear link between benign inflammation, ageing and metabolic diseases and SARS-CoV-2 infection and prognosis. Diet and nutraceuticals can help reduce viral invasion. So researchers researched antiviral nutraceuticals that work against other coronaviruses. These findings could be used to construct a diet that will improve innate immunity and act as preventative care against COVID-19. As a result of this review, a new perspective on the prevention and management of COVID-19 has emerged. Due to a limitation of clinical data, the research suggests that some nutraceuticals (such as omega 3 fats) and plant-derived substances (such as amino acids and probiotics), as well as herbal extracts, may be effective in the treatment of COVID 19. These include vitamins C, D, E, zinc, melatonin and other phytochemicals and function foods. These supplements prevent the SARS-CoV-2/COVID-19 pandemic. We study the scope to which these nutraceuticals and dietary supplements have potential in the perspective of the COVID-19 problem.

Keywords: phytochemicals, novel coronavirus, nutraceuticals, pandemic

Superoxide Dismutase as a biochemical maker for zinc stress in higher plants: A review

Kiran Bharti^{1*}, Naveen Kumar², Neha Pandey³, Narendra Kumar⁴, Neelam Dhiwan⁵

¹*Deptt. of Botany, K.L. D.A.V PG College, Roorkee, Uttarakhand, India*

²*Deptt. of Chemistry, K.L. D.A.V PG College, Roorkee, Uttarakhand, India*

³*Deptt.t of Entomology, University of Horticulture & Forestry, Bharsar, Uttarakhand, India*

⁴*Deptt. of Botany, Harsh Vidya Mandir PG College, Raisi, Haridwar, Uttarakhand, India*

⁵*Deptt. of Plant Physiology, CBSH, G. B. P UAT, Pantnagar, U.S. Nagar. 263145, Uttarakhand, India*

ABSTRACT

Reactive oxygen species can prove to be potentially harmful as these can cause an oxidation of biomolecules like proteins, lipids, chlorophyll and nucleic acids. The enzyme superoxide dismutase is very important enzyme of plant oxidative system. It acts as the first line of defense to scavenge reactive oxygen species. It catalyzes the dismutation of superoxide radicals to oxygen and hydrogen peroxide. In plants, three izozymes of this enzyme occur i.e copper/zinc, manganese, and iron forms. Therefore, the cupro zinc SOD isozyme profile of any plant can be used as marker for zinc stress. It becomes necessary to maintain zinc concentration in plant cells so as to protect them from oxidative stress. However the concentration of cupro-zinc superoxide enzyme has been found to be decreased in many crops under zinc deficiency which has been recognised as major problem in soil, plants and humans across the globe. As zinc is an essential micronutrient for both plants and animals it is important to assay its concentration in plants and eventually to find ways to overcome its deficiency.

Efficiency of different Manures on the growth and yield of Rice (*Oryza sativa*) under open condition

R Vijaykumar^{1*}, Biswarup Mehera², Neelam Khare¹, M.Sekhar³

¹*College of Forestry, Sam Higginbottom University of Agriculture, Technology & Sciences, Prayagraj, U.P*

²*Dept. of Agronomy, Naini Agricultural Institute (NAI), Sam Higginbottom University of Agriculture, Technology & Sciences, Prayagraj, U.P*

³*SDBIT, Dehradun, UK*

ABSTRACT

A field experiment was conducted at Forest Nursery and research Centre (College of Forestry) of Sam Higginbottom University of Agriculture, Technology & Sciences Prayagraj during *kharif* season 2019 with sixteen treatments replicated thrice in a randomized block design to efficiency of different Manures on the growth and yield of Rice (*Oryza sativa*) under open condition along with discussion on the experiment finding in the light of scientific reasons to understand the cause and effect relationship dully supported by finding . The data regarding growth, yield attributes, yield, soil physic-chemical parameter were recorded at suitable crop growth stage, respectively were the manures in the experimental field. Among the organic manure, green manure, green leaf manure with control treatments, result shows that significantly, The maximum performance of Grain yield observed inT₆ (44.41 q ha⁻¹) (50% Goat manure + 50% Green manure (*Crotalaria juncea*) followed by T₁₀ (43.55q ha⁻¹) (50% Goat manure + 50% Green leaf manure(*Pongamia glabra*) respectively and minimum Grain yield recorded in T₀ (37.06 q ha⁻¹) (control). The maximum performance of straw yield observed inT₆ (25.23q ha⁻¹) (50% Goat manure + 50% Green manure(*Crotalaria juncea*) and minimum straw yield recorded in T₀ (23.63q ha⁻¹) (control). The maximum performance of biological yield observed inT₆ (69.64 q ha⁻¹) (50% Goat manure + 50% Green manure(*Crotalaria juncea*) and minimum biological yield recorded in T₀ (60.70q ha⁻¹) (control). The maximum performance of harvest Index observed inT₆ (63.76%) (50% Goat manure + 50% Green manure *Crotalaria juncea*) and minimum harvest Index recorded in T₀ (61.06%) (control)) underopen condition

Keywords: Rice, Organic Manures, Green Manures, Green leaf manures Manure, open condition

Effect of organic substance, acid scarification and plant growth regulators on growth of tamarind (*Tamarindus indica* L.) seedling

Khushboo Tandon*, P.K.S. Gurjar, R. Lekhi and Deepa Soni

Department of Horticulture, College of Agriculture, RVSKVV- Gwalior

ABSTRACT

Tamarind (*Tamarindus indica* L.), or Imli is also called Indian Date. It belongs to the family Leguminaceae. Tamarind is a nutritious versatile fruit. The fruit consists mainly of pulp and seeds. Tamarind is valued highly for its pulp used in the preparation of food and beverages for domestic and industrial purposes. Tamarind seeds exhibit poor germination percentage even if exposed to favourable conditions of germination owing to seed dormancy. Plant growth regulators like GA₃ and NAA enhance the germination, growth and survival of seedlings. The experiment was conducted in Completely Randomized Block Design (CRD) with three replications, seeds were imposed to twelve different treatments in which GA₃ @ 200 ppm was recorded significantly under viz., maximum girth of stem at 30, 60, 90,120 and 150 days (1.93, 2.60, 2.60, 2.77 and 3.20 mm), maximum length of seedling at 150 days after sowing (67.53 cm), maximum root length at 150 days after sowing (26.70 cm), maximum no. of roots/seedling at 150 days after sowing (64.87). The minimum values were recorded in control. The maximum no. of leaves per seedling (3.73, 9.33, 11.00, 15.60 and 23.30) were recorded under T₃ GA₃ @ 300 ppm while maximum height of shoot 9.90, 14.73, 18.47, 30.53 and 41.70 respectively under T₁ GA₃ @ 100 ppm. It revealed that maximum length and more number of roots observed under the treatments because it absorbed more food material and might be increased the physiological activities of seedlings, which was essential for cell division or cell enlargement or both, because growth of the plant occurs by two processes i.e. cell division by mitosis which add new cells and elongation of already existing cells by enlargement of the vacuoles.

Keywords: *Tamarindus indica*, Seedling, Growth, GA₃, NAA, Cow urine

Effect of supplementation of Neem (*Azadirachta indica*) leaf and Ginger (*Zingiber officinale*) powders on performance of Giriraja poultry birds

S. R. Shegokar, S. D. Chavan, S. P. Nage

Department of Animal Husbandry and Dairy Science, Dr. PDKV, Akola

ABSTRACT

The present investigation was carried out at Department of A.H. & D.S., Dr. P.D.K.V, Akola in collaboration with Department of Poultry Science, PGIVAS, MAFSU, Akola to evaluate the effect of supplementation of Neem leaf and Ginger powder in the diet of Giriraja poultry birds. A 270 number of day old chicks of Giriraja Poultry birds were purchase from Government Hatchery, C.P.D.O., Mumbai. On arrival of chicks were weighted and distributed randomly into nine treatment groups viz, T₁ (control), T₂ (0.5% NLP), T₃ (1% NLP), T₄ (1% GP), T₅ (1.5 % GP), T₆

(0.5 % NLP + 1% GP), T₇ (0.5 % NLP + 1.5 % GP), T₈ (1 % NLP + 1 % GP), & T₉ (1 % NLP + 1.5 % GP) with 30 chicks in each group on equal weight basis. The chemical compositions of NLP determine were 87.21, 19.30, 17.55, 3.80, 11.24, 48.11 and Ginger powder 89.62, 12.30, 15.42, 2.80, 4.70, 64.78 per cent DM for DM, CP, CF, EE, Ash and NFE, respectively. The feed intake at 7th week recorded were 731.93, 712.37, 712.30, 701.50, 702.50, 695.43, 688.83, 682.22 and 660.60 g/bird under treatments T₁, T₂, T₃, T₄, T₅, T₆, T₇, T₈ and T₉, respectively. In concern regarding live body weights (LBW) at 7th week noticed were 879.60, 975.11, 1048.12, 1031.90, 1061.58, 1158.36, 1121.96, 12.09.30 and 1358.83 g / bird T₁, T₂, T₃, T₄, T₅, T₆, T₇, T₈ and T₉, respectively. These findings indicates that , 1% NLP + 1.5 % GP can serve as effective replacement for chemical based growth promoters. The present results regarding LBWG at 7th week were 208.92, 219.75, 255.78, 222.02, 203.93, 236.46, 267.17, 258.93 and 317.53 g / bird. This indicates that the birds with sole supplementation of NLP (T₂ - T₃) and GP (T₄ - T₅) had significantly lower gain in body weight of birds than birds maintained on combination treatments NLP + GP (T₆ to T₉). The better feed efficiency of 1.97 was obtained by offering 1% NLP+1.5 % GP (T₉) in diet followed by 1% NLP +1% GP (T₈) and 0.5 % NLP + 1.5% GP (T₇). The provision of 1% NLP + 1.5 % GP level (T₉) was significantly proved better to raise the dressing percentage to the level of 75.52% over that of their addition at lower level as dressing percentages were 71.59, 72.13 & 72.88% in T₆, T₇ & T₈. Moreover the differences in dressing percentages between T₆, T₇ & T₈ were non-significant. Besides this the dressing percentage of T₉ group was significantly higher over sole feeding of NLP (T₂- T₃) and GP (T₄- T₅).

Keywords: Azadirachta indica, Zingiber officinale, Giriraja, Poultry, Performance, Dressing

Effect of lactic acid fermentation on nutritional, anti-nutritional and bioactive components of finger millet (*Eleusine coracana* L.)

Sumaira Jan^{1*}, Krishan Kumar¹, Priyanka Thakur¹, Divya Chauhan¹, Qurat-Ul eain Hyder Rizvi¹, Naseer Ahmed¹ and Ajar Nath Yadav²

¹Department of Food Technology, Dr. Khem Sing Gill Akal College of Agriculture, Eternal University, Baru Sahib, Sirmour, HP-173101

²Department of Biotechnology, Dr.Khem Sing Gill Akal College of Agriculture, Eternal University, Baru Sahib, Sirmour, HP-173101

ABSTRACT

The finger millet (*Eleusine coracana* L.) flour was subjected to lactic acid fermentation by using two stains of *Lactobacillus* i.e. with *Lactobacillus brevis* and *Lactobacillus plantarum* at an interval of 12 (F12), 24 (F24) and 36 h (F36). The samples after drying were evaluated for their nutritional, anti-nutritional, minerals and bioactive components. The total phenolic content increased significantly ($p \leq 0.05$) from 1.07 mg/g in raw flour (RF) to 2.04mg/g (F12 by *L. brevis*) and 2.02 mg/g (F36 by *L. plantarum*). The antioxidant activity increased significantly ($p \leq 0.05$) from 74.35% (RF) to 91.73% (F36 by *L. brevis*) and from 74.35% to 92.04% (F36 by *L. plantarum*). Fermentation significantly ($p \leq 0.05$) increased the crude proteins from 9.10 (RF) to 13.13% (F36) in case of fermentation with *L. brevis* and from 9.10 (RF) to 10.23 % (F36) with *L. plantarum*. The crude fat contents decreased significantly ($p \leq 0.05$) from 1.20% (RF) to 1.19% (F36 with *L. brevis*). Similarly, the fat content also got reduced to 1.19% after 36 hours of fermentation with *L. plantarum*. Values for crude fibre decreased significantly ($p \leq 0.05$) from 5.67% (RF) to 3.49% (F36 with *L. brevis*) and from 5.67% (RF) to 3.67% (F36 with *L. plantarum*), respectively. A significant ($p \leq 0.05$) increase in mineral content such as Cu, Fe, Mn and Zn was observed during fermentation. Anti-nutrients such as phytic acid reduced significantly ($p \leq 0.05$) from 629.00 (RF) to 207.94 mg/100g (F36) during fermentation with *L. brevis* and 459.91mg/100g with *L. plantarum*. Similarly, values for tannin contents decreased significantly ($p \leq 0.05$) from 1.64 (RF) to 0.90 mg/g (F36) in case of fermentation with *L. brevis* and 0.72 mg/g with *L. plantarum*. The results concluded that fermentation could be the most effective way of improving the bioactive compounds, nutritional components and antioxidant activity of finger millet flour with significant reduction in anti-nutritional components.

Keywords: Fermentation, *Lactobacillus brevis*, *Lactobacillus plantarum*, bioactive compounds, antioxidant activity, antinutrients.

Seasonal study of stress in the Hill stream fish Golden Mahseer sampled from the Eastern Ramganga a tributary of Mahakali River

Arun Kalkhundiya, Jyoti Chand, Bipin Chandra Pathak

Fish Behavioural Research Laboratory, Department of Zoology, L.S.M. Govt. P. G. College Pithoragarh, India

ABSTRACT

Namik Glacier is a part of the Himalayas situated in the southeast of the Nandkote peak in Uttarakhand. It is the main source of the eastern Ramganga River of cold water resources. It is approximately 108 km long and covered most of the Pithoragarh district area. And it having the most diverse zone of fish fauna, out of this fauna mahseer (genus *Tor*) is one of them. Golden mahseer (*Tor putitora*) is utmost beautiful and diverse from other species on colour, head and large scale bases. It is the most valuable fish fauna in south Asia. But some anthropogenetic causes affecting to their breeding territory, which frequently distressing the behaviour. In the present study stress of the fish was quantified by cortisol Elisa Kit. Cortisol is a chronic marker of stress among vertebrates. The temporal concentration of cortisol showed a significant at $P < 0.05$.

Keywords: Cortisol, Glacier, Ramganga, *Tor putitora*, Fisheris

Nutritional and Cooking Characteristics of Selected Pigmented Rice Landraces of Kumaun Himalayas

Ajay Kumar*, Netrapal Sharma and Satpal Singh Bisht

Department of Zoology D.S.B. Campus, Kumaun University, Nainital, Uttarakhand

ABSTRACT

The present study was undertaken with the objective to evaluate the physical characteristics, nutritional quality, antioxidant and cooking properties of pigmented rice landraces of Kumaun hills India. All of the selected rice landraces were grown in traditional conditions. For assessment of nutritional quality Protein, iron, zinc, magnesium and oryzanol content was estimated. The protein, iron, zinc, magnesium and oryzanol content ranged from 7.2 to 13.1 %, 6.4 to 17.4ppm, 18.5 to 36.6ppm, 95.3 to 229.61ppm, 0.5 to 0.706 µg/mg respectively. For all of the cooking qualities evaluated in this study, all of the rice cultivars showed substantial diversity. The volume expansion ratio (VER) was varied from 0.3 to 3.1. The kernel elongation ratio (KER) was greater than 1.98 in all varieties except ATA landraces. On cooking ALA landraces exhibited the highest VER and sample 64 in KER 2.91 respectively. Based on the gel consistency (GC) test, the average GC values ranged from 29.17 to 82.59mm and varieties were categorized as hard, medium and soft. On the basis of alkali spreading, value (ASV) the variants were divided into three categories: low, medium, and high. Pigmented rice has a higher proportion of crude fibre, crude protein, minerals, and antioxidants than marked accessible white rice, according to the current study. Pigmented rice landraces have a wide range of nutritional benefits, making them a very useful super food that is gaining traction in the global market.

Keywords: Rice landraces, alkali spreading value, oryzanol, gel consistency

Distributions and infestation analysis of poplar leaf defoliator *Clostera* sp. (Lepidoptera: Notodontidae) in North western India

Jitendra Kumar and Arvind Kumar

Forest Entomology Discipline, Forest Research Institute, PO: New Forest-248006, Dehradun (Uttarakhand)

ABSTRACT

Poplars are among one of the fastest growing and noteworthy trees in temperate and subtropical zones of the world. In India, *Populus deltoides* hold a place of high significance and the most adequate tree species in the unique agroforestry system in Northern India. The superiority of wood often gets depreciated due to insect pest attack. *P. deltoides* is prone to infestation by a major insect defoliator, *Clostera cupreata* (Butler) (Lepidoptera: Notodontidae). More than 25% tree defoliation by *Clostera* sp. is known for significant reduction in the growth of poplar tree. The infestation of *C. cupreata* for several successive years of attack can reduce the plant growth drastically. The infestation of *C. cupreata* and the distribution of *Clostera* sp. in various poplar growing areas of Northern India is still not studied, we aim to estimate the infestation and the distribution of *Clostera* species in poplar field. Survey was conducted in the month of July and August to estimate the infestation in poplar and distribution *Clostera* sp. in the different poplar field of Uttar Pradesh, Uttarakhand, Punjab and Haryana of Northern

India. Random sampling was done and percentage of plant infestation in each selected poplar field and population share of *Clostera* sp. was observed. Result revealed that the distribution of *Clostera cupreata* and *C. fulgurita* was present in all four states, while *C. restituta* was recorded only in Punjab and some district of Haryana during the month of July and August. The poplar plant infestation by *Clostera* sp. was recorded in the month of July and August and maximum 39.33 % infestation was recorded in Saharanpur district of Uttar Pradesh, followed by 34.66 % Yamuna Nagar, Haryana, 30.5 % Haridwar, Uttarakhand and 24.83% Hoshiarpur, Punjab. The infestation and population share of three *Clostera* species was also recorded and resulted that in the month of July maximum infestation was of *C. fulgurita*, followed by *C. cupreata* in the states Uttarakhand and Uttara Pradesh, though in the states of Haryana and Punjab maximum infestation was recorded by *C. cupreata*, followed by *C. fulgurita* and *C. restituta*. In the month of August Maximum infestation was of *C. cupreata* in all the states, followed by *C. fulgurita* and *C. restituta*. It is concluded that *Clostera cupreata* is one of the serious and predominantly leaf defoliator in northwestern India. Hence this study gives a clear view about the infestation and distribution of *Clostera* species in different poplar growing field of North western India which help farmers to take up appropriate precautionary as well as management strategy to minimize the leaf defoliator infestation.

Keywords: *Clostera cupreata*, Infestation, Poplar, *Clostera fulgurita* and *Clostera restituta*

To demonstrate the effective concentration of *Isaria fumosorosea* against Rugose spiraling whitefly in infected Betel Vine Leaves

Kanuri Komala Siva Katyayani¹, Nelli Yashwanth Kumar²

¹Assam Agricultural University, Department of Plant Pathology, Jorhat, Assam, India.

²University of Bologna, International Masters in Horticultural Department, Bologna, Italy.

ABSTRACT

The entomopathogenic effect of *Isaria fumosorosea* against Rugose spiralling whitefly in infected Betel Vine (*Piper betel*) Leaves at an effective concentration. We collected the young infected leaves from betel vine under net house condition. The RSW have infected the plants and vines and collected data at *in vivo* condition, and leaves were picked and stored at the proper temperature at 24^oC. Sprayed *Isaria fumosorosea* 6ml/lit concentration on leaves which were maintained under insect rearing Petri plates. The instar to Adult stages was observed in each replication and followed treatments 2ml, 4ml, 5ml and 6ml. They controlled the nymphs under 6ml concentration, and also entomopathogenic Effect was marked on Nymphs followed by Adults. The Nymphs which affected by entomopathogenic fungus were placed on a PDA medium followed by three replication. The creamy white growth was observed after five days on medium at 28^oC ± in BOD Incubator and observed the sporulation under an electronic Microscope.

Recent Advances in Nutrient Management in Precision Agriculture in India

Priya, P.^{1*} and Ashoka, P.²

¹College of Agriculture, Hanumanamatti-581 115, Ranebennur taluk (UAS, Dharwad), Haveri District, Karnataka

²ICAR-Krishi Vigyan Kendra, Hanumanamatti-581 115, Ranebennur taluk (UAS, Dharwad), Haveri District, Karnataka

ABSTRACT

In India the conventional method of crop cultivation leads to increased cost of cultivation that in turn leading to decreased profitability. Blanket fertilizer application results into under-fertilization in some cases and over-fertilization in other. Such unbalanced and inadequate use of nutrient can decrease the nutrient use efficiency and profitability and may increase environmental risks associated with loss of unutilized nutrients through emission or leaching. In this context Precision agricultural techniques and technologies can go a long way in overcoming disadvantages of blanket recommendation. Recent advances indicate that use of optical sensors for nutrient management and these sensors are classified as multispectral and hyper spectral sensors. The Green seeker canopy sensor is a commercially available and widely used active optical sensor that emits red wavebands. Chlorophyll meters are reliable alternatives to traditional tissue analysis as plant N nutritional diagnostic tools. Most widely used chlorophyll meter is the hand-held Minolta SPAD-502. Apart from this LCC is also used to determine the N requirement in crops. Nutrient Expert and QUEFTS model are generally used computer-based decision support systems for precision nutrient management in crop production. The nutrient expert develops farmers' specific fertilizer recommendation based on 3-5 years previous yield, organic and inorganic fertilizers applied, attainable yield, soil fertility indicators, residue content and growing

3rd International Conference on “Global Initiative in Agricultural, Forestry and Applied Sciences for Food Security, Environmental Safety and Sustainable Development (GIAFAS-2021)”

environment information. Aerial imagery or site maps and the soil survey maps are also used for precision nutrient management plan. These tools, including knowledge of previous land use, are used to derive decisions for efficient nutrient management. Hence, these precision practices take care of spatial and temporal variability in nutrient supply and facilitates synchronization in plant demand and soil supply.

Keywords: Precision Agriculture, Spatial variability, Temporal variability, Sensors, Nutrient management

Applications of Internet of Things (IoT) in Agriculture

Priya, P.^{1*} and Ashoka, P.²

¹College of Agriculture, Hanumanamatti-581 115, Ranebennur taluk (UAS, Dharwad), Haveri District, Karnataka

²ICAR-Krishi Vigyan Kendra, Hanumanamatti-581 115, Ranebennur taluk (UAS, Dharwad), Haveri District, Karnataka

ABSTRACT

Since many years sensors were introduced in the agriculture operations. But the problem with the use of sensor technology was that we were not able to get the live data from the sensors. But with the introduction of Industrial IoT in agriculture, far more advanced sensors are being utilized. The sensors are now connected to the cloud via cellular/satellite network. Which lets us to know the real-time data from the sensors, making decision making effective. Internet of Things in agriculture has come up as a second wave of green revolution. The benefits that the farmers are getting by adapting IoT are two fold. It has helped farmers to decrease their costs and increase yields at the same time by improving farmer's decision making with accurate data. With increasing demands and shortage of labour across the globe, agriculture robots or commonly known as Agribots are starting to gain attention among farmers. Recent advancements in sensors and AI technology that lets machines to train on their surroundings have made agribots more notable. Drones equipped with sensors and cameras are used for imaging, mapping and surveying the farms. From the drone data, insights can be drawn regarding crop health, irrigation, spraying, planting, soil and field, plant counting and yield prediction and much more. IoT based remote sensing utilizes sensors placed along the farms like weather stations for gathering data which is transmitted to analytical tool for analysis. Farmers can monitor the crops from analytical dashboard and take action based on insights. Computer imaging involves the use of sensor cameras installed at different corners of the farm or drones equipped with cameras to produce images which undergo digital image processing. IoT in agriculture uses robots, drones, remote sensors and computer imaging combined with continuously progressing machine learning and analytical tools for monitoring crops, surveying and mapping the fields and provide data to farmers for rational farm management plans to save both time and money.

Keywords: Internet of Things, Agriculture, Agribots, Drones, Sensors, Computer imaging

Role of market access for food and nutrition security in India

Subodh Agarwal

Department of Business Management, CCSHAU, Hisar, Haryana, 125004.

ABSTRACT

Global food demand is increasing rapidly, its expected to reach 9.1 billion in 2050 and over 10 billion by end of the century. There are several factors for food scarcity but the food producers play an important role to meet the food demand and needs motivation by providing them good value of their agricultural produce. This will require major changes in agricultural policies. Lack of market access and nutritional insecurity continue to affect large no of people in the world. Majority of the farmers are small and marginal they don't have direct access to the market and are dependent on middleman as a result their share (producers share) in consumers rupee is very small. The global rate of under nourishment decreased significantly in past 7 years around 11% and according global nutrition report (2018) 46.6 million children were stunted and 25.5 million children were deceased alone in India. The per capita availability of food alone is not sufficient; equally important is the balanced diet or nutritional diet to meet their dietary needs and food preferences for an active and healthy life. The four major components of food security are food availability, access to food, utilization and its stability. These components can be strengthened by good governance, apt policy, capacity development of our local markets, majority of which are driven by small farmers. This could be implemented for poverty reduction, smallholder inclusion and increased food & nutrition security. It helps the farmers to cultivate and harvest fresh edible products round the year, if their produce is systematically marketed with proper value chain and value addition it will be benefit for both farmers and consumers in terms of market value and access to healthy and nutritious food respectively. The globalized world

with market reforms will allow these farmers to sell their produce to world market too, offering them optimum price, which will help in their inclusive development. Such policies will definitely help in fulfilling the sustainable development goal, end-hunger, achieve food security and improved nutrition and promote sustainable agriculture.

Purification of ligninolytic enzymes from *Pleurotus* spp. and their evaluation in dye decolorization

Asha Singh Rajavat^{1,2}, Neeraj Shrivastava², V. Mageshwaran¹, Ritu Vishwakarma¹, Abha Agnihotri², Anil K. Saxena¹, K Pandiyan^{3*}

¹ICAR-National Bureau of Agriculturally Important Microorganisms, Mau

²Amity Institute of Microbial Technology, Amity University, Noida

³ICAR-Central Institute for Research on Cotton Technology (CIRCOT), Mumbai

ABSTRACT

The dyeing process discharges around 10 to 15 % of colors in effluents, posing health and environmental threats. White-rot fungi are robust candidates in removal of various dyes as they are capable of degrading and mineralizing variety of highly hazardous, recalcitrant and organic pollutant compounds. In this study, *Pleurotus* spp., a white-rot fungus, was evaluated for its ligninolytic enzyme production potential using three agro-residues such as paddy straw, wheat straw and sugarcane bagasse under different incubation periods viz. 7, 14, 21 and 28 days. The results showed the maximum production of laccase (4596.89 ± 126.7 U ml mn⁻¹) and manganese peroxidase (1631.21 ± 54.1 U ml mn⁻¹) enzyme by *P. ostreatus* D-66 after 21 and 28 days, respectively from paddy straw. However, the highest lignin peroxidase activity (1082.32 U ml mn⁻¹) was observed from *P. Pulmonarius* D-79 after 21 days. The purification of laccase and manganese peroxidase from *P. ostreatus* D-66 showed 64.8- and 21.5-fold increase with yield of 54.0% and 17.9%, respectively. The lignin peroxidase purification from *P. Pulmonarius* D-79 resulted in 17.6-fold purification with a yield of 23.4%. Purified enzymes were stable at wide range of pH (pH 3.5 to 7.5) and temperature (30 to 50 °C). Decolorization potential of purified enzymes was evaluated using various synthetic dyes such as anthraquinone, azo, triphenylmethane and heterocyclic dyes. The highest decolorization efficiency (90.08%) was observed in purified laccase of *P. ostreatus* D-66 with decolorization of Remazol brilliant blue R and *P. Pulmonarius* D-79 (78.81%) with methyl green. Paddy straw was found to be a potential substrate for maximum production of ligninolytic enzymes from *Pleurotus* spp. and their purified enzymes could be effectively used to decolorize the synthetic dyes in textile effluents and other biotechnological applications.

Keywords: *Pleurotus* spp.; ligninolytic enzymes; Agro-residues; Synthetic dyes; decolorization.

Agricultural waste biomass utilization for energy production through gasification

Sunil L Narnaware* and N L Panwar

Department of Renewable Energy Engineering, College of Technology and Engineering, Maharana Pratap University of Agriculture and Technology, Udaipur- 313 001

ABSTRACT

Waste residues produced from agricultural activities have huge potential for renewable energy production by adapting appropriate technology which can provide a solution to issues like on-field decomposition, or burning creating environmental pollution. Biomass gasification is the thermochemical conversion technology that converts biomass into a gaseous product and is considered a mature technology. The gasification process takes place at an elevated temperature (900-1200 °C) and in a sub-stoichiometric environment (ER=0.25-0.40) to produce combustible gases called producer gas which has a low heating value between 1000-1200 kcal/Nm³. Producer gas can be used in conventional energy conversion devices like gas engines, turbines or more sophisticated equipment such as fuel cells for power generation whereas for thermal application furnaces and boilers can be used. Biomass gasification is regarded as renewable technology, provides flexibility for use of different biomass, can produce energy on a smaller to a larger scale, and has immense potential for employment in rural areas. The surplus agricultural waste biomass can be utilized for waste-to-energy to substitute and conserve fossil fuels through gasification. The present paper provides an overview of the gasification technology for the utilization of agricultural waste biomass for heat and power generation.

Evaluation of Brinjal Genotypes for yield and its contributing traits

S. Ganapathy and K. Nageswari

Vegetable Research Station, Tamil Nadu Agricultural University, (TN), India

ABSTRACT

An investigation in Brinjal (*Solanum melanjina* L.) was carried out to assess the performance of brinjal genotypes for yield and yield contributing traits at Vegetable Research Station (TNAU), Palur, Tamil Nadu, India. Observations were recorded for days to first flowering, plant height (cm), number of fruits per plant and single plant yield (kg). The experimental materials consist of the 65 brinjal genotypes including two checks (PLR 1 & PLR 2) were evaluated for yield and yield contributing traits in Randomized Block Design. The results revealed that, among the sixty five entries, the fifteen genotypes viz., GM B 004, GM B 018, GM B 020, GM B 022, GM B 032, GM B 067, GM B 071, GM B 083, GM B 093, GM B 114, GM B 132, GM B 187, GM B 188, GM B 211 and IC 136188 were recorded higher number of fruits per plant and single plant yield over the check variety PLR 2. Based on the overall performance of other agronomic favourable characters, among the 65 genotypes evaluated, only fifteen genotypes were identified as promising genotypes and will promote for further yield evaluation trials and Multi Location Trials for release new brinjal variety suitable for North East Zone of Tamil Nadu.

Evaluation of Sugarcane Clones for Yield and Quality Traits

S. Ganapathy* and R.S. Purushothaman

Vegetable Research Station, Tamil Nadu Agricultural University, Palur, Cuddalore District - 607 102, (TN), India

ABSTRACT

Development of varieties for different maturity groups is of paramount importance in sugarcane cultivation to realize higher recoveries in sugar mills. The proper choice of varieties, season and suitable agronomic technologies coupled with sufficient nutrient application play an important role in sugarcane production. Sugarcane being a long duration crop it occupies the land for 12-14 months. By developing varieties of eight months duration the productivity of the cane per unit area can be increased by raising three crops in two years. This also enables high sugar production by supplying cane for running the sugar factory for quite a long period. Keeping in this view, the present investigation was carried out at Sugarcane Research Station, Cuddalore during 2013-14 and 2014-15 for the evaluation of short duration sugarcane clones for quality and yield contributing traits. Observations were recorded for number of tillers (x1000/ha), number of millable cane (x1000/ha), cane yield (t/ha), Brix (%), CCS (%) and sugar yield (t/ha). The Experimental materials consist of six clones and three standards, in Advanced Yield Trial I (AYT I), Advanced Yield Trial II (AYT-II) and Advanced Yield Trial ratoon (AYT- ratoon) were evaluated for quality and yield attributes. The results from the AYT I, AYT II and AYT ratoon crops, revealed that, the clones namely C 29442 and C 29374 were found to be better forming clones, since they showed higher cane yield, CCS per cent, sugar yield, number of tillers per hectare and number of millable canes per hectare over the best check variety of CoC (Sc) 24. Hence these clones are to be promoted for further evaluation in Multilocation Trials and for release as a new short duration sugarcane variety.

Keywords: Sugarcane, Short duration, Cane yield, CCS %, Sugar yield

Effect of storage containers and treatments for longevity of fenugreek

Dileepkumar Masuthi, Jadhav Sulochana, Tatagar M.H., Sumangala Koulagi, Mahantesha B. N. Naika and Satish D

KRC College of Horticulture Arabhavi, UHS Bagalkot

ABSTRACT

In recent years, attempts have been made to replace synthetic pesticides with natural pesticides of plant origin which are cheaper, safer and eco-friendly, less persistent and more specific. Among the various methods followed, use of botanicals has been a traditional method and is being received much attention, to prevent the loss of seed during storage. So in this study more of botanicals are used. In this research programme longevity of fenugreek seeds is studied by using different containers like brown paper bag, polythene bag, cloth bag and different seed treatments like Tulsi leaf (5%), Yekke leaf powder (5%), Pongamia leaf powder (5%), Arappu leaf powder (5%), Boric powder

3rd International Conference on “Global Initiative in Agricultural, Forestry and Applied Sciences for Food Security, Environmental Safety and Sustainable Development (GIAFAS-2021)”

(1.5%), Cow dung flakes (1/4th flake) and Tulsi leaf (5%), Bavistin (1.5 g/kg of seeds) and control (without treatment). The experiment was conducted in Laboratory of Seed Science and Technology at Department of Biotechnology and Crop Improvement, Kittur Rani Channamma College of Horticulture, Arabhavi, University of Horticultural Sciences, Bagalkot (Karnataka) during 2017. Initially, seed treated with boric powder, control under cloth bag and control under brown paper bag showed maximum dry weight but at end of the storage boric powder and cow dung flakes (1/4th flake) and tulsi leaf (5%) seed treatment under cloth bag showed maximum seedling dry weight. In seed storage, seeds treated with cow dung flakes (1/4th flake) and tulsi leaf-5% and packed in cloth bag was effective for improving seed germination, vigour index, dry weight, seed treated with tulsi under brown paper bag condition showed minimum electrical conductivity, so these seed treatment and container are effective in extending the shelf life of seed, seed longevity, maintaining the storability and effective in controlling storage pest.

Improving quality of fenugreek varieties for incidence of powdery mildew disease Dileepkumar Masuthi*, Jadhav Sulochana, Tatagar M.H., Sumangala Koulagi, Mahantesha B. N. Naika and Satish D

KRC College of Horticulture Arabhavi, UHS Bagalkot

ABSTRACT

Fenugreek (*Trigonella foenum - graecum* L.) is an important leguminous seed spice crop. The seeds of fenugreek are rich in protein, gum and mucilage. It has long been recognized all over the world as a valuable spice for food and as a popular remedy for various ailments and physiological disorders. At present, very few varieties are available to suit to a particular region for commercial cultivation. Crop improvement and further exploitation in this crop is possible by identifying the potential genotypes in the existing germplasm. Selection of cultivars for a particular region is of much significance and shows considerable variability in several characters when grown under a particular environment. The experiment was carried out in the field during rabi 2016-17 and during rabi/summer 2017-18. The results of the field and laboratory experiments are presented here. Significant difference was found among the genotypes with respect to powdery mildew incidence. Kasuri methi showed (0.1%) resistance to powdery mildew followed by Gujarat genotype (3.5%). Whereas, Rmt-361 high susceptible to powdery mildew of (95.5 %). One genotype is immune (0%), five genotypes are resistant (1-25%), seven genotypes are moderately resistant (25-50%), eleven genotypes are susceptible (50-75%) and ten genotypes are highly susceptible (> 75%) to powdery mildew disease.

Agriculture farm bills

Shurti Gaba

Ct group of institutions, Jalandhar, Punjab, India

ABSTRACT

The effect of COVID-19 has significantly affected every citizen of every country across the globe in one way or the other. India is a country where the main population depends on agriculture sector. India might face a complicated situation because along with other sectors like tourism, education, hospitality, etc, even this sector will be affected. India announced Lockdown -Phase1 in the month of March 2020 where certain limitations were levied by the government. In addition to this in the same period three farmer bills'2020 were introduced which led to further aggravation of crisis situation. There are both pros and cons of all things. Similarly, the farms bills introduced might not really work well in future. In case if pandemic situation arises in future also then there will not be any stock yields left with govt in their mandi boards and the private sectors will play its own selfish role leading to high prices of the produces leading to increase in demand and less supply. This study aims to study the necessity for making arrangements for drafting of strategies and policies for the food safety during post-COVID-19 pandemic such offering grants and aids for agriculturalist and supervisory the rise of arrest of food and other essential commodities. Also, long-term plans like strengthening of the food supply chain is also the need of the hour. Every citizen should contribute his bit by joining hands together to make policy execution and every relief program across the country a success in times of need.

Global agriculture

Varun Kamboj

Ct Group of Institutions, Jalandhar, Punjab, India

ABSTRACT

Farmers around the world face and manage a wide range of enterprise-related risks. These risks are increasing due to a range of factors including globalisation, increased trade in agricultural products, and climate change, jeopardising agricultural enterprises and forcing farmers to adjust their production and management strategies. Here we present results of a systematic literature review, following PRISMA protocol, of farmers' perceptions of, and responses to, agricultural risks. Using data reduction method (factor analysis) and descriptive statistics, we analysed 197 studies and found that weather-related risk (55%), biosecurity threats (48%), and human risk (35%) are the significant risks perceived by farmers for their agricultural enterprises. Diversification of crop and animal production (28%) and pests and diseases monitoring and prevention (20%) were the preferred agricultural risk management strategies employed by farmers. Few studies have investigated socio-economic factors that explain risk perceptions (18%) or factors that influence how farmers manage agricultural risks (11%). The main barriers to successfully managing agricultural risks were limited access to information and formal low-interest loan systems, especially in developing countries. We identified a mismatch between perceived risk sources and risk management strategies, highlighting a need to improve understanding of why particular management responses are employed to address the various risks. This review suggests areas for future research to improve understanding of the perceptions of risks held by farmers, and to support efforts to manage and reduce these risks.

Ethnobotanical survey of medicinal plant species used by remote communities in District Chamoli, Uttarakhand

Chandramohan Singh*, Naresh Tariyal, Shubham Thapliyal, Anushri Kukreti

Department of Forestry, VCSG Uttarakhand University of Horticulture & Forestry, Bharsar, Pauri Garhwal, Uttarakhand

ABSTRACT

The Ethnobotanical Survey conducted in some remote villages of District Chamoli, Uttarakhand. The local people have great faith in traditional knowledge of plants and their uses. This study aimed to archive the Ethno-medicinal information on 57 plant species belonging to 37 families. Each plant species have the utility to cure a variety of health problems. Most plants has been collected during the spring season. The study elucidates important ethno-medicinal plants like *Aegle marmelos*, *Pinus roxburghii*, *Abrus precatorius*, *Adhatoda vasica*, *Allium nilagirica*, *Asparagus curillus*, *Bergenia ciliata*, *Bombax ceiba*, *Centella asiatica*, *Cinnamomum tamala*, *Gloriosa superba*, *Origanum vulgare*, *Phyllanthus emblica*, *Prinsepia utilis*, *Rhododendron arboreum*, *Sapindus mukorossi*, *Terminalia bellerica*, *Tino sporacordifolia*, *Zanthoxylum aromatum* of the area. Some cultivated plants like *Allium sativum*, *Citrus medica*, *Coriandrum sativum*, *Curcuma domestica*, *Juglans regia*, *Mentha arvensis*, *Prunus persica*, and *Trigonella foenum-graecum* were used in the study area. Species like *Bauhinia variegata*, *Berberis umbellata*, *Bombax ceiba*, and *Indigoferaa tropurpurea* are fuel wood providing species. *Principia utilis* and *Gloriosa superba* are psycho medicinal plants while *Allium sativum*, *Curcuma longa*, and *Coriander sativum* are used as spices. The study of the use of plants curing different health problems was engrossing. They were found to cure a variety of health problems such as bone fracture, muscular pain, cough, and cold, indigestion, cuts and wounds, rheumatic pain, eye pain, gall stone, nervine weakness, anemia, urinary problems, toothache, wound healing, diarrhea, skin problems, hair loss, and gastric problems.

Keywords: Ethno-medicinal plants, family, spring season, curing,

**Copper nanoparticles as an ameliorating agent for Paraquat toxicity in *Microchaete Sp.*
NCCU-342**

Durdana Yasin & Tasneem Fatma*

Cyanobacterial Biotechnology Lab, Department of Biosciences, Jamia Millia Islamia, New Delhi-110025

ABSTRACT

The cyanobacteria are important components of the paddy field as biofertilizers. However, they can be adversely affected by the excessive usage of herbicides particularly, Paraquat. The objective of this research is to minimize the paraquat stress and regulate the biochemical response of cyanobacteria by supplementation of copper nanoparticles as a mitigating agent.

Four treatments were evaluated: Control (without any treatment), herbicide stress (60µM paraquat), and supplementation of copper nanoparticles (50 µg/ml) with or without herbicide. Paraquat caused severe damage to the cyanobacterial cells. However, the damage was mitigated by supplementing stressed cyanobacteria with copper nanoparticles. It also enhanced pigments, proteins and phenol contents. Simultaneously, superoxide dismutase (SOD), catalase (CAT) ascorbate peroxidase (APX), glutathione peroxidase (GPX), and glutathione reductase (GR) activities also increased whereas electrolyte leakage, MDA and H₂O₂ content were decreased. Therefore, it can be concluded that copper nanoparticles can act as herbicide stress ameliorating agent in cyanobacteria by stimulating antioxidant mechanisms.

Keywords: Copper nanoparticles, Cyanobacteria, Paraquat toxicity, Oxidative stress, Anti-oxidant system.

Kalpa 1” A New late colour development apple bud sport originated from cv. Starking Delicious

Heerendra Prasad*, Rinkey Arya, Johnson Lakra, Sunny Sharma, Sunil Kumar and Jayesh Garg

Dr Y S Parmar University of Horticulture and Forestry, Nauni, Solan Himachal Pradesh (INDIA) 173230

ABSTRACT

Breeding in perennial fruit crops is time consuming process with relatively low success rate as compared with annual crops. Apple fruit coloration is painstaking as noticeable marker of maturity (early to late) and outer quality during the fruit breeding. The occurrence of spontaneous bud mutations in plants has often led to their subsequent development as commercial cultivars. Keeping in view, present investigation was undertaken to identify bud sports in apple (*Malus x domestica* Borkh.) in H.P. of India. In this study, based upon pre-selection criteria such as time of colour development and time of fruit maturation were implemented, one bud sport ‘Kalpa 1’ was identified as distinctive late in fruit skin development as compared to fully red coloured fruits on its mother tree of cv. Starking Delicious in H.P. India with red streaked fruits over yellow ground colour on the bud sports did not mature even at harvesting, respectively. Apart from the distinguishing character for which the bud sports were identified, they also differed in fruit shape and size, fruit firmness, fruit maturity, TSS, acidity and starch iodine test strain area. The identified bud sport has unique character of late maturity indices in H.P. this unique variety can be grown in other temperate regions of India with the same soil and climatic condition.

Keywords: Apple, Bud Sport, Kalpa 1, late colour development

Organic Farming for Sustainable Agriculture in India

Anju Bijarnia

Department of Agronomy, College of Agriculture, Ummedganj, Agriculture university, Kota

ABSTRACT

Organic farming can provide quality food without adversely affecting the soil’s health and the environment; however, a concern is whether large-scale organic farming will produce enough food for India’s large population. Certified organic products including all varieties of food products including basmati rice, pulses, honey, tea, spices, coffee, oilseeds, fruits, cereals, herbal medicines, and their value-added products are produced in India. Non edible

3rd International Conference on “Global Initiative in Agricultural, Forestry and Applied Sciences for Food Security, Environmental Safety and Sustainable Development (GIAFAS-2021)”

organic products include cotton, garments, cosmetics, functional food products, body care products, and similar products. The production of these organic crops and products is reviewed with regard to sustainable agriculture in India.

Today, the burgeoning population pressure has forced many countries to use chemicals and fertilizers to increase the farm productivity for meeting their ever-increasing food requirements. The prolonged and over usage of chemicals has, however, resulted in human and soil health hazards along with environmental pollution. Farmers in the developed countries are, therefore, being encouraged to convert their existing farms into organic farm.

Organic farming is completely a natural process; it takes from nature and gives back to nature. It is a modern way of agriculture which helps to produce disease free crops, vegetables, fruits etc. with its nutritional value intact. Organic farming is comparatively costly than conventional agriculture due to extended time period, expensive organic seeds etc., hence organic product are also expensive which helps in increasing the economy of country. Farmers in India are unaware of organic farming that is why they face many problems like fertility of soil, financial problem, market scenario etc.

Keywords: Organic farming, Soil health, Environment, Sustainable agriculture

Soil and Water Conservation in Agriculture

Monika choudhary

Department of Agronomy, Rajasthan College of Agriculture, Maharana Pratap University Agriculture and Technology, Udaipur

ABSTRACT

Conservation of soil and water resources is important for sustainability of agriculture and environment. Soil and water resources are under immense pressure due to ever increasing population thereby ensuing growing demand for food, fiber and shelter. Soil and water resources are being deteriorated due to different anthropogenic and natural factors.

Soil erosion is one of the several major deteriorative processes which results in deterioration of the soil. Soil erosion is removal of soil due to movement of water or air. Soil erosion may lead to the significant loss of soil productivity and thus may lead to the desertification under sever conditions. Water and wind are the major agencies which are responsible of soil erosion. Deforestation, over-grazing, mismanagement of cultivated soils, intensive cultivation and intensive urbanization are major factors triggering the soil erosion.

For sustainable agriculture and environment, it is pertinent for the protection of soil resources against erosion. Different control measures should be adopted to protect the soil resources against erosion. The concept of soil conservation cannot be materialized without conserving and efficient use of water resources. It is therefore pre-requisite that soil conservation practices should be adopted. Soil conservation practice include soil management, crop management, engineering, range management and forestry operation. The proper use of soil and water resources is necessary to ensure the future well-being of humans and of the environment.

Keywords: Soil, Water, Erosion, Conservation, Management

Integrated Weed Management in Herbaceous Field Crops

Roshan Kumawat

Department of Agronomy, College of Agriculture, Umedganj, Agriculture university, Kota

ABSTRACT

Current awareness about the environmental impact of intensive agriculture, mainly pesticides and herbicides, has driven the research community and the government institutions to program and develop new eco-friendly agronomic practices for weed control. In this scenario, integrated weed management have become mandatory. Weeds are commonly recognized as the most important biotic factor affecting crop production, especially in organic farming and low-input agriculture. In herbaceous field crops, comprising a wide diversity of plant species playing a

3rd International Conference on “Global Initiative in Agricultural, Forestry and Applied Sciences for Food Security, Environmental Safety and Sustainable Development (GIAFAS-2021)”

significant economic importance, a compendium of the specific integrated weed management systems is missing, that, on the contrary, have been developed for single species.

The main goal of this review is to fill such gap by discussing the general principles and basic aspects of integrated weed management to develop the most appropriate strategy for herbaceous field crops. In particular, a 4-step approach is proposed: (i) prevention, based on the management of the soil seed bank and the improvement of the crop competitiveness against weeds, (ii) weed mapping, aiming at knowing the biological and ecological characteristics of weeds present in the field, (iii) the decision-making process on the basis of the critical period of weed control and weed thresholds and (iv) direct control (mechanical, physical, biological and chemical).

Keywords: sustainable agriculture, integrated weed management, preventive weed control; mechanical weed control, physical weed control, biological weed control

BIOFERTILIZER MADE BY POULTRY FEATHER WASTE

Arpana Pal¹, Dr. Keerti Singh², Dr. Kunal Kishor³

1. *Dept of Microbiology, School of Basic and Applied Sciences, SGRRU, Patel Nagar, Dehradun- 248001, Uttarakhand; e*
2. *School of Basic and Applied Sciences, SGRRU, Patel Nagar, Dehradun,-248001 Uttarakhand;*
3. *Dept of Microbiology, School of Allied Health Sciences, Sharda Universty, Graeater Noida-201306, Uttarpradesh;*

ABSTRACT

It has been found over and over again that 99% Indian soil responds well to Nitrogen application which is a macronutrient for plant growth. Unless nitrogen deficiency is corrected application of other nutrients might not give fruitful results. To combat Nitrogen deficiency nitrogen rich fertilizers must be added. To explore nitrogen rich organic sources that can be utilized as bio-fertilizer becomes the need of the hour so as to prevent accumulation of hazardous chemicals in soil. One of the underused potential sources of nitrogen is poultry feather waste (PFW). Worldwide approximately 30.0- 3.08 lakh metric tons of PFW is generated that can be utilized for generation of various eco-friendly sustainable products one of which is the bio-fertilizer. Since chicken feather is rich in keratin protein it can yield potential micro and macronutrients along with nitrogen. PFW can be converted into value added bio-fertilizer. The use of PFW as bio-fertilizer would not only help in converting unwanted waste material to value added product but would also help in enrichment of soil rather than causing soil pollution.

Key Words: PFW-Poultry Feather Waste; Biofertilizer.

PRINCIPLES AND METHODS OF PEST CONTROL & THEIR SUPPORTING FACTOR OF POPULATION

Vinay Pandey and Khushboo Dubey

College of Agriculture Sciences, Teerthanker Mahaveer University, Moradabad

ABSTRACT

Pests are unwanted organisms because their activities run counter to those of the people living in the same ecosystem. This ecosystem is made up of a number of animal populations - two of which are pests and humans.

Together, these populations are called a community. The community along with biological pest food, hosts, prey plants, etc. and physical like hiding places, temperature, and humidity supporting factors are the components of an ecosystem - a basic, self-sustaining natural unit. Pest control takes place within this unit, to be effective it acts on the parts of the ecosystem.

The Pest control styles are set up to prevent, react to, eliminate or manage pests. Each style has advantages and disadvantages; the most complete style is pest management which involves the co-ordination of many elements depends on the nature of the infested site. Since pests are not evenly distributed in an ecosystem, an inspection is needed to locate them. To manage pests, the supporting factors of their population need to be identified and altered. When alteration alone is not sufficient, pesticides can be used to reduce the pest population to a tolerable level.

Management of Antifungal Treatment Through Herbal Preparations

Payal Sehgal¹, Dr. Keerti Singh²

Dept of Microbiology, School of Basic and Applied Sciences, SGRRU, Patel Nagar, Dehradun- 248001, Uttarakhand

ABSTRACT

Fungal pathogens create nuisance and cause various diseases that are of concern to human. Among various fungal pathogens dermatophytes are the group of pathogens that cause superficial infections in skin, hair and nails as they mainly require keratin for growth. In recent advancement era many of these dermatophytes have become resistant to antifungal drugs and remain a threat to human population. Also long time usage of antifungal drugs causes harm to human body. To overcome these pathogens some herbal preparations have proven to be effective. Essential oils such as neem, lavender, lemon grass etc. have proven to be effective against dermatophytes. As essential oils are cost effective remedy for treatment of dermatophytes and are cost effective also their use in long term leaves no side effects. Thus the problem of antibiotic resistance developed by the fungal pathogens can be overcome by using herbal preparations.

Keywords: Dermatophytes; Herbal Preparations

Effect of Ropinirole silver nanocomposite on the transgenic *Drosophila* model of Parkinson's disease

Falaq Naz^a, Rahul^a, Mahino Fatima^b, Swaleha Naseem^c, Wasi Khan^d, Amal C. Mondal^b, Yasir Hasan Siddique^a,

^a*Drosophila Transgenic Laboratory, Section of Genetics, Department of Zoology, Faculty of Life Sciences, Aligarh Muslim University, Aligarh-202002, Uttar Pradesh, India.*

^b*Laboratory of Cellular and Molecular Neurobiology, School of Life Sciences, Jawaharlal Nehru University, New Delhi-110067, India.*

^c*Interdisciplinary Nanotechnology Centre, Aligarh Muslim University, Aligarh-202002, India.*

^d*Department of Physics, Aligarh Muslim University, Aligarh-202002, Uttar Pradesh, India.*

ABSTRACT

Parkinson's disease (PD) is the second most common progressive neurodegenerative disease occurs mainly due to the loss of dopaminergic neurons in substantia nigra pars compacta. Due to the aggregation of α -synuclein in the form of Lewy bodies, PD patients exhibit motor dysfunction and increase in oxidative stress. In the present study the effect of Ropinirole silver nanocomposite (RPAgNC) was studied on the transgenic *Drosophila* model of PD. The exposure of RPAgNC to PD flies prevents the neuronal degeneration more effectively than the ropinirole alone. The results confirm that RPAgNC exerts more neuro-protective effect compared to dopamine agonist i.e. ropinirole as such in experimental PD flies.

Note: The study has been published in the Journal “Neuropharmacology”

Effect of kaempferol on the cognitive deficits and oxidative stress induced by the expression of alpha synuclein in the transgenic *Drosophila* model of Parkinson's disease

Rahul*, FalaqNaz, Yasir Hasan Siddique

Drosophila Transgenic Laboratory, Section of Genetics, Department of Zoology, Faculty of Life Sciences, Aligarh Muslim University, Aligarh, 202002, Uttar Pradesh, India.

ABSTRACT

The present study was carried out on the *Drosophila* model of PD that expresses wild-type human α S in the neurons. PD flies were allowed to feed on the diet having the final concentrations of 10, 20, 30 and 40 μ M of Kaempferol. Behavioural, biochemical histopathological parameters and molecular docking were performed. The results obtained

3rd International Conference on “Global Initiative in Agricultural, Forestry and Applied Sciences for Food Security, Environmental Safety and Sustainable Development (GIAFAS-2021)”

for activity pattern, aversive phototaxis and courtship behaviour showed improvement in the PD flies exposed to various doses of kaempferol. The exposures of PD flies to kaempferol also resulted in the increase of dopamine content and GSH levels and decrease in the GST activity, LPO, PCC and mean grey scale values in a dose-dependent manner. The immunostaining of brain sections of PD flies treated with different doses of kaempferol showed an increase in the number of TH+ cells in a dose dependent manner. Molecular docking revealed multiple modes of interaction between kaempferol and alpha-synuclein active site residues thus confirming the neuroprotective role of kaempferol.

AN ECONOMIC ANALYSIS ON PALMAROSA (*Cymbopogon martini*) CULTIVATION IN THIRUVANNAMALI DISTRICT OF TAMIL NADU

Radhakrishnan.S¹, Srinivasan.G., and Balu.D²

1. Ph. D Scholars and Associate Professor, Department of Agricultural Economics & Department of Agricultural Extension, Annamalai University,

ABSTRACT

Palmarosa (*Cymbopogon martini*) is tropical perennial grass which is being cultivated for its oil that smells like rose fragrance. The Palmarosa cultivating farmers faced many challenges including increase in cost of cultivation especially labour cost. At this juncture, the present study was carried out to analyse cost of cultivation of palmarosa in Thiruvannamalai district of Tamil Nadu with the following specific objectives: (i) to work out cost and returns of Palmarosa cultivation in the study area and (ii) to offer policy suggestions based on the results of the study. Thiruvannamalai district of Tamil Nadu was purposively selected for the study. From that Thandarampattu block which was higher in palmarosa cultivation was selected. Five villages from the block and 12 farmers from each village were selected randomly. In total, 60 farmers were selected and the primary data were collected through personal interview using a pre-tested questionnaire. From the study it is concluded that palmarosa is a profitable crop with less price fluctuations and ability to withstand natural calamities to ensure sustainable cropping. The study suggested that Government may encourage farmers through its departments to promote palmarosa cultivation in the study area and other suitable regions.

Keywords: Palmarosa cultivation, Economic analysis, Net return

Begomovirus: a future challenge for economically important crops

Mohammad Ansar

Molecular Virology Laboratory, Department of Plant Pathology, Bihar Agricultural University, Sabour-813 210, Bhagalpur, Bihar, India

ABSTRACT

Begomoviruses are the member of whitefly transmitted geminivirus which causes a rising threat to various cropping systems in both tropical and sub-tropical regions. A diverse symptom developed due to the viruses in various crop families causes economic loss globally. The viruses have been rapidly intensifying its host series and dispersing to new ecological regions. Since the last two decades extensive research approaches on viral genome, encoding amino acids, and interactions among whitefly and begomovirus has been carried out. The genome consists of either two components named as DNA-A and DNA-B (bipartite) or DNA-A associated with a satellite molecule (monopartite). Most of begomoviruses belong to the Old World (OW) which involves a single component associated with satellite molecules or betasatellite. Recently, natural occurrence of betasatellite in bipartite begomoviruses listed in various crops. Among the begomoviruses wide genetic variability has been revealed which enlighten understanding of virus taxonomy and their evolution. The variability in begomoviruses population and their adaptability to new hosts led by the recombination events in the viral genome. Year-round availability of preferred hosts for the whitefly and virus, breaking the disease cycle is quite challenging. At present, wider approaches are applied in different crops to prevent begomovirus infections by minimizing transmission rate. Additionally, to develop a variety against viruses, limited genes have been characterized to an extent where they may be used for introgression into suitable crop varieties through breeding programmes. In order to assure the prevention against the whitefly transmitted virus disease, analysing the critical epidemiological factors including whitefly dynamics may be the leading step to execute a sustainable disease management programme.

Key words: Begomovirus, betasatellite, leaf curl and whitefly

Reproductive biology and pollination ecology of *Berberis lycium* Royle: A highly valued shrub of immense medicinal significance

Susheel Verma*^{#1} and Ishfaq Ahmad Wani^{#1}

¹ Conservation and Molecular Biology Laboratory, Department of Botany, Baba Ghulam Shah Badshah University, Rajouri, J&K, India, 185234

ABSTRACT

Abstract: Study of reproductive biology and pollination ecology helps in understanding the life history patterns of species. Such a study brings to light the bottlenecks, if any, on account of which the individuals of the species are not able to reproduce in nature and ultimately helps in planning appropriate conservation strategies for the species under threat. The present study was aimed at examining the morphological and reproductive variance in *Berberis lycium*, a threatened ecological specialist growing within shrubberies and open hillsides of the North-Western Himalayas in India. *B. lycium* displays three different variants. Flowering period ranges from February to September. Pollen viability as reported on fluorescein diacetate and acetocarmine treatments was highest for variant I, while maximum pollen output was obtained for variant III. Pollen pistil interaction is brought by the movement of anther towards stigma. Fluorescence microscopy of hand pollinated club shaped stigma shows that the germinating pollen form a ring over the receptive adaxial surface. Pollination syndrome is entomophily. Variant II attracts a significantly large number of pollinators from diverse insect families. Breeding experiments reflect that plants are self-compatible and cross fertile. Reproductive output (% fruit set) was highest for variant II followed by III and I, respectively. This investigation helped to understand the effect of different biotic and abiotic constraints on the phenology and reproductive biology of the plant. The information generated so will enable conservationists to design appropriate strategies for its long-term survival and sustenance in nature.

Keywords: *Berberis lycium*; variants; North-Western Himalayas; mixed mating; entomophily; seed longevity; anther movement

Soil nematode diversity in rice fields during different seasons

Rawhat Un Nisa^{1*} and Ali Asghar Shah¹

¹ Nematode Biodiversity & Genomics Research Lab, BGSB University, Rajouri-185234, India

ABSTRACT

Soil nematodes play an important role in nutrient cycling but inhibits root growth of crop plants. The study aimed to investigate the changes in soil nematode biodiversity during the spring, summer, and winter seasons of a year in rice fields. Sampling was held at 24 sites of the rice fields where 216 soil samples during three seasons and 72 root samples during rice cropping were collected. The pH, moisture, nitrogen, and carbon content of the soil, and nematode diversity in both soil and root samples were observed during the three seasons. A total of 44 soil nematode genera were identified and there was a significant change in nematode abundance and soil characteristics during the three seasons. Among free-living nematodes, genera like *Diplogaster*, *Rhabditis*, and *Aphelenchus* may function as ecological indicators for soil health.

Keywords: Abundance; Community indices; Plant-parasitic nematodes; Prominence value

Mononchid nematodes' role in agriculture as biocontrol agents against plant-parasitic nematodes

Shaheen Majeed Wani^{1*}, A. A. Shah²

^{1,2} Nematode Biodiversity and Genomics Research Lab, Department of Zoology, Baba Ghulam Shah Badshah University, Rajouri-185234

Abstract:

Nematodes are worm-like metazoans that live mostly in soil. They are the most diverse and prolific metazoans on the planet. They outnumber other organisms in terms of both number and diversity of species. Plant-parasitic

3rd International Conference on “Global Initiative in Agricultural, Forestry and Applied Sciences for Food Security, Environmental Safety and Sustainable Development (GIAFAS-2021)”

nematodes, or phytophagous nematodes, assault and feed on plants, causing massive agricultural losses. Plant-parasitic nematodes are a favourite food of mononchid nematodes. Mononchids serve a critical role in regulating phytophagous nematode population dynamics. Because of their trophic relationship with these plant-parasitic nematodes, they reduce the population of phytophagous nematodes. Predatory nematodes have two functions: one is to inhibit plant-parasitic nematodes, and the other is to regulate soil nitrogen cycling. Members of the Mononchida group are carnivorous by nature and are the most effective biocontrol agents against phytophagous nematodes.

Key words: Nematodes; Mononchida; biocontrol; plant-parasitic; predatory

DNA barcoding aids in identification of adulterants of *Trillium govanianum* Wall.

ex D. Don

Shahid Ul Islam^a and Tanvir Ul Hassan Dar^{a*}

^aDepartment of Biotechnology, School of Biosciences and Biotechnology, BGSB University, Rajouri, Jammu and Kashmir, India

ABSTRACT

The correct scientific identification of the plant material is crucial to the safety and efficacy of herbal products. *Trillium govanianum* Wall. ex D. Don, a pharmaceutically prized medicinal plant species endemic to the Himalaya has been recently subjected to large-scale extraction in the wild due to increasing market demand. Consequently, adulteration and/or substitution of the traded material of *T. govanianum* with closely-related plants such as *Paris polyphylla* Sm. has become a quality control problem for the herbal industry. Therefore the present study aimed to (i) develop a reference DNA barcode of *T. govanianum* and its potent adulterant *P. polyphylla* for correct identification, (ii) and check adulteration of market samples of *T. govanianum*. Reference DNA barcode library of *T. govanianum* and *P. polyphylla* was successfully established, using Internal transcribed spacer (ITS), Maturase K (matK), chloroplast intergenic spacer (trnH-psbA), and ribulose-bisphosphate carboxylase (rbcL) regions. The ITS, matK and trnH-psbA were found to be ideal reference barcodes for *T. govanianum*, while ITS and trnH-psbA were suitable for *P. polyphylla*. All the trade samples (i.e. dried rhizomes), investigated during the present study, got putatively identified with the respective reference barcodes; and thereby indicating the ITS and trnH-psbA regions as the potential DNA barcodes for the identification of the trade samples/adulterants. The ITS region showed the highest mean intra- and inter-specific distances, which proves its high efficiency in differentiating closely related species. Phylogenetic trees were also constructed following the neighbor-joining (NJ) method, based on ITS, rbcL, and trnH-PsbA regions of *Trillium* and *Paris* species, which distinguished *Trillium* species from those of *Paris*. The availability of a novel DNA barcode for this important medicinal plant species will be helpful for correct identification of its raw plant material, checking illegal trade, and to regulate its sustainable collection from the natural habitats.

Keywords:-*Trillium govanianum*, Herbal products, Adulteration, DNA barcode, Illegal trade

Natural farming

Surbhi Prithiani, Harshita Mali

Department of Horticulture, Rajasthan College of Agriculture, MPUAT, Udaipur-313001 (Raj.)

ABSTRACT

Natural Farming is a chemical-free alias traditional farming method. It is considered as agro ecology based diversified farming system which integrates crops, trees and livestock with functional biodiversity. Natural farming, or the cultivation of crops or livestock using organic farming methods (but not necessarily with organic certification), is gaining a lot of attention due to its many benefits for humans and the environment. These include an eco-friendly cultivation process and chemical-free harvests, reasons enough for many farmers to exert extra time and effort in growing naturally farmed goods. Some of the other reasons farmers are adopting natural farming is produce nutritious crop, mitigate climate change, preserve biodiversity, protect water quality and many more. A set of principle guide natural farming execution on the farm: 1) farms should be based on poly cropping, where trees are integrated with various arable and perennial crop; 2) no synthetic agro-inputs- fertilisers, pesticide, or herbicides-should be applied; 3) soil should remain covered at all times and for the entire year using cover crops or mulch; 4) local seeds, which are less costly and more resilient than hybrids, should be used; 5) bio-stimulants, should be used as a catalyst agent to enhance microbial activities of soil, and botanical extracts for pest management; 6) minimal tillage; and 7) integration of livestock with crops for biological and economic synergies. The practice of natural

3rd International Conference on “Global Initiative in Agricultural, Forestry and Applied Sciences for Food Security, Environmental Safety and Sustainable Development (GIAFAS-2021)”

agriculture will not prosper without effort from the public. With the benefits mentioned above, it is safe to say that natural farming has done a lot of good things already, but the most important impact of natural farming as a form of sustainable agriculture is that it can protect the future of humanity. In India states such as Andhra Pradesh, Himachal Pradesh, Gujarat, Haryana, Karnataka and Kerala are promoting natural farming. Andhra Pradesh is the frontrunner among all states in implementing natural farming programme at a mass scale. In the last few decades, natural-farming movement led by farmers and civil society has spread to states such as Karnataka, Tamil Nadu, Maharashtra, among others. More than one lakh farmers have been estimated to follow natural farming practices in these states. Karnataka recently initiated implementation of zero budget natural farming (ZBNF) on a pilot basis in 2,000 hectares in each of the 10 agro-climatic zones of the state. Only a few farmers have been doing it at individual scale in other states. Andhra’s ambitious natural farming programme started at mass scale and has generated a fresh interest in other states to make ambitious targets. The solution to the emerging global problems is right before our very eyes. The initiative to take part and invest in good agricultural practices can efficiently improve and sustain our health, our environment, and significantly fight against challenging global issues such as climate change.

Keywords: *agroecology, organic, bio-stimulants, biodiversity*

Management of Antifungal Treatment Through Herbal Preparations

Payal Sehgal and Dr. Keerti Singh

School of Basic and Applied Sciences, Shri Guru Ram Rai University Dehradun (U.K) India

ABSTRACT

Fungal pathogens create nuisance and cause various diseases that are of concern to human. Among various fungal pathogens dermatophytes are the group of pathogens that cause superficial infections in skin, hair and nails as they mainly require keratin for growth. In recent advancement era many of these dermatophytes have become resistant to antifungal drugs and remain a threat to human population. Also long time usage of antifungal drugs causes harm to human body. To overcome these pathogens some herbal preparations have proven to be affective. Essential oils sch as neem, lavender, lemon grass etc. have proven to be effective against dermatophytes. As essential oils are cost effective remedy for treatment of dermatophytes and are cost effective also there use in long term leaves no side effects. Thus the problem of antibiotic resistance developed by the fungal pathogens can be overcome by using herbal preparations.

Keywords: Dermatophytes, Herbal Preparations

Propagation of Rose by Cutting Method

Aditya Mittal, Moinuddin and Ankit Semwal

School of Agricultural Sciences Shri Guru Ram Rai University, Dehradun Uttarakhand, India

ABSTRACT

Propagation of roses by stem cuttings is one of the simplest and most used methods to propagate this ornamental species. Indeed, most of old roses, English roses, miniatures and some rootstocks are commonly propagated by cuttings because they can root easily and, further, grow vigorously on their own roots. Every year, millions of roses are propagated by cuttings to support the needs of different sectors (e.g., production of rootstocks, cut roses, garden roses, and pot roses). In this article, we describe some of the main anatomical, ecophysiological and morphological aspects related to adventitious root formation in rose cuttings and the main internal and external determinants influencing rooting and final quality of rose starting material (rooted material ready to plant). Relevant strategies and developments in rose propagation by cuttings are presented and discussed. Roses are not that finicky that they are made out to be, with some basic steps they are easy to take care of. Rose care is easier than most flowering plants and anyone can grow them and enjoy their beauty. The basic requirement is to keep the soil moist and give it at least 5-6 hours of sun daily and prune smartly to promote more bud formation. It is also important to understand that rose plants are bushes and will always grow better in the ground. As far as plant issues go, watch out for powdery mildew, spider mites, and black spot. Most roses are simple to grow and easy to propagate by every home gardener. In growing plants from seeds there is a chance that the new plant is not an exact replica of the mother plant. Whereas in the case of propagating plants from cuttings, the new plant is an exact replica of the mother plant. You don’t have to be a professional gardener to propagate and grow your own rose bushes. Cuttings are parts of plant stem that is

3rd International Conference on “Global Initiative in Agricultural, Forestry and Applied Sciences for Food Security, Environmental Safety and Sustainable Development (GIAFAS-2021)”

taken to create a new plant via the process of rooting. The cuttings can be taken at different stages of maturity. Roses are not picky about the maturity of the stem cuttings and with proper care will root properly. The cuttings need to be planted as soon as the cuttings are taken so prep your planting spots in advance. It is important to use sharp shears or scissors to take cuttings from your rose plant. This is essential because it is important to minimize the damage to the cutting for a higher chance at rooting. The cuttings should be taken at a 45 degree angle and should be at least 10 inches long.

Key words: Cutting, Propagation method and Rose

Role of Biochar in Soil Nutrient Management

Priyanka Juyal and Moinuddin,

School of Agricultural Sciences, Shri Guru Ram Rai University, Dehradun (U.K) India

ABSTRACT

India produces about 435 million tons of agro-residues and from this very little amount of agro-residues most of its waste is not used. But with deep knowledge and correct scientific techniques we can convert this waste into an asset. And that is none other than Bio char. The term bio char refers to black carbon formed by slow pyrolysis of biomass under oxygen free environment. Bio char is better used as soil amendment as it improves water retention property and on the other hand bio char can be added to soil to improve its health and soil fertility. Bio char produced from animal manure contains more nutrients than wood based bio char. Bio char also contribute s to the mitigation of climate change by enriching the soil and reducing the need for chemical fertilizers which in turns lower green house gases.

Key words: Bio- char, agro residue, soil amendment, Biomass.

Influence of Nutrient Management Practices on growth and yield of Mustard (*Brassica juncea* L.)

Vaishnavi Sharma and Moinuddin

School of Agricultural Sciences, Shri Guru Ram Rai University Dehradun (U.K) India

ABSTARCT

The field experiment entitled “Influence of Nutrient Management Practices on growth and yield of Mustard (*Brassica juncea* L.)” was planned and conducted during *rabi* season of 2018-2019 with the combination of different nutrient management practices to evaluate their effect on the growth and yield of Indian mustard. The experiment consisted 8th treatments each replicated thrice and laid out in randomized block design. The result obtained from the experiment show that combination of different nutrient management practices significantly affected the growth parameter of Indian mustard such as plant height and number of branches per plant. The yield and yield attributes of groundnut were also influenced significantly by combination of different nutrient management practices. The maximum value of yield and yield attributes parameters *viz.* maximum seed yield, stover yield, test weight and harvest index were found to be higher under the treatment “T₆” (NPK 100% + S100%).

Key words: Growth, Mustard, NPK, S, and yiel

Bioefficacy of *Trichoderma* Species in Controlling Fruit Rot Disease of Chilli in Kashmir Valley

Anees Un Nisa¹, Shaiyestah Maqbool and Dr. Mohd. Yaqub Bhat*

Plant Pathology Lab. Department of Botany, University of Kashmir

ABSTRACT

Chilli (*Capsicum annum* L.) an important commercial crop grown globally is attacked by number of fungal diseases. Among all, fruit rot disease is the most serious fungal disease in Kashmir valley causing immense losses to the crop.

3rd International Conference on “Global Initiative in Agricultural, Forestry and Applied Sciences for Food Security, Environmental Safety and Sustainable Development (GIAFAS-2021)”

Although fungicides are being utilized for the management of diseases but to meet today’s pest management challenges, bio-control based strategies attract immense attention. This study was carried out to evaluate the efficacy of *Trichoderma harzianum* and *Trichoderma viride* against isolated fruit rot fungal pathogens (*Colletotrichum capsici*, *Alternaria alternata*, *Alternaria alstroemeria*, *Fusarium solani*, *Nigrospora sphaerica*, *Aspergillus flavus*) using dual plate culture technique. The antagonistic *Trichoderma* strains effectively suppressed the growth of fungal pathogens. *T. harzianum* showed the highest mycelial growth inhibition against the *N. sphaerica*. (81.25%), *C. capsici* (80%), *A. alternata* (78.57%), *A. flavus* (68.75%), *A. alstroemeria* (61.53%), and *F. solani* (52.85%). While *T. viride* showed the highest mycelial growth inhibition against *A. alstroemeria* (84.61%), *A. alternata* (78.57%), *N. sphaerica* (68.75%), *A. flavus* (68.75%), *C. capsici* (60%) and *F. solani* (55.75%).

Key words: *Capsicum annum*, fruit rot, *Trichoderma harzianum*, *Trichoderma viride*, mycelial growth

Elucidating cold induced oxidative stress effects on morphology and reproductive aspects of Pusa Sheetal cultivar of Tomato (*Solanum lycopersicum*) plants.

Nadia Gul^{1*} and Saima Aslam¹

¹ *Department of Biotechnology, School of Biosciences and Biotechnology, Baba Ghulam Shah Badshah University, Rajouri, 185234, India*

ABSTRACT

Global temperature upsurge leads to the intensification of cold extremes and drastic weather fluctuations globally. Cold temperature stress negatively affects the growth and overall development of plant species. Cold induced oxidative stress severely harms the morpho-physiological, reproductive parameters and metabolic networks in tomato plants. In this study, we investigated the effects of differential cold stress on morphological and reproductive characteristics of Pusa Sheetal cultivar. A direct correlation with increase in cold stress was observed on different aerial parts. Severely affected aerial plants parts include reduction in branching, height of plant, leaf size and number. In addition, our studies also correlated the effect of cold stress on induction of oxidative stress and its effects on growth and development. We estimated the effect of oxidative parameters by analyzing concentration of hydrogen peroxide (H₂O₂) and thiobarbituric acid (TBARS) in aerial parts of plant under investigation. We concluded that decreased temperatures i.e., enhancing cold stress resulted in increased accumulation of hydrogen peroxide (H₂O₂) and thiobarbituric acid (TBARS). Later byproducts impart severe effects on metabolism and growth of the plants, hence decline in crop yield. Understanding the changes due to cold stress on its growth and reproductive phases are important to manage the future of its agricultural productivity. The present study was carried out to evaluate the effect of low temperature regimes on some vegetative and reproductive behaviour of tolerant tomato genotype and develop screening method for low temperature tolerance. Our studies may pave way to initiate transcriptomic and proteomic studies to investigate possible strategies for the production of more cold stress tolerant form of this variety.

Keywords: Pusa Sheetal: cold stress; morphological; physiological; crop yield

Diversity of Plant Parasitic Nematodes associated with rhizosphere of Banana from different areas of District Rajouri, Jammu and Kashmir, India

Kaisar Ahmad Allie* Shaheen Majeed Wani and A. A. Shah

Nematode Biodiversity Research Lab, CBS, School of Biosciences and Biotechnology, BGSB University, Rajouri-185234

ABSTARCT

Nematodes are popularly known as round worms. They are ubiquitous in distribution, ranging in size from less than 1mm to more than 1m. A single hectare of humus rich soil harbors several thousand free living nematodes. Many are parasitic to plants and animals. According to the current literature free living nematodes are most diversified and abundant organisms in the soil. They are useful in nutrient cycling as well as in mineralization. Banana (*Musa* sp.) is the second most important fruit crop in India next to mango. Plant-parasitic nematodes limit the production of banana and is the major biotic factor that threatens the food security. In this study, diversity of plant parasitic

3rd International Conference on “Global Initiative in Agricultural, Forestry and Applied Sciences for Food Security, Environmental Safety and Sustainable Development (GIAFAS-2021)”

nematodes in the rhizosphere of banana from few areas of District Rajouri, Jammu and Kashmir was assessed. The major nematode genera associated with banana were *Pratylenchus*, *Helicotylenchus* and *Rotylenchulus*. Eleven species were found in the rhizosphere of banana. Among these, *Pratylenchus brachyurus* was most dominant with absolute frequency of 90%. This was followed by *Helicotylenchus gratus* and *Helicotylenchus dishystera* with absolute frequency of 82.5% and 77.5% respectively. The least dominant was *Hemicriconemoides cocophillus* with absolute frequency of 12.5 % followed by *Meloidogyne spp.* with absolute frequency of 10%. Highest prominence value was found in *Pratylenchus brachyurus* (6.501) and least was reported in *Meloidogyne spp.* (0.474).

Epiphytic lichen Diversity in the Pir-Panjal Region of Jammu and Kashmir, India: threats and conservation

Musarrat Fatima* and Mamta Bhat

Department of Botany, School of Biosciences & Biotechnology, BGSB University, Rajouri (J& K) – 185 234

ABSTRACT

The Pir-Panjal region of Jammu and Kashmir is one of the biodiversity rich areas of the Indian subcontinent. These unexplored high-altitude Himalayan regions need to be explored thoroughly for obtaining complete knowledge of the inhabiting biodiversity in general and lichen diversity in particular. As lichens constitute an essential part of the biodiversity, so documentation of their utilization by the local community for their welfare becomes imperative. Therefore, the present study is carried out to explore the epiphytic lichen diversity of the Pir-Panjal region. Besides, the rich diversity of lichens is under severe threat due to various anthropogenic causal factors operating in the region. Therefore, the conservation measures needs to be adopted to safeguard the epiphytic lichen diversity of the region.

Keywords: Pir-Panjal, Epiphytic, Lichens, Biodiversity, Conservation

Potential underutilized fruit crops of Eastern region of India

Kumari Karuna¹ and Abhay Mankar^{2*}

¹Department of Horticulture (Fruit & Fruit Tech.) B. A. C., Sabour, Bhagalpur, Bihar, India

²Directorate of Extension Education, BAU, Sabour, Bhagalpur, Bihar, India

ABSTRACT

The crops which have potential to bear commercially but not grown and exploited widely are known as potential underutilized fruit crops. It's potentiality varies from place to place. It requires publicity of these fruit crops which is suitable for a particular region. These crops have several advantages. They are easy to cultivate locally because these are hardy with prevailing climatic condition. Generally, these crops are grown locally, so it is cheap and easily available. Amongst underutilized fruit crops of that particular area, most of them are good source of vitamins, minerals, anti-oxidants and other nutrients like proteins, fats and carbohydrates. Some have medicinal properties too. The local people know better about their medicinal values as well as food processing. In Ayurveda many of the minor fruit crops have been used since ancient time. Those areas have the reservoir of genetic diversity and variability of these underutilized fruit crops. It is hardy in many ways like adverse climatic condition, insect and disease infestation. It needs to be exploitation of these fruit crops by our extension functionaries, scientists, farmers, governments, etc. It is also needs for study of their nutritive and medicinal properties by the recognized institutes. Some of the works have been done on those fruits crops but it needs more and more work on that. This may be the future and remunerative crop for that particular area as well as state. By those potential underutilized fruit crops the socio-economic condition of farmers will be enhanced.

Agroforestry: A Suitable option to increase farmer's income in Jabalpur region of Madhya Pradesh

Parul Sharga¹, Dr.S.D Upadhyaya², Dr.Nanita Berry³ Dr.D.V.Bhagat⁴.

1. Silviculture Tropical Forest Research Institute, Jabalpur, M.P.

2. Medicaps University, Indore, M.P.

3. 'E' Forest Protection Division, Tropical Forest research Institute, Jabalpur, M.P.

ABSTRACT

The tree species *Gmelina arborea* in current scenario is in great demand for multiproduct uses particularly for its timber quality. An experimental trial on *Gmelina arborea* based agroforestry system was carried out to study tree crop interaction. The study comprised of different tree-crop combinations. Arable crops selected were pigeon pea, cowpea, greengram, mustard. Various parameters were evaluated in order to evaluate the resource utilization as well as distribution among the components of the agroforestry system. The experimental trial of *Gmelina* was two and half years old. So, it was observed that in the early growth stages of tree species there occurred minimal competition at tree-crop interface. It was found that growth resources quantification particularly for light, productivity under agroforestry system did not suffered negative interactions. While, soil moisture content was quite affected leading to competitive phase. The light interception studies revealed that the tree canopy does not caused obstruction in growth of arable crop taken under experimental study. The nutrient contents in the soil under the agroforestry system got enhanced. So, it is recommended from the present study to all the stake holders involved in practices of agroforestry that maximum benefits can be withdrawn from the crop system at initial growth stages of tree species and after reaching the exploitable diameter, profits are withdrawn from woody perennials. Hence, the practice of agroforestry system is a long term project analysis giving rise to better utilization of land constraint and maximum resource sharing.

Keywords: *Gmelina arborea*, Agroforestry system, Tree crop interaction, Soil Moisture

Impact of Organic Nutrient Management on Yield and Economics of Green Gram (*Vigna radiata* L.)

Rahul^{1*}, Shikha Singh¹, M. R. Meshram¹ and Shivani Kumari²

¹Department of Agronomy, SHUATS, Prayagraj, India

²Department of Agronomy, SASRD, Nagaland University, Nagaland, India

ABSTRACT

An experiment was conducted during *zaid* season of 2021 at SHUATS Model Organic Farm, Department of Agronomy, SHUATS, Prayagraj (U.P). The experiment was laid out in Randomized block design and having nine treatment consisted of three 3 different manures farm yard manure, vermicompost, poultry manure and 3 different sources of spray panchgavya, vermiwash, fish amino acid which replicated thrice and effect was observed on Jawahar-1 greengram variety. The soil was sandy loam in texture, neutral in reaction (pH 7.0), low in available N (168.75 kg/ha), medium in available phosphorus (17.40 kg/ha), medium in available potassium (231.7 kg/ha) and low in available organic Carbon (0.38%). The result showed that growth parameters *viz.*, plant height (45.09 cm), branch/plant (5.73), plant dry matter accumulation (351.33g/m²) number of nodules (33.66/plant) and dry weight (14.05g/plant) yield attributes like effective seed/pod(13.10), pods/plant (35.45), test weight (37.08 g), seed yield (1433.33kg/ha), stover yield (3346kg/ha) were found to be significantly highest with T₅ i.e.,vermicompost @ 3t/ha + panchgavya 3%. Similarly highest gross return (INR 146679 /ha), net return (INR 100226 /ha) and benefit: cost ratio (2.16) were recorded higher with application T₅ i.e. vermicompost @ 3t/ha + panchgavya 3%.

Keywords: Green gram, Vermicompost, FYM, Poultry Manure, Panchgavya, Vermiwash, Fish Amino Acid

Impact of Nutrient Management on Yield and Economics of Pearl Millet (*Pennisetum Glaucum* L.)

Niteen Amarghade* and Rajesh Singh

Department of Agronomy, SHUATS, Prayagraj, India

ABSTRACT

A field experiment was conducted during *zaid* season 2021 at Crop Research Farm, Department of Agronomy, SHUATS, Prayagraj (UP) on sandy loam soil to investigate the impact of nutrient management on yield and

economics of Pearl millet (*Pennisetum Glaucum* L.). The experiment was laid out in Randomized Block Design with seven treatments each replicated thrice. It was consisted of combination of two levels of inorganic sources I₁ - (50% RDN), and I₂ - (75% RDN) and three levels of organic manure, O₁ - (50% FYM), O₂ - (50% Vermicompost), and O₃ - (50% Poultry manure). The treatment combinations are T₁: 50% RDN + 50% FYM, T₂: 50% RDN + 50% Vermicompost, T₃: 50% RDN + 50% Poultry manure, T₄: 75% RDN + 50% FYM, T₅: 75% RDN + 50% Vermicompost, T₆: 75% RDN + 50% Poultry manure, T₇: 100-40-40 kg NPK/ha. Report of study indicate that, among different nutrient levels the application of 75% RDN with 50% Poultry manure produced significantly superior plant height (165.67cm), plant dry weight (75.81 g), CGR (20.96 g/m²/day), RGR (0.45 g/g/day), length of ear head/plant (24.81 cm), test weight (8.39 g), grain yield (3.18 t/ha) and biological yield (9.56 t/ha). However gross return (79500.00 INR/ha), net return (45953.47 INR/ha) and B:C ratio (1.36) were recorded with the application of 75% RDN with 50% Poultry manure compared to all other treatments.

Keywords: Pearl millet, Recommended dose of nutrient, Poultry manure, Grain yield

Development of Climate Resilient Rice Varieties

Y.Suneetha

Plant Breeding, ANGRAU- Agricultural Research Station, Bapatla

ABSTRACT

Thirteen high yielding, fine grain rice varieties tolerant to BPH and blast, namely MTU 1061 (Indra), MTU 1075 (Pushyami), MTU 1172 (Ksheera), MTU 1190 (Varam), MTU 1262 (Maruteru Mahsuri), MTU 1224 (Maruteru Samba), MTU 1239 (Sravani), MTU Rice 1212, MTU Rice 1280, MTU Rice 1281 were developed and released by me along with other Scientists during 2007 to 2021 from Regional Agricultural Research Station, Maruteru and the varieties, BPT 2595 (Teja), BPT 2782 (Bhavathi) and BPT 2411 (Sasya) from Agricultural Research Station, Bapatla of Acharya N.G. Ranga Agricultural University, Andhra Pradesh for the benefit of rice farmers in the country. All varieties are of late duration type, except MTU 1075 and MTU Rice 1280, which are of medium duration. Further, seven rice varieties, namely, MTU 1075, MTU 1172, MTU 1190, MTU 1239, MTU Rice 1212, MTU Rice 1280 and MTU Rice 1281 have been released by the Central Variety Release committee and are being cultivated extensively in the states, namely, Orissa, West Bengal, Bihar, Chattisgarh, Jharkhand, Karnataka and Tamil Nadu. Six rice varieties, namely, MTU 1061, MTU 1262, MTU 1224, BPT 2595, BPT 2782 and BPT 2411 are being cultivated widely in the states of Andhra Pradesh and Telengana and to some extent in the neighbouring states. The rice varieties, MTU 1061, BPT 2782 and BPT 2411 are also salinity tolerant, while MTU 1172 and MTU 1190 are tolerant to submergence. Further, all the Maruteru rice varieties developed are also resistant to Bacterial leaf blight disease. The rice varieties, BPT 2411 and BPT 2782 are tolerant to anaerobic germination and hence, highly suitable for wet direct seeding. All the above mentioned rice varieties possess two weeks seed dormancy and are non-lodging with thick culm and are also non-shattering and hence, are climate resilient varieties, highly beneficial to the rice farmers. Therefore, these varieties are rapidly replacing the existing mega rice varieties, namely, BPT 5204 (Samba Mahsuri), MTU 7029 (Swarna), MTU 1001 (Vijetha) and MTU 1010 (Cotton Dora Sannalu) in the state, as well as the country, and benefitting the rice farmers immensely.

Keywords : Climate resilient, rice, yield, quality

Purification of ligninolytic enzymes from *Pleurotus* spp. and their evaluation in dye decolorization

Asha Singh Rajavat^{1,2}, Neeraj Shrivastava², V. Mageshwaran¹, Ritu Vishwakarma¹, Abha Agnihotri², Anil K. Saxena¹, K Pandiyan^{1,3*}

¹ICAR-National Bureau of Agriculturally Important Microorganisms, Mau

²Amity Institute of Microbial Technology, Amity University, Noida

³ICAR-Central Institute for Research on Cotton Technology (CIRCOT), Mumbai

ABSTRACT

The dyeing process discharges around 10 to 15 % of colors in effluents, posing health and environmental threats. White-rot fungi are robust candidates in removal of various dyes as they are capable of degrading and mineralizing variety of highly hazardous, recalcitrant and organic pollutant compounds. In this study, *Pleurotus* spp., white-rot fungi, were evaluated for its ligninolytic enzyme production potential using three agro-residues such as paddy straw, wheat straw and sugarcane bagasse under different incubation periods viz. 7, 14, 21 and 28 days. The results showed the maximum production of laccase (4596.89 ± 126.7 U ml mn⁻¹) and manganese peroxidase (1631.21 ± 54.1 U ml mn⁻¹) enzyme by *P. ostreatus* D-66 after 21 and 28 days, respectively from paddy straw. However, the highest lignin peroxidase activity (1082.32 U ml mn⁻¹) was observed from *P. Pulmonarius* D-79 after 21 days. The purification of laccase and manganese peroxidase from *P. ostreatus* D-66 showed 64.8- and 21.5-fold increase with yield of 54.0% and 17.9%, respectively. The lignin peroxidase purification from *P. Pulmonarius* D-79 resulted in 17.6-fold purification with a yield of 23.4%. Purified enzymes were stable at wide range of pH (pH 3.5 to 7.5) and temperature (30 to 50 °C). Decolorization potential of purified enzymes was evaluated using various synthetic dyes such as anthraquinone, azo, triphenylmethane and heterocyclic dyes. The highest decolorization efficiency (90.08%) was observed in purified laccase of *P. ostreatus* D-66 with Remazol brilliant blue R and *P. Pulmonarius* D-79 (78.81%) with methyl green. Paddy straw was found to be a potential substrate for maximum production of ligninolytic enzymes from *Pleurotus* spp. and their purified enzymes could be effectively used to decolorize the synthetic dyes in textile effluents and other biotechnological applications.

Keywords: *Pleurotus* spp.; ligninolytic enzymes; Agro-residues; Synthetic dyes; decolorization.

Preparation of high porous-carbon from Agricultural waste Mattaparthi Lakshmi Durga, Sandip Gangil and Vinod Kumar Bhargav

ABSTARCT

In agriculture, after harvesting the productive or commercial part from the crop, the unproductive part is normally leftover for uncontrolled fermentation or composting or burning in open fields. This burning of agricultural residues leads to the environment pollution. Hence, sustainable management of agricultural residues is needed. To convert the agro-residues into valuable product, such as high porous carbon, thermochemical conversion processes are used. High porous carbon has numerous applications like filtration, adsorption, catalyst, super-capacitor manufacturing and soil amendment, etc. Pyrolysis is common technique to produce carbonaceous solid biomaterial from crop residues. After pyrolysis, the activation can be done physically or thermally or chemically or combination these methods. Quality of the activated carbonaceous biomaterial depends on production process parameters. The researchers have stated that, pyrolysis and activation temperature had major effect on the surface area and porosity of generated carbon. Similarly, impregnation ratio (in chemical activation), residence time, activating agent and type of precursor material have impact on the surface area of porous carbon. The quality of the produced porous carbon is represented quantitatively by BET surface area (m² /g), pore volume (cm³ /g), adsorption levels; and analytically through SEM and FTIR scans. However, most commonly used adsorbency level is iodine number (mg/g) and methylene blue value (mg/g). These indices give understanding of micro-pore or meso-pore ranges over the adsorbent. Present review will discuss the use of different types of precursor materials to produce high porous carbon. Different methods of activated carbon production are critically discussed to describe how the process temperature will affect the pore area and volume, and thereby adsorption levels. This review paper concluded that

there is need of modelling between process parameters and adsorbency nature of activated carbon. Such correlations will help to get desired adsorbency qualities in activated carbon for specific application by finalizing the production process parameters.

Comparison of Residual Effect of Different Sources of Zinc in terms of Apparent Recovery Efficiency in Rice-Maize Cropping System

Aswathy. S. Nair *G. Padmaja

Department of Soil Science and Agricultural Chemistry, Professor Jayashankar Telangana State Agricultural University (PJ TSAU), Hyderabad

Professor Jayashankar Telangana State Agricultural University (PJ TSAU), Hyderabad

ABSTARCT

Agrofortification of crops with zinc is a strategic way of enhancing zinc content in crops. It is reported that large quantities of soil applied zinc to the crop is left unused, so the information of residual effect of zinc fertilizers after a period of application is desirable. Two year field experiment was undertaken with aim to compare residual effect of different sources of zinc that applied to first year crop, rice on the second year crop, maize in rice maize cropping system in terms of apparent recovery efficiency. A field experiment was carried out at college farm, College of Agriculture, Rajendranagar, PJ TSAU. The sources used in the study were zinc sulphate (21% Zn) and zinc oxide (80% Zn), biozinc (6% Zn) and nano ZnO (3% Zn). Among the different sources of zinc used in study, biozinc and nano ZnO were nanoformulations. The experiment was laid out in randomized block design with 16 treatments and 3 replications. The soil application treatments for maize were T₁ (control), T₂ (RDF @ N: P₂O₅: K₂O @ 120:60:40 kg ha⁻¹), T₃ (RDF + residual effect of ZnSO₄ @ 25 kg ha⁻¹), T₄ (RDF + residual effect of ZnSO₄ @ 50 kg ha⁻¹), T₅ (RDF + residual effect of ZnO @ 6.25 kg ha⁻¹), T₆ (RDF + residual effect of nano ZnO as impregnated granules @ 10kg ha⁻¹), T₇ (RDF + residual effect of nano ZnO as impregnated granules @ 15 kg ha⁻¹), T₈ (RDF + residual effect of nano ZnO as impregnated granules @ 20 kg ha⁻¹), T₉ (RDF+ residual effect of bio-Zn @ 12.5 kg ha⁻¹), T₁₀ (RDF+ residual effect of bio-Zn @ 25kg ha⁻¹) and T₁₁ (RDF+ residual effect of bio-Zn @ 50 kg ha⁻¹). Apparent recovery efficiency of zinc in maize was calculated adopting standard procedures and statistical calculation. Apparent nutrient efficiency was calculated in maize based on residual zinc left over in soil after harvest of rice, zinc content, uptake and yield of maize crop. The apparent nutrient efficiency of soil application treatments T₃, T₄, T₅, T₆, T₇, T₈, T₉, T₁₀ and T₁₁ were 7.00 %, 3.00 %, 5.00 %, 18.00 %, 32.00 %, 5.00 %, 31.00 %, 33.00 % and 15.00 % respectively. The result clearly showed that among the soil treatments, highest apparent recovery efficiency in maize as a residual effect was recorded with soil application of nanozinc @ 15 kg ha⁻¹ (32.00 %) (T₇) followed by biozinc @ 12.5 kg ha⁻¹ (31.00 %) (T₉). It also evident that residual apparent recovery efficiency reported with nano ZnO and bio zinc was significantly higher than conventional sources of zinc such as ZnSO₄ and ZnO. The high residual recovery of nanoformulations suggests its suitability in cropping system.

Key words: Apparent recovery efficiency, residual effect, nano ZnO, biozinc, ZnSO₄, ZnO

Biochemical profiling of safflower (*Carthamus tinctorius*) petals

Praduman Yadav¹, Shiva Shanker Kaki² and Mukta N¹

¹ ICAR-Indian Institute of Oilseeds Research, Hyderabad-500030, India. ² CSIR- Indian Institute of Chemical Technology, Hyderabad-500007, India.

ABSTARCT

Safflower, a multipurpose crop, has been grown for centuries in India for the orange-red dye (carthamin) extracted from its colored flowers and for its quality oil. The seed oil of this oilseed crop is enriched in linoleic acid is grown mainly in *Rabi* season under receding soil moisture conditions. Safflower petals are rich source of antioxidants due to presence of several bioactive compounds. Petal decoction is a popular drink due to presence of antioxidants and essential fatty acid. An experiment was carried out to evaluate the oil content and fatty acid profile of safflower petals. Safflower petals (20 g) were extracted using soxhlet extraction apparatus with hexane as solvent. The crude extract was analyzed by TLC and small amount of material was converted to fatty acid methyl esters using 2%

sulphuric acid in methanol reagent. The analysis of methyl esters was carried out using Gas Chromatograph Agilent 6890 series equipped with flame ionization detector. TLC analysis showed that safflower petal extract does not contain triglycerides. Palmitic (20.2%), oleic (11.1%), linoleic (10%) and linolenic (9.2 %) acids were the predominant fatty acids in the hexane extract. 26.7% of non-fatty acid components were present in the hexane extract. Based on GC-MS analysis, it was found that they were hydrocarbons. Results suggest that safflower petals do not contain oil. Petal extract is rich in essential fatty acid.

Comparative study on soaking and germination on the nutritive, anti-oxidant activity, and bioactive composition of Quinoa

Priyanka Thakur*, Krishan Kumar, Divya Chauhan, Qurat Ul Eain Hyder Rizvi, Sumaira Jan, Naseer Ahmed, and Tajendra Pal Singh

Department of Food Technology, Dr. Khem Singh Gill Akal College of Agriculture, Eternal University, Baru Sahib, Sirmour, HP- 173101#

ABSTARCT

Quinoa (*Chenopodium quinoa* Willd.) is an ancestral species from the Andean region, which is considered as a staple food for its populations. Quinoa evolves as a healthy substitute to gluten-rich grains for the preparation of gluten-free food products. Besides being gluten-free, they are also a rich source of protein, fiber, vitamins, and minerals. Soaking and germination are treated as simplest, cost-effective and the most commonly used techniques to improve the nutritional quality of food grains. For soaking treatment, seeds were soaked for 12 and 24 hours. Prior germination, seeds were soaked for 16 hours before being germinated for 24, 48, and 72 hours. The soaked and sprouted grain was dried at 40°C in a hot air oven. The prolonged soaking and germination time resulted in increasing the contents of crude protein, crude fiber, total phenolics content, and antioxidant activity significantly ($p \leq 0.05$) by 5.35, 18.53, 17.72 and 9.87%, respectively and 19.68, 52.88, 71.56, and 34.88% respectively. There was also significant ($p \leq 0.05$) decrease in crude fat, tannin content, and phytic content by 1.72, 14.58, and 5.83% and 19.41, 27.08, and 47.57% during soaking and germination respectively. Therefore, it can be concluded that in comparison of soaking and germination, germination was highly effective treatment for improving the nutritional, anti-oxidant activity, bioactive components and decrease the anti-nutritional components of quinoa.

Keywords: Quinoa, soaking, germination, nutritional, anti-oxidant activity, phenolic and anti-nutritional components.

The Santhal painting- Magic in hues" Vulnerable Art that needs attention

Shalini Pandey*

**Department of Fashion Design, Mandsaur University, M.P **

ABSTRACT

India has always attracted the whole world for its knowledge, cultural, tradition, art and craft. However, it's a sad reality that we have lost lots of crafts due to different reasons, and some of the arts need attention as they are at the edge of being extinct. "Santhal painting" is one of the few vulnerable arts that need to be persevered. They originated during the pre-Aryan period, the Santhal tribe is ancient but their paintings are interestingly contemporary in their human-figure design. The figures are dramatic yet realistic and symmetrical. It is rare to see such talent without formal training and in free hand painting. These paintings have simple themes like wedding, harvest, music and

daily rituals, but the colors and artistic imagination bring the most mundane alive. These tribal paintings are drawn by a special community called *Jadu Patua* or magic painters in the Santhal Paragana district of Bengal/Bihar borders. These paintings are exceptional but sadly they are becoming increasingly rare. These paintings originally had numerous genres which cannot be spotted now. *Chakshudana* is one such kind which was painted for the family of the recently deceased. It is for this genre that the painters got famed as *Jadupatua* or magic painters as they were believed to help the dead. Artisans today are not fetching the right price due to the lack of a platform for selling their paintings, so they are shifting towards other livelihood options. Needless to say, urgent actions are needed to safeguard this art on the brink of extinction. Santhal painters mainly remained entirely naïve as they hardly came under the influences of the Mughals, Rajputs or the British. Hence, their designs and style remained original and authentic. The painters use handmade paper which is sometimes backed by cloth-based canvas. Natural vegetable-based colors are used for paint as seen in the most tribal paintings.

Keywords: Vulnerable, Extinct, Persevered, Symmetrical, Mundane, Safeguard, Tribal

Effect of organic nutrient management on productivity, sustainability and economics of bushy type rajmash (*Phaseolus vulgaris L*) under sub alpine conditions of Bhadarwah
Rohit Sharma, Neeraj Kotwal, Manoj Kumar, Mahital Jamwal, Sanjeev Kumar, N. P. Thakur, Manpreet Kour Parshotam Kumar and Vishal Sharma

Regional Horticultural Research Sub-station, Bhadarwah

Sher-e-Kashmir University of Agricultural Sciences and Technology of Jammu

ABSTARCT

A field experiment was conducted at research farm of Regional Horticultural Research Sub-station Bhadarwah, Sher-e-Kashmir University of Agricultural Sciences and Technology of Jammu during *Kharif*, 2015 and 2016 on Rajmash (*Phaseolus vulgaris L*) to study the “Effect of organic nutrient management on productivity, sustainability and economics of bushy type rajmash (*Phaseolus vulgaris L*) under sub alpine conditions of Bhadarwah”. The experiment was laid out in Randomized Block Design consists of six different combinations of organic sources of nutrients including FYM, vermicompost, neem cake, rice straw and pine needles. The sight of the experiment was sandy clay loamy in texture, high in soil organic carbon content (0.81), medium in available nitrogen (310 kg/ha) and potassium (115kg/ha) and high in available phosphorous (35 kg/ha). Based on 2nd year of experimentation it has been observed that the maximum yield of rajmash was realized (15 q/ ha) with cost of cultivation of Rs. 85420/ ha, Gross return of Rs. 3000/ ha, Net return of Rs. 55420/ ha and B:C ratio of 0.65, respectively under T₄ treatment where 1.25 t/ ha FYM + 1.25 t/ ha vermicompost + 1.25 t/ ha neem cake + 1.25 t/ ha pine needles + biofertilizer + rock phosphate @ 56 kg/ ha was applied followed by T₆ treatment (1.25 t/ ha FYM + 1.25 t/ ha vermicompost + 1.25 t/ ha neem cake + 1.25 t/ ha pine needles and seed treatment through trichoderma (4g/kg of seed) + Neem oil (3%) through foliar spray after one month and repeated at 15 days interval resulted in rajmash yield of 14.7 q/ ha, cost of cultivation of Rs. 84860.00, Gross returns of Rs 29400.00, Net returns of Rs. 55460.00 and B:C ratio of 0.654 over rest of the organic combinations. Slight improvement in soil organic carbon content was observed over initial value of 0.81% and its range varied from 0.85 to 0.94% where organic combinations of nutrients was applied.

Key Words:- FYM, Vermicompost, Neem cake, Rice straw and Pine Needles.

Approaches for oil quality enhancement in Rapeseed (*Brassica campestris* L.)

VIVEK SINGH*, SHARAD PANDEY, GIDEON SYNREM*****

Department of Agriculture, Himgi Zee University, Dehradun (Uttarakhand)

ABSTRACT

Indian vegetable oil economy is the fourth largest in the world and Rapeseed- Mustard accounts for 13.2% of worlds edible oil supply and is the third most important edible oil, globally. Rapeseed-mustard, plays a significant role in the Indian economy by providing edible oils, vegetables, condiments and animal feed. India ranks third in rapeseed-mustard production and is the most important edible oilseeds crop, accounting for 30% of the total oilseeds production in the country. A good, health-friendly oil should be cholesterol- and trans-fat free, low in saturated fat and high in monounsaturated fat and polyunsaturated fat, and should have an ideal N6 to N3 acids ratio as well as a high smoking point. Rapeseed-Mustard oil meets all these criteria, and is considered good for health due to low presence of harmful saturated fatty acids. Rapeseed-Mustard oil is rich in monounsaturated fatty acids and polyunsaturated fatty acids, which is good for cardiovascular health. Consumption of this oil lowers blood pressure and lessens, body fat that increase the risk of cardiovascular disease. Oil content and oil quality fractions (viz., oleic, linoleic and linolenic acid) are strongly influenced by the erucic acid pathway in oilseed Brassicas. Low levels of erucic acid in seed oil increases oleic acid content to nutritionally desirable levels, but also increases the linoleic and linolenic acid fractions and reduces oil content. It contains about 60 per cent monounsaturated fatty acids (MUFA), 21 per cent polyunsaturated fats (PUFA) and about 12 per cent saturated fats. High levels of MUFA and PUFA is termed as good fats, helpful in maintaining good heart health and lower bad cholesterol, while improving good cholesterol. It also consists of six per cent of the omega-3 fatty acids (N-3) and 15 per cent of the omega-6 (n-6), the two essential fatty acids in the ideal ratio of 1:2, which is a huge benefit for the heart, as it balances cholesterol levels. This, in turn, reduces triglycerides or blood fat levels, and helps in keeping the heart healthy. Increasing oil content in rapeseed mustard is a major breeding objective-more so, in the lines that have "0" erucic acid content (< 2% of the seed oil) as earlier studies have shown negative pleiotropic effect of erucic acid loci on the oil content. Approaches such as molecular breeding, Hybrid breeding, Anther culture, Somaclonal Variation, Protoplast Culture, Transgenic Plants, Genomics and Omics approaches, Proteomics and Metabolomics for oil quality enhancement are gaining much importance for improving health of humans.

Key words : Brassica, Oil content, Fatty acids, Transgenic.

Physio-chemical analysis of quality, evaluation and development of Bottle gourd lemon mint squash

^{1*}Ashish Kumar, ¹Aplana

Department of Agriculture and Food business, Amity University, Noida sec-125

ABSTRACT

Bottle guard lemon mint Squash is an innovative & unique idea to use all the three ingredients in the combination as all three contains fibres in it. Bottle gourd is tasteless and due to this reason less people consume it. It is alternative form for individuals to consume bottle gourd. Bottle gourd is an important vegetable of summer as well as rainy season. It is good source of nutrients, vitamins and fibres. Bottle gourd contains 96% water in it and it is good for digestion. Lemon is rich in vitamin C, citric acid as well as possessing anti-bacterial properties. The anionic food, lemon, is the sole anionic food in the world. This makes it good for health as it provides all cell energy by interaction between the anions and cations. Mint is rainy as well as winter season herb. It is source of vitamins, fibre and minerals. It refreshes our mouth and has a variety of medical benefits.

This Experiment was conducted in the Agricultural laboratory of Amity Institute of Organic Agriculture during the year 2018. Different combinations of bottle gourd, lemon & mint are prepared in laboratory. 8 samples are prepared with different concentrations of all three ingredient. 8 blends of bottle gourd, lemon & mint were taken in then ratio R₀- 100:0:0, R₁- 90:10:0, R₂- 80:17.5:2.5, R₃- 80:15:5, R₄- 70:27.5:2.5, R₅- 70:25:5, R₆- 60:37.5:2.5, R₇- 60:35:5

3rd International Conference on “Global Initiative in Agricultural, Forestry and Applied Sciences for Food Security, Environmental Safety and Sustainable Development (GIAFAS-2021)”

with R5 being the best in terms of sensory acceptability. It possessed good amount of total soluble solids and acceptable amount of sugar. The blended juice has vitamin C (4.67 mg/ml) TSS (10 °brix) and Acidity (3.9%). Squash was found palatable and good flavour. Due to its nutritional and functional features, squash is helpful to one's health and can be used to treat a variety of disorders.

Keywords- Bottle gourd, Lemon, Mint, TSS, Acidity, Squash.

**NEW RECORD OF SPIRALLING WHITEFLY, *ALEURODICUS DISPERSUS*, RUSSEL (HOMOPTERA: ALEYRODIDAE) IN BRINJAL FROM MANIPUR
SUSHMITA THOKCHOM**

Department of Entomology, Assam Agricultural University, Jorhat, 785013, Assam

ABSTRACT

The spiraling whitefly, *Aleurodicus dispersus* Russel was found infecting brinjal in Imphal, Manipur during October 2020 and January 2021. The life stages of *A. dispersus* were completed on leaves. The spiraling nature was also found and observed to be number of spirals. The heavily infested leaves were found crinkled and dry due to its attack. The honeydew and black sooty molds symptoms were also observed. Moderate infestation was found during rainy season but heavy infestation was observed from November to December, 2020. The bio pesticide, *Verticillium lecanii* was used and it was found to be effective and can prevent the population buildup of *A. dispersus*. The number of spirals and its population was found to be reduced within 7 days of application of the *V. lecanii*.

Key words: *Aleurodicus dispersus*, *Verticillium lecanii*, whitefly, brinjal, spiral, biopesticides

Post-harvest management for improving shelf life of banana fruit

Abhay Mankar¹, K. Karuna^{2*} and Ruby Rani²

¹*Directorate of Extension Education, B. A. U., Sabour, Bhagalpur, Bihar, India*

²*Department of Horticulture (Fruit & Fruit Tech.) B. A. U., Sabour, Bhagalpur, Bihar, India*

ABSTRACT

Banana fruits are liked by the people worldwide because of its multipurpose uses like table purpose, vegetables, beverages, chips, figs, floor, etc. Banana is although a tropical fruit crop but it can be successfully cultivated in subtropical regions. Due to lack of sufficient processing industry, ripening chamber, pre cooling chamber, congenial transportation facility, etc. in India, the post-harvest losses are much higher all over the country. Non availability of above facility to the growing area of banana, it may lack behind in international markets and may cause economic loss to the growers. Lots of work has been done on post-harvest management of banana but growers are not much benefitted. It might be due to lack of training, or extension of technology from lab to farmer's field. Even though ripening is also one of the important components for best quality banana fruits which will be fetch better price in national and international market. For this purpose, ripening chamber is essential for uniform ripening, firmness of pulp, attractive yellow colour fruits and better quality. Packaging of fruits in different cushioning materials is also beneficial for increasing shelf life of fruits. Different chemicals like calcium chloride or calcium sulphate enhance or retain the fruit firmness which is used by the progressive farmers. It needs to be exploring through extension to other farmers also for better return. Processing industry in the banana growing region may be beneficial to reduce glut in the market. Raw materials may be easily available to the industry.

Analysis of soil samples for different physico-chemical properties in middle IGP of Bihar

Basant Kumar Sharma¹ and M. Shamsul Islam²

¹*P.G. Department of Biotechnology, Magadh University, Bodhgaya, Bihar (India) -824234*

²*Daudnagar College, Daudnagar, Aurangabad, Bihar (India)-824113*

ABSTRACT

In the present endeavour, an attempt has been made to assess the soil status of the farmers' field. 153 soil samples were collected from the field of 32 farmers during 2015-16 in Kishanganj, Katihar and Purnea districts of Bihar representing the Middle Indo-Gangetic Plains of India. The samples were analysed for different physico-chemical

3rd International Conference on “Global Initiative in Agricultural, Forestry and Applied Sciences for Food Security, Environmental Safety and Sustainable Development (GIAFAS-2021)”

parameters as pH , EC (ds/m), OC(%), N (kg/ha), P (kg/ha) and K (kg/ha). Soil analysis revealed that the soils of Katihar districts were slightly acidic to normal in reaction (pH 5.5-7.6), Purnia; acidic to near normal (pH 4.4-6.5) and Kishanganj; acidic (pH 4.18-4.37). However, the organic carbon content in Kishanganj soils was higher (0.50-0.70) as compared to Purnea (0.30-0.50) and Katihar (0.26-0.48) soils. Nitrogen content was in medium range in all the districts, where as the phosphorus content in katihar and Kishanganj soils were medium (15.27 to 18.28 kg/ha), but it was high in Purnea district (28.96 kg P/ha). The potassium content was medium in all the soils of all three districts and varied from 161 kg/ha in Kishanganj to 219 kg/ha in Katihar.

Key words : Soil samples, Organic carbon, Phosphorus, Nitrogen, Potassium, Soil nutrients.

Forest Fire Management: A review

Ranjeet Kumar, Richa Sharma, Krishna Kumari and Sangeeta Verma

Himalayan Forest Research Institute, Panthaghati, Shimla, H.P., India-171013

ABSTRACT

Forest fire is considered as a good servant and an evil master. The main cause of the forest fire is anthropogenic in nature. The climatic variability and global warming have also triggered the events of forest fires in recent years. Every year millions of hectares of the world forests is damaged by forest fire. The ground fire, surface fire and crown fire are three types of forest fire found in the forests.

As per Forest Survey of India data on the website, 37059 fire incidences were detected during 2018 by using MODIS (Moderate Resolution Imaging Spectro- Radiometer) sensor data. As per FSI technical information series of 2020 the area of 11,094 km² (1.56%) was affected by forest fires.

The forest fire may cause ecological and economic damage in the forests. Forest fires affect the density and diversity of plants, soil properties and ecosystem services. Forest fire also affect the natural generation of woody species and structure of forests. Forest fires are also responsible for increasing the invasion of invasive alien plant species, soil erosion, fragmentation of habitats and wildlife losses, etc. Sometimes it has also caused the loss of life of human beings.

Forest fires can be reduced by conducting control burning in winter when the temperature is low. The fuel load on the fire prone areas like accumulation of litter, ground organic matter, standing dead trees, grasses and herbaceous plants and cones of pines can be managed to control fire. Sound communication network and strong people participation can be effective mean to manage forest fires. Forest fire can also be prevented by creating awareness among people in the fringe villages of forests by conducting awareness programme on biodiversity conservation and training on prevention and management of forest fires. There is need to improve scientific knowledge on management practices of forest fire.

Keywords: Forest fire, causes, management, plant diversity and natural regeneration.

Effect of Cutting Length and Cutting Diameter on Macropropagation of *Melia composita*

¹Sakeena Gul Niazi*, ²Dinesh Kumar and Ashok Kumar

^{1,2} Silviculture G and Forest Management Division, Forest Research Institute, Dehradun.

³ Genetics and Tree Propagation Division, Forest Research Institute, Dehradun.

ABSTRACT

Melia composita Willd. belongs to family Meliaceae, a multipurpose, deciduous, fast growing tree indigenous to India, Southeast Asia and Australia. The tree provides high-quality termite and fungus resistant timber for plywood

and pulpwood industries. The species is reported to have hard stony seed coat which makes it difficult to germinate without any treatment under the open condition. Vegetative propagation through cuttings are a simple and comparatively less expensive method for clonal multiplication of genetically superior trees. It provides for maximum benefits in terms of wood properties and productivity, as well as production of more uniform raw material for industrial uses. Rooting of cutting is generally influenced by length and diameter of the planted cuttings. Hence, the experiment was performed to assess the suitable size of cutting for the vegetative propagation of *Melia composita*. Collection of the material for cutting preparation was done from trees of superior genotypes at Dehradun during spring season. Shoot cuttings and root cuttings of 4 lengths viz. <5 cm, 5-7.5 cm, 7.5-10 cm, >10 cm and 4 diameter classes viz. <5 mm, 5-7.5 mm, 7.5-10 mm, >10 mm were prepared. The shoot cuttings were planted in Randomised Block Design after treatment with 2000 ppm IBA whereas root cutting was planted without IBA treatment. The highest survival percentage in shoot cuttings were observed in cutting of length more than 10 cm and diameter more than 10 mm.

Keywords: *Melia composita*, Vegetative propagation, Clonal, Shoot cuttings, Root cuttings.

HEAT INDUCED DECREASED ACTIVITY OF NITRATE REDUCTASE AND ITS IMPACT ON YIELD UNDER LATE SOWN CONDITION IN THREE GENOTYPE OF WHEAT (TRITICUM AESTIVUM L).

Kamla Jakhmola*, Sobha, Shweta Sahni

School of Agricultural Sciences, Shri Guru Ram Rai University, Patel Nagar (Dehradun), 248001 Uttarakhand

ABSTRACT

Wheat is an important crop of the tropics, being a rabi crop it is adapted to low temperature (18-25), as global temperature is increasing day by day, it seems to be a major problem to the wheat growing area of India and other countries, because wheat is susceptible to terminal heat tolerance. So heat tolerance study is become very important to maintain wheat productivity to feed the coming population. Present investigation is carried out to study the genetic variability in wheat to heat tolerance and impact of increasing temperature on activity of nitrate reductase enzyme which is an important enzyme of nitrogen metabolism. In the present study variability in nitrate reductase activity, was found amongst the genotypes viz. Lok54, Raj 3765 and HI1544 shown high nitrate reductase enzyme in heat stress, and NR activity is found to be increased in timely sown condition and low at late sown condition. But some tolerant genotype like Lok 54, Raj3765, HI1544 sown high activity as compare to susceptible one. Genotype with high NR activity also sown low heat susceptibility index and high yield in late sown condition. This finding suggests that wheat genotypes are found to differ in their ability to respond to heat, there by tolerance, which could be useful as genetic stock to develop wheat tolerant varieties in breeding programs.

Key Words- Heat Susceptibility Index, Nitrate Reductase, Susceptible, Tolerant

Chromatographic and spectroscopic analysis of heartwood extract of *Pterocarpus* species

Kamal Mishra¹, S. S. Bisht¹, K. K. Pandey¹, Girish Chandra²

¹Institute of Wood Science and Technology, 18th Cross Malleshwaram, Bangalore - 560003, India

²Division of Forestry Statistics, Indian Council of Forestry Research and Education, Dehradun - 248006, India

ABSTRACT

In this study, chromatographic (TLC and HPLC) and UV-Vis spectroscopic analysis of methanolic extract of *Pterocarpus santalinus* Linn (Red Sanders) heartwood, collected from trees growing in eight different locations was carried out. Usefulness of these techniques for discrimination of some of the commonly occurring species in *Pterocarpus* genus was assessed. TLC fingerprints of methanolic extract of *P. santalinus* revealed distinct spots at R_f 0.94 (light brown), 0.91 (purple), 0.79 (blackish brown), 0.75 (light purple), 0.60 (yellow), 0.51 (dark red) and 0.28 (brownish red) in normal phase. HPLC analysis indicated at least 11 common peaks at retention time (tR) 3.1, 3.5, 8.9, 11.1, 12.8, 13.5, 14.9, 15.7, 17.9, 18.3 and 26.5 (minutes). Heartwood extractive in methanol exhibited a broad UV visible absorption spectrum with consistency in major absorbance peaks at ~280 nm, ~320nm, ~472 nm and ~505 nm. Similarities in chromatographic pattern between the samples from different locations were evaluated using

3rd International Conference on “Global Initiative in Agricultural, Forestry and Applied Sciences for Food Security, Environmental Safety and Sustainable Development (GIAFAS-2021)”

the principal component analysis (PCA). Finally, developed fingerprints of methanolic extract of *P. santalinus* heartwood were compared with those of *Pterocarpus marsupium*, *Pterocarpus soyauxii*, and *Pterocarpus macrocarpus* heartwood extracts. The developed HPLC and TLC fingerprints of *P. santalinus* shows different signature as compared to other *Pterocarpus* species. These developed fingerprints may serve as supplementing tools for identification and evaluation of heartwood of *P. santalinus*.

Keywords: Heartwood, HPLC, *Pterocarpus santalinus* Linn, TLC, UV-Vis spectroscopy.

EFFECT OF DIFFERENT CONCENTRATIONS OF KINETIN ON *IN VITRO* SHOOT MULTIPLICATION OF BAMBOO

Chavan N. S., Chavan N. R., and Kale Sonam S.

Department of Plant Biotechnology, Mahatma Gandhi Mission College of Agricultural Biotechnology, Aurangabad, 431003 MS. INDIA.

ABSTARCT

The shoot multiplication was obtained for nodal explant of *Bambusa balcooa*. The field grown healthy and disease free bamboo plant was selected from fields. The nodal explants were collected from this mother plant. The explants were cut in suitable size up to 5 cm with node in middle before sterilization. The explant width was 0.5cm. After thoroughly washing with running tap water for 30 minutes and explants explant were subjected to surface sterilization in 1% bavistin for 15 minutes then 1 % tween twenty detergents for 15 minutes followed by 30 seconds wash of 70 % ethanol. Before inoculation 4 washes of sterile double distilled water was given. This experiment was laid down in completely randomized design with 10 treatments (0 to 9 mg/l) of growth hormone kinetin in Murashige and Skoog Media. The explant were inoculated in different kinetin containing media bottles and incubated at 25 degree celcius, 16 hours light and 8 hour dark condition with humidity of 55 %. The inoculated explants were observed for shoot initiation, shoot number, shoot length and number of leaves. It was concluded that treatment T₆, T₇, T₈, T₉ with concentration of 6 mg/l, 7 mg/l, 8 mg/l, and 9 mg/l kinetin in MS media was found best among all other treatment for multiple shoot induction. The experiment was laid out in completely randomized design with 10 treatment of growth hormone kinetin in Murashige and Skoog Media. There were three replications. The sterilization protocol used bavistin, tween twenty and ethanol as disinfectant. These chemical founds suitable for sterilization. Experiment was carried out by inoculating shoot node of bamboo with different concentrations of kinetin (0.0, 1.0, 2.0, 3.0, 4.0, 5.0, 6.0, 7.0, 8.0 and 9.0 mg/L). Shoot node of Bamboo plants were used as a explants in this experiment and inoculate in media containing hormones and incubated for 21 days for multiplication. The inoculated explants were observed for shoot initiation, shoot number, shoot length and number of leaves. It was concluded that treatment T₆, T₇, T₈, T₉ with concentration of 6mg/l, 7mg/l, 8mg/l, and 9mg/l respectively gives the best result among all other treatments.

ASSOCIATION MAPPING FOR DIFFERENT PHENOTYPIC TRAITS USING ELITE SORGHUM [*Sorghum bicolor* (L.)] GERMPLASM LINES

Chavan N. R., Kale Sonam S., Chavan N. S. and Sonwane V. R.

Department of Plant Biotechnolog, Mahatma Gandhi Mission College of Agricultural Biotechnology, Aurangabad, 431003 MS. INDIA.

ABSTRACT

Association Mapping involves searching for genotype-phenotype correlations among unrelated individuals. Its high resolution is accounted for by the historical recombination accumulated in natural populations. In this study, to

identify the marker-trait associations, the phenotyping and genotyping of 20 sorghum accessions was carried out under field and wet lab conditions to generate the data for analysis. The six different phenotypic traits were recorded. Their after the total genomic DNA was extracted from all 20 accession, quantify, diluted to 50ng/ul and used for PCR amplification using eight SSRs. The amplicons were resolved on the 3.5% agarose gel for better resolution and separation. The genotypic data was generated and the associations between marker and traits were identified using t-test in Microsoft excel programme. The analysis revealed that out of eight SSR markers studied, three markers Xtxp278, mSbCIR248, and Xtxp057 were found to be linked markers with two recorded phenotypic traits. Association between Xtxp057 on chromosome #06 and seedling length, this time the result is statistically significant because the p- value is well below 0.05. The p-value obtained after analysis was 4.22E-07 with percent of total phenotypic variation for a trait that is accounted by the marker (R^2) was 27.23 % for Xtxp057. Association of Xtxp278 marker on chromosome #08 with seedling length trait, the output obtained for this marker in this study was show association having p-value 4.22E-07 with R^2 value was 27.23% for 250bp band. The marker MSbCIR248 present on chromosome #05 show significant association/ linkage with plant height (PHT) using single marker analysis (SMA) by t-test. The p-value obtained was 0.034252 for trait plant height on 100bp molecular weight bands.

ISOLATION, CHARACTERIZATION AND GENETIC DIVERSITY ANALYSIS OF *TRICHODERMA* ISOLATES ISOLATED FROM GANDHELI, AURANGABAD REGION

Kale Sonam S., Chavan N. S., Chavan N. R., and Tapse S.

Department of Plant Biotechnolog, Mahatma Gandhi Mission College of Agricultural Biotechnology, Aurangabad, 431003 MS. INDIA.

ABSTARCT

Trichoderma Species are endophytic plant symbionts that are widely used as seed treatments to control biotic/ abiotic stress and to enhance plant growth and yield. In the present investigation five isolates of *Trichoderma* were isolated from gandheli, Aurangabad region. The total 50 soil samples from 14 different ecological habitats were collected in order to isolate *Trichoderma*. Five different *Trichoderma* isolates were isolated from soil sample and DNA was extracted by using CTAB protocol. Pure cultures were obtained from each isolate. Microscopic characterization of five *Trichoderma* isolates shows the clear conidia and phillids give the confirmation of *Trichoderma* isolates. The colony color varied from snow white to white, light green, green, to dark green. Genetic diversity based on morphological methods has been diminished due to the use of molecular techniques which have made advances in systematic characterization of *Trichoderma* spp. We studied genetic diversity in five isolates using RAPD markers. Amongst the five isolates tested, the isolate T2, T4 and T5 were grouped in one where as T1 and T3 were differentiate from each other and rest of the isolates. The polymorphism information content (PIC), a measure of gene diversity, varied from 0.26 to 0.56 with an average of 0.44 and was significantly correlated with number of alleles. Gene diversity computed according to Nei (1973) and varied from 0.32 to 0.64 with an average of 0.52. The major allele frequency across five isolates was ranged from 0.40 to 0.60 with the mean major allele frequency was 0.51.

Development of synbiotic lassi by using buffalo milk

S. G. Jagadale, Y. N. Patil, S. S. Ramod, V. B. Kadav and V. S. Dandekar

Department of Animal Husbandry and Dairy Science, , DBSKKV, College of Agriculture, Dapoli. Dist- Ratnagiri (MS) 415 712

ABSTRACT

Present study was carried out for developed synbiotic lassi from buffalo milk. Maltodextrin was added @ 1, 1.5, 2% as prebiotic and *Lactobacillus acidophilus* culture was used @ 1.5% in all treatments as probiotic. The results of present study, it may be concluded that maltodextrin could be successfully utilized for manufacture of synbiotic lassi. The most acceptable quality of synbiotic lassi was developed by using 1.5 per cent maltodextrin which contained on an average 22.33, 5.04, 3.16, 13.63, 0.62 and 0.75 per cent total solids, fat, protein, total sugar, ash and titratable acidity, respectively. The production cost of most acceptable synbiotic lassi (T₂) was Rs.55.98/- per lit. On the basis of sensory evaluation for most acceptable level, it is found that product was acceptable up to 8th day under refrigerated condition at 5 to 7 °C temperature.

Key words: - Lassi, synbiotic, maltodextrin.

Preparation of milk shake by using jaggery and Date (*Phoenix dactylifera* L.)

S. V. Surve, N. T. Chorage, Y. N. Patil, A. J. Mayekar and V. S. Dandekar

Department of Animal Husbandry and Dairy Science, DBSKKV, College of Agriculture, Dapoli. Dist- Ratnagiri (MS) 415 712

ABSTRACT

In the present study the milk shake was prepared from buffalo milk by incorporation of date pulp and jaggery at different levels viz. 5, 10 and 15 per cent date pulp and 4, 5 and 6 per cent jaggery in different combinations. From the result of present study, it may be concluded that date pulp and jaggery could be successfully utilized for preparation of milk shake. The most acceptable quality milk shake can be prepared by using 4 per cent jaggery and 10 per cent date pulp (J₁D₂). The most acceptable quality milk shake (J₁D₂) contained on an average, 25.57 per cent total solids, 6.02 per cent fat, 3.95 per cent protein, 0.881 per cent ash, 14.92 per cent total sugar and 0.163 per cent titratable acidity. The production cost of most acceptable milk shake (J₁D₂) was ₹ 105.08 per kg.

Key words: - Milk shake, jaggery, date, total solids.

Detection and Isolation of Seed Mycoflora of Lablab bean, Horse gram and Cowpea

Y K Nirgude, R R Rathod, U R Phondekar, R R Kalaskar and U V Mahadkar

Department of Plant Pathology, College of Agriculture, DBSKKV, Dapoli

ABSTRACT

Seed is primary most important input in Agriculture. Healthy seeds produce healthy crops and good yields. Most of the plants grown by seeds. Seed is a important source for producing optimum yield. Seed-borne pathogens may cause losses by deterioration, reducing seed germination, developing seed-borne diseases and seedling mortality at nursery stage. However, knowledge of the about the biology and extent of seed-borne pathogens can help to reduce seed and seedling losses.

All of the three seed health testing methods attempted viz., Blotter paper method, Agar plate method and PDA method were found effective to isolate and detect the seed mycoflora of lablab bean, Horse gram and Cowpea. The per cent frequency of association was found maximum in seeds of lablab bean with *Alternaria* spp. followed by

3rd International Conference on “Global Initiative in Agricultural, Forestry and Applied Sciences for Food Security, Environmental Safety and Sustainable Development (GIAFAS-2021)”

Fusarium spp. *Aspergillus* spp. *Trichoderma* spp. and *Rhizopus* spp. In seeds of horsegram the per cent frequency of association was found maximum in respect to *Alternaria* spp. and with the seeds of cowpea was found maximum in respect to *Alternaria* spp. followed by *Fusarium* spp. *Rhizopus* spp.

Keywords: Seed, Detection, Isolation, Cowpea, Lablab bean, Horse gram, Blotter paper method, Agar plate method, PDA method, *Alternaria*, *Aspergillus*, *Fusarium*, *Rhizopus*, *Trichoderma*.

GIS Based Decision Support Systems in Agriculture

Mahipal Singh Choudhary

Department of Agronomy, Rajasthan College of Agriculture, Maharana Pratap University of Agriculture and Technology, Udaipur

ABSTRACT

Crop identification and mapping is the need of the hour in today's world. Maps of crop are created by national and international agricultural agencies, and regional agricultural boards to prepare a record of what was grown in certain areas and system will be able to identify age of the crop. The most important activities include identifying the crop types and depict their extent (often measured in acres).

The efficiency and accuracy of data are improved when remote sensing data products and GIS are used. Precision farming, a combination of GIS, GPS receivers, continuous yield sensors, geostatistics and variable rate applicators is an innovative approach to practice of sustainable agriculture. We have tried to study use of GIS (Geography Information System) in agriculture. We also are going to classify the remotely sensed image via satellite and digitize the image. And this digitized image is going to be used to train the existing system so that it can automatically sense the image in future. The main technologies to implement this system are described in detail.

Key Words: GIS, agriculture, satellite image

Molecular Genetic Analysis for YMV Resistance in Blackgram(*Vigna mungo* L. Hepper)

K. R. SARAVANAN*, P. KARTHIKEYAN, S. VENNILA³, and S. SUGANTHI⁴

Department of Genetics and Plant Breeding

Faculty of Agriculture, Annamalai University, Chidambaram,

ABSTRACT

The present investigation on Molecular Genetic Analysis for YMV Resistance in Blackgram was carried out with five families namely P₁'s, P₂'s, F₁'s, F₂'s, F₃'s were performed with the following cross combinations KKM 1×VBN6, KKM 1 × VBN 8, ADT 5 × VBN 6, ADT 5 × VBN 8 was analysed for generation mean and single marker analysis. The result indicated the importance of dominance, dominance × dominance gene interaction in the expression of all the ten traits of interest in the entire cross combinations. It is suggested to postpone the selection to later segregating generations. Seventy progenies of the F₂ of ADT 5 x VBN 8 and two markers were subjected to simple regression approach. The SSR primer CEDG 180 was linked with percentage of disease infection had significant regression coefficient. The marker which is having a strongest relationship can be judged from its adjusted R² value which will give the overall percentage of variability of that particular trait explainable by marker. This marker as mapped in the F₂ population of 168 individuals at a map distance of 12.9 cM. The validation of this marker in ten MYMV disease resistant and seven MYMV disease susceptible genotypes has suggested its use in MAB for developing MYMV resistant genotypes in blackgram.

Keywords: Molecular validation, Single marker analysis, SSR markers.

COMPATIBILITY OF ESSENTIAL OILS WITH ENTOMOPATHOGENIC FUNGI; A POTENTIAL TOOL FOR INSECT-PEST MANAGEMENT

Renu Pandey*¹ and Sapna Tiwari²

Department of Entomology, G.B. Pant University of Agriculture and Technology, Pantnagar (263145)*¹

Department of Entomology, G.B. Pant University of Agriculture and Technology, Pantnagar (263145)²

ABSTRACT

Entomopathogenic fungi (EPF) are used as an alternative to conventional chemical insecticides to manage several insect-pests of agricultural crops. EPF, *Beauveria bassiana* (Balsamo) Vuillemin, and *Metarhizium anisopliae* (Metschnikoff) are important bio-control tools for the use in bio-intensive pest management strategies, owing to their broad host range and relative ease of manipulation. One of the ways to increase the effectiveness of these EPF is by combining them with essential oils and moreover conidial survival can be affected by interaction with agrochemical, environmental factor and or by biopesticides and/or chemical product used to protect plants. Therefore, in vitro compatibility of 6 essential oils (pamarosa, geranium, *pacholi*, eucalyptus, lemon and citronella) with entomopathogenic fungi (*Beauveria bassiana*, *Metarhizium anisopliae*) was tested. Disc diffusion assay method was followed to test the compatibility of essential oils with *B. bassiana* and *M. anisopliae*. Among six oils tested maximum inhibition zone was formed by lemon, (4.53 and 4.83 cm) followed by citronella (4.17 & 4.00), Pamarosa (3.00 & 3.67) & Geranium (1.83 & 3.67 cm) in *B. bassiana* and *M. anisopliae* respectively. Eucalyptus essential oil was the least inhibitory of all tested oils. A Minimum inhibition zone was observed in eucalyptus essential oil (0.77 & 1.30 cm). Whereas *patchouli* oil was found compatible with both the fungi as no inhibition zone was formed. From the study, it was evident that *M. anisopliae* was most susceptible to the essential oils as compared to *B. bassiana*. It was concluded that among all tested essential oils, *patchouli* oil have the potential to be used in combination with *B. bassiana* as well as *M. anisopliae* as biological control agents.

Key words: *Entomopathogenic fungi, essential oils, Disc diffusion assay, Inhibition Zone*

Breeding for disease resistance in Bamabara groundnut

Chitti Bharatkumar, Nandini R, Shweta A Mannikeri, Kailash Chandra, Umesh Naik and Pranesh

University of Agricultural Sciences, Dharwad

ABSTRACT

Bambara groundnut (*Vigna subterranea* L. (Verdc.) termed as a potential crop of future. It is considered to be a completely balanced Food with high protein (25-28%) and quantitatively superior to other pulses due to essential amino acids methionine and lysine.

Plant viral diseases inflict serious economic losses in major crops by reducing yield and compromising quality. Among several viral diseases of pulse crops, yellow mosaic virus causes major loss in the yield of the crop. The disease is characterized by faint yellow discoloration of young leaves and bright yellowing of older leaves on Bambara groundnut. Use of disease resistant crop varieties is regarded as an economical and durable method of controlling viral diseases.

The present investigation was planned to genetically improve the crop using induced mutation. The seeds were treated with Ethyl Methane Sulphonate concentrations ranging from 0.1 to 0.5 per cent. The M₂ populations of SB-42 were screened for yellow mosaic virus at K-block, University of Agricultural Sciences, Bengaluru, during summer 2014 under natural endemic field condition.

3rd International Conference on “Global Initiative in Agricultural, Forestry and Applied Sciences for Food Security, Environmental Safety and Sustainable Development (GIAFAS-2021)”

From Chi-square test 478 plants as moderately tolerant, 1432 plants as susceptible in the mutants of SB-42 a good fit of 3: 1 (Susceptible: Tolerant) ratio was observed. This suggests that single recessive gene controls tolerance to yellow mosaic virus disease in Bambara groundnut.

Effect of Foliar Application of Borex Levels on Growth, Yield and Quality of pomegranate (*Punica Granatum L.*)

Om Prakash Jitarwa¹, Satpal Baloda², Keshar Mal Choudhary³ and sushil⁴

¹Department of Horticulture , CCSHAU, Hisar, Haryana, India

² Department of Horticulture , CCSHAU, Hisar, Haryana, India

³ Department of Agronomy, SKNAU, Jobner , Jaipur , Rajasthan, India

⁴ ,Department of soil science , CCSHAU, Hisar, Haryana, India

ABSTRACT

A field experiment on “Effect of foliar application of borex Levels on Growth, Yield and Quality of pomegranate (*punica granatum L.*)” was conducted at Horticulture Farm, college of agriculture CCS-HAU Hisar during 2018-19 on loamy sand soil. The experiment consisting of four levels of borex (0, 0.2, 0.4 and 0.6 %/). The total 4 treatment combinations were tested in randomized block design with three replications. The Pomegranate variety Ganesh was seven year old plant at 5 x 5m spacing.

Results revealed that the Foliar application of borex @ 0.4% significantly increased the plant height (m), leaf area (cm), tree spread (m), fruit set %, number of fruits per plant, fruit density, fruit yield, average fruit weight (gm) , , fruit length(cm), fruit diameter(cm), total sugar, reducing sugar, non reducing sugar, TSS , aril%, juice% ,specific gravity, reduced peel % , fruit cracking % as compared to preceding levels. but statistically at par with 0.6 % . On the basis of experiment results, it may be concluded that foliar application of 0.4% was found significantly better for pomegranate crop in terms of growth yield and quality for farmers of semi arid zone of Haryana.

Keywords: borex, pomegranate, significantly

Impact of different sources of fertilizers on yield and quality parameters of Kinnow mandarin

Monika Yadav, G.S. Rana, R.P.S Dalal, Vijay, Sonu Kumari

Department of Horticulture, College of Agriculture

CCS Haryana Agricultural University, Hisar

ABSTRACT

Integrated nutrient supply management (INM) aims at maintenance or adjustment of soil fertility and of plant nutrient supply to an optimum level for sustaining the desired crop productivity through optimization of benefit from all possible sources of plant nutrients in an integrated manner. Therefore, keeping in view the nutritional requirements, the present study was undertaken to find out the most suitable fertilizer combination and their effect on yield and quality of Kinnow mandarin. The study was carried out at Department of Horticulture, CCSHAU, Hisar in Kinnow mandarin during 2017-18. Soil application of different sources of fertilizers in a randomized block design with three replications treatments were applied in standing crop (10 year old plants). Only soil application is tested and recommended in field crops. The soil treatments included split of recommended dose of fertilizers by different sources. The effect of different sources of nitrogen (N), phosphorus (P) and potassium (K) were observed in terms of number of flowers per twig, fruit set (%), number of fruits per tree, average fruit weight, fruit length and yield. The soil treatments results showed that Ammonium sulphate (2838gm) + DAP(695gm) +KNO₃(230gm) +ZnSO₄

3rd International Conference on “Global Initiative in Agricultural, Forestry and Applied Sciences for Food Security, Environmental Safety and Sustainable Development (GIAFAS-2021)”

(200gm) proved most effective in improving growth parameters and yield followed by Ammonium sulphate (2975gm) + SSP (2000gm) + KNO₃ (230gm) + ZnSO₄ (200gm) (548.33) and lowest results were observed in Urea (1520gm) +SSP (2000gm) +MOP (175gm). The application of different sources of fertilizers depicted significant response and the control showed minimum effect.

Key word: Kinnow mandarin, fertilizers, yield and quality

Breeding technology changes the landscape of ruminant industry

R.I.A. Raja Khalif

Faculty of Agro Based Industry, University of Malaysia

ABSTARCT

In recent years, Malaysia is facing a shortfall of animal production from 431,651 in 2015 to 359,200 numbers of goats in 2018. Besides that, according to Animal Breeding Policy, breeding improper and poor reproductions were the main reason for low productivity of livestock in Malaysia. Breeding management is essential to ensure proper management being carried out to optimize production. Farmers in East Coast Malaysia faced difficulties and high lost during rainy season (Nov – Jan) each year. However, reports showed smallholder farmers lack expertise and awareness about standard management of goats. Several factors are known to affect the reproductive performance of farm animals such as the biological type, physical environment and nutrition. In recent years, floods and rainy seasons have impacted animal health, which directly affected the health of new offspring. In fact, climate characteristics such as ambient temperature and rainfall patterns have a massive effect on pasture and food resource availability cycles throughout the year, and on the types of disease and parasite outbreaks among animal populations. High production animals are subject to greater influence by climatic factors, especially those that have increased under tropical conditions, due to high air temperatures and relative humidity. Thus, breeding management in which estrus is synchronized is vital to ensure animals were able to give birth at appropriate period. Applying breeding technology would change the landscape of ruminant industry. Breeding technology varies from semen collection to advanced technology such as cloning.

Key words: Breeding, Reproductive technology, structured breeding

Molecular Genetic Analysis for YMV Resistance in Blackgram(*Vigna mungo* L. Hepper)

K. R. SARAVANAN*, P. KARTHIKEYAN, S. VENNILA³, and S. SUGANTHI⁴

Department of Genetics and Plant Breeding

Faculty of Agriculture, Annamalai University, Chidambaram,

ABSTRACT

The present investigation on Molecular Genetic Analysis for YMV Resistance in Blackgram was carried out with five families namely P₁'s, P₂'s, F₁'s, F₂'s, F₃'s were performed with the following cross combinations KKM 1×VBN6, KKM 1 × VBN 8, ADT 5 × VBN 6, ADT 5 × VBN 8 was analysed for generation mean and single marker analysis. The result indicated the importance of dominance, dominance × dominance gene interaction in the expression of all the ten traits of interest in the entire cross combinations. It is suggested to postpone the selection to later segregating generations. Seventy progenies of the F₂ of ADT 5 x VBN 8 and two markers were subjected to simple regression approach. The SSR primer CEDG 180 was linked with percentage of disease infection had significant regression coefficient. The marker which is having a strongest relationship can be judged from its adjusted R² value which will give the overall percentage of variability of that particular trait explainable by marker. This marker as mapped in the F₂ population of 168 individuals at a map distance of 12.9 cM. The validation of this marker in ten MYMV disease resistant and seven MYMV disease susceptible genotypes has suggested its use in MAB for developing MYMV resistant genotypes in blackgram.

Keywords: Molecular validation, Single marker analysis, SSR markers.

Response of Manures and Inorganic Sources of Nutrient on Growth, Yield and Quality of Chickpea (*Cicer arietinum* L.)

V.K Singh, Ankur Sharma and Shreya Bhatt

Department of Soil Science

Shri Guru Ram Rai University, Dehradun, Uttarakhand. Pin - 248001

ABSTRACT

The present investigation entitled “Response of Manures and Inorganic Sources of Nutrient on Growth, Yield and Quality of Chickpea (*Cicer arietinum* L.)” was carried out to examine the response of both organic manure and inorganic sources of nutrient, in a single or combined application on growth, yield and quality of chickpea. The field experiment was conducted during winter season, 2019 at Agricultural Research Block of Shri Guru Ram Rai University, Dehradun, Uttarakhand. The experiment was carried out in completely randomized block design with 12 treatments and 3 replications. The investigation revealed that the performance of chickpea was significantly influenced by combined application of manure and inorganic nutrients (NPK). Among all the treatments treatment T₁₂ [FYM (5t/ha) + Neemcake (2t/ha) + 100% RDF] per ha was found best with respect to plant height (59.40 cm), dry matter accumulation per plant (30.66 g), number of pods per plant (50.14), number of seeds or grain per plant (58.13), test weight (25.21 g), grain yield per plant (18.99 g), grain yield (19.35 q per ha), straw yield (26.52 q per ha), harvest index (41.98%), nitrogen content in grain and straw (3.78% & 1.57) and protein content in grain and straw (23.63% & 9.80%). Based on overall performance, it can be concluded that under prevalent climatic conditions of Dehradun region, the combined application of inorganic fertilizer and manures (Integrated Nutrient Management) i.e. application of FYM (5t/ha) + Neemcake (2t/ha) + 100% RDF, can be recommended to an alternative to inorganic fertilizers for efficient nutrients use efficiency and achieving maximum growth, nodulation, grain yield and quality of Chickpea during Rabi season.

STATUS OF ENDANGERED AND EXTINCT MEDICINAL PLANTS OF UTTARAKHAND HIMALAYA: A REVIEW

Subhdara, Kamla Dhyani and Sobha

Shri Guru Ram Rai University Dehradun

ABSTRACT

The Indian Himalaya is rich in plant diversity including many medicinal plants, greatly valued by local inhabitants for health care needs. The Indian state Uttarakhand located in Himalayan hotspot having a huge wild diversity which occupies 17.3% of India’s total land area including 92.57% area under hills and 7.43% under plains. Geographically it is located between 28⁰43’-31⁰27’N latitudes and 77⁰34’-81⁰02’E longitudes. Due to its unique geographical location and different climatic condition, Uttarakhand Himalayas has rich biodiversity and variety of plant species and also has tremendous potential for domestication of medicinal plants that can be an important option for sustainable livelihood of the hilly people in coming future. Himalayan region of Uttarakhand is the habitat of major tribal communities such as Boxas, Marchhas, Jaunsaris, Shaukas, Tharus and raji, which use medicinal plants for curing the diseases and ailments through the use of natural medicine and believe that these are easily available, less expensive and have no side effects as compare to modern medicine.

According to one scientific study, the diversity under 1503 genera and 213 families of flowering plants, including 93 endemic species is harboured in various vegetation types, ranging from sub tropical forests in upper Gangetic plain and Shiwalik zone in the south to the alpine vegetation of trans-Himalayan cold desert in the north in Uttarakhand. Besides 487 species of ferns of which 15 species are endemic, 18 species of gymnosperms are also reported from the state.

Some of the famous endangered medicinal plants are Raktchandan, Chandan, Sarpghandha, Kalmegha Ritha, Vjradanti, Dhoop, Badritulsi, SitaAshok, Mithavish, Brahmi, Salampanja, and Buransh. At The present extinction rate is assumed to reached up to 5-7 species per year which is very much according to some estimates. The main reason behind extinction is change in climate and weather pattern, restricted gene variability, trampling and excessive grazing by domestic as well as wild animals, global warming, smuggling/illegal extractions, unplanned construction

and lack of awareness, this extinction will have very adverse effects for future. After declaration of Uttarakhand as an Herbal State, the government took initiatives for sustainable cultivation of MPs in a phased manner.

Key Words- Endangered, Extinction, Endemic, Medicinal Plants, sustainable

Impact of Vermicompost based Integrated Nutrient Management on Productivity Enhancement of Broccoli and Soil Properties under Hill Agro-ecosystem of North East India Popiha Bordoloi

Krishi Vigyan Kendra Ri- Bhoi, ICAR (RC) for NEH Region, Umiam -793103, Meghalaya..

ABSTRACT

The study was conducted at Ri-Bhoi District of Meghalaya in three selected villages to study the impact of vermicompost based integrated nutrient management on productivity enhancement of Broccoli (*Brassica oleracea* var. *italica*) and its effect on soil nutrient status. The experiment was conducted by following 3 treatments: T1: Vermicompost @ 1.0 t/ha + 50% RDF (RDF: N: P₂O₅: K₂O::120: 80: 60 kg/ha), T2: Vermicompost@ 2.0 t /ha + Lime @ 500kg/ha + 2% urea spray at branching & pod initiation stage, T3: Farmers practice (imbalance fertilizer with N: P₂O₅: K₂O:: 50:20:10 kg/ha) with 5 replications following randomized block design during the year 2017 and 2018. From the results it is revealed that Vermicompost @ 1.0 t/ha + 50% RDF showed significant increase in fruit yield and B.C ratio followed by Vermicompost@ 2.0 t /ha + Lime @ 500kg/ha + 2% urea spray at branching & pod initiation stage and Farmers practice. Moreover, improved soil nutrient status was achieved in T1 followed by T2 and T3 in the soil after the harvest of the crop as compare to the initial stage of soil before the implementation of Treatments.

Key words: On Farm Testing, Vermi-compost, INM, Broccoli.

Evaluation of Potential Biocontrol Bacterial Strains against *Verticillium* Wilt of Cotton

Kamaldeep Kaur, Ashish Vyas

School of Bioengineering and Biosciences, Lovely Professional University, Phagwara, 144411, Punjab, India

ABSTRACT

Cotton is an important cash crop growing at economic level throughout the world. Significant loss of yield occurs by attack of most devastating soil borne pathogenic fungus *Verticillium dahliae*. *in vitro* and *in vivo* study has been conducted to check the efficacy of potential biocontrol bacterial strains against *V. dahliae*. Biocontrol potential of antagonistic isolates was assessed on following criteria: (1) *in vitro* inhibition of *Verticillium dahliae* by Dual culture assay, (2) activities of cell wall degrading enzymes including protease, cellulase, and chitinase. (3) *in vivo* field trials under poly house and natural field conditions. *Pseudomonas aeruginosa*, *Lysinibacillus macroides* and *Bacillus subtilis* have shown most positive *in vitro* antagonism during “Dual Culture Assay”. Seed bacterization with *Pseudomonas aeruginosa* helps to reduced wilt symptoms in natural fields and pot trials more than *Lysinibacillus macroides* followed by *Bacillus subtilis* when compared to control plants (non-bacterized). In both pot experiments and field trials, growth parameters and yield of cotton were significantly higher in seed bacterized plants (*Pseudomonas aeruginosa*.) than non-bacterized seeds(control). Most significant biocontrol efficacy has been recorded in *Pseudomonas aeruginosa* followed by *Lysinibacillus macroides* and *Bacillus subtilis* with 73.6%, 68.5% and 62.5% biocontrol protection percent, respectively under natural field conditions. Results depicts that a combinatorial study of soil solarization and seed treatment with *P. aeruginosa*, *L. macroides* and *Bacillus subtilis* plays a significant role to control wilt disease of cotton in naturally infested fields and improve growth parameters.

Agronomic performance of Lentil under the various weed management strategies

Priyanka Bankoti, Mansi Nautiyal*

School of Agricultural Sciences, Shri Guru Ram Rai University, Dehradun, U.K-248001.

ABSTRACT

The search for cultivation practices that provide increased lentil yield has been recurrent. From this context, the objective of this study was to evaluate the agronomic performance of lentil under the various weed management strategies. One field experiments was conducted in a randomized block design (RBD, with four replications and nine treatments i.e., i.e., quizalofop ethyl @ 55gm, ha as PE, imazethapyr @ 37gm/ha as PE, Chlorimuran ethyl @ 4.5 gm/ha as PPI, pendimethalin @ 1.5 kg as PE, Pendimethalin + Imazethapyr (ready – mix) @ 0.20 kg /ha, Pendimethalin + Imazethapyr (ready – mix) @ 1.5 kg a.i/ha as PE, Pendimethalin @ 1.5 kg/ha as PE + Hand weeding at 40 DAS, Hand weeding thrice at 35, 65 and 90 DAS and control plot. In one year growing season, data were collected on the population of lentil, total yield, and harvest index, population and NPK uptake of weed species. Weed control applications significantly decreased population of weeds after 65 days. The highest grain and straw yield were recorded 1865 kg/ha and 3099 kg/ha respectively during T8(Hand weeding thrice at 35, 65 and 90 DAS) treatment and the lowest 1380 kg/ha and 2582 kg/ha of grain and straw yield was recorded during T3 (Chlorimuran ethyl @ 4.5 g a.i/ha as pre plant incorporation) treatment. The prominent weeds found in the experimental plot were *Cannabis sativa*, *Cynodon dactylon*, *Chenopodium album* and *Parthenium hysterophorus* etc: and these weeds together constituted 57 percent of the total weed population.

Keywords: *Lentil, Weed, agronomic, population, herbicides*

PLANT GROWTH PROMOTING RHIZOBACTERIA (PGPR), ITS IMPORTANCE AND FUTURE PERSPECTIVES IN AGRICULTURE

Shalini Kotiyal¹ and Manjusha Tyagi*

*Microbiology, SBAS, SGRR, University, Dehradun¹, Associate Professor, Microbiology, SBAS, SGRR, University**

ABSTRACT

The public's interest in food habits has shifted dramatically in recent years. People are becoming more aware of their eating habits. People are now aware of the negative consequences of chemical fertilisation and pesticides, as well as their detrimental effects on agricultural output. As a result, there has been a lot of interest in environmentally friendly and sustainable agriculture. By delivering nutrients to plants and regulating biotic and abiotic stress, PGPR promotes productivity and soil fertility. PGPR is involved in nitrogen fixation by symbiotic and free-living rhizobacteria, phosphate solubilization, secret phytohormones, and biocidal metabolites generated by cyanobacteria. It is also utilised to combat plant diseases by producing hydrogen cyanide (HCN), fungal cell wall disintegrating enzymes (eithinase &-1,3-glucanase), and enhancing soil structure and organic matter content. This review article shows the beneficial role of PGPR as biofertilizer, bioinoculator, biocontrol agent and biopesticides over chemical fertilizers. Crop productivity is heavily influenced by environmental conditions. Unprecedented rain, flooding, and drought conditions have harmed agricultural crops in recent years. So, by using bioinoculents, PGPR enhances soil fertility, controls pathogens with biocontrolling agents, and manages biotic and abiotic stress in a variety of ways. Plant biotechnology advancements have made it easier to improve the genetics of both plants and microorganisms. Researchers are now concentrating their efforts on isolating and identifying new microorganisms in the soil, as well as testing their positive effects on plant development and environmentally friendly behaviour.

Performance of wheat (*Triticum aestivum*) varieties under cold stress condition

Girish Chandra^{*1}, Radha Upadhyay², Kamla Dhyan³ and Sobha Bisht¹

^{1,2}Department of Seed Science and Technology, ²Agronomy, ³Plant Physiology
School of Agricultural Sciences, SGRR University, Dehradun, India- 248001.

ABSTRACT

Wheat is playing an outstanding role in feeding the hungry people of the world and an important crop for global food security. In India, wheat is the second most important cereal crop next only to rice and a key crop of the green revolution and post green revolution era. With the changing climatic conditions it is essential to know the performance of wheat crop under stress conditions. The present investigation was conducted during the Rabi season of 2020-2021 at Agricultural Research Farm of Shri Guru Ram Rai University, Dehradun, India to study the performance of wheat varieties under cold stress condition. The experiment was laid out in factorial randomized block design with three replications. The treatments comprises five sowing dates *viz.* 5th November (T₁), 15th November (T₂), 25th November (T₃), 5 December (T₄) and 15th December (T₅) and two varieties *i.e.* Unnat PBW 343 (V₁) and PBW 502 (V₂). All agronomic practices like weeding, irrigation, nutrition etc. were used as per the crop requirements. The experimental data show that the plant height (101.4 cm), number of leaves per plant (4.56), plant dry-matter accumulation (189.0 g), number of seed ear⁻¹ (76.30), test weight (39.72 g) and seed yield (43 qha⁻¹) was recorded maximum with 15th November sowing. The variety Unnat PBW 343 performs was performed better than variety PBW 502 with respect to all growth and yield parameters of plants. Based on experimental finding, it can be concluded that under prevalent climatic conditions of Dehradun region, the variety Unnat PBW 343 and 15th November sowing time is best for higher yield of wheat crop as compared to all other treatments.

Key words: Sowing date, wheat, varieties and yield

Ways to encourage participation of farmwomen in family welfare and agricultural development

Nidhi B. Thakur¹ and J. B. Patel²

¹Dept. of Agricultural Economics & Extension, Lovely Professional University, Punjab - 144411

² Dept. of Agricultural Extension and Communication, BACA, AAU, Anand- 388 110

ABSTRACT

This present study entitled “**Ways to encourage participation of farmwomen in family welfare and agricultural development**” was conducted with a sample of 200 respondents. The ex-post facto research design was used for the research study. The study was carried out in Vadodara district of Gujarat. From these four Talukas were selected on the basis of area under higher cotton production viz, Karjan, Dabhoi, Sinor and Padara. The study was conducted to know several ways to increase participation of farmwomen in agricultural development. The finding is suggested that for the rising the participation of farmwomen in agricultural development, the variables such as occupation, attitude towards agricultural development, social participation, management orientation and attitude towards family welfare should be emphasized. All these five variables predicted 60.10 per cent of the total variation in the extent of participation of farmwomen. It could be concluded that occupation, attitude towards agricultural activities, attitude towards family welfare, information seeking behavior, management orientation and mass media exposure of the respondents were the key variables in exerting considerable direct, indirect and substantial effect on participation of farmwomen in family welfare and agricultural development.

Seed Vigour Tests on Different Cultivars Of *Phaseolus Vulgaris* Grown In Chamoli District Of Uttarakhand, India

***Sobha and J.S. Chauhan and Kamla Dhayani**

School of Agriculture Sciences, Department of Seed Science and Technology SGRR University Dehradun, Uttarakhand, India

Department of Seed Science and Technology, HNB Garhwal University Srinagar Garhwal (A central University)

School of Agriculture Sciences, SGRR University Dehradun, Uttarakhand, India

ABSTARCT

Rajmash (*Phaseolus vulgaris* L. family; fabaceae) is also known as kidney bean/ French bean. It is an annual plant and cultivated throughout the world for their edible beans. The present study was conducted to investigate the effect of seed vigour by germination test of different cultivars of *Phaseolus vulgaris* grown in Chamoli district of Uttarakhand. The experimental material constituted a collection of 7 cultivars (Red small, Red big, Grey, Pink, Yellow, Brown, White) of *Phaseolus vulgaris*. The seed samples of seven cultivars of *Phaseolus vulgaris* were taken from Joshimath, District Chamoli Garhwal Uttarakhand. Morphological aspects viz; seed weight, seed moisture content, seed density and seed diameter were recorded prior to germination test of *Phaseolus vulgaris* at Seed Testing Laboratory, Department of Seed Science and Technology, H.N.B Garhwal University. Seeds were sterilized with 0.2% sodium hypochlorite solution for germination test. Two replicates of each variety and 25 seed in each replicates were kept in petriplates on whatman filter paper. Petriplates were kept in seed germinator at 25 ± 2°C until final count. The number of normal seedling was counted at the final count, higher the number of normal seedlings greater is the seed vigour. The germination percentage was found 100% in five cultivars, and the other two cultivars showed 96.66% in yellow seeds and 68.33% in Grey cultivar of *Phaseolus vulgaris*. Brown cultivars represented maximum dry weight of root (0.029gm) while minimum dry weight of root has been recorded in yellow cultivar (0.01353gm). Maximum vigour index were recorded in brown cultivar and minimum was recorded in pink cultivar. The findings from the study indicate that brown cultivar of *Phaseolus vulgaris* is highly vigours

Keywords: *Phaseolus vulgaris* , germination, morphological , physiological, Variations.

Open heap compost system: A promising traditional practice for sustainability of Hill-agro-ecosystem in Indian Himalaya's

*Akshat Uniyal¹, Krishna K Singh² and N S Bisht³

1. Laboratory of Microbiology, Department of Botany and Microbiology, HNB Garhwal University, Srinagar (G) Uttarakhand-246174, India

2. Department of Horticulture, HNB Garhwal University, Srinagar (G), Uttarakhand

3. Department of Botany, BGR Campus Pauri, HNB Garhwal University, Srinagar (G), Uttarakhand, India

ABSTRACT

Present investigation depicts assessment of microbial diversity, its succession, plant growth promoting activity and physico-chemical properties of the manure during decomposition of traditional open heap system and its impacts on soil health in Indian Himalayas. Indigenous method of manure preparation was followed for this study; a heap was formed at experimental site using approximately 2 tons live-stock waste. Composite samples of manure and soil were collected to study biotic (Microflora) and abiotic (*i.e* nutrients, pH, EC, Temp.) components.

The temperature of heap during decomposition was observed moderate thermophilic. Therefore, it plays a crucial role in favouring growth of a diverse beneficial microbiota. The pH profile of heap was found alkaline throughout the process while the maximum EC (Electric conductance) was observed as 8.72 ± 0.23 dS m⁻¹. The range of total manure nitrogen and phosphorus was observed from 1.20 ± 0.2 to $1.86 \pm 0.08\%$ and 1.43 ± 0.02 to $1.78 \pm 0.01\%$ respectively. The highest value for potassium was around $3.06 \pm 0.1\%$.

A total of 250 dominant bacterial strains belonging to 34 genera were observed to participate in decomposition process in which highest (57.2%) isolates were belongs to *Enterobacteriaceae*, followed by *Pseudomonadaceae*, *Bacillaceae*, *Lactobacillaceae*, *Moraxellaceae*, *Planococcaceae*, *Paenibacillaceae* and *Bukholderiaceae*. In case of Mycoflora, a total of 102 fungal entities belong to 11 genera were isolated from developing in which members of Duteromycetes (*i.e. Aspergillus and Penicillium*) were the most dominated with isolation percentage of 22 and 25, respectively. A total of 27.4% fungi and 18.8% bacteria were found to have phosphate solubilization potential, while 44.1% of fungi were observed for IAA production and 72% bacteria were positive for ammonia production. A high microbial load of beneficial microflora (278×10^7 CFU g⁻¹ for bacteria and 24×10^5 CFU g⁻¹ for fungi) in developing heap is indicative of promising manure quality. Microbial biomass carbon (MBC) of manure amended soil observed increased against untreated plot and varied from 352 to 434 $\mu\text{g g}^{-1}$ soil in manure amended soil.

Study was aimed to investigate the significance of traditional open heap system. Results indicated that it not only facilitates growth of beneficial microbial diversity but also accelerate biodegradability of manure for availability of nutrients to sustain long term fertility of agriculture lands. Physico-chemical and microbiological study of open heap system of traditional composting practice validates that this ages old practice encompasses promising option for low land holder farmers in hilly terrains of Uttarakhand.

Key words: Plant growth promoting bacteria, Microbial biomass, Phosphate solubilisation, Electric conductance

Applications of biodegradable polymers in food packaging industry

Mohammad Amir^{1#}, Roohi¹, Mohammed Kuddus^{2*}

¹Protein Research Lab, Department of Bioengineering, Integral University, Lucknow, India

²Department of Biochemistry, University of Hail, Hail, Kingdom of Saudi Arabia

ABSTRACT

Plastics made from fossil fuels are ubiquitous in modern society. From the last 50 years, plastics have been widely used to manufacture packaging materials because of their performance and ease of production. However, the increased use of synthetic packaging films has led to severe ecological problems due to their total non-biodegradability. With the development of food processing industries, there has been a significant increase in the need for petroleum-based packaging materials for use in the food industry. Biopolymers, which breakdown fast in the environment and have characteristics that are similar to conventional polymers, have the potential to be utilized as a solution to the issues caused by plastics. Biodegradable resources can replace conventional plastics as they are completely degradable in nature and give high mechanical properties. PHA, PHB, starch, cellulose, and their derivatives are now extensively used for food packaging. Blending of these biodegradable polymers with other plasticizers increases their mechanical strength, improves their gas barrier qualities, and increases production, making them more cost-effective. Another application of biodegradable materials is that they are also used in edible food packaging. It is estimated that the production of biodegradable materials will reach approximately 2.5 million tonnes in 2025. In terms of value, the biodegradable food packaging market is estimated to reach the mark of 249.5 billion USD in 2025, as compared to 174.7 billion USD in 2020, with a record increase of 7.4% in CAGR.

Keywords: Food packaging; Food packaging material; Biodegradable material; PHB; Food coating; Edible food packaging

Impact of planting methods and weed control practices on growth, yield and quality of paddy

Avinash Kumar Singh, RS Yadav, Deepak Kumar, Gyanendra Kumar and Sunil Kumar

Department of Agronomy, A.N.D.U.A.&T., Kumarganj, Ayodhya, (U.P.)

ABSTRACT

An experiment was carried out during the kharif seasons of 2018 and 2019 to find out Influence of planting methods and weed control techniques on growth, yield and quality of paddy. Four crop planting methods viz. transplanted rice, direct seeded rice, drum seeded rice and system of rice intensification (SRI), and four weed control techniques viz. (Bispyribac sodium 25 g ai ha⁻¹ at 25 DAS/T, Bispyribac sodium 25 g ai ha⁻¹ at 25 DAS/T + hand weeding at 40 DAS/T, Two hand weeding 20 & 40 DAS/T and Weedy check were tested in Splt Plot Design with three replications. Maximum plant height, number of shoots/m², dry matter accumulation, grain yield, nitrogen uptake by crop was recorded in hand weeding (20 and 40 DAS/T) than that of other weed management practices. Among the planting methods, SRI method exhibited maximum plant height, number of shoots/m², dry matter accumulation, grain yield, nitrogen content in grain and straw

Keywords: Rice, transplanting, SRI and weed management

Morphological assessment of Asian elephant (*Elephus maximus*) ivory retrieved from Dharamjaigarh Forest Division of Chhattisgarh, India.

Aman Kumar¹, S.S. Dhuria¹, Pranay Mishra²

¹Department of Forestry, Wildlife and Environmental Sciences, Guru Ghasidas Vishwavidyalaya, Bilaspur, Chhattisgarh, India

²Divisional Forest Officer, Raigarh, Chhattisgarh, India

ABSTRACT

Asian Elephant tusk size varied between elephant groups. Tusk homogeneity within social groups and often high genetic similarity with social group suggest that tusk size may be heritable; Patrick (2015). The pulp cavity has abundant blood supply as compared to the teeth. The rate of elephant tusk is matter on which very little data is available, Perry (1954). Dharamjaigarh Forest Division of Chhattisgarh is also facing human elephant conflict (HEC) resulting in the loss of life of animals and human both side.

In this study the Ivory of the eight elephant, total sixteen ivories were examined morphologically. The eight pairs of elephant ivory were collected at Dharamjaigarh forest division, after the death of the elephants in two ranges namely Dharamjaigarh range and Chhal range. The Dharamjaigarh forest division is consisting of six different ranges namely Dharamjaigarh, Chhal, Kapu, Boro, Lailunga and Bakaruma. Mostly the movements of Elephants is seen in all these ranges because presence of dense forest which provide protection and good availability of food material and water. Morphological study includes the length, weight, Diameter & tapering of the tusk. From the Preliminary offence report (POR) information the age and the gender is obtain and on the basis of the data collected the relation between different parameter is seen and tried to conclude some result from it. In the present study, we observe that the elephants are also using the right tusk more; weight of the right tusk is also more than the left one. We observed that the harvesting of tusk is inappropriate and scientific harvesting is needed. So that material can be preserved for further study.

Keywords: Asian elephant, *Elephus maximus*, Ivory, Tusk, Morphological study, POR

Antimicrobial Treatment on Cellulosic Fibre using Agro Waste (Lemon Peel)

Sushila^{*a}, Nisha Arya^a, Sarita Devi^b, Kamla Malik^c, Vivek Singh^a

^aDepartment of Textile & Apparel Designing, COHS, CCS HAU, Hisar, Haryana, India

^bDepartment of Fashion Design, Mandsaur University, Mandsaur, MP, India

^cDepartment of Microbiology, COBS, CCS HAU, Hisar, Haryana, India

ABSTRACT

Concern in environment-friendly textile processing techniques has been augmenting in recent years. Natural products are environment friendly, low toxic and less allergenic owing to the presence of large number of structurally diverse active compounds which makes natural agents as promising options for the development of antimicrobial protective textiles. The purpose of the present study was to investigate the effect of lemon peel treatment on microbial resistant property of cotton fabric. It was found that the cotton fabric treated with lemon peel extract showed 97.89, 98 and 97.16 percent reduction in the growth of *P. aeruginosa*, *E. coli* and *X. campestris* bacteria, 93.49 and 95.83 percent reduction in the growth of *B. subtilis* and *S.*

3rd International Conference on “Global Initiative in Agricultural, Forestry and Applied Sciences for Food Security, Environmental Safety and Sustainable Development (GIAFAS-2021)”

aureus bacteria whereas treated fabric showed 94.99, 90.41 and 93.44 percent reduction against *A. clavatus*, *A. flavus* and *A. awamori* fungal strains, respectively. Lemon peel extract treated cotton fabric was further characterized by FESEM and FTIR spectra to study the changes occurred in the fibre structure after treatment.

Keywords: Cotton, microbial Resistance, lemon peel, FESEM, FTIR analysis.

OPTIMIZING SUITABLE SUMMER PULSES AND SOWING TIME FOR RICE FALLOW SEQUENCES.

Mayanglambam Bishonath Singh

Department of Agronomy, Dr. Rajendra Prasad Central Agricultural University, Pusa, Bihar, 848125

ABSTRACT

In North Eastern Region of India, farmers mostly go for monocropping of rainfed rice. Due to various reasons such as, cultivation of long-duration rice varieties, water logging and excessive moisture, non-availability of seeds of short duration varieties of Rabi crops, aberrant weather condition and unknown optimum sowing window. Hence, keeping in the view the experiment was entitled to identify suitable summer pulse(s) for lowland rice fallow and to determine their optimum sowing date, the experimental study was undertaken with four dates of sowing viz- 19/2/2016, 26/2/2016, 4/3/2016 and 11/3/2016 and four summer pulses of cowpea, frenchbean, greengram and blackgram with replicated thrice. From the experimental study, higher grain yield of all the summer pulses (cowpea, frenchbean, greengram and blackgram) were obtained when sowing was done on 4th March (0.91 t ha⁻¹, 0.71 t ha⁻¹, 0.33 t ha⁻¹ and 0.35 t ha⁻¹ respectively). Whereas lower yield was recorded with either early (19th and 26th February) or late sowing (11th March). The comparative performance of summer pulses was assessed in term of rice equivalent yield. Among the four pulses frenchbean was recorded higher rice equivalent yield (3.89 t ha⁻¹) but greengram recorded lower rice equivalent yield (1.36 t ha⁻¹). From the different dates of sowing, crop sown on 4th March recorded significantly higher rice equivalent yield (2.60 t ha⁻¹) while minimum rice equivalent yield was recorded when sowing was done on 11th March (1.39 t ha⁻¹). From the experimental study, it can be concluded that cowpea perform better over other pulses followed by frenchbean when it was sown on 4th March.

Keywords: Sowing time, rice equivalent yield, yield, pulses.

Comparison of Open Source DEM's for Morphometric Analysis of micro watersheds: a case study from the midlands of Kerala

Md. Majeed Pasha and Sathian K.K.K.

Department of Soil and Water Conservation Engineering, KCAET, Tavanur, Kerala, India

ABSTRACT

Morphometric analysis with the help of remote sensing and GIS is now widely used to prioritise micro watersheds for planning interventions for soil and water conservation. DEM is the main digital data used to perform the morphometric analysis. There are different types of DEMs available to perform morphometric analysis using GIS techniques. But, no authentic information is available on the degree of accuracy levels of these DEMs to quantitatively determine various morphometric parameters for the watersheds in Kerala, with typical undulating and sloping terrain features. Hence, this research has been initiated to evaluate the quality of three popular DEMs viz. SRTM, CARTOSAT and ASTER, each with 30 m spatial resolution. Two small sub watershed of Bharathapuzha river basin have been chosen for the study which are lying near to Valanchery town in Malappuram district. More than 21 morphometric parameters including drainage network, basin geometry, basin texture and basin relief characteristics were computed using these three types of DEMs and the outputs compared with google earth map. The results shows that the SRTM 30m DEM is characterized by higher accuracy compared to CARTOSAT and ASTER and has got better matching with google earth map data sources.

Keywords: watershed, morphometric analysis DEM, geospatial techniques

Characterisation and Prioritization of Micro watersheds Using Geospatial Techniques: A Case Study on river Bharathapuzha, Kerala

Md. Majeed Pasha and Sathian K.K.K.

Department of Soil and Water Conservation Engineering, KCAET, Tavanur, Kerala, India

ABSTRACT

Watershed based interventions are essential for the sustainable land and water management of any region. Watershed prioritisation is a must for the efficient utilisation of available monetary and human resources. One of the most common means of prioritisation is through morphometric analysis as hydrological processes or watershed responses depend on morphometric characteristics of the watersheds. The study contains morphometric analysis of a few number of micro

3rd International Conference on “Global Initiative in Agricultural, Forestry and Applied Sciences for Food Security, Environmental Safety and Sustainable Development (GIAFAS-2021)”

watersheds of river Bharathapuzha of Kerala state. With the help of ArcGIS software and SRTM DEM, all the basic morphometric characteristics and derived morphometric characteristics of 10 micro watersheds are determined and then scores are assigned to the parameters. Finally, combined parameter scores are determined and ranking of each micro watershed is done. The priority scores between watersheds show considerable variation which is an indication of the efficacy of the methods employed. Once the ranking of the micro watersheds are done objectively and scientifically it would be a great support to the soil and water conservationist and planners. This study gives an insight into the applicability of the method to a mid land region in the state of Kerala, India.

Keywords: Watershed, morphometric analysis, prioritisation and geospatial techniques

Seasonal abundance of large white cabbage butterfly from mid hills of Garhwal, Uttarakhand **Anshuman Semwal**

College of Horticulture, VCSG UHF, Pauri Garhwal Uttarakhand, India

ABSTRACT

An investigation was carried out to study the seasonal abundance of large white cabbage butterfly (*Pieris brassicae*) at Vegetable Research and Demonstration Block, Department of Entomology, College of Horticulture, VCSG UHF, Bharsar, Pauri Garhwal during the year 2019. *P. brassicae*, first appeared on the cabbage crops from 13th standard metrological week (SMW) and the population of eggs, larvae and adults were recorded as 75.81 eggs/10 plants, 51.90 larvae/10 plants and 7.54 adults/10 plants respectively. During May (18th to 25th SMW) the population increased from 116.67 eggs to 152.48 eggs, 110.54 to 163.21 larvae and adult population from 7.54 to 13.45 adult/10 plants. As regards the correlation studies, correlation coefficient (*r*) of maximum temperature with eggs, larvae and adult was found 0.676, 0.641, 0.464 respectively and the correlation coefficient (*r*) of minimum temperature with egg, larvae and adult population were found 0.667, 0.626 and 0.516, respectively. There was negative impact of morning and evening relative humidity on number of eggs, larvae and adult, the values were -0.490, -0.494, -0.067 and -0.180, -0.162, -0.22, respectively. The correlation of sunshine hours with eggs, larvae and adult were found to be 0.393, 0.267 and 0.150, respectively. Impact of rainfall on number of eggs, larvae and adults were as follows -0.274 (eggs), -0.236 (larvae) and -0.201 (adults), respectively.

Keywords: Cabbage butterfly, seasonal abundance, climate, weather parameters, temperature, *Pieris brassicae*.

PRODUCTIVITY OF MALBAR NEEM (*Melia dubia*) BASED AGROFORESTRY SYSTEM IN NORTHERN TRANSITIONAL ZONE OF KARNATAKA

Chavan, R. L., Pawar, K. N., Hundekar, S. T., Vasudev L. and Mokashi, M. V.

MARS, University of Agricultural Sciences, Dharwad-580005, Karnataka

ABSTRACT

Agroforestry plays an important role in the economy of arid and semi-arid regions due to high risk involved with arable farming, which is affected by low and highly variable rainfall, low soil fertility and high wind velocity. *Melia dubia* is fast growing tree species with multipurpose benefits and suitable for plantation programme under various agro-climatic conditions. The efforts were made to assess its performance and productivity soybean and safflower grain yield under different spacing of Malbar neem agroforestry system.

Field experiment was conducted during Kharif / Rabi seasons from 2010 to 2019 with the different plant densities at Main Agricultural Research Station, University of Agricultural Science, Dharwad to know the feasibility of cultivation of Soybean / Safflower in *Melia dubia*. There were seven treatment combinations comprising intercrop of Soybean in Kharif and Safflower in Rabi season sown in different spacing's of *Melia dubia* with Soybean and or Safflower alone as control.

Results revealed that, sole soybean-Safflower recorded significantly higher grain yield. Among density of spacing association with *Melia dubia* planted at 4 m X 4 m spacing was recorded higher soybean grain yield in Kharif and safflower yield in rabi. The maximum height and diameter of breast height were recorded under 4 x 4 m spacing (13.03 m and 25.40 cm respectively) and 4 m x 3.5 m spacing (12.97 m and 24.40 cm respectively) when compared to other narrow spacings. The basal area and volume of the trees were registered significantly higher in 4 x 4.0 m spacing (0.049 m²/pl and 0.383 m³/pl respectively) followed by 4 x 3.5 m spacing (0.044 m²/pl and 0.342 m³/pl respectively) when compared to other spacings tried.

In conclusion, the grain yield of soybean-safflower grown during the initial years was significantly higher in the 4 m x 4 m spacing when compared to other spacings. Both crops (soybean-safflower) grain yield were decreased gradually in the narrow spacings during the later years due to the lack of light, moisture, nutrients and crown shade. *Melia dubia* planted at the spacing of 4 m X 4 m yields higher wood volume and economic return due to higher wood volume. This can be practiced in larger scale for better monetary generation

Keywords: *Melia dubia*, Agroforestry system, Field crop, Productivity

PROVENANCES VARIABILITY IN GROWTH AND PRODUCTIVITY OF NEEM (Azadirachta indica (A. Juss.) IN NORTHERN TRANSITIONAL ZONE OF KARNATAKA

Chavan R. L., Pawar K. N., Nayak B.G., Hundekar S. T. and Mokashi, M. V.

MARS, University of Agricultural Sciences, Dharwad-580005, Karnataka

ABSTRACT

Provenance variability is one of the important aspects of nature. A growing stock is bound to have variations. Variability is the key for improvement in any biological system. Neem (*Azadirachta indica*) is an evergreen, multipurpose tree native to the Indian subcontinent and South-east Asian countries. Seeds from proven sources trees are the backbone of any successful tree improvement and afforestation programme. In order to adopt strategies of conservation and improvement, it is necessary to compare and estimate the amount of genetic variation in tree height, DBH, Volume and seed oil of Neem resources and identify promising provenances.

The National Provenance Trial on Neem was established in 1991 at University of Agricultural Sciences, Dharwad, Northern Transitional Zone of Karnataka, with 20 seed sources. During 1991, Neem provenance of Bijapur, followed by Raichur, Bagalkot, Bailahongal, Arabhavi, Sankeshwar, Bhimarayanagudi, Gulbarga, Siraguppa, Hagari, Gangavati, MARS Dharwad, Jhansi, Dharwad Farm, Prabhunagar, Hanumanamatti, Annigeri, Gadag, Kallolli and Belavatagi seedlings were planted in a Randomized Block Design (RBD) with three replications. The 9 plants of twenty provenance were planted at 5 x 5 m spacing and are replicated thrice.

The Analysis of variance of data on 30 year old neem trees indicated highly significant differences among provenances for height, clear bole height, diameter at breast height, volume, crown scores and qualitative traits viz., azadirachtin, seed yield and oil content. while non-significant differences for survival rate, straightness and roundness of stem and health characteristics. Height and DBH growth of Neem trees ranged from 13.83 to 16.60 m and 28.02 to 36.07 cm among the provenance. Among the seed sources, Bijapur followed by Bagalkot, Raichur and Dharwad seed sources were the exhibited best for all the quantitative and qualitative parameters studied. It is possible to develop high wood volume and fruit yielding varieties of neem and having higher azadirachtin and oil content. Genetic Analysis showed low heritability (broad sense) estimates for the characters on height, dbh, volume and crown characters (below 30 per cent), while moderate to high estimates of heritability for seed yield (50.50 per cent) and seed oil content (31.16 per cent) characters. Neem seeds were processed for the extraction of azadirachtin. Azadirachtin content varies from 0.05% to 4.24% in seeds from different provenance.

Bijapur followed by Bagalkot, Raichur and Dharwad seed sources were the exhibited best neem and ecologically more suitable among provenance. It is suggested that selections could be made from superior trees of individual provenances in order to have a broad base for genetic improvement of Neem in Karnataka.

Keywords: Neem, provenance, productivity, Seed oil, wood volume

STUDIES ON GENETIC VARIABILITY FOR YIELD AND YIELD CONTRIBUTING TRAITS IN COWPEA (*Vigna unguiculata* (L.) Walp)

***P. D. Waghmare¹, U. B. Pethe², B.S. Thorat³ and V.V. Dalvi⁴**

Dr. Balasaheb Sawant Konkan Krishi Vidyapeeth, Dapoli (MS), India.

ABSTRACT

The experiment was conducted with thirty cowpea genotypes collected from various states of India in *Rabi* 2016 in Randomized Block Design (RBD). Wide range of variability was present in the genotypes of cowpea under study in Konkan condition. The range of GCV and PCV was 2.10% to 25.72% and 2.65% to 25.93% respectively. The estimates of phenotypic, genotypic and environmental variances revealed that phenotypic variances were higher in magnitude over the respective genotypic variances for all the characters under study. PCV and GCV were high for straw yield per plant and grain yield per plant. The broad sense heritability ranged from 53.16% to 98.41%. A high estimate of broad sense heritability was observed for number of pods per plant, hundred seed weight, number of seed per plant and seed yield per plant. The genetic advance and genetic advance as per cent of mean (GAM) was ranged from 0.56% to 18.99% and 3.43% to 52.57% respectively. Heritability along with genetic advance is more useful for selection than the heritability alone.

Keywords: Cowpea variability, GCV, PCV, genetic advance, heritability and GAM.

Epidemiology of sesamum phyllody

Sunita J. Magar, Kamble S.M. and Somwanshi S.D.

Department of Plant Pathology, College of Agriculture, Latur, VNMKV, Parbhani- Maharashtra-413512

ABSTRACT

Sesamum (*Sesamum indicum* L.) is one of the oldest oilseed crops and has been cultivated in ancient's times. The crop is affected by sesamum phyllody disease and transmitted by leaf hopper (*O. albicinctus*). Yield losses up to 34 per cent or even

3rd International Conference on “Global Initiative in Agricultural, Forestry and Applied Sciences for Food Security, Environmental Safety and Sustainable Development (GIAFAS-2021)”

100 per cent, in case of severe incidence (Sarwar and Haq, 2006). Present investigation on the phyllody disease was carried out during 2019-20 at the department of Plant Pathology, College of Agriculture, Latur. Symptoms observed due to sesamum phyllody i.e. floral virescence, floral proliferation, drying of phyllody affected flower, withes broom, shoots apex fasciations, stunted growth of infected plant, sepals and petal converted into leaf like structure etc. The hosts observed were brinjal, periwinkle, chickpea and parthenium during investigation. Disease incidence and leaf hopper population observed was 25.06 per cent and 0.83 leaf hopper per plant in variety JLT-408 and 17.25 per cent and 0.75 leaf hopper per plant in variety Madhuri. The yield loss was high at 45 days after sowing. In the cultivar JLT-408 maximum losses 16.81 per cent were recorded when, it was infected at 45 days after In the cultivar Madhuri maximum losses 12.94 per cent recorded when, it was infected at 60 days after sowing The correlations between leaf hopper population and disease incidence were found positively correlated in both JLT-408 and Madhuri but non significant. Correlation between climatic factors and leaf hopper population was worked out in both varieties JLT-408 and Madhuri revealed that the correlation between temperature max. and min. was negatively correlated with leaf hopper population and was significant in JLT-408 and non significant in variety Madhuri. The correlation between climatic factor like Temperature (max. and min.) and Relative humidity % (am and pm) with phyllody disease incidence was negative and significantly correlated in variety JLT-408.

Keywords: Sesamum phyllody, leaf hopper (*O. albicinctus*), correlation, yield losses, Disease incidence

Management of sesamum phyllody by adjusting date of sowing

Sunita J. Magar, Kamble S.M. and Somwanshi S.D.

Department of Plant Pathology, College of Agriculture, Latur, VNMKV, Parbhani- Maharashtra

ABSTRACT

Sesamum belongs to family Pedaliaceae is one of the most important crop in India. It is grown in India since ancient times several diseases infecting sesamum, phyllody caused by phytoplasma much prevalent and new alarming disease. Sesamum phyllody disease is transmissible by leaf hopper (*O. albicinctus*) and produces yield losses up to 34 per cent or even 100 per cent, in case of severe incidence (Sarwar and Haq, 2006). The present investigation on effect of date sowing on leaf hopper population dynamic, phyllody disease incidence and yield were revealed that, the leaf hopper population was minimum in treatment D5 (29th July), 0.53 leaf hopper per leaf with disease incidence 7.27 % and yield 811 kg/ha with respect other hand highest leaf hopper population was observed in treatment D1 (19th June) 0.77 leaf hopper per leaf, with disease incidence 12.03 percent and yield 632 kg/ha. Among the two varieties JLT-408 and Prachi maximum leaf hopper population (0.83) observed in JLT-408 with 16.58 % disease incidence and 432 kg/ha yields. The result also indicated that, sesamum phyllody disease effectively managed by late sowing (after 29th July).

Keywords: Sesamum phyllody, leaf hopper (*O. albicinctus*), phytoplasma, Sesamum and date of sowing

Evaluation of mungbean varieties against mungbean yellow mosaic virus

Sunita J. Magar, Sarode SG and S.D.Somwanshi

Department of Plant Pathology, College of Agriculture, Latur, VNMKV, Parbhani-413512

ABSTRACT

Greengram (*Vigna radiata* (L.) Wilczek) is the third most important pulse crop grown in India after chick pea and pigeon pea. It is an important short duration summer food legume in the tropical and sub-tropical countries of the world. Among all the diseases, Mungbean yellow mosaic virus (MYMV) disease is the most destructive which causes 0-100 per cent losses in yields in Indian subcontinent and adjacent areas of South-East Asia. Therefore, the present studies on varietal screening, symptomatology and electron microscopy of mungbean yellow mosaic virus disease were undertaken during Kharif-2017. Symptoms in field were irregular yellowing, chlorosis of young leaves, curling downwards or becoming papery white, puckering, reduction in leaf size, bare peduncle, bear few flower and pods turned upwards bearing few immature and small sized seeds. Electron microscopy of the purified preparation of MYMV revealed the presence of geminated particles (bipartite or pair) at different magnification. The size of virus particles measured average length of was 30-32 to 18-20 nm. Among 18 varieties screened, none was found immune and resistant. Eight (BM-4, BM-2003-2, BPMR-27, BPMR-39, BPMR-145, BPMR-148, BPMR-227, JL-781) were moderately resistant with mean disease incidence of 7- 10 percent, two (BPMR-1 and Parbhani Local) were moderately susceptible with mean disease incidence of 14-17 per cent and eight (BM-2011-3, BM-2012-7, BPMR-26, BPMR-38, BPMR-48, BPMR-55, BPMR-132, Kopergaon) were found susceptible with mean disease incidence of 36-44 per cent.

Keywords: Yellow vein mosaic virus, Screening, Whitefly, Disease incidence

Effect of date of sowing on whitefly and mungbean yellow mosaic virus

Sunita J. Magar, Sarode SG and S.D.Somwanshi

Department of Plant Pathology, College of Agriculture, Latur, VNMKV, Parbhani-413512

ABSTRACT

Greengram commonly known as mung or mungbean (*Vigna radiata* (L.) Wilczek) is an important short duration summer food legume in the tropical and sub-tropical countries of the world. Among all the diseases of mungbean, mungbean yellow mosaic virus (MYMV) is the most destructive one and it was transmitted by whitefly, *Bemisia tabaci* (Genn.) in a persistent, circulatory manner and grafting but not by sap, seed or soil (Nariani, 1960). It has potential to inflict 100% damage to mungbean crop (Nene, 1972 and Singh, 1980). The field experiment was conducted to study the influence of sowing dates on whitefly population and disease incidence of mungbean yellow mosaic virus disease revealed that the crop sown earlier (20th May) exhibited minimum mean whitefly population (0.76 whitefly/leaf), disease incidence (7.73%) and gave significantly highest yield (5.20 q/ha) while maximum mean whitefly population 1.24 and 1.11 whitefly/leaf and mean disease incidence 17.40% and 15.70% and least grain yield (3.51) and was recorded in the late sown crop 1st July and 21st June, respectively. Among the varieties, variety JL-781 recorded least whitefly population (0.84 whitefly/leaf) and disease incidence (11.59%) and gave highest grain yield (5.68 q/ha). Correlation between whitefly population and disease incidence were significant. Correlation between whitefly population and disease incidence with climatic factor was statistically significant and positively correlated with rainfall (mm), rainy days and relative humidity % (AM and PM) and negative correlated with temperature (Max. and Min.).

Keywords: Mungbean yellow mosaic virus, Whitefly, Date of Sowing, Correlations

Seasonal incidence of Chilli Aphids on Chilli

N.E.Jayewar^{1*} and B. B. Bhosale²

Department of Agricultural Entomology, College of Agriculture, Ambajogai

ABSTRACT

A field experiment to study Seasonal incidence of chilli Aphids was carried out during 2016 and 2017 with object to study seasonal incidence and population dynamics of Chilli aphids. The population of aphids found to ranged from 0.10 to 4.10 aphids/plant and 0.15 to 2.65 aphids/plant during 2016-17 and 2017-18, respectively.

During 2016-17, the nymphal and adult population was first spotted during 44th SMW (2.00 aphids/leaf) and it was continued to increase and reached its peak 11.56 aphids/plant in 50th SMW. The corresponding weather parameters were recorded as maximum and minimum temperature (29.7 and 12.7^oC), morning and evening relative humidity (74 and 30 per cent), evaporation (4.7 mm), bright sunshine hours (8.5 hrs) and wind velocity (3.9 kmph). Thereafter the population gradually decreased and sustained up to 2nd SMW.

During 2017-18, the incidence of aphids (1.20 and 9.98 aphids/plant) was noticed from end of September (39th SMW) to last fortnight of January (50th SMW). The peak incidence (9.98 aphids/plant) was observed in 50th SMW when the prevailing weather parameters were maximum and minimum temperature (31.0 and 12.5^oC), morning and evening relative humidity (78.0 and 31.0 per cent), evaporation (4.7mm), bright sunshine hours (8.6 hrs) and wind velocity (2.8 kmph). Thereafter, the aphids population fluctuated and sustained up to 4th SMW (3.28 aphids/leaf).

Keywords: Chilli, Seasonal incidence and aphids.

Seasonal incidence of Chilli mites in Marathawada

N.E.Jayewar^{1*} and B. B. Bhosale²

Department of Agricultural Entomology, College of Agriculture, Ambajogai

ABSTRACT

A field experiment to study Seasonal incidence of chilli mite was carried out during 2016 and 2017 with object to study seasonal incidence and population dynamics of Chilli mites. The data on mites population ranged between 0.40 to 6.98 and 1.42 to 8.46/leaf during 2016-17 and 2017-18, respectively.

During 2016-17, the mites population first appeared during 36th SMW (5-11 Sept.) and it was gradually increased and attained peak (6.98/leaf) during 46th SMW (14-20 Nov.) when the prevailing maximum temperature, minimum temperature, morning relative humidity, evening relative humidity, evaporation, bright sunshine hours and wind velocity were 30.3^oC, 12.1^oC, 76 per cent, 32 per cent, 4.1 mm, 9.6 hrs and 2.5 kmph, respectively. Then activity of mites was declined by the end of season i.e. 4th SMW (22-29 Jan.).

During 2017-18, the activity of mites initiated during 39th SMW (26 Sept.-02 Oct.) with gradual increase in its population and reached peak of 8.46 mites/leaf during 47th SMW (21-27 Nov.) when the prevailing maximum temperature, minimum temperature, morning relative humidity, evening relative humidity, evaporation, bright sunshine hours and wind velocity were 32^oC, 17^oC, 77.0 per cent, 42.0 per cent, 4.5 mm, 7.4 hrs and 2.4 kmph, respectively. Thereafter during 48th SMW the

3rd International Conference on “Global Initiative in Agricultural, Forestry and Applied Sciences for Food Security, Environmental Safety and Sustainable Development (GIAFAS-2021)”

population declined and again increased up to 5.96 mites/leaf in 49th SMW (5-11 Dec.). Afterwards, the population gradually decreased but sustained up to 3rd SMW (15-21 Jan).

Keywords: Chilli, Seasonal incidence and mites.

Socio-Economic profile and constraints perceived by the vegetable growers of Manipur

James W Haobijam¹, Devina Seram^{2*}, Guneshori Maisnam¹, Y L Devi¹ and Termeric Oinam¹

¹Department of Agricultural Economics and Extension; ²Department of Entomology, School of Agriculture, Lovely Professional University, Jalandhar (144411), Punjab (India)

ABSTRACT

A survey was conducted on 240 vegetable growing farmers in 12 villages of 4 blocks, from two districts (Thoubal and Bishnupur) of Manipur with an aim to study the various socio-economic profiles and constraints perceived by the farmers. In this study, purposive as well as simple random sampling techniques were used. Pre-structured interview schedule was used as the main tool for collecting data from the respondents. For studying the socio-economic status, rural constructed and scale standardized by Pareek and Trivedi was used. The scale consisted of 8 items viz. age, education, occupation, caste, family size, social participation, land and material possession. For constraints perceived by the vegetable farmers, three fundamentally isolated and related group of constraints were asked and the farmers were approached to rank them separately. The socio-economic profile of the vegetable farmers showed the following results such as majority of them were in the middle age group, studied up to high school education and following cultivation as their main occupation, in the OBC category, have a family size above 5 members, low social participation in the society, have land holdings between 1 to 5 acres and all of them possessed radio. The major economic constraint of the farmers was the non-availability of insurance at the time of natural calamity. Furthermore, the technical and the communication constraints faced by the vegetable farmers were lack of knowledge on new variety of vegetable seeds and infrequent visits from the concerned extension workers or scientists or VLWs, respectively.

Keywords: Socio-economic, constraint, rural constructed, natural calamity, communication

EFFECT OF INTEGRATED NUTRIENT MANAGEMENT ON GROWTH, YIELD AND ECONOMICS OF SWEETCORN ALONG WITH POST HARVEST NUTRIENT STATUS OF SOIL

Anjali Patel

Department of Agronomy, Indira Gandhi Agriculture University, Raipur, Chhattisgarh

ABSTRACT

Recently specialty maize (corn) such as sweet corn, baby corn and popcorn has emerged as alternate food sources, mainly for affluent society. Sweet corn (*Zea mays* L. *saccharata*) used as a human food in soft dough stage with succulent grain. The cobs are picked up at green stage (with 70% moisture) for canning and table purpose. The higher content of water soluble polysaccharide in the kernel adds texture and quality in addition to sweetness (Venkateshet al., 2003). The sweet corn is new introduction particularly as short duration crop; so, efforts are required to standardize and economize its cultivation for maximum productivity to overcome shortage and price hike of in-organic fertilizers. Therefore, such study was undertaken during kharif season of 2019-20 at the Research Farm of Raj Mohini Devi College of Agriculture & Research Station, Ambikapur (Chhattisgarh) under rain fed condition in loamy textured slightly acidic soil.

Growth attributes viz., plant height, number of leaves plant⁻¹, leaf area index, dry matter accumulation, crop growth rate were recorded at 30, 60 DAS and at harvest whereas yield attributes viz., cob length, cob girth, number of kernel row cob⁻¹, number of kernels row⁻¹, green cob and green fodder yield of sweet corn were recorded after harvesting. The treatment with 3 t ha⁻¹ vermicompost had higher growth as well as yield attributes followed by 5 t ha⁻¹ FYM and both of these treatments were proved significantly superior than the treatment without organic manure. However 100% RDF recorded higher value of such parameters and found significantly superior over 75% RDF and 50% RDF. Further the highest dehusked cob yield (14951.4 kg ha⁻¹) and net return (₹ 147265.2 ha⁻¹) was registered with vermicompost @ 3 t ha⁻¹ + 100% RDF. Different organic sources didn't cause any significant effect on post-harvest soil status viz., available N, P and K but little effect on organic carbon content but inorganic nutrient levels had significant effect on post-harvest soil status viz., available N, P and K but no effect on organic carbon. It can be concluded from one year experimentation that in sweet corn, organic manures such as vermicompost and FYM could be combined effectively with inorganic fertilizers to get higher return, benefit as well as to improve soil health.

**Evaluation of food grains for preparation of spawn for cultivation of *Calocybe indica*
Dibakar Panda^{1*} and Mohan Kumar Biswas²**

Department of Plant Pathology, Institute of Agriculture, Visva Bharati, Sriniketan-731236

ABSTRACT

Popularities of mushrooms is because of attractive texture and delicious taste, among the cultivated mushrooms milky mushroom has ability to grow in higher temperature and is also considered to be alternative of non veg foods for vegetarians. In India, some part of the country holds good promise towards the cultivation of milky mushroom, for fast growth of mycelium or easy cultivation this experiment is mainly focused on evaluation of yield and yield contributing characteristic of milky mushroom (*Calocybe indica*). Pure culture of milky mushroom procured from Tropical Mushroom Research Centre, OUAT, Bhubaneswar and was maintained on PDA medium. Different food grains for preparation of spawn viz., wheat grain (*Triticum aestivum*), paddy grain (*Oryza sativa*), bajra grain (*Pennisetum glaucum*) and sorghum grain (*Sorghum bicolor*) were used. In the present work, it is found that the spawn prepared by using bajra grain produces the average maximum yield i.e., 1340g with the biological efficiency of 134.0%.

Keywords: bajra grain, biological efficiency, *Calocybe indica*, pure culture, spawn substrates. Corresponding

Awareness and impact of Soil Health Card with reference to crop production in India

Abhinav Singh¹, Amritanshu Singh¹, Virendra Pratap¹ and Tarkeshwar²

¹Department of Extension Education; ²Department of Genetics and Plant Breeding, A.N.D.U.A.&T., Kumarganj, Ayodhya - 224 229 (U.P.)

ABSTRACT

The Soil Health Card was launched by the government of India on February 19, 2015. This scheme aims to provide farmers with the necessary nutrients and fertilizers to improve their productivity. Soil samples are collected from various locations across the country and subjected to various tests. The experts then analyse the strength and weaknesses of the soil and suggest measures to improve its health. The result and proposal will be displayed in the cards. The government plans to provide the cards to 14 crore farmers. The soil health card (SHC) is an analysis of the quality of the soil right from its functional characteristics to water and nutrient content and other biological properties. It contains corrective measure that a farmer should adopt to obtain a better yield. The SHC helps the farmers to get a well monitored report about the soil and they are guided by the expert to improve soil health.

Keywords: soil health card, farmers, crop improvement

**Study on use of Mobile phone technology by the Farmers in Balrampur District of Uttar Pradesh
Virendra Pratap^{1*}, A.K. Singh², Abhinav Singh¹ and Amritanshu Singh¹**

¹Department of Extension Education, A.N.D.U.A.&T., Kumarganj, Ayodhya -224 229 (U.P.)

²Department of Agricultural Extension, C.S.A.U.A.&T., Kanpur (U.P.)

ABSTRACT

The present study was conducted on the 110 respondents in Balrampur district of U.P. to identify use of mobile phone technology by the farmers. Out of 132 villages, 11 villages were selected randomly and 10 respondents from each village were also selected randomly for the study and thus making a total of 110 respondents. Data were collected through an interview schedule and were analyzed using simple statistical techniques like frequency, percentage. In this study finding majority of the respondent (74.54 %) were from the middle age category, having education up to high school (26.36%), and from OBC (74.54%). Further study reveals that majority of the respondents (80.90%) had large size of land holding, only farming as occupation (54.54%), medium level of income (63.64%). Tantisantisom (2011) reported that obtained agricultural information from local councils (57.2%), neighbors (56.9%) and extension workers (56.5%). Other government officers and sales agents were mentioned as a source among some villagers whereas web sites and private company showed insignificant roles as information providers which were account for less than (10%). Nearly a half of the participants (45.3%) preferred a 5-minute-information session for daily transmission, whereas another (32.1%) preferred the length of 15-minute long information sessions.

Keywords: mobile phone technology, extension education, information communication

Effect of garlic powder, Moringa oleifera leaf powder or their combination on growth performance, carcass attributes and blood biochemical parameters of broiler chickens.

Ittehad, Nazim Ali, Ahmad Fahim, D.S. Sahu, M.K. Bharti, Rajbir Singh, Debashis Roy and R.A. Siddiqui
Sardar Vallabhbhai Patel University of Agriculture and Technology, Modipuram, Meerut- 250110, India

ABSTRACT

The study aimed to investigate the effect of garlic powder, Moringa oleifera leaf powder or their combination on growth performance, carcass attributes and blood biochemical parameters of broiler chickens. 180-day-old broiler chicks were raised for 42 days in six dietary groups including Control (Basal diet), T1- Basal diet + 0.5% garlic; T2- Basal diet + 1 % garlic; T3- Basal diet + 1 % Moringa leaves; T4- Basal diet + 2% Moringa leaves and T5- Basal diet + 1% garlic + 2% Moringa leaves. The results indicated significant effect of treatments on body weight (BW) gain and feed conversion ratio (FCR) of broiler birds. Compared to treatment groups, the birds of control group consumed more feed. Significant differences ($P<0.05$) were observed in dressing yield %, thigh and wing % in treatment groups compared to control group. The liver of birds was significantly ($P<0.05$) enlarged in garlic treated groups. The blood biochemical parameters in garlic and moringa supplemented groups did not differ with the control group except lowering in the level of cholesterol. The study suggested that combination of garlic powder and Moringa oleifera leaf powder was beneficial in improving growth performance, feed utilization and carcass attributes in broiler chicken.

Keywords: Broilers, Garlic, Moringa, Phytobiotics, Supplementation

Estimation of Genotype X Environment interaction for Yield and Yield Contributing Characters in Sesame (*Sesamum indicum* L.)

Bhagwat Singh*, Rajani Bisen and Y.K. Shukla

Project Co-ordinating Unit (Sesame and Niger), JNKVV, Jabalpur (M.P.), India

ABSTRACT

An investigation was undertaken to study the “Estimation of Stability Parameter for Yield and Yield Contributing Characters in Sesame (*Sesamum indicum* L.)” to gather information on different variability parameters, genotype x environment interactions and stability parameters. The experimental material comprised of 60 different Varieties of sesame. The experiment was conducted in Randomized Complete Block Design with three replications at Project Coordinating Unit (Sesame and Niger) Research Farm, JNKVV, Jabalpur during Kharif 2016 (E1), Summer 2017 (E2), Kharif 2017 (E3) and Summer 2018 (E4). Observations on five randomly selected plants per genotype per replication in each environment were recorded for days to flower initiation, days to 50% flowering, days to maturity, flower petal colour, flower petal hairiness, plant branching pattern, plant branching habit, stem hairiness, leaf lobes, leaf size, leaf serration of margin, capsule shape, capsule arrangement, capsule hairiness, number of locules per capsule, number of capsules per leaf axil and seed coat colour. Pooled analysis of variance revealed significant mean square estimates due to genotypes for all the characters included for stability analysis. The significance of genotype x environment interaction for number of capsules per plant, number of seeds per capsule and oil content revealed differential response of the genotype to varying dates of sowing. Overall results of stability analysis indicates that genotype YLM-11 was found as stable genotype which exhibited stable performances for more than two characters, while genotypes such as N-32, SAVITRI, RAMA, RAJESHWARI, RT-351 and GT-1 exhibited above average stability for yield and yield components and therefore, these genotypes were specifically adapted to unfavorable environmental conditions.

Keywords: Sesame, stability, yield components, Genotype x Environment interaction.

Diagnostic features and distribution status of Viola species along with concurring plant taxa from Jammu Himalaya

Geeta Sharma,* Tasir Iqbal

Department of Botany, University of Jammu, Jammu

ABSTRACT

All the five studied species of Viola are herbaceous and perennial with important medicinal properties. These species of Viola have been observed to prefer moist shady slopes with gritty and well drained soils of Jammu province. *V. pilosa* was recorded from five districts followed by *V. canescens* and *V. betonicifolia* in 3 districts and *V. biflora* in 2 districts of Jammu province. *V. pilosa* has acuminate leaf, largest anterior petal and stigma with truncated beak directed downwards. In *V. canescens*, leaf tip is obtuse, anterior petal is smallest and stigmatic beak is truncated and upward directed. *V. odorata* has obtuse leaves and forwardly curved stigma. In *V. betonicifolia* the leaves are arrow head shaped, stipules are adnate with

3rd International Conference on “Global Initiative in Agricultural, Forestry and Applied Sciences for Food Security, Environmental Safety and Sustainable Development (GIAFAS-2021)”

petiole and stigma is lobed. In *V. biflorapetals* are yellow and stigma is bilobed with beaked. These features besides others can be of great help in identification of species at morphological level.

Afforestation and Development of Wasteland through Agroforestry

Kushmita Dhan, Firoz Ahmad, B.C Oraon

Silviculture and Agroforestry, Faculty of Forestry, Birsa Agricultural University, Ranchi, Jharkhand (India)

ABSTRACT

Tree growth is reported to exert an ameliorative effect on wastelands by improving their physical, chemical and biological properties. Several tree species and tree planting techniques for Agroforestry have been described, which can go a long way in greening barren undulating areas. The paper examines the possibilities of afforestation as an alternative for development of wasteland. The paper describes the use of agroforestry as a holistic approach to waste land management, and the steps in the application of agroforestry principles to waste lands. Appropriate techniques are identified as energy farms (fuel plantations and shelterbelts), silvopastoral systems, agrosilvopastoral systems with plantation crops, fish culture in dammed sites, and the use of multipurpose trees. Agroforestry has potential to contribute to restoration and conservation alongside productivity of land has been expressed in many ways, emphasizing soil conservation, land degradation, food security, land use for integrated natural resources management, or biodiversity conservation and also has played a significant role in the rehabilitation of wastelands, desert and lands degraded by salinisation, water and wind erosion. Wise management of Agroforestry puts forward a suitable substitute to control deteriorated asserts to increase yield and to protect environment. Providing vegetative cover to such lands with woody and herbaceous species can put these lands to optimal use and also increase the forest cover of the country. Yield potential of these degraded lands is quite low and these lands are best suited for silvopastoral and other tree-based system.

Keywords: Afforestation, Agroforestry, Forest, Wasteland.

Biodiversity of Predatory Coccinellid Beetles (Coccinellidae: Coleoptera) from agricultural ecosystem of Garhwal region of Uttarakhand, India

Pushpendra K. Sharma

Department of Zoology, D.A.V. (P.G.) College, Dehradun (U.K.), India

ABSTRACT

The insects of family Coccinellidae are commonly known variously as ladybirds (English English, Australian English, and South African English), ladybugs (North American English), lady beetles or coccinellid beetles (preferred by scientists). The family name comes from its type genus, Coccinella. The family Coccinellidae comprises 5,200 described species worldwide. Most of them are of bright shining colors with a pattern of spots or patches against a contrasting background. These beetles are of extremely diverse habits. The majority of beetles are useful because of their predaceous nature; but some are harmful, being polyphagous. The other coccinellids are predators of a variety of pests viz., aphids, leaf-hoppers, scale insects, mealybugs, mites and other soft-bodied insects. Some are specific in their food choice, while many are polyphagous.

An extensive survey of predatory Coccinellid beetles (Coleoptera: Coccinellidae) was conducted in the agricultural areas of Garhwal region of Uttarakhand, India, over a period of fifteen years (July 2005 to June 2020). A total of 32 species of Coccinellids were collected from different study sites representing agricultural ecosystems. Out of these 32 species, 28 species were identified as predatory coccinellids, while 04 species were identified as phytophagous. The dominant species are *Coccinella septempunctata* Linn., *Coccinella transversalis* (Fabricius), *Cheilomenes sexmaculata* (Fabricius), *Anegleis cardoni* (Weise), *Harmonia dimidiata* (Fabricius), *Hippodamia variegata* (Goeze), *Hippodamia* sp., *Illeis cincta* (Fabricius), *Megalocaria dilatata* (Fabricius), *Micraspis discolor* (Fabricius), *Micraspis vincta* (Fabricius), *Micraspis* sp., and *Psyllobora bisoctonata* (Mulsant). The presence of 32 species of coccinellid beetles in agricultural areas suggests that Garhwal region have diverse and rich fauna of coccinellid beetles. A clear gradation in the species composition of coccinellid beetles along the altitudes was quite evident.

Managing diseases of Mango

Archana Kushwaha¹, Jitendra Chandra Chandola² and Vijay Kumar²

¹ *Department of Plant Pathology, College of Agriculture, G.B. Pant University of Agriculture and Technology, Pantnagar-263145 (U.S. Nagar), Uttarakhand, India.*

² *Krishi Vigyan Kendra, Saran-841313, Dr. Rajendra Prasad Central Agricultural University, Pusa, Bihar*

ABSTRACT

3rd International Conference on “Global Initiative in Agricultural, Forestry and Applied Sciences for Food Security, Environmental Safety and Sustainable Development (GIAFAS-2021)”

Among the fruit grown in this country, mango (*Mangifera indica* L.) enjoys the place, pride and predominance by virtue of its adaptability to diverse soil and climatic conditions, wide range delicious taste, flavor, very high nutritive and medicinal value as well as great religious historical significance, it has enviable honour of being called the “King of the Fruits”. Mango is affected by a wide variety of diseases incited by fungi, bacteria, nematodes, alga as well as several non-parasitic causes. Powdery mildew caused by *Oidium mangifera* results into wide spread destruction. The disease can be easily managed by giving three sprays of Karathane (0.1%) or wettable Sulphur (0.25%) starting from pre flowering stage till fruit set. Anthracnose caused by *Collectotricum gleosporioides* affects the tree at different stages. The disease results into loss vigour, pre-mature leaf fall and fruit rot. The disease can be easily managed by the periodical sprays with Bordeaux mixture (0.8%), Captaf (0.3%), Dithane Z-78 (0.3%). Dipping fruits in benomyl (500ppm) and thiabendazole (900ppm) can check poor harvest rot. Dieback caused by *Botryodiplodia theobromae* results into death of actively growing branches. Macrophoma rot is primarily a disease of young nursery plants in which large, irregular, brown necrotic patches are produced on the leaves and elongated or elliptical lesions appear on the stems. Grey blight incited by *Pestalotiopsis mangiferae* mainly affects leaves and the disease is more severe during winter months. Sooty mould caused by a number of non-pathogenic fungi forms a black peppery growth on the surface of the leaves, bark of the shoots and skin of the fruits. All the diseases can be controlled by the fungicides used against anthracnose. Bacterial canker or leaf spot also results into premature leaf fall and twig blight. Red rust and black tips are very serious in certain specific locations.

Keywords: Diseases, management, predominance, non-parasitic, non-pathogenic, fungicides.

Comparative efficiency of nano-mineral on growth performance, blood biochemical and carcass characteristics in commercial broiler production

Najeebullah Azizi, Nazim Ali, Debashis Roy, Ahmad Fahim, D.S. Sahu, Rajbir Singh and R.A. Siddiqui

Sardar Vallabhbhai Patel University of Agriculture and Technology, Modipuram, Meerut- 250110, India

ABSTRACT

The study aimed to study the effects of different inclusion levels of supplementary Zinc oxide and nano-zinc on the growth performance, blood-biochemical and carcass characteristics of broiler chickens. 200 day-old Cobb 400 chicks were divided into 5 treatment groups comprising of 4 replicates containing ten birds in each replicate. T₁ group of bird was fed with basal or control diet. T₂ group was given basal diet along with supplementation of inorganic Zn @ 80 ppm of basal diet. T₃, T₄ and T₅ groups of birds were fed with basal diet with supplementation of zinc nano particles @ 60 ppm, @ 80 ppm and @100 ppm of basal diet. It was observed that zinc supplementation improved the average body weight of birds in all the treated groups. T₄ and T₅ groups of birds showed the highest body weight in all the weeks. Body weight gain was found higher in nano-Zn supplemented groups than both control and inorganic Zn supplemented group. FCR in nano-Zn supplemented groups were significantly lower than control up to 5th weeks of age. Thus feed efficiency was improved by supplementing nano Zn. FCR was found economical up to 4th week of age. Blood biochemical parameters like total serum protein, uric acid, cholesterol, ALP, SGOT and SGPT were found to be within normal range. The carcass traits showed that dressing % remained similar in all the treatment groups, although, thigh, back, neck and wing % varied significantly (P<0.05) among different treatment groups. For internal organs, it was found that heart, liver and proventriculus wt. % varied significantly among treatment groups. It was concluded that supplementations of zinc nano particles up to the level of 100 ppm of feed improved the growth performance and feed utilization in commercial broiler without affecting blood biochemical and carcass quality traits.

Keywords: Broilers, FCR, Nano-zinc, Supplementation

A Study on different flower extracts sprays in attraction of natural enemies in cabbage crop ecosystem

M. Sreedhar^{*1}, Sunil Dutt Pant¹, Dr. R. P. Maurya¹ and A. Vasudha²

¹*Department of Entomology, College of Agriculture, G. B. Pant University of Agriculture and Technology, Pantnagar-263145 (Uttarakhand).*

²*Department of Entomology, Agrl. College & Res. Instt, Tamil Nadu Agriculture University, Coimbatore-641003 (Tamil Nadu).*

ABSTRACT

A Study on different flower extracts sprays in attraction of natural enemies in cabbage ecosystem was conducted in December, 2020 to January, 2021 in the Norman E. Borlaug Crop Research Centre (NEBCRC), G.B.P.U.A&T, Pantnagar. Flowering plant species, such as 1. Golden shower (*Cassia fistula*) 2. Tomato (*Solanum lycopersicum*) 3. Chili pepper (*Fuchsia splendens*) 4. Mustard (*Brassica juncea*) 5. Chrysanthemum (*Chrysanthemum indicum*) 6. Marigold (*Tagetes erecta*) and water used as control in this experiment. Results of experiment showed that highest coccinellids were noticed in mustard

3rd International Conference on “Global Initiative in Agricultural, Forestry and Applied Sciences for Food Security, Environmental Safety and Sustainable Development (GIAFAS-2021)”

flower extract (1.62) spray field followed by golden shower (1.38), chili pepper (1.13) and marigold (1.13) compared to control (1.0) on 1 DAS. Non-significant results were observed in 3 DAS, 5 DAS, 7 DAS and 10 DAS. The attraction of parasitoids (Braconidae and Aphelinidae) to specific flower extract spray decreased with increase in days after spraying. The highest increase in Braconidae and Aphelinidae was observed in Chrysanthemum (3.98, 3.60, 3.21, 2.76 and 2.22) and (3.70, 3.31, 3.11, 2.58 and 2.00) on 1, 3, 5, 7 and 10 DAS, respectively. The lowest increase in Braconidae and Aphelinidae was found to be 1 DAS (Golden shower, 3.31 and 2.95), 3 DAS (Tomato, 2.66 and chilli pepper, 2.24), 5 DAS (Chili pepper, 1.90 and 1.61), 7 DAS (Golden shower, 2.07 and 1.72) and 10 DAS (Golden shower, 1.52 and mustard 1.14). Non-significant results were observed in spiders, syrphids and myrid bugs to be 1, 3, 5, 7 and 10 DAS. This is a first of its kind research. This study provides information on aqueous flower extracts and their impact on natural enemies in cabbage ecosystem as it may be useful to future proceedings.

Keywords: Aqueous flower extracts, golden shower, tomato, chilli pepper, marigold, coccinellids, parasitoids

Evaluation of botanicals and bioagents for the management of early blight disease of tomato

Pooja Sangwan*, Rakesh Sangwan, Vinod Kumar Malik, Manjeet Singh and M.S. Bochalya

Department of Plant Pathology, CCS Haryana Agricultural University Hisar, Pin 125 004 (Haryana) INDIA

ABSTRACT

Tomato belonging to family Solanaceae is most popular vegetable crop grown throughout the world and rank second in importance. The tomato crop is affected by many diseases caused by fungi, bacteria, viruses and nematodes. Among fungal diseases, early blight disease caused by *Alternaria solani* is one of the most destructive disease of tomato. The disease is air borne and soil inhabiting in nature. The present investigation was carried out to study the effect of suitable botanical and bioagent against early blight disease. The efficacy of three botanicals viz., *Clerodendron* leaf extract @ 20%, *Bougainvillea* leaf extract @ 20%, Ginger rhizome extract @ 20% and three bioagents *Trichoderma harzianum* @ 1×10^8 spores/ml, *Trichoderma viride* @ 1×10^8 spores/ml and *Pseudomonas* spp. @ 1×10^8 cfu: WG @ 0.1% were tested against early blight disease under field conditions. The observations on per cent disease intensity and yield per hectare was recorded. Among the tested botanicals and bioagents, minimum disease intensity (33%) was recorded in treatment with *Trichoderma harzianum* @ 1×10^8 spores/ml followed by *Clerodendron* leaf extract @ 20% (36.33%) and *Trichoderma viride* @ 1×10^8 spores/ml (36.67 %) as compared to control (47.33%). Higher yield of tomato was achieved in case of treatment with *Trichoderma harzianum*. Hence, *Trichoderma harzianum* @ 1×10^8 spores/ml was found promising in managing the early blight disease and is eco-friendly approach.

Evaluation of fungicides for the management of early blight disease of tomato

Pooja Sangwan*, Vinod Kumar Malik, Rakesh Sangwan, Manjeet Singh and M.S. Bochalya

Department of Plant Pathology, CCS Haryana Agricultural University Hisar, Pin 125 004 (Haryana) INDIA

ABSTRACT

Tomato is most popular and widely grown vegetable crop throughout the world. The crop is affected by many biotic and abiotic stresses. Among biotic stresses, early blight disease caused by *Alternaria solani* is one of the most destructive disease of tomato. The present investigation was carried out to study the efficacy of fungicides for managing early blight disease. The five fungicides: Kitazin 48% EC @ (0.20%), Azoxystrobin 23% @ 500ml/ha, Azoxystrobin 18.2% + difenoconazole 11.4% @ (0.05%), Tebuconazole @ 50% + Trifloxystrobin 25% WG @ 350g/ha and Mancozeb 75% WG @ 0.1% were used and first spray was given at the initial appearance of the disease followed by one more spray at fifteen days interval. The observations on per cent disease intensity and yield per hectare was recorded. Among the tested chemicals, minimum disease intensity (24.00%) was found in foliar spray with Azoxystrobin 23% @ 500ml/ha followed by Tebuconazole @ 50% + Trifloxystrobin 25% WG @ 350g/ha (27.33%). Maximum yield (37.14 q/ha) was also achieved in treatment Azoxystrobin 23% @ 500ml/ha. Hence, Azoxystrobin 23% can be used for controlling early blight disease of tomato

Conservation and commercialization of hill stream fish, *Garra gotyla gotyla* (Gray 1830) through Induced breeding

Preeti Bhatt^{1*}, R.S. Patiyal¹, B.C. Pathak²

¹ICAR- Directorate of Coldwater Fisheries Research, Bhimtal, 263136, Uttarakhand, India

²Department of Zoology, L.S.M. P.G. College Pithoragarh, 263002, Kumaon University, Nainital, Uttarakhand

ABSTRACT

Garra gotyla gotyla is hill stream indigenous fish of Uttarakhand known as stone lapping minnow. Genus *Garra* found in Asia and Africa including India, Pakistan, Myanmar (Getahun and Stiassny, 1998; Degbudze & Mina, 2002). It is one of the

3rd International Conference on “Global Initiative in Agricultural, Forestry and Applied Sciences for Food Security, Environmental Safety and Sustainable Development (GIAFAS-2021)”

popular food fish as well as ornamental fish with its aqua cleaner excellence. Both quality, the bizarre appearance and taste of fish makes it candidate species in aquaculture system. *Garra gotyla gotyla* is an annual spawner, Laying egg in sandy and gravel substrate of stream. But during the study it has been observed that the wild population of this species is declining in their breeding ground. For conservation and commercialization of *Garra gotyla gotyla* as food fish as well as ornamental fish require mass scale production of fish.

Induced breeding helpful to reimburse, maintain and increase the production in fisheries sector. This study is carried out to understand the Induced breeding strategy of fish. Few attempts have been done on induced breeding and rearing of *Garra gotyla gotyla* in aquaculture system. For this study Brooders were collected from river Kosi and west Ramganga during May – June 2021 and reared in DCFR- Bhimtal. Spawning period of sexually matured Fish is September. Matured Female is identified through a bulging abdomen and Male is identified by prominent tubercles on the snout. For induced breeding the female and male taken in 1:2 ratio. After ejecting ovatide both male and female were released in spawning hapa at the optimum temperature of 18.5 – 21.4°C. Spawning was done after 9.30 hour of ejecting ova tide dose. The fertilization rate is 78%. Survival rate from fry to fingerling is more than 92%. Strategy for Mass scale production will be a successful step for commercialization of this precious species. This study will also helpful to conserve the fish in their natural habitat through ranching and improve the status of fish in ornamental sector.

Keywords: Induced breeding, Spawning, Ranching, Ornament, survival rate.

Climate Change modeling and projections for Agriculture in Chhattisgarh

Alok Kumar Chandrakar

Department of Forestry, Wildlife & Environmental Sciences Guru Ghasidas Vishwavidyalaya, Bilaspur, Chhattisgarh

ABSTRACT

Agriculture represents a core part of the Indian economy and provides food and livelihood activities to much of the Indian population. It represents 35% of India’s Gross National Product (GNP) and as such plays a crucial role in the country’s development. The impact of climate change on agriculture could result in problems with food security and may threaten the livelihood activities upon which much of the population depends. Climate change can affect crop yields (both positively and negatively), as well as the types of crops that can be grown in certain areas, by impacting agricultural inputs such as water for irrigation, amounts of solar radiation that affect plant growth, as well as the prevalence of pests.

This paper explores some aspects of the impact of climate variability and projected changes in the mean values of temperature and precipitation at the regional level for India. There are significant uncertainties in predicting changes in rainfall patterns for India, particularly because of difficulties in understanding and predicting monsoon behaviour. More robust results are available regarding future rises in temperature expected in the Indian subcontinent. While the dependence of Indian agriculture on rainfall is well-known, the significance of increased temperature variability must also be considered. A variety of crop growth models were used to evaluate potential climate change impacts on wheat and rice (India’s primary crops), and other crops such as sorghum and maize. Specific variables used in the models included changes in temperature, CO₂ levels, precipitation, and solar radiation. Importantly, these variables can both increase and decrease crop yields with changes in climate, and therefore the interaction of these effects was also studied. The study also examined impacts on rain-fed versus irrigated crops. The models were developed using historic weather datasets as a baseline, correlated with growth and yield of crops to characterize inter-seasonal climatic variability at various locations.

Keywords: Climate change, regional climate variability, agriculture, crop growth model.

Sheath blight (*Rhizoctonia solani*) a serious threat for rice cultivation

Mahaveer Singh Bochalya*¹, Vipul, Manjeet Singh, Vinod kumar Malik and Pooja sangwan

Department of Plant Pathology,RRS, Kual, CCS HAU, Hisar-125004

ABSTRACT

Rice is an important food grain and is a staple food for majority of the world’s population. To meet out increasing global demand and consumption, rice productivity must be enhanced. However, biotic stresses such as diseases have impeded rice cultivation both in the tropics and subtropics. Among them, sheath blight is a major soil borne disease causing economic losses to rice cultivation. Sheath blight of rice caused by *Rhizoctonia solani* Kuhn [teleomorph: *Thanatephorus cucumeris* (Frank) Donk] is of worldwide occurrence and is known to cause substantial yield losses. It is a major production constraint in high yielding varieties under intensive rice production systems. The pathogen has a very wide host range and exhibits considerable pathogenic and molecular variability. Due to non-availability of resistant cultivars, the management of sheath blight primarily relies on chemical control. However, the disease can be managed effectively through integration of effective cultural practices, botanical pesticides, bio-control agents and fungitoxicants. Since there is non-availability of resistant cultivar against sheath blight of rice so a lot of research is taking place in this field. The endochitinase (cht42) gene from the

3rd International Conference on “Global Initiative in Agricultural, Forestry and Applied Sciences for Food Security, Environmental Safety and Sustainable Development (GIAFAS-2021)”

mycoparasitic fungus, *Trichoderma virens*, was introduced into rice by *Agrobacterium*-mediated transformation. Infection assays performed on the homozygous transgenic t2 generation plants with *Rhizoctonia solani* showed up to 62% reduction in the sheath blight disease index. During the past two decades, a wide variety of genes and mechanisms involved in rice defense response have been identified and elucidated. However, most of the cloned genes confer high level of race specific resistance in a gene for gene manner and the resistance is effective against one or a few related races or strains of the pathogens which is effective for only few years because the pathogen race or strain keeps changing for survival in nature. Therefore, there is an urgent need to broaden the rice gene pool from diverse resources, of which the wild rice is an ideal option.

Keywords: Sheath blight, Rice, Resistant cultivars, Endochitinase

Leaf Blast of rice, a hurdle in export of basmati rice

Mahaveer Singh Bochalya*¹, Vipul, Manjeet Singh, Vinod kumar Malik and Pooja sangwan

Department of Plant Pathology,RRS, Kual, CCS HAU, Hisar-125004

ABSTRACT

Rice is an important food grain and is a staple food for majority of the world's population. To meet increasing global demand and consumption, rice productivity must be enhanced. However, biotic stresses such as diseases have impeded rice cultivation both in the tropics and subtropics. Among the diseases caused by fungi, rice blast *Pyricularia oryzae* appeared as most destructive diseases from seedling stage to grain formation causing leaf, node, neck and panicle blast symptom. Losses due to rice blast can be greater than 50 per cent when it comes in epidemic form. Traditional method adopted to control this disease largely depends upon use of chemical fungicides. There are many studies which shows efficacy of different fungicides against rice blast disease. In some studies tricyclazole found most effective, but there is problem of tricyclazole pesticide residue in the rice grains. Farmers use these pesticides very late (after the grain formation stage) in the rice crop. It leads to the residues of pesticides beyond the permissible maximum residue limit (MRL) in the grains after harvesting of the crop. Since basmati rice is exported so our government give emphasis on its pesticide residual level. The European Union had cut the maximum residue limit (MRL) for Tricyclazole from 1 PPM to 0.01 PPM from December 31, 2017. Reduction in the use of chemical pesticide in agriculture is highly desirable. So, Integrated Pest Management (IPM) has been introduced as the best alternative for pest management in rice. The disease can also be managed effectively through integration of effective cultural practices, botanical pesticides, bio-control agents and fungitoxicants. Apart from this by using classical plant breeding techniques, breeders have developed a number of blast resistant cultivars adapted to different rice growing regions worldwide. However, the rice industry remains threatened by blast disease due to the instability of blast fungus. The best way for controlling the disease is to incorporate both qualitative and quantitative genes in resistant variety. Many researchers have demonstrated that applying silicon to the soil causes higher silicon levels in rice and, as a consequence, an increase in blast resistance.

Keywords: Rice, Blast, Tricyclazole, Integrated pest management

Defense signaling mechanism in plants against micro-creatures

Mahaveer Singh Bochalya*¹, Vinod kumar Malik, Pooja sangwan and Manjeet Singh

Department of Plant Pathology,RRS, Kual, CCS HAU, Hisar-125004

ABSTRACT

Plants have to cope with various forms of stress stimuli and these include biotic and abiotic stresses. Plants have innate immunity system (Robinson and Bostock, 2015) and this powerful weapon provides protective functions against wide range of plant pathogens by activating a multicomponent defense resistance nature of plants based on timely recognition of pathogen molecular patterns viz., MAMPs/PAMPs/WAMPs and avirulent (Avr) gene products with the pattern recognition receptors (PRRs) and resistance genes (Sharma and Gupta, 2020). The activation of local defense responses further induces the production of long-distance defense signals to activate systemic acquired resistance (Sun and Zhang, 2021). The active recognition results in triggering the induction of defense mechanism via a complex signalling network, involving change in redox status, inorganic ion fluxes (Ca^{2+} and H^+), reactive oxygen intermediates, MAP Kinases, Nitric oxide (NO), Salicylic acid, Jasmonate. SA signaling system triggers resistance against *Xanthomonas oryzae* pv. *oryzae* in rice (Xu et al., 2013). Phytohormones such as ethylene (ET), abscisic acid (ABA), auxin, gibberellins (GAs), cytokinins (CKs) and brassinosteroids (BRs) are also involved in defense responses (Berens et al., 2017). Defense genes encode Pathogenesis related proteins, phytoalexins, antimicrobial peptides, lipid transfer proteins, enzymes involved in oxidative stress protection, tissue repair, lignification etc. Plant disease Resistance genes (R) provide resistance against wide range of pathogen by producing R proteins and will also be of great relevance for their use in development of transgenics. RNA silencing mechanisms have recently been shown to be required for R gene-mediated defense in viruses (Moon and Park, 2016). There is enhanced disease resistance in transgenic rice plants by introgression of defense related R genes i.e. Pi5, Pi36,

3rd International Conference on “Global Initiative in Agricultural, Forestry and Applied Sciences for Food Security, Environmental Safety and Sustainable Development (GIAFAS-2021)”

Pi37, Pigm, Pi54, Pid3, Pit, Pb1, Pikm against *Magnoportha oryzae* (Jiang et al. 2019). Bioengineering PRRs and PIMPs have been shown to be another potential technology to awaken the quiescent plant innate immunity for effective management of crop diseases. Therefore, studies on understanding the concept of basal and inducible plant immune system will be helpful to identify key components that could be used to design novel strategies that will ultimately secure plant against the pathogen attack.

Keywords: Defence mechanism, Avirulent gene, Pathogenesis related protein, Phytoalexins

Prospects of remote sensing in assessing soil health

Ritambhara

ICAR-IARI, New Delhi, 110012

ABSTRACT

Soil is the basic requirement of life on earth. A healthy soil is necessary in order to maintain the functions of soil to its optimum and keep feeding and sustaining the burgeoning population. Soil health assessment is done in order to see how well the soil is performing its functions and for the same purpose measurement of multiple chemical, physical and biological soil properties, referred to as soil health indicators is needed (Moebius-Clune et al., 2016). Quantifying the soil properties is crucial as they are directly involved in quantifying soil health. Conventionally soil sampling and laboratory analysis are time consuming, costly and limited in retrieving spatial and temporal variability of soil properties. In this context remote sensing (RS) has potential to rapidly, repeatedly and inexpensively assess soil properties at various scales working on principle of electromagnetic waves and spectral signatures. Remote sensing, despite of many shortcomings is emerging as a cheaper, robust tool to assess soil health by measuring and mapping soil properties at regional as well as global scales. So, I have collected literature for worldwide location studies published under eminent publications. Airborne acquisition of multispectral and hyperspectral imaging spectroscopy is providing necessary data to map soil properties in an efficient and rapid manner. Vohland et al., (2017) in research conducted in Germany showed good prediction of organic carbon (RPD = 2.20) and microbial biomass carbon (RPD=2.35) through remote sensing. A good prediction was shown with airborne hyperspectral imagery for 15 out of selected 19 analytes (C, sand, silt, clay, pH, OM, K, Ca, Mg, Mn, Zn, Fe, Al content) with $R^2 > 0.5$ (Hively et al., 2011). Unmanned aerial vehicle like drones mounted with sensor too predicted soil properties with a hopeful accuracy like organic matter with $R^2 = 0.48$ (Angelopoulou et al., 2019) and pH (Jack et al., 2019). Spaceborne imaging spectroscopy has also shown promising results for soil properties mapping and estimation as shown by some research studies like spatial SOC prediction (Mondal et al., 2016), soil texture estimation using Radar and Optical data (Bousbih et al., 2019) and spatial distribution of soil alkalinity and salinity (Bai et al., 2016). With the upcoming availability of next generation of high-quality orbiting imaging sensors, a major step towards improved accuracy of quantitative soil maps is expected at regional and global level (Steinberg et al., 2016).

Shortcomings:

Only bare soil pixels are analyzed generally: it is observed in a lot of studies conducted by the many scientists that bare pixels are only well analyzed and vegetation as well as tillage or any other covering of the surface like mulching causes hindrance and pixels cannot be well interpreted. This is why it is an issue in an era where conservation agriculture practice is being much popularized. Reflectance at shorter wavelengths is strongly affected by atmospheric scattering and absorption causing low detected signal/noise ratio: it is also a big issue with regard to accuracy and clear interpretation and because of atmospheric interference many of the absorption spectra get distorted causing trouble in clear interpretation. Not many soil attributes contributing significant to soil health index are quantitatively estimated directly with a considerable accuracy: a big issue is this concern that we are not able to quantify exactly not many of the soil properties which contribute in soil health index. Reflectance among different spectral bands is highly inter-related. At low contents remote sensing fails to predict accuracy of the attributes.

Conclusion:

Based on the abovementioned studies it can be concluded that remote sensing technology offers the potential to rapidly, repeatedly and inexpensively assess soil health at various scales as depicted by the various studies. Using hyperspectral data includes various complex statistical models which are very complicated to understand as well as apply, so some easier solution should be thought.

Future Thrust:

Very limited scientific studies are done using combination of sensors. So, more work can be done with combination of sensors like optical sensors with radar to improve predictions and accuracies of soil attributes. More advanced techniques can be evolved to improve predictive power of models. Simpler algorithms should be evolved which are easier to parametrize. Image processing techniques should be more advanced so as to get higher information from spectroscopic imageries. Sub-surface property determination models should also be worked on further.

Citronella plants can be a valuable choice for biological management of invasive Eupatorium adenophorum

Sonam Rawat*, Monali Chauhan, Pallavi sati, Sudeep Chandra, M.C. Nautiyal

High Altitude Plant Physiology Research Center, HNB Garhwal University Srinagar

ABSTRACT

Biological invasion of weeds is a big threat to agriculture and ecosystem, challenging global food security. Chemical and mechanical approaches to weed management have adverse effects on the ecosystem, viz damage to native flora, soil erosion. Biological management of weeds through allelopathic activity can be a valuable choice to minimize the weed invasion. Hence the present study aims to manage an invasive weed Eupatorium adenophorum Spreng using environmentally friendly approaches. Cymbopogon nardus L. was selected for intercropping with E. adenophorum, two kinds of approaches were followed: - 1st was to find out the effect of different concentrations of powdered crude material of E. adenophorum on the growth and biochemistry of C. nardus, the 2nd approach was planting both E. adenophorum and C. nardus together to find out the allelopathic interaction in the field conditions. The soil rich with higher concentration of E. adenophorum crude powder influence the growth and biochemistry of C. nardus, concentration till 5% found suitable for plant growth and also showed higher value of Total Phenolic Content (TPC), Total Soluble Sugars (TSS). In field study all the the Leaf area, number of leaves, TPC and TSS of C. nardus showed negative correlation with morphological and biochemical parameters of E. adenophorum. The survival of C. nardus in the E. adenophorum farruginous soil, and inhibition of E. adenophorum intercropped with C. nardus are key finding of our study. The present study suggested that plantation of C. nardus can be a valuable choice (due to commercial value in pharmaceutical and essential oil industries) at the places which are already invaded by E. adenophorum.

Keywords: Allelopathy, Weed management, Sustainability

A study on Effectiveness of ICT Module on Dissemination of Knowledge among Dairy Farm women

Geeta Channal and ** Rekha Rayanagoudar

All India Co-ordinated Research Project- Home Science Extension, University of Agricultural Sciences, Dharwad

ABSTRACT

In India, the livestock production and agriculture are intrinsically linked, each one being dependent on the other and both are crucial for the overall food security. Livestock has considerable potential for generating additional income as well as employment through various sectors and one among them is dairy farming. Dairy sector plays a significant role in supplementing family income and generating employment in the rural areas particularly among the landless, small and marginal farmers and farmwomen, besides providing nutritious food to millions of people. Hence dairying is considered to be a powerful instrument of social and economic change by the planners and policy makers. The present study aims to analyze the effectiveness of ICT module in terms of knowledge gain among exposed dairy farm women. ICT module on Scientific Dairy management practices was developed in consultation with experts and subject matter specialists from the field concern by giving due importance to the dairy farmers need. The module consists of print (Booklet, Flash cards) and audio visual (video) material. This module was used to educate 60 dairy farm women from Sulla and Jeerigwad villages of Dharwad District. The data was collected before and after intervention with the educational package. Dairy farm women were exposed to measure the knowledge gain. Knowledge scores were assessed at pre and post-exposure stages. The results of the study revealed that, there was significant difference with respect to knowledge gain among dairy farm women in relation to scientific dairy farming practices viz, Cattle shed management, Fodder crops, Enrichment of fodder crops, Fodder conservation & Clean milk production, The results of the study clearly indicate that majority of the farm women perceived memory card as most effective (80%) & there was a significant and positive association between age of the respondents and cattle shed management and clean milk production..

Keywords: ICT, Module, Dairy, Farm Women

Prevalance Of Bacterial Contamination and Antibiotic Susceptibility in River Ganga At Rishikesh And Hardwar .

Sangeeta Madan and Deepika Sharma

Department of Environmental Science, Kanya Gurukul Campus, Gurukul Kangri(Deemed to be university) ,Haridwar

ABSTRACT

Surface water pollution is a matter of serious concern nowadays. The increasing pathogenic pollution of surface water is alarming as it poses major health risks, disease outbreaks, and menacing the water supply for domestic, recreational, and for

3rd International Conference on “Global Initiative in Agricultural, Forestry and Applied Sciences for Food Security, Environmental Safety and Sustainable Development (GIAFAS-2021)”

other purposes. Spreading of multiple antibiotic resistance among bacteria in Ganga River is a threat to the entire Indoganggetic plains. Several studies showed the instance of multiple antibiotic-resistant bacterial communities in lower stretches, several fragmentary reports are also available in upper stretches but not seasonally thus the current investigation was done to assess the bacterial contamination and antibiotic-resistant patterns seasonally at the most religiotouristic pilgrimage sites Rishikesh and Haridwar constituting upper Ganga stretch. The results revealed the remarkable presence of bacterial load, indicator coliforms, and the prevalence of multiple drug resistance among the bacterial communities.

Keywords: water pollution, pathogenic, antibiotic, contamination, bacterial load

Organic pollutants in waste water and its remediation approaches using graphene adsorbent **Krishna Rawat**

SESD, Central University of Gujarat, Gandhinagar, Gujarat

ABSTRACT

Release of contaminants/pollutants in environment above permissible limits has been a matter of concern since past. They are prime source for environment pollution and causing health issues to general public and other living creatures. In same series organic pollutants are serious concern to surrounding site of release, among them persistent organic pollutants are more threaten to our environment. Organic pollutants contaminate the surrounding where they are released, thus their remediation is of prime importance to save our environmental and assure health to living being. Therefore this paper attempts to bring forward the organic pollutants in wastewater and highlights the possible remediation approaches that can be adopted to assure healthy environment.

Keywords: Organic pollutants, contamination, remediation, persistent organic pollutants.

Forest Fire and its influence on environmental conditions: A review

Rajesh Kumar¹, Harischandra Darro², Atul Kumar Bhardwaj³, K. K. Chandra⁴

^{1, 3 & 4}Department of Forestry, Wildlife & Environmental Science, Guru Ghasidas (A Central University) Vishwavidyalaya, Bilaspur (Chhattisgarh)

²Department of Forestry, Indira Gandhi Krishi Vishwavidyalaya, Raipur (Chhattisgarh)

ABSTRACT

Currently, a forest fire is a core issue of forest deterioration and ecosystem services across the globe. The world forest faces extreme fire that degrades a large area of the forest result loss in the ecosystem and biodiversity. Most of the fire incidences occur because of the increasing activities of the human in a forest area. Intentionally, forest residents and tribal communities set fire for collecting forest produces and cultivating agriculture in the forest area. The recurrent fire contributes to global greenhouse gases, which accelerating climate change. Major gases emitted with forest fire includes carbon dioxide, nitrogen oxides, volatile organic carbon, and particle matters. These gasses reduce the efficiency of ozone and release the aerosol into the atmosphere, which complex affects the cooling and warming dynamics of the environment. Worldwide, there have been increasing incidences of forest fire for few decades results in environmental, economical, and ecological losses to natural resources.

Keywords: Forest, Fire, Ecosystem, Environment, Climate change.

Antagonistic performance of Trichoderma spp. against Colletotrichum falcatum causing red rot in sugarcane

*** Jayant Mandal/ Anwar Ahmad / Dr. Sujeet Pratap Singh/ Dr. Ajay kumar.**

Uttar Pradesh Council of Sugarcane Research- Shahjahanpur.

**Chaudhary Charan Singh University –Meerut.*

ABSTRACT

Sugarcane is an oldest crop known to man a major crop of tropical and sub tropical region worldwide. Plant disease caused by various fungi may cause significant losses of sugar and alcohol (bio-fuel). Red rot (*Colletotrichum falcatum*) is one of the most dreaded diseases of sugarcane, called "cancer of sugarcane" as it has become major constraint in the profitable cultivation of sugarcane. The disease is mainly managed with resistant genotypes but breakdown of resistance with new pathotype is a recurring problem for red rot management. The present study was conducted in the laboratory. Efficacy of *Trichoderma* against *C. falcatum* was tested in in vitro condition. Three species of *Trichoderma* such as *T. harzianum*, *T. viride* and *T. virens* were obtained from Soil microbiology division. *C. falcatum* was isolated from infected cane of red rot. *Trichoderma* isolates against *C. falcatum* was assessed by dual culture technique on OMA medium. Observations of

3rd International Conference on “Global Initiative in Agricultural, Forestry and Applied Sciences for Food Security, Environmental Safety and Sustainable Development (GIAFAS-2021)”

inhibition of mycelial growth and sporulation of the pathogen were recorded on seventh day after inoculation of *Trichoderma* isolates. *Trichoderma* cultures were placed at the opposite end of the Petri dish on OMA. The antagonistic effect of *Trichoderma* was assessed on the basis of pathogen mycelial inhibition on seventh day at 28±2°C. *Trichoderma* isolates were cultured along with *Colletotrichum falcatum* in petriplates for a week and it was found that all the species of *Trichoderma* reduced the mycelial growth of *Colletotrichum falcatum*. Results indicate that all the fungal antagonists inhibited the growth of *C. falcatum*. *Trichoderma harzianum* gave best result in dual culture with minimum radial growth of 10.23 mm and maximum growth inhibition of 88.63% followed by *T.virens* with radial growth of 19.7 mm and growth inhibition of 78.11%, *T.viride* with 21.3 mm growth and 76.30% inhibition. *T. harzianum* antagonists could be use a biocontrol mechanism against *C. falcatum*.

Recycling of Organic Wastes: A Promising Alternative to Augment Soil Fertility

Ritika Gupta^{1*}, Dr. Narinder Panotra², Jyoti Sharma³

^{1,2,3}Division of Agronomy, Sher -e- Kashmir University of Agricultural Sciences and Technology of Jammu

ABSTRACT

After independence, there is a surge in human population and it becomes a challenge to feed the growing population. As a result green revolution came into existence in which high yielding, fertilizer responsive varieties were introduced and pernicious agricultural practices such as use of synthetic chemicals, pesticides have been employed which lead to increase crop production and decrease the time of production. While these techniques might help farmers to improve their yield, they are short-sighted in nature lead to environment degradation and can cause poisoning of the food we consume. Hence organic farming is the ultimate solution to prevent this disaster upon human civilization. Organic agriculture relies on crop rotations, the recycling of farm-produced organic materials i.e. crop residues, animal manure, legumes, green manure and off-farm organic wastes and on a variety of non-chemical methods for the control of pests, diseases and weeds. Synthetically compounded fertilizers, pesticides, herbicides, growth regulators and livestock feed additives, products and methods of genetic engineering and burning of crop residue are excluded or severely restricted. The objectives of organic farming are two fold: First, to promote sustainable agriculture i.e. improving agricultural production at levels required for an expanding population without degrading the environment and secondly, to ensure that the agricultural system developed relies as much as possible upon locally available resources. Trifling organic waste management leads to a plethora of problems such as environmental pollution, eutrophication, aesthetic damage to urban landscape, greenhouse gases emission and effects on human health. Since organic wastes are an abundant pool of organic matter and valuable plant nutrients, agricultural recycling of these wastes appears to be a promising alternative enabling value addition and their resourceful utilization. Land application of organic wastes stabilized through techniques such as composting, vermicomposting and anaerobic digestion yielding excellent organic fertilizer like compost augments soil fertility and crop yield. Vermicompost technology has promising potential to meet the organic manure requirement in both irrigated and rainfed areas. It has tremendous prospects in converting on-farm agro-wastes into valuable agricultural input and can enhance the soil health and fertility. Thus various economic uses can be obtained from organic wastes and prevent pollution. Organic farming through waste recycling should be propagated that will help in saving our agro-ecosystem and biodiversity. Additionally, the practice incorporates indirect environmental benefits such as reduced greenhouse gas emissions, land conservation due to reduced landfilling of wastes, and substitute to chemical fertilizers.

Keywords: Organic Farming, Sustainable Agriculture, Crop residues, Crop rotations, Vermicompost and Agro-ecosystem.

Promising Cultural Weed Management Practices to limit crop-weed competition in Peas (*Pisum sativum* L.) in the North-western Himalayan Region

Gaytri Hetta, SS Rana, Sarwan Kumar and Belal Ahmad Mujahed

Department of Agronomy, College of Agriculture, CSKHPKV, Palampur 176062, HP, India

ABSTRACT

Garden pea is an important off-season vegetable, which is widely grown as cash crop during winter and summer in north-west Himalayan region. Among the several factors responsible for low yield of winter legumes, competition due to weeds is the important one. Uncontrolled weed growth in pea has been reported to cause yield reductions from 37.3 to 64.4%. Slow initial growth, wider spacing and fairly good application of FYM along with inorganic fertilizers provide congenial environment for weeds. The dominant weed species in pea crop were *Stellaria media*, *Phalaris minor*, *Vicia sativa*, *Tulipa asiatica*, *Vicia hirsuta*, *Avena ludoviciana*, *Poa annua* and *Anagallis arvensis*. Since environmental protection is a global concern, the age-old agronomic manipulations, viz. tillage and inter-cultivation, inter cropping, mulching, cover crops, crop rotation, higher seed rate or plant populations, planting at closer spacing, nutrient management, planting methods, and other agro-techniques

3rd International Conference on “Global Initiative in Agricultural, Forestry and Applied Sciences for Food Security, Environmental Safety and Sustainable Development (GIAFAS-2021)”

are used for weed management. Therefore, a review based on cultural weed management practices in organically managed pea was done.

Keywords: pea, weeds, weed management practices, crop-weed competition, cropping system, organic system

Development of Targeted Yield Equations on German Chamomile (*Matricaria retutica*) in Young Alluvium Calcareous Soils

S. N. Suman, Shankar Jha, Sanjay Kumar Singh, Vipin Kumar and J. Prasad

Department of Soil Science, Dr. Rajendra Prasad Central Agricultural University, Pusa (Bihar), Samastipur -848125

ABSTRACT

German Chamomile possesses anti-anxiety properties and could be used to treat stress and insomnia. There are limited reports of cultivation of medicinal and aromatic plants by farmers on the basis soil test and crop requirement. Target yield equations generated from STCR-IPNS technology ensures sustainable crop production as well as economic use of costly fertilizer inputs. The target yield approach also provides scientific basis for balanced fertilization of crops by creating the balance among the nutrients from the external sources and from the soil.

The complex experiment on German Chamomile was conducted in 3 fertility gradient strips with 4 levels each of N (0, 50, 100 and 150 kg N/ha), P (0, 20, 40 and 60 kg P₂O₅ / ha), K (0, 20, 40 and 60 kg K₂O/ha) and Rapeseed oilcake (0, 5 and 10 q/ha) at experimental field of STCR , Soil Science, RAU, Pusa, Bihar during 2005-06. The results of the study showed that the nutrient requirement to produce one quintal of dry German Chamomile flower (NR), contribution from soil nutrients (CS) and contribution from fertilizer nutrients applied (CF) increased with increasing levels of organic manure (Rapeseed oilcake). NR (kg/q) varied from 5.26 to 5.27, 0.20 to 0.27 and 4.84 to 6.23 for N, P₂O₅ and K₂O, respectively. Similarly contribution of soil was from 7.09 to 14.35, 2.97 to 4.82 and 22.11 to 37.02 for N, P₂O₅ and K₂O, respectively. Fertilizer use efficiency (CF) was from 30.22 to 36.45, 3.18 to 6.54 and 72.51 to 103.61 % for N, P₂O₅ and K₂O, respectively.

Fertilizer recommendation schedule indicated that 159 kg N, 73 kg P₂O₅ and 48 kg K₂O is required to produce 15 q/ha of dry German Chamomile flower without using any organic manure in a soil having 225 kg N, 25 kg P₂O₅ and 175 kg K₂O/ha where as 158 kg N, 58 kg P₂O₅ and 39 kg K₂O with 5 q/ha Rapeseed oilcake is required to produced the same yield level (15 q/ha) at the similar fertility status of soil which can be further reduced to 129 kg N, 43 kg P₂O₅ and 27 kg K₂O/ha when 10 q/ha Rapeseed oilcake is to be applied. Thus results showed that there was a saving of 1 kg N, 15 kg P₂O₅ and 9 kg K₂O/ha with the application of Rapeseed oilcake @ 5 q/ha. Similarly 30 kg N, 30 kg P₂O₅ and 21 kg K₂O/ha may be saved with the application of Rapeseed oilcake @ 10 q/ha.

Keywords: Targeted Yield Equations, German Chamomile, Young Alluvium Calcareous Soils

Soil organic carbon fractions and carbon stocks in different orchards of eastern Indo-gangetic plains of India

Vipin Kumar*, S.N. Suman and Kaushal Kishor

Department of Soil Science, Dr. Rajendra Prasad Central Agricultural University, Bihar, Pusa, Samastipur – 848125

ABSTRACT

Soil organic carbon includes a continuum of materials ranging from highly decomposable to very recalcitrant fractions and plays an important role in soil fertility and productivity. It is divided into two major pools, such as labile and stabilized fractions. An investigation was undertaken to evaluate the dynamics of total soil organic carbon (C_{tot}), oxidisable organic carbon (C_{oc}), very labile carbon (C_{frac1}), labile carbon (C_{frac2}), less labile carbon (C_{frac3}), non-labile carbon (C_{frac4}) and SOC sequestration in a 15 year-old fruit orchards. The total mean C increased by 33.9, 27.5, 22.7 and 19.6% in aonla, guava, mango and litchi orchards, respectively. The aonla orchard registered highest significant increase of 36.6, 28.6, 28.0 and 29.3% in C_{frac1}, C_{frac2}, C_{frac3} and C_{frac4}, respectively over control. There is greater accumulation of all the C fractions in the surface soil (0-30 cm). The maximum total active carbon pool was 55.53 g kg⁻¹ in aonla orchard and resulted in 1.33 times higher than control. The carbon management index registered 1.34(aonla orchard), 1.28(guava orchard), 1.23 (mango orchard) and 1.20(litchi orchard) fold increase over control. The aonla orchard registered highest carbon build rate of 0.23 g kg⁻¹ year⁻¹ and resulted in 33.8 % carbon build up over control.

Keywords: Carbon fraction, Carbon management index, Eastern India, Fruit orchard, Carbon stock.

ROLE OF METABOLOMICS IN TOLERANCE TO DROUGHT STRESS

Dr. V. V. Padmaja, Dr. M. Jayaprada and Dr. B. Srinivasulu

College of Horticulture, Anantharajupeta, Dr. Y.S.R. HU, Kadapa Dist. -516101, INDIA

ABSTRACT

Drought stress is one of the most important abiotic factors causing reduction in plant growth and development as well as plant productivity and crop yields. The effect of drought stress will be reflected in many ways, as varied morphological,

3rd International Conference on “Global Initiative in Agricultural, Forestry and Applied Sciences for Food Security, Environmental Safety and Sustainable Development (GIAFAS-2021)”

physiological, and biochemical changes in plants under different water stress. For instance, changes in leaf morphology, effects on shoot and root growth and development, decrease in carboxylation and electron transport chain activities of the chloroplasts in the mesophyll cells. During the drought stress conditions, the closing of stomata occur via the distress signal “abscisic acid” (ABA) which leads to a decreased rate of transpiration and limit photosynthetic activity by decreasing CO₂ influx.

Moreover, drought stress results in accumulation of proline, mannitol, sorbitol, formation of radical scavenging compounds (ascorbate, glutathione, a-tocopherol, etc.), and synthesis of new proteins and mRNAs. Along with proteins, the lipids are the most abundant component of membranes, and they play a role in the resistance of plant cells to environmental stresses. Strong water deficit leads to a disturbance of the association between membrane lipids and proteins as well as to a decrease in the enzyme activity and transport capacity of the bilayer (Caldwell and Whitman, 1987).

The new tools that operate at molecular, plant, and ecosystem levels are revolutionizing our understanding of plant response to drought and our ability to monitor it. In recent years, microarray technology has been applied to identify stress-responsive genes (Swindell, 2006). Novel drought responsive genes may be thus identified and used for enhancing drought tolerance in plants through genetic/metabolic engineering.

Conservation of natural resources and their management through tribal women participation in protected areas of central India

Poonam Xess and Garima Tiwari

Department of forestry, Guru Ghasidas Vishwavidyalaya, bilaspur(C.G)

ABSTRACT

Protected area contributes to conserve the natural resources present in the forest and tribal women play a crucial role in the sustainable utilization of the natural resources. Protected areas directly conserve the resources or species present in the ecosystem through in-situ conservation. According to IUCN category VI protected area with sustainable use of natural resources contribute mainly to local communities and indigenous people depending on natural resources. We have conducted our research in protected areas of central India. We have studied, reviewed and analyzed various research papers, articles and government data. Therefore analyzing the data tribal women are active participation for natural resource conservation and their involvement could increase effective conservation and management of natural resources in protected areas. In the site where tribal women, SHGs are active the various natural resource can be conserve and manage directly or indirectly. Such efforts of tribal women can conserve and manage the natural resources of protected areas.

Genetic studies in F₂ population of Tomato (*Solanum lycopersicum* L.) for yield and quality traits

Mamatha, N. C. *, Lingaiah, H. B. and Jyoti, H. K.

Department of Vegetable Science, College of Horticulture, UHS campus, GKVK (PO), Bengaluru-560 065

ABSTRACT

A study was conducted to find out the genetic variability in F₂ population of cross Utkal Raja x Arka Sourabh. Higher estimates of PCV and GCV were observed for the traits like plant height, number of branches at peak harvest stage, number of clusters per plant, days to first flowering, number of fruits per plant, average fruit weight and yield per plant. For traits like TSS and total acidity the estimates of PCV and GCV were found moderate. Higher heritability coupled with high genetic advance as per cent mean were observed for plant height, number of clusters per plant, days to first flowering, number of fruits per plant, average fruit weight, yield per plant and total acidity indicates the predominance of additive gene component. Thus, there is much scope for improving these characters by simple selection in further generations.

Keywords: Tomato, Variability, PCV, GCV, F₂ population, Yield.

Genetic characterization and Population structure study of elite genotypes for upland cotton (*Gossypium hirsutum*) using microsatellite based markers

Pawan Kumar^{1*}, Somveer Nimbale¹, R. S. Sangwan¹, Neeraj Budhlakoti² and Sagar¹

¹*Department of Genetics and Plant Breeding, CCS Haryana Agricultural University-125004, India*

²*ICAR-Indian Agricultural Statistics Research Institute, New Delhi-110012, India*

ABSTRACT

Present study investigates the genetic diversity and population structure among the 96 genotypes panel of upland cotton. A diverse set of genotypes was selected from the complete germplasm and breeding material available at CCS Haryana Agricultural university, Hisar, Haryana. A total of 170 simple sequence repeat (SSR) were used in the present study and out

3rd International Conference on “Global Initiative in Agricultural, Forestry and Applied Sciences for Food Security, Environmental Safety and Sustainable Development (GIAFAS-2021)”

of them, only 97 showed polymorphism using agarose gel electrophoresis. A total of 293 diverse alleles were generated by these 97 polymorphic markers which were used for further downstream analysis. Average number of alleles per SSR (3.021), gene diversity (0.551) and polymorphism information content (0.485) showed the genetic marker panel used in the present study was highly diverse, informative and all the genotypes were grouped in to three major clusters on the basis of maximum likelihood value of delta K obtained from population structure analysis. Analysis of molecular variance also showed high genetic variance among the genotypes (97%) as compare to among sub-populations. The results of the present study showed that the genotypes in the different clusters differs significantly to another cluster and further genotypes with private alleles could be used in cotton improvement programmes.

Keywords: Population structure, AMOVA, Cotton, Simple sequence repeat (SSR), *Gossypium hirsutum*

EFFECT OF NANO-SULPHUR FERTILIZER ON SUNFLOWER CROP

R. Rajeswari* and K.S. Subramanian

**Department of Soil Science and Agricultural Chemistry, Tamil Nadu Agricultural University, Coimbatore, Tamil Nadu, India*

ABSTRACT

A pot culture experiment was conducted in Department of Nano Science and Technology, Tamil Nadu Agricultural University, Coimbatore to know the effect Nano-Sulphur (Nano-S) fertilizer on Sunflower crop (KBSH 42) in comparison with other conventional sulphatic fertilizers. The research work was carried out in alfisol with deficient available S status. Treatments of pot culture experiment consist of control, gypsum, nano-S @ 20 and nano-S 40 kg S⁻¹ replicated 4 times in a FCRD. For this experiment, Nano-S was synthesized by aqueous precipitation method and it was characterized using particle size analyzer, zeta potential, UV-Spectroscopy, XRD, FT-IR, SEM and TEM. During the experimentation, soil and plant samples were analyzed for Sulphur content periodically. At harvest, yield and oil content were assessed. Results revealed that, the available sulphur status in nano-S fertilized soil was higher than control regardless of quantities of nano-S applied. The data revealed that nano-S assists in improving the available Sulphur in soils and also enhance the uptake of Sulphur by plants which resulted in enhanced productivity of plants. This may be attributed to the long lasting release of Sulphur from nano-S. Overall, the study suggests that nano-S can be used as a slow release fertilizer to improve the Sulphur use efficiency of oilseed crops.

Keywords: Nano-sulphur, synthesis, characterization, sunflower, crop response

Innovative Extension Systems for Climate Resilient Agriculture

Sujavelu. T., Kalirajan, V., Balamurugan, V and D.Balu

Department of Agricultural Extension, Faculty of Agriculture, Annamalai University

ABSTRACT

Climate change adaptation involves adjustments to decrease the vulnerability of agriculture to current climate variability and to future changes. Farmers have traditional knowledge on sowing and harvest times and crop management practices. Farmers may not have the necessary information of possible climate adaptation options without an effective network of extension services that can filter knowledge gained through science to grass roots. In addition, it is necessary that farmers possess the necessary skills to implement an alternative production technique. Under the climate change scenario, due to uncertainty in rainfall conditions and occurrence of extreme weather, farmers need to be supported with both climate and weather information for sustainable crop production. Agriculture extension system plays very important role in enhancing the knowledge and skills of farmers for improving agricultural productivity as lack of awareness among farmers about good agricultural practices is always been a key limiting factor for improving productivity levels. Thus, there is a clear and distinct role for strengthening extension services in agriculture to enhance farmer awareness of potential adaptation response options. Agricultural extension personnel are the main stakeholders to communicate with the farmers on how to cope with climate change through adaptation strategies. There is a need to develop appropriate training modules for the agricultural extension staff on the science of climate change and the various adaptation and mitigation strategies available in the universities, research institutes and the government departments. In this way, extension personnel will be acquainted with knowledge on climate change.

Keywords: Climate change, adaptation and sustainable crop production

NEED FOR DEVELOPMENT OF TRIBAL KNOWLEDGE NETWORK FOR SUSTAINABILITY

Vengatesan, D ., Balu, D., Ragunath.S and E.Suriyapriya

Department of Agricultural Extension, Annamalai University.

Department of Agricultural Extension Education, UAS, Raichur.

ABSTRACT

Tribals are the most indigenous people with multiple skills and hidden in to the traditional society of tribals. They act as integrated solution for sustainable and effective utilization of forest resources. As they are highly personal in their

3rd International Conference on “Global Initiative in Agricultural, Forestry and Applied Sciences for Food Security, Environmental Safety and Sustainable Development (GIAFAS-2021)”

communication aspects, their age old sustainable and indigenous practices are not fully accessed by the researchers till date. So the field of development of tribal knowledge network gains more attention of researchers. The Knowledge network is a place where all the knowledge of all the individual farmers are collected and collectively utilized for the development of the human race. Since tribal groups are very vast and they are highly diversified in India. Each tribal community has different indigenous knowledge of different forms and practices. If they are collected and gathered at one door step in the name of network of tribal knowledge, it may be useful development of more effective sustainable technologies.

Keywords: Tribals, Knowledge Network and Sustainability

TRIBALS FLAVOR THE SPICE INDUSTRY

Ragunath, S and S.K.Kammar

Department of Agricultural Extension Education, College of Agriculture, University of agricultural science, Raichur

ABSTRACT

India is one of the leading cultivator and exporter of spices in the World. Indian spices are highly valued in the global spice markets. On the other hand the cultivation, processing and selling of the spices by the tribals uplifting them both socially and economically. The government has also played a catalytic role in the sector for empowering the tribal through start-ups. Since the foreign invasion in India the spice industry in India attained its full fledged reach in the world trade. So it is a very effective to boost the agri-preneurship towards spice related start-ups for empowering them. As they have deep rooted knowledge on the indigenous utilization pattern of spices for treating diseases and value added products. If these knowledge are converted in to production and processing units they may pave the way for fast social empowerment of the tribal communities.

Keywords: Spices. Tribals and Empowerment.

A STUDY ON COST AND RETURNS OF JAGGERY PRODUCTION IN TAMILNADU

K.Marikannan¹, A.Mehazabeen² and G.Srinivasan³

Department of Agricultural Economics, Annamalai University, Chidambaram, Tamil Nadu- 608 002.

ABSTRACT

In the recent decades the Indian sugar industry has suffered with high stocks, low prices, and high raw material cost. As a result, the prices of sugar fall down and sugar prices do not cover the raw material cost and the cost of production of sugar. This reason why the payment is delayed and low payments to the farmers for their sugarcane. This is the situation where our Indian sugarcane growing farmers are facing. So, diversion of sugarcane towards jaggery processing may give more benefits to the farmers. Hence an attempt is made in the present study to examine the production performance of jaggery in Tamilnadu with special reference to Namakkal district.

The study was undertaken with the following objectives (i) To analyze the costs and return in the production of Jaggery in the selected area (ii) To give policy suggestions based on the results of the study. The primary data was collected from the farmers who are cultivating sugarcane and having Jaggery processing units in their own field. 30 farmers were randomly selected from Paramathi Velur taluk and 20 from Namakkal taluk of Namakkal district with a total of 50 farmers having Jaggery units as well as growing sugarcane. The cost of establishing a jaggery processing unit was around Rs. 4,02,650 and Rs. 5,73,000 in Paramathi Velur and Namakkal taluks respectively. The investment on processing shed, and cane crusher accounted for about 80.66 per cent of the total investment in Paramathi Velur and 76.25 per cent in Namakkal. The study suggested that new varieties with better jaggery recovery would be encouraged for cultivation and technology up gradation of jaggery units for increased efficiency and jaggery outturn were needed in the study area.

Keywords: Jaggery Processing, Fixed cost, Net Income

A CONSTRAINT ANALYSIS ON PRODUCTION AND MARKETING OF MAIZE IN TAMILNADU

G.Srinivasan¹, K.Marikannan² and A.Mehazabeen³

Department of Agricultural Economics, Annamalai University, Chidambaram, Tamil Nadu- 608 002.

ABSTRACT

Maize (*Zea mays* L) is a cereal grain belonging to the family Gramineae and is known as 'Queen of Cereals' because of its several uses. Maize is the third most important cereal, after rice and wheat, for human food. Agriculture is the primary occupation of Perambalur district of Tamilnadu and Perambalur district stands first in Maize cultivation in Tamilnadu with contribution of 12.24 percent of total area, 17.13 percent of total production of the State. Perambalur district ranked first in

3rd International Conference on “Global Initiative in Agricultural, Forestry and Applied Sciences for Food Security, Environmental Safety and Sustainable Development (GIAFAS-2021)”

maize productivity with 11173 kg/ha. Markets for maize are very meagrely spread throughout the maize growing regions. Most of the maize grain produced is sold in local village markets, where grain prices are 2 - 8 per cent lower than those in the nearest regulated markets. Lack of proper handling of goods at farm gate leads to losses before reaching market and crores are lost due to poor marketing chain.

At this juncture, this study was undertaken with the following specific objectives: (i) To analyse constraints on production of maize in the study area and (ii) To analyse constraints on marketing of maize in the study area and policy suggestions based on the results of the study. **The present study was carried out in the Perambalur district as it was ranked first in area and production of maize among the maize growing districts of the state. From the district, two blocks with maximum cultivated area of maize and 120 farmers comprising 60 sample farmers from each block were selected. From the blocks 5 villages from each block and 12 farmers from each village were selected randomly. The Garrett Scoring Technique was used to rank the constraints in maize production and marketing.** The most important constraint identified by the farmers in maize production in the study area was availability of labour (Garrett score :72.25) followed by no irrigation facilities (Garrett score :65.30) while the most important marketing constraint expressed by the farmers was more number of market intermediaries (Garrett score :68.65) followed by low market price as the second marketing constraint (Garrett score :64.75). **The study suggested that providing modern machineries related to harvesting and value addition might boost the production of maize further in the study area.**

Keywords: Garrett Ranking, Maize Production, Constraint Analysis

A CONSTRAINT ANALYSIS ON PRODUCTION OF JAGGERY IN TAMILNADU

A.Mehazabeen¹, K.Marikannan² and G.Srinivasan³

Department of Agricultural Economics, Annamalai University, Chidambaram, Tamil Nadu- 608 002.

ABSTRACT

Jaggery making is the oldest cottage industry in India and jaggery has been an important food item from ancient times. The jaggery industries is labour intensive and provides employment to millions of sugarcane farmer and others. It utilizes local skills and resources gives quick returns as it involves less gestation period and above all, it is one of the mass consumption goods industries. In the recent years, number of jaggery processing units are decreasing due to various constraints. At this juncture, constraint analysis on production of jaggery in Tamilnadu was carried out with the following specific objectives: (i) To analyze constraints on jaggery production among the sample units and (ii) To give policy suggestions based on the results of the study.

The Namakkal district of Tamilnadu was selected purposively and the farmers who are cultivating sugarcane and having Jaggery processing units in their own field were selected as ultimate samples (50 sample units). Garrett ranking was used to find out the constraints in production of jaggery. Labour scarcity and electrical problem in processing units was found to be the major constraints faced in processing but in jaggery processing, the B: C ratio was higher than unity. The results of the study suggested that jaggery units on an average provide employment to ten men and four women for a period of four to five months and hence encouraging such units offers high potential of providing supplementary income to rural agricultural labour during off seasons in the study area.

Keywords: Jaggery Production, B:C Ratio, Constraint Analysis

Innovative Extension Systems for Climate Resilient Agriculture

Sujavelu. T., Kalirajan, V., Balamurugan, V and D.Balu

Department of Agricultural Extension, Faculty of Agriculture, Annamalai University

ABSTRACT

Climate change adaptation involves adjustments to decrease the vulnerability of agriculture to current climate variability and to future changes. Farmers have traditional knowledge on sowing and harvest times and crop management practices. Farmers may not have the necessary information of possible climate adaptation options without an effective network of extension services that can filter knowledge gained through science to grass roots. In addition, it is necessary that farmers possess the necessary skills to implement an alternative production technique. Under the climate change scenario, due to uncertainty in rainfall conditions and occurrence of extreme weather, farmers need to be supported with both climate and weather information for sustainable crop production. Agriculture extension system plays very important role in enhancing the knowledge and skills of farmers for improving agricultural productivity as lack of awareness among farmers about good agricultural practices is always been a key limiting factor for improving productivity levels. Thus, there is a clear and distinct role for strengthening extension services in agriculture to enhance farmer awareness of potential adaptation response options. Agricultural extension personnel are the main stakeholders to communicate with the farmers on how to cope with climate change through adaptation strategies. There is a need to develop appropriate training modules for the agricultural extension staff on the science of climate change and the various adaptation and mitigation strategies available in the universities,

3rd International Conference on “Global Initiative in Agricultural, Forestry and Applied Sciences for Food Security, Environmental Safety and Sustainable Development (GIAFAS-2021)”

research institutes and the government departments. In this way, extension personnel will be acquainted with knowledge on climate change.

Keywords: Climate change, adaptation and sustainable crop production

Efficacy of different insecticides against tea mosquito bug, *Helopeltis antonii* Signoret (Hemiptera: Miridae) in cashew in coastal Karnataka

Raviraja Shetty, G., Lakshmana and Abhishek M. S.

Agricultural and Horticultural Research Station, Ullal, Mangalore. Keladi Shivappa Nayaka University Agricultural and Horticultural Sciences, Shivamogga.

ABSTRACT

Cashew is one of the major significant sources of foreign currency for our country and it is also one of the important crops of coastal region of Karnataka State. Nearly 60 different pests have been reported on cashew. Among them the Tea Mosquito Bug, *Helopeltis antonii* is the most serious one, which is responsible for considerable yield losses in cashew. The present experiment was conducted to find out the effective insecticide for the management of tea mosquito bug in cashew at Agricultural and Horticultural Research Station, Ullal, Mangalore. The results revealed that among the different insecticides tested the Buprofezin 25 SC @ 2 ml/l was found best insecticide for the management of tea mosquito bug as it recorded least per cent incidence (2.98) and followed by Fenitrothion 50 EC (3.28 per cent incidence). The insecticide Azadiractin 5% was found least effective by recording highest per cent incidence (5.92) tea mosquito bug and followed by Lambda cyhalothrin 5 EC (5.28 per cent incidence). The response of these insecticides was also observed on the yield attributes, with highest nut yield and cost benefit ratio was recorded in Buprofezin 25 SC @ 2 ml/l.

Keywords: Cashew, Cost benefit ratio, Insecticides, Tea mosquito bug.

Evaluation of some bioagents, botanicals and biorational insecticides against mealybug, *Phenacoccus solenopsis* (Hemiptera: Pseudococcidae) in tomato under field conditions

M. S. ABHISHEK^{1*}, B. C. HANUMANTHASWAMY¹, T. VENKATESAN² and K. SELVARAJ²

¹*Department of Agricultural Entomology, University of Agricultural and Horticultural Sciences, Shivamogga-577204, Karnataka, India*

²*ICAR- National Bureau of Agricultural Insect Resources, Bengaluru-560045, Karnataka, India*

ABSTRACT

The efficacy of different biocontrol agents (Entomopathogens and predator), botanicals and biorational insecticide was evaluated against mealybug, *Phenacoccus solenopsis* (Hemiptera: Pseudococcidae) in tomato under field condition during summer 2019. The experimental results revealed that fish oil rosin soap @ 2 ml/L was the most effective in reduction (71.28 %) in the *P. solenopsis* population over untreated control followed by azadiractin 5% @ 2 ml/L. The lowest per cent reduction (21.72 %) of mealybugs were recorded in *Chrysoperla zastrowi sillemi* and followed by *Metarhizium anisopliae* (28.72 %). The response of these biocontrol agents along insecticide check (spiromesifen 280 SC) was also observed on the tomato yield attributes, with highest fruit yield and cost benefit ratio of 52.96 t/ha (6 pickings) and 1:3.49, respectively, was recorded in fish oil rosin soap treatment followed by azadiractin (50.00 t/ha and 1:3.22 fruit yield and cost benefit ratio, respectively).

Keywords: Tomato, *Phenacoccus solenopsis*, fish oil rosin soap, azadiractin, spiromesifen, cost benefit ratio.

Effect of different carrier agents on freeze dried button mushroom: a review

***Rafeeya Shams, Jagmohan Singh**

¹*Division of Food Science and Technology, Sher-e Kashmir University of Agricultural Sciences and Technology-Jammu*

ABSTRACT

Mushrooms are a good source of protein, minerals, vitamins, and antioxidants along with numerous medicinal properties. Mushrooms are soft textured, highly perishable but are susceptible to microbial attack due to high level of moisture content. Drying of mushrooms is essential to carry out to reduce water activity. As mushrooms are very sensitive to temperature, choosing the right drying method can be the key for a successful operation. The preservation of aroma is essential for accessing quality of processed food products, and in particular for the case of mushrooms, which are very much used for culinary preparations because of their unique aroma. Freeze-drying has been identified as an effective method for drying of products with minimal deterioration to available food nutrients. Powder products produced from fruits like mushroom may present problems such as high hygroscopicity and caking due to the presence of low molecular weight sugars and acids with a low glass transition temperature. Thus, the use of carrier agents can result in powders with different thermal and

3rd International Conference on “Global Initiative in Agricultural, Forestry and Applied Sciences for Food Security, Environmental Safety and Sustainable Development (GIAFAS-2021)”

microstructural properties, making easier the drying process and reducing the hygroscopicity of the dehydrated product. Carrier agents such as maltodextrin and soy protein isolate (SPI) when introduced into the feed solution, influence the properties and stability of the powder and exhibit comparable or even better encapsulating efficiency, and higher stability against oxidation.

Keywords: Freeze drying, button mushroom, texture, shelf life.

KNOWLEDGE OF ENVIRONMENTAL ISSUES AMONG COLLEGE STUDENTS OF DHARWAD, KARNATAKA, INDIA

SHOBHA KASAR* and SAKEENA NAIKWADI**

Department of Family Resource Management, College of Community Science, University of Agricultural Sciences, Dharwad-580 005, Karnataka, India

ABSTRACT

A study on knowledge of environmental issues among college students of Dharwad, Karnataka, India this study was conducted during the year 2016-17. The objectives of this study, to measure the environmental awareness level among the college students and to study the general environmental practices among the college students. The sample of the study comprises of 50 students, data collected from three colleges of Dharwad district. The questionnaire method was used to collect the data. Appropriate statistical techniques like percentage, frequency and Garrett ranking test was used to analyze the data. The findings of the study revealed that, air pollution is the major problem faced in their daily life. Ozone layer is the Protective shield and earth's umbrella now it is damaging by increasing temperature of earth. Water is most affected or polluted by housing activities and agriculture is main causes for deforestation, Students agreement with regularly watching TV programmes about environmental issues to know the protection of environment.

Keywords: environment, knowledge, awareness, attitudes, practices

Haldina cordifolia: A suitable in-vitro and in- Vivo regeneration technique for its domestication and its conservation practices.

Astha Singh¹ Dr. K.K Chandra²

Dept. of Forestry, Wildlife & Environmental sciences, Gurughasidas Vishwavidyalaya (a central university) Bilaspur, (C, G) - 495001, India

ABSTRACT

Haldu (*Haldina cordifolia*, syn. *Adina cordifolia*) is the tree species that belongs to the family Rubiaceae, distributed across all parts of India except Rajasthan. It is a large deciduous forest species that requires mean annual rainfall between 1000-2000mm with well-drained soil. Due to its heavy exploitation for fuel and fodder takes immediate attention for natural regeneration and establishment as well as conservation. Due to its minute seed size, their natural regeneration rates are very low and because of this reason, it is crucial to unearth/explore suitable regeneration practices. It is a socially important plant species because of its medicinal and timber value. It can treat ulcers, deep wounds, jaundice, stomach ache, malarial fever, etc. with chemical constituents of tree's leaves, barks, and roots and due to its high-quality timber this species was found very suitable for wooden construction works like flooring, railway carriages, etc. This species can grow both in in-vitro and in-vivo conditions but at very low germination rates. More attention and studies are required for in-vivo and in-vitro regeneration to enhancing the growth and conservation practices of this medicinally important plant.

Keywords: Regeneration, in-vitro, in-vivo, domestication, conservation, ulcers, jaundice, malarial fever.

Effect of inulin supplementation as prebiotic on the performance of Barbari goats fed high or low-concentrate diet

Abhishek Kumar, Ahmad Fahim*, D.K. Singh, Amit Kumar, Nazim Ali, Debashis Roy and G. Chandra

Department of Livestock Production Management, Sardar Vallabhbhai Patel University of Agriculture and Technology, Modipuram, Meerut- 250110, India

ABSTRACT

The aim of the study was to investigate the effects of dietary supplementation of inulin as prebiotic on the performance of Barbari goats fed high or low-concentrate diet. For the study eighteen yearling female Barbari goats of uniform age, sex and conformation were selected. They were allocated into three groups with six animals per treatment distributed based on their

3rd International Conference on “Global Initiative in Agricultural, Forestry and Applied Sciences for Food Security, Environmental Safety and Sustainable Development (GIAFAS-2021)”

live body weights using completely randomized block design. The control group was fed on conventional diet having concentrate to roughage ratio of 50:50 without inulin supplementation. The treatment group T1 and T2 consisted of animals fed low concentrate diet (LCD) having concentrate to roughage ratio of 40:60 and high concentrate diet (HCD) having concentrate to roughage ratio of 60:40, respectively, with 2% level of inulin supplementation in both the groups on % DM basis. The results showed that there was an overall increase in dry matter intake in inulin supplemented group. The average initial and final body weight of barbari goats in all the three groups measured at fortnightly intervals did not differ between the groups. However, the mean daily body weight gain in treatment group T2 was higher followed by group T1 and the control group. There was an overall improvement in feed conversion efficiency in Barbari goats under treatment groups in comparison to control group. The body condition score and faecal score of experimental goats was improved in inulin treated group compared to control group during the trial period. The results of the study suggested that dietary supplementation of inulin in growing goats fed high or low concentrate diet may have beneficial effects on their performance and feed utilization efficiency.

Keywords: Barbari goats, Growth performance, Inulin, Supplementation

Foreign Direct Investment and the Indian Economy

Keshav Kumar

Department of Agricultural Economics and Management, Rajasthan College of Agriculture, Maharana Pratap University of Agriculture and Technology, Udaipur- 3130304, Rajasthan, India

ABSTRACT

Foreign direct investment (FDI) is when a company takes controlling ownership in a business entity in another country. Generally, FDI takes place when an investor establishes foreign business operations or acquires foreign business assets, including establishing ownership or controlling interest in a foreign company. FDI is an important monetary source for India's economic development. Economic liberalisation started in India in the wake of the 1991 crisis and since then, FDI has steadily increased in the country. India, today is a part of top 100-club on Ease of Doing Business (EoDB) and globally ranks number 1 in the greenfield FDI ranking.

Keywords: Ease of Doing Business, Economic Liberalisation and Greenfield FDI.

The New Integrated Pest Management Paradigm for the Modern Age

Anjali Nagori¹, Manish Bishnoi², Rakesh³

¹Department of Nematology, Rajasthan College of Agriculture, Maharana Pratap University of Agriculture and Technology, Udaipur- 313 004, Rajasthan, India

²Department of Entomology, College of Agriculture, Gwalior, Madhya Pradesh, India

³College of Agriculture, AU, Jodhpur-342311, Rajasthan, India

ABSTRACT

Earlier models of integrated pest management (IPM) focused on ecological aspects of pest management. With the recent developments in agricultural technology, modern communication tools, changing consumer trends, increased awareness for sustainably produced food systems, and globalization of trade and travel, there seems to be a need to revisit the IPM paradigm as appropriate for modern times. A new model, built on earlier models based on ecological and economic aspects, is expanded and reconfigured to include management, business, and sustainability aspects and emphasize the importance of research and outreach. The management aspect contains four components of IPM that address the pest management options, the knowledge and resources to develop management strategies, the management of information and making timely decisions, and the dissemination or sharing of information. With the business aspect that includes the producer, consumer, and seller, and the sustainability aspect that covers economic viability, environmental safety, and social acceptability, the new model presents the human, environmental, social, and economic factors that influence the food production.

Keywords: Integrated pest management (IPM), Environmental safety, Food production.

Impact of Trace Minerals Supplement on Reproductive Performance of Crossbred Cattle

Dheeraj Kumar¹, Rajendra Kumar²

¹Department of Animal Production, Rajasthan College of Agriculture, Maharana Pratap University of Agriculture and Technology, Udaipur- 313 004, Rajasthan, India

²Department of Animal Husbandry & Dairying, Institute of Agricultural Sciences, Banaras Hindu University, Varanasi, Uttar Pradesh, India

ABSTRACT

In lactating animals, the majority of factors like nutrient intake, physiological health, housing management and atmospheric conditions affect reproductive performance of the animal. In dairy animals the main factor affecting reproduction is nutrition

3rd International Conference on “Global Initiative in Agricultural, Forestry and Applied Sciences for Food Security, Environmental Safety and Sustainable Development (GIAFAS-2021)”

status that too traces minerals. So to have a good return from the livestock trace minerals with balanced feeding of the animals must be done. Optimum feeding of minerals with respect to the various stages of reproductive life cycle must be done to increase the reproductive performance.

Keywords: Lactating animal, Nutrients, Reproductive performance and Minerals.

Prosopis Cineraria Based Agroforestry for Hot Arid Regions of Rajasthan

Ankush Godara¹, Lokender Singh²

*Department of Horticulture¹, Department of Soil Science & Agricultural Chemistry²
SHUATS, Allahabad – 211007, India*

ABSTRACT

‘Khejri’ (*Prosopis cineraria*) is the state tree of Rajasthan, linked with the socio economic development of Indian Thar Desert. *Prosopis cineraria* (L.) is a tree endemic to hot deserts of India, belonging to the family Leguminosae. This tree is termed as ‘Kalptaru’ or the ‘king of desert’ owing to its food, feed, medicinal values. Pods locally called “Sangri” are considered as dry fruit of desert and are one of the main ingredients of quintessential Rajasthani dish - The Panchkuta. Khejri is worshipped by a large number of people in the state specifically Bishnoi community. The tree is small to medium size, can withstand extremes of temperature (up to 48^o C).

The Khejri based agroforestry systems were found to provide all ecosystem services. In total, we identified fourteen services provided by Khejri based agroforestry systems. Khejri-based agri-silvicultural and Agri-Silvi-horticultural systems provided more services and profits than sole cropping or other land-use systems in the region. Soil fertility and organic matter were also more under Khejri based agroforestry system as compared to other systems. Khejri based agroforestry systems enhanced the farm income, improved soil fertility, provided nutrition and resilience under hostile climatic conditions without degradation of land and other natural resources. Identification of possible ecosystem services from Khejri based Agroforestry systems in our study will provide an instrument to the policymakers for assessing monetary outcomes of Khejri based agroforestry systems.

In western area of Rajasthan the trees influenced the fodder (green and dry) yield of associated crops. Fodder yield during both rainy (kharif - July-September) and winter (rabi - October-January) seasons was more in association with khejri trees as compared to sole cropping of fodder crops. This is a species representing all five F viz., Forest, Fiber, Fuel, Fodder and Food. This tree is also mythological important in local communities. High value of this species recognized as a State symbol (state tree of Rajasthan).

Keywords: Agroforestry, Ecosystem, Arid, Khejri

Synthesis of cellulose nanofibrils and development of composites

Garima Joshi

IWST Bengaluru Shakti Singh Chauhan, Director, IPIRTI, Bengaluru

ABSTRACT

Cellulose, a linear biopolymer is present naturally in all plants. Lignocelluloses are composed of cellulosic nano-fibrils which can be disintegrated by chemical, mechanical and enzymatic methods in order to obtain nanocellulose. Nanostructured cellulose has received tremendous attention due to its inherent unique properties such as high strength, high surface area, low toxicity, biocompatibility, bio degradability and low cost, which makes it an ideal nanomaterial for diverse applications. Hence, this study highlights synthesis of cellulose nanofibrils (CNF) and development of composites. The particle size distribution of prepared CNF was carried out using Dynamic Light Scattering (DLS). Composites were further subjected to mechanical testing (MOR) in order to determine the strength of the boards. Results indicated that chemi-mechanical process proved to be an effective way for preparing cellulose nanofibrils from bamboo pulp. Results of DLS analysis revealed that the size of CNF lies in nano range. Mechanical properties suggests that boards produced with CNF as a binder exhibited good strength properties and nano size of the fibrils gives added advantage owing to high surface area and high reactivity of the nano form in comparison to its bulk counterpart. Since this study rotates around synthesis of bio composites using cellulose derived from various sources, it promotes sustainability by mitigating utilization of hazardous chemicals like formaldehyde in wood and composite based industries.

Keywords: Cellulose, CNF, chemi- mechanical, particle size, DLS, MOR

A Study on Preferences amongst Women and Trans women on Social Aspects of Clothing

Neha Singh, Dr. Pintu Mishra, Dr. Rena Mehta, Dr. Divya Sharma

Swami Vivekanand Subharti University, Meerut

ABSTRACT

A trans woman is somebody who was tagged male at birth but has a feminine sexual category and individuality, and consequently conversion to be alive as a woman and referred to as the third gender. The present research study aimed to

3rd International Conference on “Global Initiative in Agricultural, Forestry and Applied Sciences for Food Security, Environmental Safety and Sustainable Development (GIAFAS-2021)”

study the impact of gender i.e. women and trans women on the frequency, budget and brand preferences for the shopping for apparel. To conduct this study, the related literature on clothing practices, social aspects of clothing, trans women status and consumer behavior was reviewed. The survey method was adopted for Data collection. Purposive random sampling method in conjunction with snowball technique is used to select the samples for the study. A total number of 400 samples were selected among which 200 were women and 200 were trans women. The age group of the subjects selected for the study was 22 to 50 years. Factorial research design was used to see the impact of gender on the social aspects of clothing preferences i.e. frequency of shopping, budget and brand preferences. Data was analyzed using frequency method, percentage method and chi-square. The results shows that there was a significant association between gender and responses pertaining to the pre tested questions. This paper projects the relation between women and trans women on social aspects of clothing preferences.

Keywords: Gender, Trans women, Social Aspects, Clothing Preferences

ROLE OF MINOR FOREST PRODUCES IN SUSTAINABLE DEVELOPMENT

Damini Sharma

ABSTRACT

The fringe villagers of forest areas have their dependency on minor forest produces whether it is nationally specified such as Tendu leaf, Gum or non-specified such as Harra, Sal seed, both the produces are major basis for economical support to the communities existing in the tribal areas. Thus, the study assessed potential production quantities and SWOT analysis of minor forest produces of the state Chhattisgarh which has the third largest forest cover of India. The people of the state have major concern on tendu leaf compare to the other forest produces. The outcome of the work concluded the strength, weakness, opportunity and threat of minor forest produces sector of the area. As the tribal state and covering large forest area, the minor forest produces have greater potential to contribute in achievement of sustainable development goals.

Keywords: Minor forest Produces; Minimum support price; Tribal; Marketing Channel; Tendu leaf

Effect of temperature and pH level on the growth of bacterial wilt causing *Ralstonia solanacearum* bacteria under in vitro conditions

R. R. Bhanwar

S.G. College of Agriculture and Research Station (IGKV), Jagdalpur-494005, Bastar, Chhattisgarh, India

ABSTRACT

Bacterial wilt is one of the major diseases of all solanaceous plants. The disease is known to occur in the wet tropical, subtropical and some temperate regions of the world. The disease is caused by the bacterium *Ralstonia solanacearum* (Smith) Yabuuchi et al, previously known as *Pseudomonas solanacearum*. In Chhattisgarh state, Bacterial wilt of solanaceous crop caused by *Ralstonia solanacearum* has been grouped under Race 1 and Biovar 3 in the previous study, which attacks wide range of crop plants, ornamentals and weeds in extremely dangerous conditions at 25-28°C temperature and 5.5-6.6 pH in field conditions. Whereas, other groups of races of *Ralstonia solanacearum* have more severe in temperatures range of 35-37°C.

Soil temperature and pH is a major factor affecting the wilt causing bacterial and fungal pathogens and soil microbial community. In the present study, four temperature ranges i.e. 20°C, 25°C, 30°C and 35°C and 10 pH levels i.e. 4, 4.5, 5.0, 5.5, 6.0, 6.5, 7.0, 7.5, 8.0 and 8.5 on *Ralstonia solanacearum* were tested under in vitro condition and found that the population of *Ralstonia solanacearum* (443.33 cfu) were significantly higher on 6.50 pH level at 30°C after 96 hours of inoculation on TZC medium and the population of *Ralstonia solanacearum* was not able to grow in 4 pH at 20°C, 25°C, 35°C and 40°C.

Keywords: *Ralstonia solanacearum*, temperature, pH, bacterial wilt of solanaceous crop

Pattern of Livelihood Diversification of Households in India

Diksha, Sudhakar Dwivedi, Jyoti Kachroo, Akshaydeep

Division of Agricultural Economics and ABM, SKUAST Jammu

ABSTRACT

Increase in mechanization in agriculture has decreased the demand of manual labour thus; various non-farm activities serve the purpose of providing the prospects of employment and income to the household and rural work force. The contribution of agriculture to GDP is continuously decreasing which shows the shift of society from farm to non-farm activities. For assessing the economic well-being of individuals and of society as a whole and to assess the effect of both universal and targeted actions (such as welfare, taxation and other fiscal policies) on the socio-economic groups monitoring changes in

3rd International Conference on “Global Initiative in Agricultural, Forestry and Applied Sciences for Food Security, Environmental Safety and Sustainable Development (GIAFAS-2021)”

sources of income and income distribution for population is important. An attempt has been made to study the pattern of livelihood diversification of household in India with a special case of rural population using the secondary data. Trend showed that over a longer period, from 1991 to 2019, employment in agriculture as a percentage of total employed dropped from 63 percent to 43 percent and per capita income is inversely proportional to poverty. Major source of income are agriculture and wages and salaries where farmers with less than 2 hectares of land are found to be wage labourers and those with more than 2 hectares of land are found to be engaged in agriculture thus a decreasing trend in diversification with increase in size of land holding. Number of income sources had positive effect on the income of households. More diverse the source of income, better the income opportunities. Pluriactivity is observed in agricultural households. The shift from agriculture has been mainly to construction, manufacturing and trade and hotels sector. States like Jammu & Kashmir, Himachal Pradesh, Sikkim, Meghalaya, Andhra Pradesh witnessed an increase in non-farm employment with high income and high diversification. The higher educated groups found to move away from agriculture into more of casual labour and less into remittances. So, policies and interventions for creating employment opportunities have to be designed for promoting NFL in a big way along with strengthening the existing institutions.

Keywords: Livelihood diversification, rural economy, pluriactivity, employment

Allelopathic effect of *Cymbopogon nardus* on *Eupatorium adenophorum*

Sonam Rawat*, Monali Chauhan, Pallavi sati, Sudeep Chandra, M.C. Nautiyal

High Altitude Plant Physiology Research Center, HNB Garhwal University Srinagar

ABSTRACT

Biological invasion of weeds is a big threat to agriculture and ecosystem, challenging global food security. Chemical and mechanical approaches to weed management have adverse effects on the ecosystem, viz damage to native flora, soil erosion. Biological management of weeds through allelopathic activity can be a valuable choice to minimize the weed invasion. Hence the present study aims to manage an invasive weed *Eupatorium adenophorum* Spreng using environmentally friendly approaches. *Cymbopogon nardus* L. was selected for intercropping with *E. adenophorum*, two kinds of approaches were followed: - 1st was to find out the effect of different concentrations of powdered crude material of *E. adenophorum* on the growth and biochemistry of *C. nardus*, the 2nd approach was planting both *E. adenophorum* and *C. nardus* together to find out the allelopathic interaction in the field conditions. The soil rich with higher concentration of *E. adenophorum* crude powder influence the growth and biochemistry of *C. nardus*, concentration till 5% found suitable for plant growth and also showed higher value of Total Phenolic Content (TPC), Total Soluble Sugars (TSS). In field study all the the Leaf area, number of leaves, TPC and TSS of *C. nardus* showed negative correlation with morphological and biochemical parameters of *E. adenophorum*. The survival of *C. nardus* in the *E. adenophorum* farruginous soil, and inhibition of *E. adenophorum* intercropped with *C. nardus* are key finding of our study. The present study suggested that plantation of *C. nardus* can be a valuable choice (due to commercial value in pharmaceutical and essential oil industries) at the places which are already invaded by *E. adenophorum*.

Keywords: Allelopathy, Weed management, Sustainability

Correlation coefficient and Path analysis for seed yield and its attributing traits in Niger [*Guizotia abyssinica* (L. f.) Cass.]

Dr. J.L. Salam and Kusumlata baghel,

S. G. College of Agriculture and Research Station, Jagdalpur 494005 Chhattisgarh, India

ABSTRACT

The present study “Correlation coefficient and Path analysis for seed yield and its attributing traits in Niger [*Guizotia abyssinica* (L. f.) Cass.]” was carried with 53 niger accession including 3 check varieties. At the instructional cum research farm of S.G. College of agriculture and research station, Jagdalpur (C.G.) during kharif 2017. Present investigation indicated that genotypic correlation was higher in magnitude than their respective phenotypic correlation for all traits. Seed yield per plant (g) had highly significant positive correlation with harvest index (%) followed by capitulum per plant, seeds per capitulum, primary branching per plant, straw yield per plant (g), test weight (g), oil content (%), plant height (cm) at genotypic and phenotypic levels. The data revealed that the highest positive direct effect on seed yield per plant (g) was harvest index (%) followed by straw yield per plant (g), capitulum per plant, days to 50% flowering and oil content (%) these characters are very important because they are directly proportional to seed yield per plant (g) and that could be used in selection for high yielding genotypes of Niger crop.

Keywords: Path analysis, correlation coefficient analysis, *Guizotia abyssinica*,

Changes in Structural Characteristics of Humic acid in soils having different nutrient management practices as revealed by spectroscopic techniques

Priya Saini¹, Abir Dey² and Mahesh C. Meena²

Division of Agricultural Chemicals, Division of Soil Science and Agricultural Chemistry, ICAR-Indian Agricultural Research Institute, New Delhi 110012

ABSTRACT

The intensive cropping in northwestern Indo-Gangetic Plains (NW-IGP) for past four decades has been widely reported the decline in the quality of soil organic matter. It has been emerged from the reports from different on-going trials under the aegis of All India Coordinated Research Project on Long Term Fertilizer Experiments (AICRP-LTFE), that integrated nutrient management (INM) can be one option to stabilize crop productivity and have a sustainable system. For the study, the surface (0-15 cm) soil samples were collected from selected treatments of the on-going AICRP-LTFE, ICAR-IARI, New Delhi under maize-wheat system after wheat harvest. The selected treatments viz., Unfertilized control, N (Recommended doses of N only), NPK (Recommended doses of N, P and K), 150% NPK (150% of recommended doses of N, P and K) and NPK+FYM (recommended NPK along with 5 t farmyard manure/ha) were studied to assess the changes in structural characteristics of humic acids as affected by long-term integrated nutrient management

The humic acids (HAs) were extracted by alkali (sodium hydroxide - sodium pyrophosphate) mixture in N₂ environment. The amount of HA extracted from soil was significantly high for NPK+FYM plot. The HA extracted from NPK+FYM had the highest E₄/E₆ ratio indicating least aromaticity as compared to very low E₄/E₆ ratio under control, N and NPK. The Fourier transformed infrared spectroscopy (FT-IR) of different HAs extracted from treatments showed all the representative bands of the functional groups commonly present in HA. The various spectroscopic studies predict that organic carbon from control was highly aromatic while from plots having farm yard manure and chemical fertilizer treatment organic carbon was least aromatic. Solid state ¹³C NMR spectrum of the extracted HA also suggested the similar trend. The lower aromaticity and acidity of HA extracted from INM plots indicated a higher inflow of organic matter in those plots, often in excess of the assimilation capacity of soil microbes. Therefore, continuous application of FYM along with recommended NPK improved the C quality as indicated by lower aromaticity due to lesser rates of humification, which are beneficial in terms of soil health and sustainability of the cropping system.

Tolerance of Eisenia fetida towards herbicide (metsulfuron-methyl)

Anu Bala Chowdhary^{1*}, Jahangeer Quadar¹, Sharanpreet Singh¹, Jaswinder Singh², Adarsh Pal Vig^{1#}

¹Department of Botanical and Environmental Sciences, Guru Nanak Dev University, Amritsar, Punjab 143005, India

² Post Graduate Department of Zoology, Khalsa College, Amritsar, Punjab 143005, India

ABSTRACT

The increasing applications of pesticides in the agricultural sector have adversely influenced the flora and fauna of the soil. The variety and quantity of pesticides used per hectare are rising globally, with an increase in the area of soil surfaces. More than 400 types of herbicides are widely used to control the harm of weed for increasing the output and quality of agricultural products. One of the most used herbicides belonging to the sulfonylurea chemical group is metsulfuron-methyl, used to control a large variety of annual grasses and broad-leaved weeds in pre and post-emergence application. Pesticide ecotoxicology is a new branch of toxicology that studies the effects of pesticides on non-target organisms in the soil ecosystem. Earthworm is an important soil biota as well as an important species in ecotoxicological risk evaluation of soil pollution induced by pesticides or other toxins. Earthworm is a ubiquitous animal species that accounts for the majority of soil faunal biomass. The decrease in earthworm abundance in the soil may have an impact on nutrient cycling and their availability for plants. They have been considered as bio-indicators of contamination in the soil and also known to sustain the soils' ecological functions. However, the continuous application of herbicides had caused serious environmental pollution and poses threat to the ecosystem. In the light of above facts, the present study evaluated the tolerance capacity of Eisenia fetida towards herbicide (metsulfuron-methyl) by assessing different parameters like growth and reproduction. In the present study, low concentrations showed less effect on earthworm growth and reproduction and provide valuable information regarding the tolerance of earthworms to metsulfuron-methyl.

Keywords: Earthworm; Ecotoxicology; Herbicides; Metsulfuron-methyl; Pesticides

Effect of germination on nutritional and anti-nutritional components of Adzuki bean

Qurat Ul Eain Hyder Rizvi*, Krishan Kumar, Priyanka Thakur, Divya Chauhan, Naseer Ahmed.

Department of Food Technology, Dr. Khem Singh Gill Akal College of Agriculture, Eternal University, Baru Sahib, Sirmour, HP- 173101

ABSTRACT

Adzuki bean (*Vigna angularis* L.) is the important legume with high protein and amino acid content that makes them a suitable cheap source for fortification of various cereal diets. Adzuki bean is a good source of essential fatty acids, fiber, minerals and phytochemicals such as polyphenols and phytates. The raw grains are rich in vital nutrients but contain some anti-nutritional components. Germination reduced the anti-nutritional factors and increased the bioavailability of macro and micronutrients as well as the level of phytochemicals. In the present study, the adzuki beans were germinated for 72 h and were evaluated for nutritional and anti-nutritional properties at 24, 48, and 72 h intervals. Germination significantly increased the antioxidant potential of the sprouted adzuki beans. The protein content of adzuki bean increased from 19.56 (raw grains) to 23.45% after germination for 72 h. The phenolic content increased from 22.78 mg/g (raw grains) to 25.58 mg/g after germination for 72 h. Similarly, the antioxidant content in adzuki bean increased from 9.74 to 16.67% during germination for 72 h. There was decrease in fat content and values decreased from 3.16 (raw grains) to 1.95% after germination for 72 h. There was reduction in anti-nutritional components of adzuki beans during germination. The phytic acid content of adzuki bean decreased from 6.52 (raw grain) to 3.45 mg/g. Similarly, the tannin content decreased from 6.09 to 3.56 mg/g. Results attained during the study concluded that there was increase in the bioactive components and reduction of anti-nutritional components of the adzuki bean during soaking and germination treatments.

Keywords: adzuki Bean, Nutritional Components, Germination, Bioactive Components

Conservation of natural resources and their management through tribal women participation in protected areas of central India

Protected area contributes to conserve the natural resources present in the forest and tribal women play a crucial role in the sustainable utilization of the natural resources. Protected areas directly conserve the resources or species present in the ecosystem through in-situ conservation. According to IUCN category VI protected area with sustainable use of natural resources contribute mainly to local communities and indigenous people depending on natural resources. We have conducted our research in protected areas of central India. We have studied, reviewed and analyzed various research papers, articles and government data. Therefore analyzing the data tribal women are active participation for natural resource conservation and their involvement could increase effective conservation and management of natural resources in protected areas. In the site where tribal women, SHGs are active the various natural resource can be conserve and manage directly or indirectly. Such efforts of tribal women can conserve and manage the natural resources of protected areas.

RELEVANCE OF CONTRACT FARMING IN AGRICULTURAL DEVELOPMENT

Gargi Paliwal¹; Dr. Amardeep²

Department of Agricultural Communication; Govind Ballabh Pant University of Agriculture & Technology, Pantnagar-263145, Uttarakhand., India

ABSTRACT

Agriculture is the backbone of Indian economy as 65 per cent of Indian population depends directly on agriculture. The major problems faced by farmers like price assurance, product marketability, elimination of intermediaries in the market and timely availability of production credit all this need some strategic interventions. A contract-farming is seen as a promising alternative that obliges a firm to supply inputs, credit, or extension in exchange for an agreement that fixes a price for the product and binds the farmer to follow a particular input and production method. Contract Farming is defined a form of vertical coordination between growers and buyer processors that directly shape production decisions through contract contractually specifying market obligation such as value, volume, quality and at times price, provide specific inputs and exercise some control at the point of production. (Little and Watts, 1994). Contract Farming in India is transforming towards cooperative contract model as reflected by entry of many multinational companies such as ITC Ltd., Cadbury, Global Greens, PepsiCo, etc. In general, Contractual arrangement between parties varies according to the depth and complexity of the provisions in each of the following three areas of Market provision: The grower and buyer agree to terms and conditions for the future sale and purchase of a crop or livestock product, Resource provision: The buyer agrees to supply selected inputs, which includes occasional land preparation and technical advice, Management specifications: The grower agrees to follow recommended production methods, inputs regimes, cultivation and specifications related to harvesting. Government has taken initiatives for Contract Farming which are Model Agricultural Produce Marketing Committee (APMC) Act, 2003 and Farmers (Empowerment and Protection) Agreement on Price Assurance and Farm Services Act, 2020.

3rd International Conference on “Global Initiative in Agricultural, Forestry and Applied Sciences for Food Security, Environmental Safety and Sustainable Development (GIAFAS-2021)”

Keywords: Contract Farming, Initiatives.

Bionomics of South Indian *Callosobruchus chinensis* (L.) on Different Indian Pulses

Devina Seram¹, James Watt Haobijam^{1*}, Senthil Natesan² and John Samuel Kennedy³

¹*School of Agriculture, Lovely Professional University, Punjab, India*

^{2&3}*Centre for Pl. Molecular Biol. & Biotech., Tamil Nadu Agricultural University, Tamil Nadu, India*

ABSTRACT

The pulse beetle, *Callosobruchus chinensis* L. (Coleoptera: Bruchidae) is known to attack pulses, an important nutritional commodity for India. Being a polyphagous pest, it can utilize diverse and alternate host seeds as a source of nourishment for their normal growth and development. In view of this point, this study was aimed to record the bionomics of *C. chinensis* on nine important pulses commonly grown in India, viz. *Vigna radiata*, *V. mungo*, *V. unguiculata*, *Glycine max*, *Cicer arietinum*, *Pisum sativum*, *Phaseolus vulgaris*, *Lens culinaris* and *Cajanus cajan*. The results of present investigations revealed that the oviposition of *C. chinensis* varied on different host pulses. Maximum oviposition was observed on pigeon pea (78 eggs) followed by cowpea (75 eggs) and the least number of eggs was laid on bengal gram (40.67 eggs). Maximum egg hatchability was observed in pigeon pea (91.62%) followed by cowpea (91.11%), green gram (86.09%), kabuli chana (85.52%) and bengal gram (85.04%) and the least was observed in french bean (51.76%). Per cent adult emergence amongst different host pulses was found to be highest in pigeon pea (85.46%) followed by cowpea (82.46%), kabuli chana (76.14%) and green gram (73.09%). Maximum mean developmental period (MDP) of *C. chinensis* was observed in soybean (38.00 days) and the minimum in pigeon pea (29.33 days). Mortality of the adult beetles on different hosts did not differ significantly. The longevity of the offspring differed significantly and the maximum longevity was observed in bengal gram (15.33 days). Amongst different host pulses, the highest per cent weight loss was observed in cowpea (18.70%) followed by pigeon pea (18.32%) and green gram (15.64%) which showed that these pulses are most susceptible to the attack of *C. chinensis*. From this study, it was observed that pigeon pea, cowpea, green gram and kabuli chana were most preferred by the South Indian *C. chinensis* population for their growth and development whereas french bean was the least preferred pulse.

Keywords: seed beetle, Indian pulses, hatchability, adult emergence, mortality, longevity

People should avoid consuming animal products to reduce risk for chronic disease. YES/NO

Seema^{1*} and Vatsala Saharan²

Department of Foods and Nutrition, I.C college of Home science, CCS Haryana Agricultural University, Hisar- 125 004 (Haryana), India

²*SGT University, Gurgaon*

ABSTRACT

Chronic diseases are the leading cause of death worldwide. Ischemic heart disease alone was responsible for about 9.43 million deaths in 2016. However, all cardiovascular diseases together cause around 17.9 million deaths annually worldwide. The prevalence of chronic diseases in the india and around the world is very high and not sustainable by most health care systems. While the etiology is complex, many chronic diseases are preventable through life long practices of adhering to healthy dietary patterns, engaging in physical activity and maintaining acceptable weight. Excessive attention to the animal versus plant binary food choice reflects society’s moral views on eating right. Consumption of animal products exposes humans to saturated fat, cholesterol, lactose, estrogens, and pathogenic microorganisms, while displacing fiber, complex carbohydrates, antioxidants, and other components needed for health. In the process, consumption of animal products increases the risk for cardiovascular disease, cancer, diabetes, obesity, and other disorders. When omnivorous individuals change to a plant-based diet, diet quality as measured by the Alternate Healthy Eating Index improves, and the risk of these health problems diminishes. Many researcher found that vegetarians have a lower prevalence of lifestyle diseases such as Obesity, Diabetes and hypertension than non-vegetarians. Many foods from both animal and plant origin can contain unhealthful components or lead to harmful biological effects, dependent on origin, preparation, dose, and general dietary context. Animal foods may have carcinogenic substances formed during heating (heterocyclic amines), microbial pathogens (*E. coli*), and hormones with untoward effects (estrogen). In conclusion, the complexities of human diets and metabolic health are much too great to allow for a binary categorization as “plants are good, animal foods are bad.” This simplistic approach lacks a foundation in science and cannot meaningfully inform dietary policy. We cannot safely eliminate a major food source, consumed by *Homo sapiens* throughout evolution, and hope to correct the resulting deficiencies with supplemented nutrients.

Keywords: Chronic diseases, Animal products, Supplemented nutrients.

ISOLATION OF VOLATILE OIL CONSTITUENTS AND THEIR ANTIBACTERIAL ACTIVITY OF SKIMMIA LAURIOLA FROM TEHRI GARHWAL

Naveen Kumar

Department of Chemistry, K.L. D.A.V. (PG) College, Roorkee, 247 667 UK, INDIA

ABSTRACT

Aromatic plants have played key roles in the lives of tribal peoples living in the Himalaya by providing products for both food and medicine. The chemical composition of the essential oils of *Skimmia lauriola* (leaves) growing in Northern Garhwal, Himalaya has been studied. The wildy growing plants were collected from Dhanolti region of Tehri Garhwal. Essential oil was extracted by hydro distillation methods and analyzed by GC/MS. Thirty seven components were identified, accounting for 86.33% of the total oil. The oil is mainly composed of linalool acetate (26.40 %), L-linalool (14.18 %), β -phellendrene (9.03 %), prejeijerene (7.06 %), α -terpineol (6.25%), geranyl acetate (3.89 %) and myrcene (2.18 %). The essential oil was evaluated for antibacterial activity. The activity was more pronounced against *Pseudomonas aurens* with 8 mm zone of inhibition followed by *Escherichia coli* with 5 mm inhibition while *Bacillus subtilis* and *Staphylococcus aureginosa* were totally unaffected.

Keywords: *Skimmia lauriola*, Hydrodistillation, β -Phellendrene, Linalool acetate, *Staphylococcus aureginosa*

Yield enhancement of biosurfactant produced by *Meyerozyma guilliermondii* YK32

Dolly Rani* & Seema Sangwan²

Department of Microbiology, CCS Haryana Agricultural University, Hisar, 125004, India

ABSTRACT

Biosurfactants are surface-active compounds produced extracellularly by bacteria, molds and yeasts using sources of biological origin. They have the ability to reduce solid-liquid and liquid-liquid interfacial tension. Biosurfactants are preferred over chemical surfactants for being eco-friendly, non-toxic, biodegradable, in various application including environmental fortification and agriculture. The present work aimed for the production of biosurfactants using different carbon sources i.e. glucose, soybean oil, olive oil, whey and molasses at the rate of 8% $\{(v/v)/(w/v)\}$ using *Meyerozyma guilliermondii* YK32. Biosurfactant production was monitored in terms of oil displacement. *Meyerozyma guilliermondii* YK32 gave highest oil displacement measuring 7.5 cm with 8% olive oil as carbon source, followed by glucose (7.0 cm) and soybean (5.5 cm) after 5 days of incubation. Among industrial wastes/by-products, whey gave better oil displacement equaled to 5.2cm after five days of incubation. For yield enhancement two different hydrophilic industrial wastes (whey and molasses) and hydrophobic substrates (olive oil and soybean oil) were mixed in 1:1 ratio as following treatments: (i.e. 4% olive oil + 4% whey; 4% soybean oil + 4% whey and 4% molasses+ 4% whey) and studied for biosurfactant production after supplementation as carbon source in production broth. Replacement of olive oil, soybean oil and molasses with whey enhanced the biosurfactant production as monitored in terms of oil displacement from 7.5cm. 5.5cm and 4.6cm to 9.0cm, 6.5cm and 6.5cm, respectively, in case of *M. guilliermondii* YK32.

Keywords: Biosurfactant, oil displacement, industrial wastes, hydrophobic substrates, molasses, whey

Rhizodegradation – A promising Organic Phytoremediation technology

Akrati Dev and D.K. Dwivedi

Department of Plant Molecular Biology & Genetic Engineering, Acharya Narendra Deva University of Agriculture & Technology, (Kumarganj), Ayodhya-224229 (U.P.), India

ABSTRACT

Rhizodegradation, also known as phytostimulation or accelerated rhizospheric biodegradation, is the biodegradation of pollutants in the soil by edaphic bacteria that is aided by the rhizosphere's natural characteristics. This region usually has a lot of microbial biomass and, as a result, a lot of microbiological activity, which speeds up the process. In comparison to other soil regions and microfloral communities, this region generally supports high microbial biomass and, as a result, a high degree of microbiological activity, which tends to boost the speed and efficiency of organic substance biodegradation within the rhizosphere. Plant roots have a tendency to improve soil oxygenation in their vicinity and discharge metabolites into the rhizosphere, which contributes to this. The release of sugars, amino acids, and other exudates from the plant, as well as the net root oxygen contribution, are thought to account for up to 20% of annual plant photosynthetic activity, with denitrifying bacteria, *Pseudomonas* spp., and general heterotrophs benefiting the most. Furthermore, mycorrhizae fungi linked with the roots aid in the metabolization of organic pollutants. This is significant because they have unique enzymatic pathways that allow them to biodegrade chemical compounds that would otherwise be impossible to convert purely through bacterial

3rd International Conference on “Global Initiative in Agricultural, Forestry and Applied Sciences for Food Security, Environmental Safety and Sustainable Development (GIAFAS-2021)”

action. Furthermore, mycorrhizae fungi linked with the roots aid in the metabolization of organic pollutants. This is significant because they have unique enzymatic pathways that allow them to biodegrade chemical compounds that would otherwise be impossible to convert purely through bacterial action.

Keywords: Rhizodegradation, biodegradation, rhizosphere,

Statistical analysis of farm Income Diversification among the valley and hill farmers of Manipur

Kh. Rishikanta Singh^{*}, N. Uttam Singh[#] and T. Basanta Singh^{*}

^{*} ICAR Research Complex for NEH Region, Manipur Centre, Imphal

[#] ICAR Research Complex for NEH Region, Umiam, Meghalaya

ABSTRACT

Farm income diversification is a symbolic strategy for income sustenance and safeguard from risk associated with farming. Of the total 16 districts of Manipur state 8 district have been covered in the study comprising of 4 hill districts viz. Churachandpur, Chandel, Tamenglong and Ukhrul districts and another 4 valley districts viz, Imphal West, Imphal East, Thoubal and Bishempur districts. From each district one village was randomly selected and primary data were collected from 240 respondents during the year 2019-20 using questionnaire of which 120 are from hill and another 120 from valley districts with 30 households from each village. Descriptive analysis, Simpson index of Diversification, TOBIT regression analysis using R-Software and Garrett Ranking technique were used in the study. Socio economic analysis of respondent farmers revealed that education level of valley farmers was higher as compared to hill farmers. Of the total respondents, 30.5 per cents were female farmers. Average cultivated area was 0.69 ha for hill area and 0.87 ha for valley area. Activities undertaken by the farmers were classified into two categories viz. farm and non-farm. It was found that the monthly income was higher for valley area which was Rs. 15,932 while for hill area it was Rs.12,110 respectively. For valley area, of the total income earn, farm income constitutes 66 per cent while for hill area it was 51 per cent, the remaining constituted non-farm income. Simpson index of diversification (SID) was used to calculate farm income diversification. The average diversification index was found to be higher for valley farmers which was 42.87 per cent compared to 33.89 per cent for hill farmers. The study revealed that overall there is medium or moderate level of farm income diversification in the state. Hill area has more number of farmers in low SID category compared to valley. Tobit regression analysis revealed that among the nine variables used in the regression only one variable ie, farmers' social category was found to be positively significant at 5 % level. The coefficient of age was negative which reveal that as the age increases, risk bearing ability decreases which leads to decline in level of income diversification. Overall, the study reveal that there is a need for increasing farm income diversification in the state especially in hilly areas by incorporating additional income generating enterprise along with the cultivation of the main crop ie. paddy.

Antifungal activity of some plant extracts against Colletotrichum falcatum causing red rot in sugarcane

Anwar Ahmad¹, Jayant Mandal¹, Ajay Kumar¹ and Sujeet Pratap Singh²

¹Department of Plant Protection, Ch. Charan Singh University, Meerut.

²Uttar Pradesh Council of Sugarcane Research, Shahjahanpur.

ABSTRACT

Out of the many biotic stresses of the sugarcane, the Colletotrichum falcatum Went causes significant reduction in the quality and yield of susceptible sugarcane cultivars. Red rot can affect many commercial varieties during its course of infection and epidemiology. Usually, commercial fungicides are being used for the control of red rot disease which is harmful for human and agro ecosystem. There has been a rising concern on the research plant extracts for control of pest and diseases in agriculture which are less harmful to the human health and environment. Seven plant parts of six plants extracts namely Allium sativum, Azadirachta indica, Allium cepa, Aloe barbadensis miller, Ocimum tenuiflorum and Tinospora cordifolia were taken for the present study. The experiment was conducted as per standard poisoned food technique. Seven plant extracts were utilized to evaluate their comparative fungitoxicity against mycelial growth of Colletotrichum falcatum at various concentration levels of 1, 3, 5, 10, 15, 20, 30 and 60 percent in in vitro condition. Among six plant extracts, the extract of Neem was found more antifungal effects followed by Tulsi and Garlic in present study. These plant extracts could be used for the suppression of Colletotrichum falcatum causing red rot in sugarcane.

Keywords: Sugarcane, Colletotrichum falcatum, Plant Extract, Red Rot, Concentration, Per cent.

Isolation, Identification and Use of Fungus for Plant Growth

Ayushi Negi, Arjit Raj, Poonam Rani and Rohit Gautam

Department of Biotechnology and Microbiology, Meerut Institute of Engineering and Technology, MIET, Meerut.

ABSTRACT

Microorganism for instant bacteria, fungus, are mainly considered as pathogens but some beneficial fungus such as *Trichoderma viride* found ubiquitously and can be used as plant growth promoter to provide defense to plants species from harmful pathogens. *T. viride* powder is selling in market as bio fertilizer and in very much practice these days. Therefore, in present study isolation and identification of *Trichoderma* species was done and bio fertilizer was made for further experimental purpose. For Experimental purpose soil samples were collected in bulk from CCS Biotechnology herbal garden, MIET, Meerut. Then three treatments C, T₅, T₁₀ and T₁₅ in triplicates were prepared. Plant species *Vigna radiate* was selected for experiment as it can easily be grown and maintained. Pre-treated seeds of *V. radiate* were sown in different treatments and seed germination percentage was calculated along with shoot height, root length and vigor index after seed germination where parameters except seed germination percentage were measured and calculated on 3rd, 5th and 7th day. Results showed that seed germination percentage, shoot height, root length and vigor index were high in T₁₀ treatment. On the basis of results it can be concluded that 10 gm *T. viride* in 1 Kg soil is better for the seed germination and growth parameters of *Vigna radiate*.

Key words: *Trichoderma viride*, *Vigna radiate*, seed germination, seed Vigor index, biofertilizer.

Effect of bio-enriched farm yard manure (FYM) on growth, yield and economics of finger millet (*Eleusine coracana* (L.) Gaertn) under dryland condition

Shafnas, I.,¹ Vasanthi, B. G.,² Altaf Kuntoji³ and Thimmegowda, M. N.⁴

Department of Soil Science and Agricultural Chemistry^{1,3} and AICRP for Dry land Agriculture^{2,3} UAS, GKVK Bengaluru- 65 Karnataka

ABSTRACT

Crop suffers from the slow release of nutrients from organic manures at initial stages, which may cause significant reduction in crop yield and farm income. This can be overcome by enrichment of organic manures with beneficial microbial culture and judicious combination of inorganic fertilizers with such enriched organic manures. Finger millet grown at AICRP for dryland Agriculture in reddish brown sandy loam soil during Kharif-2019 to study the effect of bio-enriched FYM viz., nitrogen fixers, phosphorus solubilizers, potassium solubilizers, PGPR and microbial consortia with 60 and 80 per cent RDF on growth, yield and economics of finger millet. Application of bio enriched FYM with microbial consortia + 80 per cent RDF (T₁₀) recorded significantly higher plant height (86.38, 111.52 and 115.33 cm), number of tillers per plant (4.42, 5.20 and 5.42) and dry weight per plant (5.50, 15.05 and 27.27 g) at 60, 90 DAS and at harvest, respectively. Whereas, higher grain yield (2999 kg ha⁻¹) and straw yield (4274 kg ha⁻¹) resulted with T₁₀ treatment, on par with application of 7.5 t ha⁻¹ enriched FYM (microbial consortia)+ 60 % RDF (2905 and 4183 kg ha⁻¹, respectively) and application of bio enriched FYM with microbial consortia + 80 per cent RDF recorded additional return of rupees 12683 per hectare over recommended use of fertilizers. Overall result showed that the bio enrichment of FYM with microbial consortia tended to reduced application rate of chemical fertilizer and thus microbial consortia along with 80 per cent RDF could be recommended for finger millet.

Keywords: Bio-enriched FYM, Dry land, Microbial consortia, Yield attributes

Mutation breeding: An approach for induced variability and genetic improvement in medicinal and aromatic plants

Maneesha Singh

School of Agricultural Sciences, Shri Guru Ram Rai University- Dehradun (U.K) India

ABSTRACT

Variability in the population is pre requisite for any genetic improvement program. Exploiting natural or induced genetic diversity is a proven strategy in the improvement of all major crops, and the use of certain techniques viz., combination breeding, mutagenesis, somaclonal variation and molecular gene transfer to create variation is valuable in medicinal and aromatic plants with restricted genetic variability. Spontaneous and induced mutations in plants contribute for genetic dissection of the wild type genes. Medicinal plants are used for their active principles that influence the physiological processes of an organism; mutation gives rise to a variant with secondary metabolic profile called as chemical races or chromodemes (Lakshman Chandra De, 2017). The widespread use of induced mutants in plant breeding programme across the globe has led to the release of 3222 plant mutant varieties from 170 different plant species in more than 60 countries throughout the world. The developed varieties through this technique can increase biodiversity and provide breeding material

3rd International Conference on “Global Initiative in Agricultural, Forestry and Applied Sciences for Food Security, Environmental Safety and Sustainable Development (GIAFAS-2021)”

for conventional plant breeding thus directly contributing to the conservation and use of plant genetic resource (Raina et al., 2016). According to the

International Atomic Energy Agency (2007), China ranks first with a number of 638 radiation-induced varieties, followed by India with 272 varieties, and Japan with 233 varieties (Nakagawa, 2009). Breeding objectives of medicinal and aromatic plants includes high and stable yield, high content of desire active compounds, resistance to insect pests and diseases as well, tolerant to abiotic stress like moisture stress, high temperature, soil salinity and alkalinity, and absence of harmful substances and also wider adaptability. The potential of induced mutation in plant breeding has long been established. Genetic variability, adaptability and evolution of the species are important for the success of any improvement program. Mutation induction is an important complementary method of breeding of this plant and efficient method to produce heritable changes particularly in case of quantitative traits

such as yield and yield related attributes.

Our endeavor through this study to assess the morphological, cytological and yield contents in medicinal and aromatic plants developed through mutagenesis in India and identify the promising genotypes which will be directly used as new variants.

Keywords: Mutation, catharanthus, mentha, ocimum, alkaloids and essential oil

Adsorption study of acidic and basic dyes of identical molecular weight onto Activated Carbon.

Alka Harit* and Akshay Gautum

H.V.M.(P.G.) College, Raisi, Haridwar, Uttarakhand-247671

ABSTRACT

Purpose - Water is necessary for survival. Dye pollution is a global issue, especially in the textile sector, where huge amounts of dye effluents are emitted during the dyeing process. The goal of this research is to see how well acidic and basic dyes (Acid Orange 7 and Basic Red 2) adsorb onto activated carbon with the same molecular weight. **Methods**- A batch adsorption process is used to remove the dye. Acid Orange 7 and Basic Red 2 dyes (Himedia Pvt. Co., Ltd. and C.D.H. Fine Chemicals Pvt. Ltd respectively) each is used as an adsorbate. Activated carbon (Merck. Ltd. India) believes it has been used as an adsorbent. All tests were performed twice with average values.

Results:- The adsorption capacities of the dyes Acid Orange 7 and Basic Red 2 were determined to be 0.404 and 0.451 mmol/g at 25°C. The experimental data is analyzed by Langmuir isotherm model, and it is in good agreement with the adsorption of Acid Orange 7 and Basic Red 2 on activated carbon at a temperature of 25°C.

Conclusion- Current research shows that activated carbon can effectively remove acidic and basic dyes with the same molecular weight using an adsorption process. The adsorption capacity of Basic Red 2 at 25°C is higher than that of Acid Orange 7. The adsorption in this process conforms to the Langmuir model.

Keywords- Water Pollution, Adsorption, Dyes, Activated carbon.

Record on egg parasitoids of the family Trichogrammatidae (Hymenoptera: Chalcidoidea) from Chhattisgarh, India

¹Mohsin Ikram *, ²Rajendra Prasad, ³Mahipal Singh, ⁴Salman Khan, ⁵Manendra Kaneria, ⁶Manish Kaneria

^{1,2,3} School of Agriculture, Uttaranchal University, Dehradun (UK) India

⁴ Forest Survey of India, Central Zone, Nagpur (Maharashtra)

*^{5,6} Forest Entomology Discipline, Forest Protection Division
Forest Research Institute, New Forest, Dehradun (UK)India,*

ABSTRACT

Trichogrammatid egg parasitoids are very minute, generally less than a half millimetre and these are parasitizing various insect pests mostly belonging to insect orders Lepidoptera, Hemiptera and a few to Coleoptera, Diptera and Thysanoptera. Parasitoids of Trichogrammatid genera: Aphelinoidea, Paracentrobia and Ufens commonly parasitize the Hemipteran eggs on of cash crops, orchards, as well as forest tree species. Trichogrammatids are universally accepted bio-control agents of lepidopterous pests of agricultural and forestry importance. They are very important and well accepted in biological control of insect pests. Several species of the genus Trichogramma have been used in applied biological control of insect pests.

During the present survey (February-March and October-November 2017), several trichogrammatids have been collected from forestry and agro forestry areas of Chhattisgarh, India. Present paper includes a brief account of 10 species of trichogrammatid (Aphelinoidea gwaliorensis, Lathromeroidea ajmerensis, Oligosita debaiensis, Oligosita gilvus, Pseudoligosita nephotticum, Oligosita novisanguinea, Oligosita sanguinea, Paracentrobia magniclavata, Ufens gurgaonensis and Ufens jaipurensis), which are recorded as indigenous egg parasitoids. These are widely distributed in Chhattisgarh.

3rd International Conference on “Global Initiative in Agricultural, Forestry and Applied Sciences for Food Security, Environmental Safety and Sustainable Development (GIAFAS-2021)”

Keywords: Hymenoptera, Trichogrammatidae, Egg parasitoids, Biological control.

In-silico assessment of Biphenyl Dioxygenase activity from *Pandoraea Pnomenusa* B-356 with different PCBs congeners

Neha Singh 1 , Vikram Dalal 2 , Pravindra Kumar 3

Department of Zoology, Harsh Vidya Mandir (P.G.) College, Raisi, Haridwar, India

Department of Anaesthesiology, Washington University, Saint Louis, Missouri, USA

Department of Biotechnology, Indian Institute of Technology Roorkee, Roorkee, India

ABSTRACT

Polychlorinated biphenyls (PCBs) are ubiquitous xenobiotic compounds which are organic chemicals having carbon, hydrogen and chlorine atoms. The number and location of chlorine atoms in a PCB congener determines many of its physical and chemical properties. Polychlorinated biphenyls (PCBs) are among the most persistent chlorinated environmental pollutants, despite the long-term regulation related to their manufacturing protocols and usage. The discovery of many bacterial strains that are partially able to degrade PCBs has fuelled research directed towards the improvement of bioremediation-based strategies for the clean-up of PCB contaminated sites. Present work describes the screening of polychlorinated biphenyl (PCB) library with native Biphenyl dioxygenase (BPDO) structure from *Pandoraea pnomenusa* B-356, in order to evaluate the influence of the pattern and degree of chlorination on the catalytic activity of BPDO. Therefore, for that purpose, PCB congener library of 209 congeners was made and screened to elucidate the enhanced degradation abilities of BPDO. Through docking studies, the binding ability of BPDO from *Pandoraea pnomenusa* B-356 w.r.t. PCB congeners was measured and important active site residues involved in the interaction were also acknowledged. Moreover, results related to the particular geometry and electrostatic properties of chlorinated biphenyls can be useful to rationalize their specific and selective toxicities.

Keywords: Polychlorinated biphenyls, screening, geometry and electrostatic properties

Abbreviations used: PCBs- Polychlorinated biphenyls, BPDO- Biphenyl dioxygenase

Effect of cultivars, environment and their interactions on growth and yield of tomato (*Solanum lycopersicum* L.)

Mukesh Kumar, Durvesh Kumar Singh and Dinesh Kumar Singh

Department of Vegetable Science, GBPUA & T Pantnagar, U.S. Nagar, Uttarakhand, India

ABSTRACT

A field experiment was conducted at Vegetable Research Centre, G.B. Pant University of Agriculture and Technology Pantnagar, U.S. Nagar Uttarakhand, during winter season of 2016- 17 to study performance in and outside of poly-house to find out the most suitable and best cultivar, environment and interactions for growth, yield and quality of tomato fruits. The experiment was laid out in factorial randomized block design (R.B.D.) with three replications. Each replication consisted of eight treatment combinations viz. two tomato cultivars i.e. Pant Poly-house Tomato-2 (V1) and Pant Poly-house Hybrid Tomato -1 (V2), four environments (viz. E4- poly-house + spray of 2, 4-D), E3 (open + spray of 2, 4-D), E2 (poly-house without spray) and E1 (open field without spray). Foliar spray of 2, 4-D @ 5 ppm concentration was applied as whole plant spray at 30, 45 and 60 days after transplanting of tomato seedlings. The cultivar V1 produced highest fruit yield of 648.52 q/ha which was 12.13% higher over V2. Among the environment (treatment) E4 produced greater fruit yield (1009.79 q/ha) followed by E3 (606.85 q/ha) and E2 (565.26 q/ha). The treatment E4 produced 66.39% higher fruit yield over treatment E3, 78.64% higher fruit yield (q/ha) over E2 and 271.39% higher fruit yield over treatment E1, respectively. Whereas, treatment E3 gave 7.36% higher over E2 and 123.19% over treatment E1, respectively. Similarly, treatment E2 produced 107.90% greater fruit yield over E1 (271.89 q/ha). Among the interactions, treatment V1E4 performed better for 10 characters whereas, V2E4 was better for 3 characters, V2E3 for 3 characters and treatment V1E2 only for one character as compared to rest of the interactions. The treatment V1E4 gave 37.75% higher fruit yield than V2E4 and 84.44% over treatment V2E3 and 119.67% over V1E2. On the other hand, V2E4 produced 42.09% higher over V2E2 and 266.52% higher fruit yield over V2E1. Treatment V2E4 gave 33.89% higher over V2E3.

Keywords: Cultivars, Environment, Interactions, Foliar spray, Tomato

WEED DYNAMICS AND ITS MANAGEMENT UNDER DIFFERENT FERTILITY LEVELS WHEAT (*Triticum aestivum*) IN DOON VALLEY CONDITIONS

Sachin Kumar, Roop Kishore Sharma and Moinuddin*

*Doon (P.G) College of Agriculture Science and Technology- Dehradun, Uttarakhand, India
School of Agricultural Sciences, Shri Guru Ram Rai University- Dehradun, Uttarakhand, India*

ABSTRACT

A field experiment was conducted at Crop Research Farm, Rampur-Dehradun, Uttarakhand in 2010- 2021 rabi season to study the entitled “Weed dynamics and its management under different fertility levels a wheat (*Triticum aestivum*) under Doon valley conditions” the crop variety “HD-303 with randomized block design and three replications comprising seven treatments including weed check, hand weeding and herbicide like: Sulfosulfuron 25 WP@25gm/ha, Pendimethalin 35 EC @ 0.75kg/ha, were used. The crop was infested with *Chenopodium album*, *Viciasativa*, *Medicago denttculata* ,*Phalaris minor*, *Cynodon dactylon*, among broad and narrow leaved weeds. From the experimental analysis showed tha hand weeding at 20, 40, 60 and 80 DAS followed by (3490 kg/ha) in T 3 Sulfosulfuron 50 WP @25gm/ha due to less competition of weeds. The result indicated that as manual method of weed control established it superiority over rest of the herbicides but from the economical point of view due to their costly weed control, among the chemicals control Sulfosulfuron 50 WP@25gm/ha followed by Pendimethalin 35EC @ 0.75kg/ha is best because higher crop with lowest cost of cultivation.

Keywords: Herbicide, variety- HD-3036, weed and wheat

Role of systemic and contact insecticides for the management of Sal seed and seedling borer *Pammene theristis* Meyrick (Lepidoptera: Tortricidae)

Manisha Sharma 1 , K.P. Singh 1 and Mohammad Faisal*

*Forest Protection Division, Forest Research Institute, Dehradun
Himgiri Zee University, Dehradun*

ABSTRACT

In India, Sal forests are spread over 10 million hectare and are one of the most important timber species of the Indian sub-continent. *Pammene theristis* Meyrick (Lepidoptera: Tortricidae) is a major Sal seed and seedling borer closely associated with the dying off of new sal generation. In the present work, an attempt has been made to work out the possible control measures in respect of the target insect species *P. theristis*, to provide protection by use of appropriate doses/ concentrations of chemical insecticides. On the qualitative observation records of systemic insecticides, it was observed that maximum percentage of control of the Sal seedling borer was obtained by dimethoate at optimum concentration followed by monocrotophos and imidacloprid at the same concentration. Contact insecticides were used as a prophylactic treatment and maximum percentage of control of the Sal seedling borer was obtained by chloropyriphos at optimum concentration followed by cypermethrin and deltamethrin at the same concentration. Statistical analysis (ANOVA) showed that larval mortality was found to be highly significant among all treatments when compared with control.

Keywords: Sal, *Pammene theristis*, Systemic insecticides, Contact insecticide

Innovative Approach in Agriculture and Allied Sciences Nano-chitosan, a biosmart molecule in sustainable agriculture.

Harshita Mali*, Surbhi Prithyani and Pratibha

Department of Horticulture, Rajasthan College of Agriculture- MPUAT, Udaipur (Raj. 313001), India

ABSTRACT

In the current scenario of climate change and rising hunger index, it is an urgent requirement to satisfy the nutritional demands of the rapidly growing global population. Using conventional farming, nearly one third of crops get damaged, mainly due to pest infestation, microbial attacks, natural disasters poor soil quality, and lesser nutrient availability. Additionally, by 2050, around 50% of agricultural lands are predicted to be affected by salinity that can negatively affect plant growth and worsen the nutritional security worldwide. In the light of this, nanoparticles are proving a new-age material to transform modern agricultural practices in a sustainable way. As nanotechnology has evolved, researchers have incorporated chitosan-based nanomaterials in a variety of products to enhance their efficacy and alleviating various biotic and abiotic stresses involved in crop production. Chitosan has emerged as a biodegradable, nontoxic polymer with multiple beneficial applications in the agricultural and biomedical sectors. Chitosan is a linear copolymer (with D–glucosamine

3rd International Conference on “Global Initiative in Agricultural, Forestry and Applied Sciences for Food Security, Environmental Safety and Sustainable Development (GIAFAS-2021)”

and N-acetyl-D-glucosamine units joined via β -(1-4) glycosidic bonds) obtained from a variety of sources by deacetylation of chitin and contains more than 7% nitrogen and less than 40% degree of acetylation. Although the primary commercial production source for chitosan is crustacean shells. Additionally, chitinous cell wall material has also been isolated from yeast species *Rhodospiridium paludigenum* and *Saccharomyces cerevisiae*, fungal mycelium of *Allomyces arbuscula*, *Mucor genevensis*, *Tranetes versicolor*, and the fruiting body of *Agaricus bisporus*. These fungal alternatives are more cost-effective and renewable sources for chitin as compared to crustacean shells to obtain chitosan. Chitosan has been popular due to its antimicrobial, antioxidant, and chelating properties, together with its nontoxic and biocompatible nature. Nano-chitosan based materials or chitosan combined with other nanoparticles have been used to preserve fresh fruits such as strawberries, jujube, loquat, banana and longan during storage. A popular method to prevent fast ripening of the fruits is using edible coating and chitosan is one best option. Besides this, the edible coating can be used as a media to incorporate active substances, such as antimicrobial agents, antioxidants, enzymes or probiotics, and vitamin formation to increase nutrient content of food. In some advanced

wastewater treatments, chitosan nanoparticles have been embodied into ultrafiltration and nanofiltration membranes to reduce chemical oxygen demands, colour, metal ions, and to enhance the antifouling properties. Solid matrix priming of seedlings with nanochitosan has shown to reduce the harmful effects of salinity stress and improve metabolism, growth, protein levels, and chlorophyll content in the plants. Chitosan-polyvinyl alcohol hydrogels with and without copper nanoparticles applied to tomato plants under salt stress were shown to promote the plant growth and elevate the expression of genes for the production of jasmonic acid and superoxide dismutase which are necessary for detoxification. Application of chitosane nanocoating on fruits has shown inhibition in germination process of *C. gloeosporioides* demonstrating its fungicide potential. Another application of nanoparticles composed of chitosan is to enhance the solubility, stability, and cellular uptake of antioxidant compounds, increasing their applications in the food and pharmaceutical industries. The in-depth study of plant and chitosane based nanomaterial interactions opens new avenues toward improving crop practices through increased properties such as disease resistance, crop yield, and nutrient utilization in a sustainable way. Although chitosan is known to be relatively nontoxic but when formulated into nanoparticles and incorporated with other compounds such as metals can prove

environmental and health risk during the usage. Therefore, more work is yet to be done for a better understanding of the mechanism of action of nanomaterials related to agricultural and biomedical fields while obtaining the highest benefits for human with minimum damage to the environment.

Keywords: biodegradable, chitosan, food-security, nanoparticle, sustainable

Mulching Practices: A Boon for Horticulture Sector

Techi Goven Tara, Suneeta Singh, Anil Kumar Saxena and Moinuddin

School of Agricultural Sciences, Shri Guru Ram Rai University Dehradun, Uttarakhand India

ABSTRACT

Word mulch has been derived from the German word “Molsch” means “easy to decay” and mulches have widely been used for horticulture crops such as fruits, flowers and vegetable production since ancient times. Mulching is referred as spreading various covering materials on the surface of soil to minimize moisture losses, weed population and to enhance crop yield. It is nothing but the process of covering top of the soil surface with loose extraneous matter. Mulches are of two types- Organic and inorganic. Organic mulches include grass, crop stump, straw, bark chips, compost, manure, saw dust, wooden pieces, rice husk, onion garlic scales and leaf litter, etc. Whereas plastic film, metal foil, sand, gravel, stone, etc. constitute inorganic mulches. The Purpose of mulching in Horticulture field for conservation of soil moisture, regulation of soil temperature, suppression of weed growth, prevention of soil erosion, control of pest and disease etc. Mulching also improves the aesthetic value of landscapes and economic value of crops. There are contradiction about mulching materials as some researchers favor mulches as some others have denoted concerns. The selection of mulching material is important with respect to crop type, management practices and climatic conditions. The appropriate mulching technique could provide benefits to the agro-ecological systems. Therefore, the impacts of low-cost, eco-friendly and biodegradable mulching materials on soil microbes, nutrient balance, plant growth and soil erosion should be explored in the future.

Keywords: Molsch, organic mulches, inorganic mulches, aesthetic, biodegradable

3rd International Conference on “Global Initiative in Agricultural, Forestry and Applied Sciences for Food Security, Environmental Safety and Sustainable Development (GIAFAS-2021)”

Role of rural youth in decision making related farming system in Fatehpur district of Uttar Pradesh

Alimul Islam* and Moinuddin**

Department of Agricultural Extension & Communication Sam Higginbottom University of Agriculture Technology and Sciences, Prayagraj (U.P) India

School of Agricultural Sciences, Shri Guru Ram Rai University- Dehradun (U.K)India

ABSTRACT

The involvement of youth in agriculture is vital as they may be more energetic, effective and receptive to new ideas and advanced technologies. A study was conducted in the district of Fatehpur, Uttar Pradesh state, Out of thirteen development blocks five blocks was selected purposively in the district, and three villages were selected randomly from each blocks. From each selected village Eight rural youth were selected randomly for data collection. The total sample size of the study was 120 rural youth farmers of Fatehpur district. A structured interview schedule was used to collect the data, collected data were analyze and interpreted in the light of the objective by using appropriate statistical tool to draw logical conclusion. The study revealed that 65.42 per cent of rural youth farmers had medium level of decision making while participation in Agricultural practices. Age and size of family had not-significant relationship with decision making of rural youth in Agricultural practices. Innovativeness, attitude and sources of information had positive and highly significant relationship with decision making of rural youth in agricultural practices.

Keywords: Agricultural Practices, Decision making, Participation, Rural youth.

Sericulture Industry in India—An overview

Bamang Siku, Suneeta Singh, Anil Kumar Saxena and Moinuddin

School of Agricultural Sciences, SGRR University, Dehradun- 248001, Uttarakhand INDIA

ABSTRACT

Sericulture is defined as the art of commercial production of silk through rearing of silkworm. It is an agro based and labour oriented industry. About its history there is no authentic information available but there are two views: according to that some people, India is the originator of sericulture industry however for others China is the originator. Therefore, 2nd view is of greater acceptance. Silk expert and silk trade lead to the development of silk route. Pebrinedisease (epidemic disease) broke and wipeout sericulture industry during 19th century. Currently India stands fifth in the production of silk. Also India accounts for little over 5% of the total global output of mulberry raw silk and 10% of the tasar silk. Major silk producer states are Mysore, West Bengal, J&K Assam, Bihar, TN, Manipur and Tripura. Total 29 countries in the world are practicing sericulture. India produces four kinds of silk: Mulberry *Bombyxmori*, Tasar *Antheraepaphia*, Muga *Antheraeaassama* and Eri silkworms *Philosamiarecini*. Silkworms are the larvae or caterpillar of domesticated silkworm, economically important & serigenous insects. *Bombyxmori* is fed on mulberry plant *Morusalba*. Leaves of mulberry tree are cultivated in plantations. Other than mulberry leaves these insects can be feed Ber, Oak, Sal, Fig and Arand. MUGA SILK is the most costliest and Lustrous silk available in the world. All the four species benefit the man in India. Other than silk it is also suitable for small & marginal farmers with small investment but higher returns. No sophisticated machineries needed. Ideal for dry & unused lands. Ideal occupation for weaker sections, helping employment opportunities, 60% of the employment are women. By products & benefits are fruit, medicine, fuel wood, timber, fodder, soil conservation, pupae cakes in poultry/fisheries. Overall SERICULTURE industry is an eco friendly concept.

Keywords: Ber, Eri Silk, Oak, Poultry, Sericulture, Tasar Silk

Frontline Demonstration of Paddy Drum Seeder (8 Row) under Well Irrigated Rice in Nalgonda District, Telangana State, India

T.Bharath*1, M.A.Aariff Khan1, M.Shankar1, M.Shankaraiah1, and S.Pallavi1

Krishi Vigyan Kendra, Kampasagar, Nalgonda District-507208, Telangana State

Professor Jayashankar Telangana State Agricultural University

ABSTRACT

Frontline demonstration was conducted to popularize the drum seeder among the farmers, feasibility of paddy sowing by drum seeder implement was done with the assistance of Krishi Vigyan Kendra, Kampasagar, Nalgonda under Professor Jayashankar Telangana State Agricultural University, Telangana for consequently three years in Kharif, from 2018-19 to

3rd International Conference on “Global Initiative in Agricultural, Forestry and Applied Sciences for Food Security, Environmental Safety and Sustainable Development (GIAFAS-2021)”

2020-21. The comparison was made between direct sowing of paddy using drum seeder and traditional transplanting of farmers practice with an objective to reduce the cost of cultivation of paddy and subsequently to increase the returns. The demonstrations revealed more number of tillers (395/m²) and panicles (370/m²) in direct sowing by drum seeder compared to farmers practice (365 and 346/m²). Direct sowing by drum seeder influenced more plant height (68.2cm), number of tillers/m² (395) and yield attributing parameters such as number of panicles (370/m²), Panicle length (16.9 cm) and number of grains/panicle (182). Direct sowing of paddy by drum seeder recorded higher grain yield (6512 kg/ha) which was 6.4 per cent over farmers practice (6094 kg/ha) with net saving Rs.10500.00 on cost of cultivation/ha. The Gross returns and net returns (Rs.1,20,795 and Rs.68,516/ha) by drum seeder method was more compared to farmers practice (Rs.1,13,036/ha and Rs.58,016/ha). Drum seeder method saved the cost of cultivation by 5.1 per cent whereas, gross returns and net returns were increased by 6.4 and 15.3 per cent respectively over farmers practice. Seed rate also reduced to 30.0 kg ha⁻¹ as against farmers practice (64.5 kg/ha). Direct sowing with drum seeder reduced the cost of nursery raising, transplanting and cost of cultivation besides increasing yield by 5.0 per cent. The crop attained to early harvest 10 days before duration which minimize the water and pest management at harvest stage.

INSECTS BIO-DIVERSITY AND ITS CONSERVATION

Mohammad Faisal, Sharad Pandey and Moinuddin*

Department of Agriculture, Himgiri Zee University, Dehradun, Uttarakhand, India

**Shri Guru Ram Rai University Dehradun, Uttarakhand, India*

Insects comprise the largest group of organisms making up more than 58% of the known global biodiversity. The members of class Insecta are arranged in 29 orders. Insects are important because of their diversity, ecological role and influence on agriculture, human health and natural resources. They inhabit all habitat types and play major roles in the function and stability of terrestrial and aquatic ecosystems. Insects are involved in various vital ‘ecosystem services’ such as pollination, decomposition, herbivory and biological control as well as contributing directly to human-based economies through silk, lac and honey production (silkworm, lac insects and honey bee).

The world is currently facing its greatest ever biodiversity crisis. The incredible rate of decline in species diversity of insects dictates that enormous resources be directed to the problem as rapidly as possible so that they can be collected preserved and studied before they are driven to extinction. Insects should be collected and preserved in museums and national depositories so as to make these available to other taxonomists. In the present context biodiversity is in great focus. All the signatories of the Convention on Biological Diversity are required to inventory their biological resources. But whatever biodiversity is collected for inventorisation, environmental monitoring, conservation, preservation, commercial use, etc., by environmentalists, ecologists, or other specialists, the first and foremost requirement is the identification and providing scientific names to the species collected which is the job of taxonomists. Only after identification, knowledge gathered on the species by researchers worldwide could be retrieved and used for the benefits of mankind.

Keywords: Insect, Biodiversity, Conservation

Response of Sweet william (*Dianthus barbatus*) to salicylic acid under moisture stress

Rifat Ramzan, F. A. Khan, F. U. Khan, S. A. Bhat, S. A. Mir, Moinuddin, Sabah A. Dar and Manoj Kumar Prajapati+

Sher-e-Kashmir University of Agricultural Sciences and technology of Kashmir, Shalimar, Distt. Srinagar (J&K); #Shri Guru Ram Rai University, Dehradun (Uttarakhand), India; +Janata Maha Vidyala, Ajeetmal (Auraiya), U.P.

ABSTRACT

The study was carried out in complete randomized design (CRD) during 2019 - 2020 at the Division of Basic Sciences and Humanities, Faculty of Horticulture, SKUAST-K, Shalimar to find out the deviations in morpho- physiological and biochemical attributes of sweet Willium (*Dianthus barbatus*) under the influence of soil moisture stress and salicylic acid. Healthy and uniform seedlings of sweet Willium obtained from the division of FLA and were transplanted in 12 inch plastic pots with four replications. Observation on plant growth, leaf water status photosynthetic pigments, membrane integrity and antioxidant potential, accumulation of osmolytes and nitrate reductase activity were recorded. Moisture stress decreased the plant height, leaf area, shoot dry weight and root dry weight from 50.69 to 39.04 cm, 12.86 to 10.72cm², 3.83 to 3.25g/plant and 0.97 to 0.56g/plant, respectively. Application of salicylic acid @ 20µM increased the plant height, leaf area, shoot dry weight and root dry weight from 37.69, 8.91, 2.95 and 0.35 to 51.68cm, 14.18cm², 4.21g/plant and 1.11g/plant, respectively. Likewise, chlorophyll a, chlorophyll b, total chlorophyll and carotenoid content also decreased with increase in moisture stress with absolute values of 0.63, 0.24, 1.00 and 0.18 mg.g⁻¹ of fresh weight at 25% field capacity as compared to 0.78, 0.31, 0.90 and 0.24 mg/g fresh weight at 50% field capacity, respectively. There were 11 and 14 percent of reduction in CSI at 50 and 25 percent of field capacity, respectively. Membrane integrity was also affected due to moisture stress. Cell

3rd International Conference on “Global Initiative in Agricultural, Forestry and Applied Sciences for Food Security, Environmental Safety and Sustainable Development (GIAFAS-2021)”

membrane stability index decreased from 55.07 to 47.73% as moisture stress increased from 100 to 25% of field capacity and 20 μM salicylic acid application increased cell membrane stability index by 25%. Nitrate reductase activity decreased from 4.01 to 2.98 $\mu\text{g/g/hr}$ and increased from 2.23 to 5.16 $\mu\text{g/g/hr}$ by application of 20 μM salicylic acid. Proline content increased by 37% on increasing moisture stress from 100 to 25 % field capacity and application of salicylic acid of 20 μM increased proline content by 39%. The extent of increase in total sugar content in the present study varied from 19% and 28% under 50 and 25 percent of field capacity. The decrease in number of flowers, individual flower weight and diameter of flower at 50 and 25 percent of FC was obtained as 7 and 8 %, 6 and 19 % and 7 and 15%, respectively. Also from the experiment foliar application of salicylic acid proved better mode of application as compared to seedling root dip method.

Keywords: Antioxidant potential, field capacity, flower quality, membrane integrity, proline accumulation, salicylic acid

Alleviation of low temperature induced damage by exogenous application of melatonin in French bean (*Phaseolus vulgaris* L.)

Sabah A. Dar, F. A. Khan, S. Narayan, F. U. Khan, S. A. Bhat, S. A. Mir, Moinuddin, Rifat Ramzan and Manoj Kumar Prajapati+

Sher-e-Kashmir University of Agricultural Sciences and technology of Kashmir, Shalimar, Distt. Srinagar (J&K); #Shri Guru Ram Rai University, Dehradun (Uttarakhand), India; ; +Janata Maha Vidyala, Ajeetmal (Auraiya), U.P.

ABSTRACT

The present investigation entitled “Alleviation of low temperature induced damage by exogenous application of melatonin in French bean (*Phaseolus Vulgaris*)” was carried out at the division of Basic Sciences and Humanities, Faculty of Horticulture at SKUAST-K in complete randomized design (CRD) with three replications. French bean seeds were sown in plastic pots of 6 inch sizes during the year 2020. Application of melatonin with 0ppm, 100 and 200 μM was given as seed priming and foliar application methods. Foliar application of melatonin was done at 3-leaf stage. After one week of foliar application plant were exposed to 10 and 15°C temperatures in two different growth chambers. After one week of exposure, plants were again brought to the ambient temperature. Observations recorded on different attributes indicated that low temperature stress significantly reduced the leaf area, leaf water status, photosynthetic pigments MSI, pollen viability, pollen germination and seed set. The decline in these attributes were more pronounced at 10 °C than 15 °C temperature. However, low temperatures resulted in increased leaf antioxidant, MDA, sugar as well as protein content MDA contents and MII with more severity at 10 °C than 15 °C temperature. Application of melatonin was found to increase the leaf area, leaf water status, photosynthetic pigments, MSI, pollen viability, pollen germination and seed set levels. Exogenous application of melatonin was found to further increase in leaf antioxidants, sugar and protein contents. However, there were significant decreases observed in leaf MDA and thus MII due to the application of melatonin. Further, higher concentration of melatonin (200 μM) was found more effective in altering these attribute compared to lower level of melatonin (100 μM). Study further, indicated that foliar application of melatonin was more effective method of melatonin application than seed priming method.

Keywords: Antioxidant, low temperature stress, melatonin, seed priming, foliar spray

Evaluation of tomato (*Lycopersicum esculentum* Mill.) genotypes for plant growth, fruit yield and quality

Hilal A. Bhat, F. A. Khan, Zaffar M. Dar, S. Narayan, S. A. Mir, A. A. Malik, S. A. lone, Sehrish sajad, Urfia jan and Manoj Kumar Prajapati+

Sher-e-Kashmir University of Agricultural Sciences and technology of Kashmir, Shalimar, Distt. Srinagar (J&K); #Shri Guru Ram Rai University, Dehradun (Uttarakhand), India; +Janata Maha Vidyala, Ajeetmal (Auraiya), U.P.

ABSTRACT

The study was carried out with different tomato genotypes during 2018 and 2019 at Division of Basic Sciences and Humanities (SKUAST-K) to assess the plant growth and fruit growth with quality characters and mineral composition of twelve genotypes of tomato. Healthy and uniform seedlings of tomato genotypes obtained from the Division of Vegetable Science and were transplanted in pots with four replications. The observation like leaf area, fruit growth, quality characters and mineral composition were recorded as per the standard procedure. Among different genotypes 2016/TODVAR-9 (G8) recorded the highest leaf area (713.6cm²), fruit yield (1.77kg/plant) and showed better fruit quality in terms of TSS (4.35%), titrable acidity (1.2%), vitamin C (36.18mg/100g), lycopene (6.84mg/100g) and carotenoid (8.28mg/100g) contents. The maximum P (0.83%), K (2.35%), Mg (0.52%) and Ca (0.23%) contents was recorded in G8 genotype among all the genotypes. Regression analysis of the data showed a strong correlation between leaf area and fruit yield ($r = 0.86^{**}$), leaf area and fruit sugar content ($r = 0.60^{*}$), PLW and fruit Ca content ($r = -0.97^{**}$), fruit Ca content and storage life ($r = 0.97^{**}$) and fruit PLW and storage life ($r = -0.98^{**}$).

Keywords: Tomato, leaf area, fruit yield, vitamin C, mineral content.

Quality and shelf life of kiwifruit (*Actinidia deliciosa* A chevalier) as influenced by certain post-harvest treatments

Mohammad Younus Mir, Farooq Ahmad Khan, Moinuddin Manoj Kumar Prajapati+

Sher-e-Kashmir University of Agricultural Sciences and Technology of Kashmir, Shalimar – 190025, Distt. – Srinagar (J&K) INDIA;

**Shri Guru Ram Rai University, Dehradun (Uttarakhand), INDIA; +Janata Maha Vidyala, Ajeetmal (Auraiya), U.P.*

ABSTRACT

Investigations were undertaken at the division of Post Harvest Technology, SKUAST-Kashmir to monitor the periodic changes in quality characters during storage and assess the effectiveness of CaCl₂ dip and wax coating treatments in extending the shelf life and maintaining the physico-chemical quality of kiwifruits. Physiologically matured Hayward and Allison cultivars of kiwifruit were obtained from the orchard of the university and pre-cooled at 0°C. Fruits were dipped in aqueous solutions of 2, 4 and 6% CaCl₂ and 4, 8 and 12% Shellac wax for 15 minutes and 20 seconds, respectively. Fruits without any treatment were served as control. After air drying, the fruits were packed in cardboard boxes and stored under ambient conditions in the laboratory. The experiment was designed in CRD (factorial) with three replications wherein each replication comprised of 15 fruits. Physico-chemical analysis of fruits was carried out at 0, 15, 30 and 45 days after storage (DAS). There was a gradual infirming changes in all the common physico-chemical quality attributes of fruits during storage, except a sharp decrease in fruit firmness was a matter of fact, particularly at 15DAS (8.7 to 2.44kg/cm²). On the other hand, storage period did not influence mineral composition (N, P, K, Ca, Fe and Zn) of the fruit. Analysis of the data revealed that cultivar Hayward showed a better storage performance with a shelf life of ≈30 days as compared to Allison with a shelf life of ≈15 days. Both, CaCl₂ dip and Shellac wax coating resulted in a significant improvement in physico-chemical quality attributes and storage behavior of kiwifruit under ambient storage condition. Post-harvest dip of fruits with CaCl₂ (4%) proved most effective treatment which resulted in an extended shelf life with improved values of fruit firmness (4.04kg/cm²), TSS (13.13°B), acidity (1.44%), ascorbic acid (66.45mg/100g), PLW (4.06%) and organoleptic rating (3.82/4.00) at 15 DAS followed by surface coating with Shellac wax (8%) as compared to control. Data indicated that shelf life of Allison and Hayward kiwifruits can be extended from <15 days to >15 days and <30 days to >30 days, respectively by post-harvest dip of fruits in CaCl₂ (4%). These treatments (CaCl₂-4% dip and Shellac wax-8% coating) also proved instrumental in reducing the flesh white patch and pericarp translucence disorders in kiwifruit. However, higher concentration of CaCl₂ (6%) and Shellac wax coating (12%) resulted in surface pitting and bulging of kiwifruits.

Keywords: Kiwifruit, calcium chloride, shellac wax, shelf life

Effect of seed soaking and priming methods on physiological potential of seed germination in okra (*Abelmoschus esculentus* L.)

Fasil Fayaz, F. A. Khan, S. Narayan, S. M. zargar, S. A. Bhat, S. A. Mir and Moinuddin

Sher-e-Kashmir University of Agricultural Sciences and technology of Kashmir, Shalimar, Distt. Srinagar (J&K); #Shri Guru Ram Rai University, Dehradun (Uttarakhand), India

ABSTRACT

Okra is a tall annual herb with heart shaped leaves and yellow, hibiscus-like flowers cultivated for its immature fruits (seed pods). The seed pods are 3 - 10 inches long, tapering, usually with ribs down its length. These tender, unripe seed pods are used as a vegetable, and have a unique texture and sweet flavor. The pods, when cut, exude a mucilaginous juice that is used to thicken stews and have a flavor somewhat like a cross between asparagus and eggplant. Okra is cooked with meat for flavoring and because of high mucilaginous content, the fruits are ideal for both thickening and flavoring stews and soups. The fruits can also be boiled or fried and eaten as a vegetable. Soaking of seeds in water or solutions of different chemicals has been proved beneficial in improving the seed vigour, germination and seedling growth and yield in okra. In the same way, seed priming has also been proved as an efficient tool for synchronization of germination and increasing seed vigor and growth of seedlings, especially under stressful conditions. Reported works indicated that pre-sowing seed treatment both as soaking and priming as well were able to improve seed germination potential, crop growth and stand which finally resulted in improved yield and quality of vegetables. However, effectiveness of these treatments depends on the concentration of priming agents and priming durations. Further, no information are available with regard to comparative effectiveness of one pre-sowing seed treatment to other. Taking into considerations the above facts present study will be conducted on okra to evaluate the different seed soaking and priming treatments for improving seed germination properties with the specific

3rd International Conference on “Global Initiative in Agricultural, Forestry and Applied Sciences for Food Security, Environmental Safety and Sustainable Development (GIAFAS-2021)”

objectives of improving the seed vigour and germination potential in okra. The experiment was conducted during the year 2020-21 and results have been discussed in details.

STUDIES ON INSECT PESTS OF APPLE IN KASHMIR AND ITS INTEGRATED MANAGEMENT APPROACHES

Shabir Davood Wani^{1,*}, Mohd Majid Jamali¹, Moinuddin² & Rayees Afzal Mir¹

School of Agricultural Sciences, Glocal University, Saharanpur, Uttar Pradesh, India

School of Agricultural Sciences, Shri Guru Ram Rai University- Dehradun, Uttarakhand, India

ABSTRACT

The present study was conducted during the year 2019-2020 in various apple orchards belonging to the southern region of the state of Jammu and Kashmir. A total of ten insect pests of apple with different orders were recorded i.e. Sanjose scale, Woolly apple aphid, Apple stem borer, green apple aphid, Apple blossom thrips, Gypsy moth, Bark beetle, Tent caterpillar, Codlingmoth, Apple root borer. Among these pests, Sanjose scale damages all parts of the plant like: leaves, flowers, stem, branches, roots, and fruits while Woolly apple aphid and Apple stem borer cause serious damage to the apple nurseries. Woolly apple aphid, Apple stem borer, Tent caterpillar, Codling moth are major pest of apple. Green apple aphid, Apple blossom thrips, Gypsy moth, Bark beetle, Apple root borer are minor pest of apple. Further investigations are needed in this regard so that apple growers and nursery growers would be able to produce a quality material to the market.

Keyword: Apple, Approaches, Insect Pest and Integration management

Effect of Nitrogen Sources and Row Spacing on Growth and Yield of Baby corn (Zea mays L.)

Prabhat Kumar Chaturvedi

Head, Department of Agronomy, National Post Graduate College, Barhalganj, Gorakhpur (U.P.) Indi

ABSTRACT

A field experiment was conducted at Crop Research Farm of National Post Graduate College, Barhalganj, Gorakhpur (U.P.) during the rabi season of 2020 - 21 to study the Effect of Nitrogen Sources and Row Spacing on Growth and Yield of Baby corn (Zea Mays L.) . The treatments comprised four nitrogen sources viz N1 (100% Nitrogen through Urea), N2 (75% Nitrogen through Urea ,+ 25% Nitrogen through FYM), N3 (50% Nitrogen through Urea + 50% Nitrogen through FYM) and N4 (25% Nitrogen through Urea ,+ 75% Nitrogen through FYM) and 2 row spacing viz S1 (40 Cm x 15 Cm) and S2 (30 Cm x 15 Cm). Significantly higher chlorophyll content in leaves, protein and carbohydrate in baby corn cobs were recorded in Nitrogen sources N2 (75% nitrogen through urea + 25% Nitrogen through FYM) followed by N1 (100% nitrogen through urea) and the minimum was with N4 (25% Nitrogen through urea + 75% nitrogen through FYM) accompanied with spacing of S1 (40 Cm x 15 Cm). However, results revealed that N2 (75% Nitrogen through urea + 25% Nitrogen through FYM) and spacing of S1 (40 Cm in x 15 Cm) were found to be best source of Nitrogen and spacing , respectively and their combination N2S1 (75% nitrogen through urea + 25% nitrogen through FYM + 40 Cm x 15 Cm spacing) emerged superior over all other treatments combination in relation to yield attributes and finally yield of Baby corn.

Keywords: Baby corn, FYM, Urea, Row spacing and Yield

Biodiversity of Predatory Coccinellid Beetles (Coccinellidae: Coleoptera) from agricultural ecosystem of Garhwal region of Uttarakhand, India

Pushpendra K. Sharma

Department of Zoology, D.A.V. (P.G.) College, Dehradun (U.K.), India

ABSTRACT

The insects of family Coccinellidae are commonly known variously as ladybirds (English English, Australian English, and South African English), ladybugs (North American English), lady beetles or coccinellid beetles (preferred by scientists). The family name comes from its type genus, Coccinella. The family Coccinellidae comprises 5,200 described species worldwide. Most of them are of bright shining colors with a pattern of spots or patches against a contrasting background. These beetles are of extremely diverse habits. The majority of beetles are useful because of their predaceous nature; but some are harmful, being polyphagous. The other coccinellids are predators of a variety of pests viz., aphids, leaf-hoppers, scale insects, mealybugs, mites and other softbodied insects. Some are specific in their food choice, while many are polyphagous.

3rd International Conference on “Global Initiative in Agricultural, Forestry and Applied Sciences for Food Security, Environmental Safety and Sustainable Development (GIAFAS-2021)”

An extensive survey of predatory Coccinellid beetles (Coleoptera: Coccinellidae) was conducted in the agricultural areas of Garhwal region of Uttarakhand, India, over a period of fifteen years (July 2005 to June 2020). A total of 32 species of Coccinellids were collected from different study sites representing agricultural ecosystems. Out of these 32 species, 28 species were identified as predatory coccinellids, while 04 species were identified as phytophagous. The dominant species are *Coccinella septempunctata* Linn., *Coccinella transversalis* (Fabricius), *Cheilomenes sexmaculata* (Fabricius), *Anegleis cardoni* (Weise), *Harmonia dimidiata* (Fabricius), *Hippodamia variegata* (Goeze), *Hippodamia* sp., *Illeis cincta* (Fabricius), *Megalocaria dilatata* (Fabricius), *Micraspis discolor* (Fabricius), *Micraspis vincta* (Fabricius), *Micraspis* sp., and *Psyllobora bisoctonata* (Mulsant). The presence of 32 species of coccinellid beetles in agricultural areas suggests that Garhwal region have diverse and rich fauna of coccinellid beetles. A clear gradation in the species composition of coccinellid beetles along the altitudes was quite evident.

Modern Concept of Zero Budget Natural Farming **Udai Singh Rawat, Moinuddin and Garima Kaushik Parashar**

School of Agricultural Sciences, Shri Guru Ram Rai University Dehradun, Uttarakhand, India

ABSTRACT

Zero budget natural farming believes in natural growing of the crops without the use of chemical fertilizers, pesticides, herbicides or any other harmful material to the crops. Production of crops is based on zero cost. Natural and organic inputs used in the form of cow dung, cow urine, neem leaves, pulse flour and jaggery etc. for different treatment of seed, soil and also for pest management practices. By using this practice farmer will raise their income and live a happy life. As we all know that, excess use of harmful chemicals affect our environment human health, soil health. Lots of diseases and disorders have been seen in men women and childrens in a very young age. This is all due to the use of harmful chemicals. In Karnataka zero budget natural farming was adopted as a movement by farmer's and government also organize many camps to educate farmers about zero budget natural farming. Four astra of zero budget natural farming viz. Beejamntra, Jeevamrita, Mulching and Wahapasa. These are four astra mainly use seed treatment, increase microbial activity, conserve water and wahapasa is the condition in which water and air molecules present in soil. The Major astra for pest management viz. Agniastra, Brahmastra and Neemastra. The three Astra for pest management is mainly for the management of harmful pests.

Keywords: Agniastra, Beejamrit, Brahmastra, Jeevamrit, Mulching, Neemastra, Wahapasa, Zero budget natural farming

An Eco-Friendly Textile Fiber from Lotus

Jyoti Roy, Moinuddin* and Ankit Semwal*

Department of Horticulture, University of Calcutta, Kolkata- 700019 (W.B.) India

Shri Guru Ram Rai University, Dehradun (U.K.) India

ABSTRACT

Lotus (*Nelumbo Nucifera* Gaertn) is the National Flower of India. It is a sacred flower and occupies a unique position in the art and mythology of ancient India and has been an auspicious symbol of Indian culture since time immemorial. Other than that, a fiber substance extracted from the stems of lotus plant (*Nelumbo nucifera*) is Lotus Fiber. It is eco-friendly textile fabric much superior compared to any other such as cotton, silk and wool. Lotus grows naturally on Burma Lake especially on Lake-Inle in Myanmar. Lotus (*Nelumbo nucifera*) is one of the most ancient aquatic perennial plants from the family Nelumbonaceae, native to Asia, America and later widely spread to temperate and sub-tropical zones such as India, China, Japan, Middle East etc. The fabric extraction originated firstly in Myanmar (Burma). In general, farmers already know the use of lotus plant, almost all parts of lotus plant are in use for edible and medicinal purposes, and other than that most valuable product is fiber from the stems which are used as a superior textile fabric. Lotus fiber has many superior properties which makes it different from other fabrics. It is super hydrophobic, antibacterial, self-cleaning, breathable, moisture absorbent, wrinkle free environment friendly fiber. Extraction of the fiber can be done by a slight cut around the stems by blade, after that the stems are pulled to break into parts and twist the parts to expose the fiber and slightly wind up on a roll in the form of yarn. The extraction process is not difficult if workers are properly trained. A well-trained spinner can produce up to 250 meters of thread a day. The material made by this fiber is light in weight and breathable. It can be dyed by both dyes (natural dyes and chemical dyes). The resulting fabric has the appearance of antique linen or raw silk, it is soft, exceptionally breathable and crease-resistant. Due to the hand holding process it is more expensive and has a huge market internationally. The production of this fiber will generate employment as it is more labour intensive and will give farmers the chance to contribute to environment friendly fiber production. After China and Japan, India is the largest producer of Lotus (*Nelumbo nucifera*), which indicates Lotus fiber production can double the income of the farmers.

Keywords: Antibacterial, eco-friendly, expensive, Lotus, Lotus fiber, textile fiber.

Life cycle, incidence and intensity of attack of cut and dry bamboo borer- *Chlorophorus annularis* Fab. (Coleoptera: Cerambycidae)

K.P. SINGH¹ and Mohammad Faisal²

Forest Entomology Discipline, Forest Research Institute, Dehradun(UK)

School of Agriculture, Forestry & Fisheries, Himgiri Zee university, Dehradun(UK)

ABSTRACT

Bamboos are woody grass belonging to family Poaceae and sub family Bambusoideae having 1250 species under 75 genera. Bamboo is distributed in tropical, subtropical and temperate zones and is known as “bamboo culture”, “green gold”, “poor man’s timber” and “the cradle to coffin timber”. Bamboo plays an important role in the forest economy and the cultural features of India. Bamboo has versatile uses for scaffoldings, food during famine and seasonal scarcity, agricultural implements, building material, fishing rods, weaving material, parquet manufacture and as water conduits. Bamboos are very susceptible to insect damage and are attacked by 212 insect species at various stages.

Chlorophorus annularis Fab. is a primary borer of cut and dry bamboo. Adult emerge in May-September mainly in June. Female of *C. annularis* laid eggs on cut bamboo during May-July. Freshly laid egg shape is elliptical, off-white in colour and later changed to yellowish white. Single female lays 21.6 ± 2.59 eggs. Incubation period is 12.9 ± 1.46 days. *C. annularis* larvae are milky white and on hatching, bore into the tissues of the walls of the bamboo. Colour of Pupa is off-white and later changes to yellowish white. Pupal period is about one month during March-April. Life cycle completed in one year. *C. annularis* was found damaging for the first time on 8 dry bamboo species viz. *Bambusa polymorpha*, *B. balcooa*, *B. giganteus*, *B. multiplex*, *B. tulda*, *B. vulgaris*, *B. spinosa*, and *Dendrocalamus strictus*. Three bamboo species viz. *polymorpha*, *B. balcooa* and *B. giganteus* were considered under high intensity of attack; whereas in *multiplex*, *B. tulda* and *strictus* the intensity of attack was considered under moderate category. *B. vulgaris* and *B. spinosa* were considered under low intensity of attack.

Keywords: Bamboo, borer, *Chlorophorus annularis*, infestation

Current Scenario of Precision Farming in India

Moinuddin, Nidhi Srivastava, Kumari Anjali, Vineeta Pandey and Satendra Tiwari

School of Agricultural Sciences, Shri Guru Ram Rai University- Dehradun, Uttarakhand, India

ABSTRACT

Precision farming (Precision Agriculture) is generally defined as information and technology based farm management system to identify, analyze and manage spatial and temporal variability within fields for optimum productivity and profitability, sustainability and protection of the land resource by minimizing the production cost. Increasing environmental consciousness of the general public is necessitating us to modify agricultural management practices for sustainable conservation of natural resources such as water, air and soil quality, while staying economically profitable, the use of input (That is chemical fertilizer & pesticides) based on the right quantity, at the right time and in the right place. This type of management is commonly known as “Site-specific management”. The productivity gain in global food supply have increasingly relied on expansion of irrigation scheme over recent detail, with more than a third of the world’s food now requiring irrigation for production. All together, market-based global competition in agriculture products is challenging economic viability of the traditional agriculture system and requires development of new and dynamic production system.

Keywords: Sustainability-Profitability, Site-specific management, Minimizing cost, Food supply.

Role of Genetics & Plant Breeding In Maintaining Positive Relationship Between Food Security, Environmental Safety & Sustainable Development.

NISHTHA^{*1}, SHANZA BAIG² & AKASH SHUKLA³.

¹Forest Genetics, Division of Genetics & Tree Improvement, ²Forest Botany Division, Forest Research Institute, Dehradun, U.K.

³Forest Management, Silviculture, Forest Management & Agroforestry Division, Jabalpur, M.P..

ABSTRACT

Food security is fundamental need for human existence. Food security is said when all the people at all times have physical, social, and economic access to sufficient safe and nutritious food that meets their food preferences and dietary needs for an active and healthy life. There are four pillars of food security which is availability, accessibility, utilization, stability. Food security and environment safety are the two complementing element for our sustainable development and future. We need novel solution for our future food security, environment safety and to maintain sustainability. Plant breeding and genetics has

3rd International Conference on “Global Initiative in Agricultural, Forestry and Applied Sciences for Food Security, Environmental Safety and Sustainable Development (GIAFAS-2021)”

considerably increased agricultural yields in recent decades and at the same time, intensification of farming has had negative environmental effects. The food security is under immense pressure of the increasing world population growth, increasing demand of food and the global food crisis began with the sudden increase in food price all over the world. There are various new plant breeding technologies which helps in maintaining food security, environment safety and sustainability. The Primary objective of plant breeding is to increase the crop yield and the secondary objective is quality improvement for high agricultural output to met the global food security and to maintain sustainable balance. Gene editing methods such as CRISPR/Cas system that was developed in 2012 is now widely used in food security by maintaining desirable plant trait and also maintains sustainability. MAS a widely used plant breeding technique manipulates the genomic regions that are involved in the desirable trait of interest through DNA markers and helps in maintaining food security. Food security can be maintained with the help of GMOs in which genes coding for desirable traits have been inserted through the process of genetic engineering. Nutritionally enhanced food crops with increased bioavailability are developed using modern biotechnological techniques, conventional plant breeding and agronomic practices refers to biological fortification or biofortification. Biofortification helps in fighting hidden hunger or micronutrient malnutrition and also helps in maintaining food security and sustainability. The use of new plant breeding techniques can help to increase crop diversity, raise yield potential, provides better resistance to pests and diseases, makes crop more resilient to environmental shocks and ofcourse new plant breeding techniques helps to maintain sustainable food production and nutritional security.

Keywords: MAS, Gene editing, CRISPR/Cas, Biofortification, hidden hunger.

Study of Diversity of Family Encyrtidae (Hymenoptera: Chalcidoidea) in Forest and Agricultural and horticulture Habitat of Doon Valley, Uttarakhand, India.

Rashmi Nautiyal and Sudhir Singh*

Harsh Vidiya Mandir (P.G) College, Raisi, Haridwar (Uttarakhand)

**Forest Entomology Division, Forest Research Institute, Dehradun (Uttarakhand)*

ABSTRACT

The present study is based on collection of Encyrtidae (Chalcidoidea: Hymenoptera) made during a survey in Doon Valley from 2008 to 2011 in all the five seasons (Spring, Summer cum Pre-monsoon, Monsoon, Post-monsoon, Winter) for each year. The collections were made from different localities of forest and agriculture and horticulture habitat of the Valley using sweep net method. In all the tree habitats a total of 1322 encyrtids were collected with sweep net. Out of which 745 were collected from forest, 276 from agriculture and 301 were collected from horticultural areas. In forest habitat out of 745 encyrtid specimens, the highest number of 269 specimens were collected during post monsoon, 150 during summer, 129 during monsoon, 110 during spring and lowest of 87 specimens were collected during winter. In agriculture habitat out of 276 specimens, the highest number of 116 was collected during post monsoon, 56 specimens during spring, 39 specimens during winter, 36 during summer and lowest number of 29 during monsoon. In horticulture habitat out of 301 specimens collected, the highest numbers of 158 encyrtid specimens were collected during spring, followed by 56 during summer, 36 during post monsoon, 30 during winter and lowest of 21 specimens during monsoon. During collection 117 species of Encyrtidae belonging to 43 genera under 2 subfamilies were recorded. The subfamily Encyrtinae was represented by 93 species under 34 genera followed by subfamily Tetracneminae with 24 species under 9 genera.

Keywords: Parasitic Hymenoptera, Encyrtidae, diversity, sweep net

Yield Gap Analysis Through Cluster Frontline Demonstrations in Groundnut in Nalgonda District, Telangana State

Shankar, M1*, M. A. Aariff Khan1, T. Bharat1, S. Pallavi1, M. Shankaraiah1 and K. Sumalini2

¹Krishi Vigyan Kendra, Kampasagar, PJTSAU, Nalgonda Telangana 508 207 India

²Agricultural Research Station, Kampasagar, PJTSAU, Nalgonda Telangana 508 207, India

ABSTRACT

The present study was carried out by Krishi Vigyan Kendra, Kampasagar, Nalgonda districted to assess and analyze the yield gap between improved package of practices under Cluster Frontline Demonstrations (CFLDs) and farmers practice during Rabi 2016-17 to 2020-21 in groundnut crop. The results revealed that, the highest average pod yield was recorded in CFLD (2341.6 kg/ha) with 27% higher over to farmers practice (1843.6 kg/ha). The average extension gap (EG), technology gap (TG) and technology index (TI) were 498.0 kg/ha, 658.4 kg/ha and 21.9%, respectively. The average Sustainability Yield Index (0.78) and Sustainability Value Index (0.84) were high in improved practices than farmers practice (0.76 and 0.75) respectively. Similarly, the average gross returns (Rs. 1,28,283.0/ha), net returns (Rs.71,934.0/ha) and Benefit Cost ratio (2.6:1) were higher in improved practice when compared to farmers practice. The mean of additional gross returns (Rs. 24,873.0/ha), cost of cultivation (Rs. 4,151.0/ha), net returns (Rs. 28,402.0/ha) with incremental BC ratio 6.0:1 was observed in improved practice. The average yield gap percentages within district and state averages were 64.2% and 45.6%,

3rd International Conference on “Global Initiative in Agricultural, Forestry and Applied Sciences for Food Security, Environmental Safety and Sustainable Development (GIAFAS-2021)”

respectively. The per cent increased horizontal spread of area under groundnut was 14.1%, 23.9% and 27.5% during 2017-18, 2019-20 and 2020-21, respectively, whereas in 2016-17 and 2018-19 per cent horizontal spread area decreased to -52.3% and -15.9% with cultivation of improved varieties i.e. K-9 and ICGV 3043 against old traditional varieties (K-6 and TAG 24).

Keywords: Groundnut, CFLD, Yield gap analysis, Sustainability yield index, Sustainability value index, Economics.

ROLE OF PLANT BREEDING TECHNOLOGIES AND STRATEGIES TO MAINTAIN THE POSITIVE RELATIONSHIP BETWEEN FOOD SECURITY, ENVIRONMENTAL SAFETY AND SUSTAINABLE DEVELOPMENT

Nishtha and Shanza Baig

Forest Botany Division , Forest Research Institute, Dehradun (UK) INDIA

ABSTRACT

Food security is fundamental need for human existence. Food security is said when all the people at all times have physical, social, and economic access to sufficient safe and nutritious food that meets their food preferences and dietary needs for an active and healthy life (UNDP). There are four pillars of food security which is availability, access, utilization, stability. Food security and environment safety are the two complementing element for our sustainable development and future but the use of high agrochemicals combined with unsustainable agronomic practices has led to several environment externalities. We need novel solution for our future food security, environment safety and to maintain sustainability. Plant breeding has considerably increased agricultural yields in recent decades and at the same time, intensification of farming has had negative environmental effects. The various new plant breeding technologies which helps to maintain food security, environment safety and sustainability. Gene editing is defined as the technique of insertion, modification, replacement or deletion of DNA in the genome of a living organism at a predetermined locations. The primary objective of plant breeding is to increase the crop yield and the secondary objective is quality improvement for high agricultural output to met the global food security and to maintain sustainable balance. MAS manipulates the genomic regions that are involved in the desirable trait of interest through DNA markers and helps in maintain Food security can be maintained with the help of GMOs in which genes coding for desirable traits have been inserted through the process of genetic engineering. Nutritionally enhanced food crops with increased bioavailability to the human population that are developed and grown using modern biotechnological techniques, conventional plant breeding and agronomic practices refers to biological fortification or biofortification. Biofortification will help in fighting hidden hunger or micronutrient malnutrition and also helps in maintaining food security and sustainability. The food security is under immense pressure of the increasing world population growth, increasing demand of food and the global food crisis began with the sudden increase in food price all over the world. Loss of biodiversity, urbanization, industrialization and deforestation are also contributing as a major threat to biodiversity.

Keywords: Plant breeding, Food Security, Environmental Safety

IMPORTANCE OF AQUAPONICS IN AGRICULTURAL TECHNOLOGY

Shivangi Pandey, Moinuddin, Suneeta Singh, Ankit Semwal and Shubanshu Karasi

School of Agricultural Sciences , Shri Guru Ram Rai University- Dehradun, Uttarakhand India

ABSTRACT

Aquaponics is the biointegrated method of corporation of water, fish and plants together in a closed system. The fishes supplement the plants by providing them proper nutrients that are being derived by the fishes. It consists of both aquaculture and hydroponics in a way that it helps in sustainable growth of plants. It is a soilless method of cultivating plants that are disease free, healthy and nutrient. The plants are grown only in water same as in hydroponics but the only difference is that in this system fish farming is also done at the same time. The fish water which is full of nutrients and supplement is used as growing medium for the active growth of plants with is fully organic. This system is costly but yet very effective for installing in areas where soil is less or infertile in nature with high yield profit. Disease resistance risk is very low and specifically risk of soil born diseases is very minor. It gives higher level of bio security and allows a higher control on production leading to lower losses. Proper parameters should be followed in aquaponics such as proper O₂ rate should be maintained in water for fishes as well as for plants, healthy supplements for fishes, appropriate water rate, water temperature and all. It gives new employment opportunities and knowledge to the new farmers in natural and organic way. Aquaponics only need 1/10th of the water to grow 8 times more food/acre compared to the traditional agriculture. It mimics nature as the plant kingdom reuses the leftover from the animal kingdom fish to close a circular loop.

Keywords: Animal Kingdom, Aquaponics, Nutrients, Organic, Supplements

Root-knot Nematode, *Meloidogyne incognita* Pest of Vegetables and its Eco-friendly Management
Amir Khan^{*1}, Mohammad Haris², Gufran Ahmad², Adnan Shakeel² and Abrar A. Khan¹

¹Plant Pathology and Nematology Section, Department of Botany, Aligarh Muslim University, Aligarh, 202002, India

²Section of Environmental Botany, Department of Botany, Aligarh Muslim University, Aligarh, 202002, India,

ABSTRACT

Root-knot nematodes (Genus; *Meloidogyne* spp.) are sedentary endoparasitic and soil-borne pathogens around the world. *Meloidogyne incognita* is one of the most devastating and dominant species of this genus damaging a variety of vegetables and other crops. Among the vegetables, eggplant, tomato, okra, chilli, carrot and beetroot are severely infected by this pest. Root galls are the most prominent and primary infection of this nematode due to which the transportation of nutrients and water to the shoots and leaves of the plants is severely affected. Due to the increasing destruction and losses by these nematodes the management of this nematode is very necessary. From researchers to growers each one's keen interest is the strategies and further plans to control the nematode infestation. Now a day's environmental pollution is the major problem in the world. Among the major causes of environmental pollution, the long term utilization of pesticides is one of the most important causes that affect soil fertility and has a negative impact on both human health and the environment. So, keeping this view in mind, researchers all over the world are engaged in eco-friendly and non-chemical approaches such as biological, cultural and physical that keep the nematodes below the threshold level as well as beneficial for the environment, human health and stabilize the vegetables production.

Key words: Root-knot Nematode, *Meloidogyne incognita*, Vegetables, Organics and Biological management

Applications of Eco-Friendly Natural Dye on Wool Fibers Using Combination of Natural and Chemical Mordants

Shyam Vir Singh

Department of Chemistry, SGRR (PG) College, Pathribagh, Dehradun, Uttarakhand, India- 248001

ABSTRACT

The colour fastness properties of the flowers of *Erythrina suberosa* dyed on wool were studied using combination of mordants such as lemon juice: copper sulphate, lemon juice: potassium dichromate, lemon juice: ferrous sulphate and lemon juice: stannous chloride in the ratio of 1:3, 1:2 and 3:1. Dyeing along with mordanting techniques which included pre-mordanting, simultaneous mordanting and post mordanting was carried out. Study about fastness tests of dyed clothes was undertaken. Large range of shades was obtained because of varying mordant ratios and combinations. The washing, rubbing, light and perspiration fastness of the dyed samples was also evaluated, giving fair to excellent fastness grades and this evaluation also useful for textile industries.

Keywords: Natural dye, *Erythrina suberosa*, Mordants, colour fastness properties

Biomass and productivity of Khejri (*Prosopis cineraria*) based agroforestry systems in arid part of India.

SANDEEP ARYA*, AND O. P. TOKY

CCS Haryana Agricultural University, Hisar, Haryana

ABSTRACT

Khejri (*Prosopis cineraria*) is of great importance to communities of dry areas providing fuel, fodder, food, small timber and medicines. The Khejri also improves soil fertility and helps in sand dune stabilization. We identified fields of agroforestry systems in Haryana and Rajasthan and carried out research work on phytosociology and biomass production. Extensive survey of 'Khejri' based agroforestry systems was carried out in the western parts of Haryana and Sikar and Churu districts of Rajasthan in total 6 agroforestry fields were selected. The mean of importance value index (IVI) of this species was very high (200%) which showed its strength in the ecosystem and that reflects its role in the resilience. Biomass of bole, branches

3rd International Conference on “Global Initiative in Agricultural, Forestry and Applied Sciences for Food Security, Environmental Safety and Sustainable Development (GIAFAS-2021)”

and leaves varied enormously from 199 kg/tree in 20 to 25 cm diameter class to 318 kg/tree in 40-45 diameter class, and leaves constituted 30 per cent of the total biomass. The biomass of wheat, mustard and Black gram was observed under Khejri.

Key words: Agroforestry, Khejri (*Prosopis cineraria*), Biomass, productivity.

Verification of Fertilizer Prescription for Targeted Yield of Soybean [*Glycine max* (L.) Merrill] in Vertisol

S.S. Baghel, Pradip Dey and R.K. Sahu

Department of Soil Science Jawaharlal Nehru Krishi Vishwa Vidyalaya, Jabalpur - 482 004. M.P. INDIA

ABSTRACT

Consecutive for three years (2014 -17), field trials were conducted to verify the fertilizer were conducted Adjustment equation developed for targeted yield of soybean on medium black soil at research farm, Jawaharlal Nehru Krishi Vishwa Vidyalaya, Jabalpur five treatments were framed to evaluate and verify the fertilizer adjustment equation. The treatments were: farmers practice (control), general recommended dose and other three targeted yield levels (2500, 3000 and 3500 kg ha⁻¹). The soil was normal in pH, EC and low OC. while it was recorded low in available nitrogen and medium in available phosphorus and potassium. The fertilizers application was done using the developed fertilizer adjustment equation as 5.19 TY- 0.48 SN, 5.20 TY - 4.10 SP and 3.90 TY - 0.22 SK for fertilizer requirement for the nitrogen, phosphorus and potassium and by substituting the soil test value for SN, SP and SK respectively. The results revealed that there was consistent yield recorded in all the three-years of experimentation signifying the effect of treatment. The increase in yield due to general recommended dose and fixed target were significant over control achieving the lower target fixed for 2500 kg ha⁻¹, deviating by 2 to 11 per cent. While the target fixed for 3500 kg ha⁻¹, deviated negatively from 8-10 per cent. However, the yield in all the three years increased over control and general recommended dose due to higher dose of fertilizer application, having maximum yield of 3024, 3135 and 3210 kg ha⁻¹, which increased by 45.5, 47.5 and 103 per cent over control and 18.1, 18.75 and 65.4 per cent over general recommended dose. This Increase in yield was constant in the first and second year but in third year there was increase in yield over control. This indicated that the fixed targeted yield can be achieved by applying the fertilizer based on fertilizer adjustment equation successfully for sustainable production and maintaining soil health.

Keywords: Fertilizer adjustment equations, targeted yield, B:C ratio

Evaluation of the Influence of Certain Types and Doses of Organic Manures on Seed Germination and Seedling Growth of Foxglove (*Digitalis purpurea* L.) at Temperate Hill Ranges of Bharsar, Uttarakhand

Bhatt, N.¹, Singh, K.C. *¹, Goswami, G.¹, Haobijam, J.W².

¹College of Horticulture, VCSG Uttarakhand University of Horticulture & Forestry, Uttarakhand – 246123, India

²School of Agriculture, Lovely Professional University, Jalandhar – 144411, India

ABSTRACT

In a study of response of foxglove (*Digitalis purpurea* L.) to different types and doses of organic manures namely, FYM, compost and vermicompost, it was seen that vermicompost @ 15 t/ha consistently witnessed providing superior performances in all the traits under study like quickest germination (4 days), highest germination per cent (77.33 %). Also,

3rd International Conference on “Global Initiative in Agricultural, Forestry and Applied Sciences for Food Security, Environmental Safety and Sustainable Development (GIAFAS-2021)”

tallest plant height (8.63 cm), longest leaf length (6.64 cm), maximum leaf count per plant (9.26), widest plant spread (11.22 cm), total fresh and dry biomass (2.73 g/plant and 0.71 g/plant, respectively), widest leaf area (15.36 cm²), longest root length (10.80 cm) and highest root diameter (1.67 mm) were being recorded in vermicompost @ 15 t/ha at 90 DAS and were found statistically significant.

Keywords: Foxglove, germination, seedling-growth, FYM, compost, vermicompost

***IN VITRO* REGENERATION ABILITY OF TUBEROSE (*Polianthes tuberosa* L.).**

¹ABHINASH MOIRANGTHEM, ²SOU MEN MAITRA, ³PUNABATI HEISNAM AND ³M BISWAPATI DEVI

Central Agricultural University, College of Agriculture, Imphal

²Uttar Banga Krishi Viswavidyalaya, Pundibari, Cooch Behar

³Central Agricultural University, College of Horticulture and Forestry, Pasighat

ABSTRACT

An experiment was conducted at the tissue culture lab of Uttar Banga Krishi Viswavidyalaya, Pundibari, Cooch Behar, West Bengal at the Department of Floriculture, Medicinal and Aromatic Plants, in 2014-2015 and 2015-2016 to study the regeneration ability of different Tuberose cultivars *in-vitro*. Four different tuberose cultivars namely Calcutta Single, Calcutta Double, Vaibhav and Suvasini were tried in 16 different culture media. Results revealed that the cultivar Calcutta Double when cultured in MS medium supplemented with kinetin (1 mg/ l) showed higher regeneration [68.89 (56.12) %], when grown in MS medium supplemented with BAP (2 mg/ l) showed earlier regeneration (18.06 days) and produced higher number of microshoots (3.67) per culture, but culture in MS medium supplemented with GA₃ (2 mg/ l) and BAP (1mg/ l) resulted earlier (28.53 days) rooting. The *in-vitro* regeneration ability of the same cultivar was found higher as compared to other cultivars and culture medium containing MS + BAP (2 mg/ l) recorded earlier regeneration and higher microshoot development and hence can be utilized for *in-vitro* propagation of Tuberose.

Keywords: Tuberose, tissue culture, regeneration, BAP, GA₃, kinetin

Studies on Honeybee, *Aphis mellifera* L. and plant biodiversity including Agroforestry in semi arid region of Rajasthan

SK KHINCHI, SL SHARMA, SP SINGH

Department of Entomology, Sri Karan Narendra College of Agriculture, (SKNAU), Jobner-303329, Rajasthan, India

ABSTARCT

Honeybee, *Aphis mellifera* L. was introduced at plant biodiversity park, Sri Karan Narendra Agriculture University, Jobner, Rajasthan in October, 2020. Plant biodiversity park maintained and pollen provided throughout the year. A flora calendar for the semi arid region of Rajasthan has also been prepared. Agroforestry was available near apiary. A period of August to March was suitable for honeybee, *A. mellifera*. During rainy, low and high temperature days a partial nector dearth was recorded which could overcome by providing sugar solution feeding. Honey cells fully or partially closed in each frame. Honey was not extracted except one frame due to survival of honeybee, *A. mellifera*. In single frame 2.0 kg honey was extracted in June month. It forms the first report of successful introduction of honeybee, *A. mellifera* in semi arid region of Rajasthan.

Key words: Honeybee, *Aphis mellifera* L., introduction, plant biodiversity, semi-arid, honey

FLORISTIC DIVERSITY, ABOVEGROUND BIOMASS AND CARBON STOCK IN COFFEE-BASED AGROFORESTRY SYSTEM AND ADJOINING NATURAL FORESTS OF CENTRAL WESTERN GHATS, INDIA

B. G. Nayak¹, Raju Chavan², Devagiri, G. M.³, Hareesh, T. S.⁴ and Sathish, B. N⁴

1. Department of NRM, College of Forestry, Ponnampet, 571 216, KSNUAHS Shivamogga, Karnataka, India
2. University of Agricultural Sciences, Dharwad 580 005, Karnataka, India
3. Department of NRM, College of Forestry, Ponnampet, 571 216, KSNUAHS Shivamogga, Karnataka, India
4. Department of FPU, College of Forestry, Ponnampet, 571 216, KSNUAHS Shivamogga, Karnataka, India.

ABSTRACT

Kodagu is one of the greenest landscapes in India with 81% of the geographical area under tree cover contributing to the rich biodiversity representing about 8% of India's plant wealth. The study was aimed to assess and compare the floristic diversity, biomass and carbon between coffee-based agroforestry system and adjoining natural forests. We used random sampling technique for field data collection and 50 sample plots of 40 m x 40 m (0.16 ha.) were laid, of which five in adjoining evergreen forests and 45 in coffee-based agroforestry system, during the year 2018-19. Total of 102 tree species in coffee agroforests and 50 tree species in adjoining forests were recorded. Shannon's diversity was highest in coffee agroforests (3.60) compared to the natural forest (3.32). Higher tree density (351 ± 19.35 stems ha⁻¹) was recorded in coffee agroforests compared to natural forests (287 ± 13.53 stems ha⁻¹). Conversely, basal area was found to be higher in natural forests (39.53 ± 0.38 m² ha⁻¹) compared to coffee agroforests (29.54 ± 1.34 m² ha⁻¹). Amount of carbon stored in adjoining natural forests was to the tune of 88.84 ± 2.90 Mg ha⁻¹ while in coffee-based agroforestry system it was found to be 77.39 ± 3.30 Mg ha⁻¹. Management of coffee agroforests, particularly shade tree management, plays an important role in carbon storage and dynamics. *Artocarpus integrifolia* (23.11%) was the dominant tree species in coffee agroforests whereas, *Elaeocarpus tuberculatus* (28.25%) was dominant in natural forests. Girth class distribution showed the pattern of inverted J shape curve, while in agroforests it was positively skewed. Based on the results of this study, we conclude that traditional coffee-based agroforests are floristically richer than adjoining natural forests and these land-use systems offer greater opportunities for biodiversity conservation as well for higher carbon storage in this region.

Key words: Western Ghats, Coffee based agroforestry system, Floristic diversity, Above-ground biomass, Carbon stock.

Agricultural waste biomass utilization for energy production through gasification

Sunil L Narnaware and N L Panwar

Department of Renewable Energy Engineering, College of Technology and Engineering Maharana Pratap University of Agriculture and Technology, Udaipur- 313 001

ABSTRACT

Waste residues produced from agricultural activities have huge potential for renewable energy production by adapting appropriate technology which can provide a solution to issues like on-field decomposition, or burning creating environmental pollution. Biomass gasification is the thermochemical conversion technology that converts biomass into a gaseous product and is considered a mature technology. The gasification process takes place at an elevated temperature (900-1200 °C) and in a sub-stoichiometric environment (ER=0.25-0.40) to produce combustible gases called producer gas which has a low heating value between 1000-1200 kcal/Nm³. Producer gas can be used in conventional energy conversion devices like gas engines, turbines or more sophisticated equipment such as fuel cells for power generation whereas for thermal application furnaces and boilers can be used. Biomass gasification is regarded as renewable technology, provides flexibility for use of different

3rd International Conference on “Global Initiative in Agricultural, Forestry and Applied Sciences for Food Security, Environmental Safety and Sustainable Development (GIAFAS-2021)”

biomass, can produce energy on a smaller to a larger scale, and has immense potential for employment in rural areas. The surplus agricultural waste biomass can be utilized for waste-to-energy to substitute and conserve fossil fuels through gasification. The present paper provides an overview of the gasification technology for the utilization of agricultural waste biomass for heat and power generation.

Pusa concentric storage structure in District Kanpur Nagar (U.P.)

Nimisha Awasthi, Anjali Sahu*, and Arun Kumar Singh

KVK Kanpur Dehat, and KVK Kushi Nagar C.S.A. University of Agriculture and Technology, Kanpur, IIVR Varanasi**

ABSTRACT

Onions are an important vegetable world-wide, ranking second among all vegetables in economic importance with an estimated value of \$6 billion dollars annually. While onions contribute significant nutritional value to the human diet and have medicinal properties. Onion besides being a highly remunerative crop, farmers usually sell all the produce except leaving some portion for household use because of its perishability, they cannot wait for getting good price, therefore to address the issue Pusa concentric onion storage structure were introduced and tested for its efficiency in Kanpur Nagar. Study is result of one of On Farm Trial conducted in Basen and Kurmikhhera village of Chaubeypur and Shivrajpur village of district Kanpur Nagar of Krishi Vigyan Kendra, Kanpur Dehat. Both of the villages were selected purposively as both villages are known for their maximum onion area. Ten small farmers producing onion were selected and 2 Pusa Concentric Storage structure (with some moderations) of 4.5 quintal capacity were provided to each selected farmers. Structure was provided in the year 2018 and Data were taken in three consecutive years i.e. during 2018 and 2020. Onion Storage structure were fabricated by local artisan on order basis so cost of structure gone quite high as up to 1200 per structure. The technology has proven highly efficient as weight loss under PUSA concentric structure was 9.00 per cent with comparison to farmers practice of spreading on floor/ or keeping on bamboo basket was calculated more than sixteen percent in the month of May 2018. Weight loss was 10.1 in May, 2019 and 9.2 percent in 2020. Average rotting occurred in 11.20 percent onion kept in structure while it was 23 percent in farmers practice. But availability/ fabrication was a big challenge in popularization of technology. It is recommended to train local artisans so that structure can be fabricated at local level. As far as acceptability is concerned 45.83 per cent farmers opines it was good whereas, 78.33 per cent farmers were in view that Quality of produce kept in structure was good in comparison with farmers practice.

Keywords: Storage Onion, Rotting, Structure, Perishable, Flavour, Concentric

Effect of direction of sowing on growth and yield of Wheat (*Triticum aestivum* L.) Cultivars

Ravikesh Kumar Pal^{1*}, A. K. Singh², Pramod kumar³, Prithvi raj¹ and Shashank Tayagi⁴

^{1*} Department of Agronomy, Bihar Agricultural University Sabour Bhagalpur Bihar -813210.

² Department of Agronomy, A.N.D.U.A. & Tech. Ayodhya UP.-224229

³ Department of Agronomy, C.S.A.U. Of Agriculture & Tech. Kanpur UP -208002.

⁴ Department of Agronomy, Bihar Agricultural University Sabour Bhagalpur Bihar -813210..

ABSTRACT

Wheat (*Triticum aestivum* L.) belongs to the family Gramineae (Poaceae). It has been described as the ‘King of cereals’ because of the acreage and high productivity. Globally, wheat is being grown in 122 countries, Wheat ranks first in the world among the cereals both in respect of area and production. Sunlight is a major source of photosynthesis in plant because it’s provided energy to conversion of assimilates from inorganic to organic world so sowing of wheat crop in better direction is

3rd International Conference on “Global Initiative in Agricultural, Forestry and Applied Sciences for Food Security, Environmental Safety and Sustainable Development (GIAFAS-2021)”

very important for maximum utilization of solar light. Adoption of suitable cultivar is also most important for getting better production and productivity.

A field experiment was carried out at Agromet. Research Farm of Narendra Deva University of Agriculture & Technology, Narendra Nagar (Kumarganj), Faizabad (U.P.) during *Rabi* season of 2016-17 to study the effect of direction of sowing on growth and yield of wheat cultivars. Six treatments consisted of three cultivar of wheat and two direction of sowing. The experiment was conducted in Randomized Block Design with four replications. All the growth characters like plant height, dry matter accumulation, number of tillers, leaf area index were significantly higher under East-West direction of sowing over North-South direction of sowing. Among the cultivars PBW-343 was found significantly superior over NW-1012 (except plant height maximum at NW-1012 at par with PBW-343 and significantly superior over HUW-234) and HUW-234. The yield attributes like number of effective tillers, spike length, number of grains spike⁻¹, grain weight spike⁻¹, grain yield, straw yield and light interception were increased significantly under East-West direction of sowing and among the cultivar PBW-343 recorded significantly higher value of above characters over NW-1012 and HUW-234. Maximum heat unit requirement and days taken to 50% ear emergence and maturity was recorded under North- South direction of sowing and among the cultivar PBW-343. The maximum net return (Rs. 64058 ha⁻¹) and B:C ratio 1.53 were obtained at E-W direction of sowing along with cultivar PBW-343. Thus it may be concluded that sowing in East-West direction with cultivar PBW-343 was found most suitable for cultivation under Eastern UP.

Keyword: Direction of sowing, cultivar, Heat unit requirement.

Protective effects of Zinc with dietary nutrients on biochemical and hematological parameters of albino rats intoxicated with Cadmium chloride

Shivani yadav*^a, Ruhi Tomar^b, D.K Chauhan^c, Kavita Verma^d, Divya Singh^e

^{a,b,c}Department of Zoology, Chaudhary Charan Singh University, Meerut, Uttar Pradesh (250004)

^{d,e}Department of Zoology, Meerut College, Meerut, Uttar Pradesh (250004)

ABSTRACT

The study highlights the protective effects of zinc (essential metal), vitamin B₁ (vitamin), Methionine (amino acid) and NAC, N-acetyl cysteine (antioxidant) on cadmium induced oxidative stress in Wistar rats. Animals were divided into the four groups. First group having Negative Control animals were given normal saline water for thirty days, while the second group having positive control animals were treated with cadmium chloride (2mg/kg) subcutaneously, third group were administered with cadmium chloride and zinc (CdCl₂+Zn), fourth group of animals were given cadmium chloride along with dietary nutrients that is zinc, vitamin B and NAC in combination (CdCl₂+Combination (Methionine+Zn+Vit B₁+NAC). The physiological response of Cd intoxication on the albino rats was evaluated towards haematotoxicity and hepatotoxicity based on various biochemical and histopathological variables. The protective effects of dietary nutrients were analyzed separately as acute and sub chronic studies for five and twenty days respectively. The overall toxic effects of continuous exposure to cadmium were assessed by monitoring body weight and organ-body weight ratio in rats. A significant decrease was observed in body weight, while significant increase in organ-body weight was observed after the Cd exposure as compare to control rats. It was evident from the data that accumulation of Cd was found maximum in kidney as compared to liver. The liver of treated rats exhibited marked pathological lesions such as cytoplasmic vacuolization, karyolysis, pycnosis, in hepatocytes and centrilobular necrosis. The kidney of control rats showed normal glomeruli and renal tubules, whereas Cd intoxicated evinced cellular glomeruli congestion. The results evinced that combined treatment of zinc (essential metal), methionine (amino acid), Vit-B₁ (vitamin) and NAC (antioxidant) was most effective than either of them alone in reversing Cd induced changes in the selected vital organs of albino rats.

Key words: Cadmium, Essential metal, Antioxidant, Methionine, Histology, Necrosis

Suitability of turmeric varieties against fungal diseases in Cuddalore district, Tamil Nadu

P.T. Sharavanan

Dept of Plant Protection Anbil Dharmalingam Agricultural College and Research Institute Tamil Nadu Agricultural University

ABSTRACT

The turmeric crop is affected by three major fungal diseases and the yield of rhizome varied due to the incidences of disease and variety performance. A study was conducted to assess the suitability of varieties against fungal diseases in Cuddalore district of Tamil Nadu. Three varieties viz., Co 2, IISR pragathi and attur ruling variety were used to assess the performance against the fungal diseases under field condition. The growth parameters and incidence of rhizome rot in turmeric was recorded from the on farm trial and the results indicated that rhizome rot incidence was low in Co 2 variety (2.12 %) and which was followed by IISR pragati (4.51%). The highest yield of rhizome was recorded by Co2 variety and which was followed by attur local variety. In the experiments, IISR pragati matured very earlier than other variety used in the study. The Co2 variety given higher net profit and B: C ratio in the study. The disease incidence viz., rhizome rot, leaf blotch and leaf spot were noticed in all the three varieties; however, rhizome rot incidence was very low in Co2 variety and followed by IISR pragati. The incidence of leaf blotch and leaf spot were comparatively less in IISR pragati when compared to Co2 variety.

Enhancement of knowledge level of paddy growers on ecofriendly cultivation practices by farmer’s field school approach

P.T. Sharavanan*

Department of Plant Protection, Anbil Dharmalingam Agricultural College and Research Institute , Tamil Nadu Agricultural University, Tiruchirapalli- 620 027

ABSTRACT

Farmer Field School (FFS) is a group-based learning method in which participants obtain knowledge that allows them to make their own locally specific crop management decisions through experiential learning activities. As a result, a farmer's field school on ecofriendly paddy cultivation was conducted in Sathukudal village, Vrindhachalam block, Cuddalore district. Twenty-five paddy farmers were chosen to attend the school. The knowledge level on ecofriendly cultivation practices was assessed by questionnaire method. 62.5 per cent of farmers were known about the ecofriendly cultivation practices and 6.25 per cent of farmers only followed the practices in their crop cultivation. The reasons viz., unavailability of input material and unknowing of methodology of preparation of products was identified for not following ecofriendly cultivation practices. The school consists of 14 classes on ecofriendly crop management practices at weekly interval and demonstrations on seed treatment with biofertilizers and bio control agents, use of green manure and green leaf manure, use of vermicompost, demonstration of soil sampling, need of soil nutrient management and nitrogen application based on leaf colour chart, foliar spray of *Pseudomonas fluorescens* @ 0.2% at 20 and 40 DAP, preparation of panchagavya and spray, spray of neem oil and neem seed kernal extract, setting of yellow sticky trap and pheromone trap, use of egg parasites *Trichogramma chilonis* were carried out. The school was conducted throughout the crop growth period. A demonstration plot for FFS and non FFS were also maintained simultaneously during the period of the FFS. The yield of FFS demonstrated plot recorded 5.88 t/ha as against non FFS plot recorded only 5.42 t/ha. The benefit cost ratio of the FFS plot increased to 2.14 from 2.05 in non FFS plot. The farmers realized the impact of ecofriendly practices on yield by observing increase of B: C ratio. The pest and disease incidence were also recorded in the FFS plot and compared with non FFS plot. The leaf folder, stem borer and blast

3rd International Conference on “Global Initiative in Agricultural, Forestry and Applied Sciences for Food Security, Environmental Safety and Sustainable Development (GIAFAS-2021)”

disease incidence were less when compared with non FFS plot. Finally, the knowledge of the farmers were tested and noted that knowledge level of the farmers were improved from 62.5 per cent to 93.75 per cent on ecofriendly cultivation practices.

Assessment of Academic stress on mental health of college students **Sangya Singh**

Department of Family Resource Management, College of Community Science, G.B.Pant University of Agriculture & Technology

ABSTRACT

The stress-reduction approach based on mindfulness practices has recently enjoyed an explosion of interest from a variety of healthcare and epidemiological researchers. Disrupted homeostasis elicits the so-called “stress response”, meaning the activation of central and peripheral neuroendocrine mechanisms responsible for various adaptive responses and behaviors. The purpose of this study was to measure the level of academic stress among the students of Post Graduation. The study used a convenience sample of female and male college students. A scale for measuring the perceived stress level was adopted. PSS assesses the perception of stressful experiences by asking the respondent to rate the frequency of his/her feelings and thoughts related to events and situations that occurred over the previous month to collect data from the respondents. The majority of the respondents agreed that they often perceived stress because of something that happened unexpectedly in the last month, they were unable to control the important things in their life, they were not confident enough to handle their problems or being unable to control irritations, etc. Students often perceived stress when things were out of their control or they found it difficult to pile the things up because of uncontrollable situations.

Keywords: Perceived stress, Disrupted, Homeostasis, Neuroendocrine

The effect of soaking and germination treatments on nutritive, antioxidant activity, and bioactive composition of quinoa (*Chenopodium quinoa* Willd.)

Priyanka Thakur*, Krishan Kumar, Divya Chauhan, Qurat Ul Eain Hyder Rizvi, Sumaira Jan, Naseer Ahmed, and Tajendra Pal Singh

Department of Food Technology, Dr. Khem Singh Gill Akal College of Agriculture, Eternal University, Baru Sahib, Sirmour, HP- 173101

ABSTRACT

Quinoa (*Chenopodium quinoa* Willd.) is an ancestral species from the Andean region, which is considered as a staple food for its population. Quinoa has evolved as a healthy substitute to gluten-rich grains for the preparation of gluten-free food products. Besides being gluten-free, they are also a rich source of protein, fiber, vitamins, and minerals. It is known to reduce bad cholesterol in body and raise good cholesterol due to its omega-3 and 6 content. It is a rich source of vitamins, minerals and also found to contain compounds like polyphenols, phytosterols, phytoestrogens and flavonoids. Soaking and germination are treated as simplest, cost-effective and the most commonly used techniques to improve the nutritional quality of food grains. Prior to germination treatment, seeds were soaked for 16 hours and then germinated for 24, 48, and 72 hours. The soaked and sprouted grain was dried at 40°C in a hot air oven. The prolonged soaking and germination time resulted in increasing the contents of crude protein, crude fiber, total phenolics content, and antioxidant activity significantly ($p \leq 0.05$) by 12.07, 34.59, 24.98, and 25.86% respectively. There was also significant ($p \leq 0.05$) decrease in crude fat, tannin content, and phytic content by 35.05, 27.08, and 14.58% during soaking and germination treatment respectively. Therefore, it can be concluded that soaking and germination treatments proved highly effective for improving the nutritional, anti-oxidant activity, bioactive components and decreased the anti-nutritional components of quinoa.

Keywords: Quinoa, Soaking, Germination, Nutritional, Antioxidant Activity, Phenolic and Anti-nutritional components.

Security and Nutritional Safety: A Challenge Ahead

Jasveer Singh¹ and Rohtash Kumar²

¹ *Sam Higginbottom University of Agriculture, Technology and Sciences, Prayagraj*

² *Agriculture Extension Choudhary Charan Singh Haryana Agricultural University, Hisar*

ABSTRACT

Today humanity is facing a daunting challenge. The natural resources, both on land and water, are increasingly in demand to cater to the human needs and expectations. In order to feed the burgeoning population of India and to attain food security, the

3rd International Conference on “Global Initiative in Agricultural, Forestry and Applied Sciences for Food Security, Environmental Safety and Sustainable Development (GIAFAS-2021)”

mission oriented efforts for increasing food productivity and its sustainability through advanced agro and biotechnological means are to be ventured. However, problems of climate change, biodiversity, desertification, water depletion, pollutants and toxicants, *etc* are being manifested, which in turn are becoming unfriendly to plant, animal and human health. There is an urgent need for developing methods to alleviate the environmental disorders in order to boost crop productivity. Soil health is defined as the continued capacity of soil to function as a vital living system, by recognising that it contains biological elements that are key to the ecosystem function within land use boundaries. Food security is defined as the state when people have physical and economic access to sufficient, safe and nutritious food to meet their dietary needs and food preferences for an active and healthy life. Future global environment change such as increased climate variability, land degradation and loss of biodiversity, in the context of social, political and economic changes, may bring unprecedented stress on the food production system and food security. Soil health management, however, can play a significant role in climate change mitigation and adaptation to reduce the vulnerability of Indian agriculture. Although worldwide there are clearly enormous number of people to feed, the high yields associated with mono cropping are not worth the long-term environmental and health costs of using fossil fuels and degradation of soil with chemical inputs. Integrated nutrient management, organic farming, biofertilisers, bioremediation, biocontrol and plant growth promoting rhizobacteria are important means for optimising crop production on both short term and long term basis to achieve sustainable production without deterioration of the environment and at the same time maintain the soil fertility.

Keywords: Dasagavya, Food security, Homofarming, India, Nutritional security, Panchagavya, Soil fertility

Integrated based nitrogen on the growth, yield, quality and economics of aromatic rice and their residual result on succeeding lentil under rice-lentil crop sequence

¹Punabati Heisnam, ²Abhinash Moirangthem, ¹Priyanka Irungbam, ¹Ph. Arunkumar Singh, ¹Bapsila Loitongbam and ³Asish Singha Roy

¹College of Horticulture and Forestry, Central Agricultural University, Pasighat, Arunchal Pradesh-791102

²College of Agriculture, Central Agricultural University, Iroisemba, Manipur-795001

³Uttar Banga Krishi Vishwavidyalaya, Pundibari, Coochbehar, West Bengal-736165

ABSTRACT

To study the direct and residual effect of integrated sources of nitrogen on the growth productivity and economics of rice (aromatic)-lentil cropping system investigation was conducted at the instructional farm of Uttar Banga Krishi Viswavidyalaya located at Pundibari, Cooch Behar, West Bengal during 2016-17 and 2017-18. The experiment was laid out in split plot design with 2 aromatic rice varieties (‘Gobindabhog’ and ‘Kalonunia’) in major plots and 12 treatments of nitrogen management in sub-plot. The results of the experiment showed that the variety ‘Gobindabhog’ (main plot) recorded higher growth, yield attribute, yield and quality (Carbohydrate, protein content, aroma, hulling percentage, milling percentage and Head rice recovery) as compared to Kalonunia. For the sub-plot, the treatment 50% RDN through fertilizer + 50% RDN through VC recorded to give maximum growth, yield attribute, yield and protein content. Application of 50% RDN through VC + 50% RDN through FYM took about positive response on the hulling (%), milling (%) and head rice recovery (%) and aroma. The highest rice carbohydrate content was found with 50% RDN through fertilizer + 25% RDN through VC + 25% N through FYM treatment. The maximum grain yield of residual effect of succeeding lentil crop was observed in plots of Gobindobog and 50% RDN through fertilizer + 50% RDN through FYM treated plots. The highest gross and net returns were obtained with the application of 75% RDN through fertilizer + 25% RDN through VC in the plots, where the crop was ‘Gobindabhog’ rice and the benefit: cost ratio was also higher in the same set of treatment.

Keywords: INM, Aromatic rice, Nitrogen, FYM, Vermicompost, Lentil, Gobindobhog, Kalonunia

Performance of medicinal and aromatic plants as intercrops in Kinnow orchard

***Manpreet Singh¹ and Dr. Kanwaljit Singh**

ABSTRACT

The field experiments were conducted to find out the growth of herbal medicinal crops under citrus based Agroforestry system at the Horticultural Farm, Khalsa College, Amritsar during 2019-20 and 2020-21. The experiments were laid out in randomized block design with seven treatments and three replications. The growth attributes *viz.*, plant height, number of leaves and leaf area index of medicinal plants except turmeric, reduced significantly while growing in the Kinnow orchard as compared to the sole medicinal crops. Moreover, growth of turmeric was the highest as an intercrop.

Key Words: medicinal and aromatic plants, intercrops, growth attributes, Kinnow orchard

Geospatial modelling of changes in land use/land cover dynamics in Part of Majhagawan Block using geo-informatics

Ravi Chaurey¹, Santosh Kumar², Ajay Kumar³

1&3 MGCGV Chitrakoot, Satna, MP, India,

2 MGCGV Chitrakoot, Satna, MP, India

ABSTRACT

Land Use Land Cover (LULC) change analysis assists decision makers to ensure sustainable development and to understand the dynamics of our changing environment. This research study provides a comparative analysis of land use and land cover (LULC) changes and to investigate the major factors that have caused these changes. Steep topography, shallow soils and monsoonal climatic conditions. A classification system composed of five classes – Agriculture, Built-up, Forest, Waste land and Waterbodies. Digital change detection techniques by using multi-temporal satellite imagery helps in understanding landscape dynamics.

Land use and land cover (LULC) change is a common trend in all parts of the globe. The possible reasons might be economic, political, social or cultural motives. Mapping and monitoring of land use land cover (LULC) changes in part of the Majhagawan Block is vital for sustainable development, planning and management. Based on Remote Sensing and GIS techniques, the study is an attempt to monitor the changes in LULC patterns of part of the Majhagawan Block of Satna district Madhya Pradesh India for the periods 2010-11, 2017-2018. Satellite Images from IRS-P6 LISS-IV 2010 having a resolution of 5m × 5m and WV02 2018 having a resolution of 0.5m × 0.5m and a hand held Garmin12 Global Positioning System receiver. MSI data were used to extract land cover maps. Supervised classification using Maximum Likelihood Classifier (MLC) was applied to prepare LULC maps of the study area. Results shows built-up area and waste land have increased by 0.299% (494.73 Ha), 3.101% (5127.19 Ha) while open forest, agriculture, forest and waterbodies have decreased The area statistics of Land Use/ Land Cover classes of an area is very important for future development.

Keywords: Remote Sensing and GIS, Image Classification, Land Use and Land Cover Change, Accuracy Assessment, Spatiotemporal Pattern, Thematic Maps.

SUSTAINABLE AGRICULTURE AND RESOURCE MANAGEMENT: PROSPECTS AND CHALLENGES
MANJEET SINGH

Chaudhary Charan Singh Haryana Agricultural University (CCS HAU), Hisar, India

ABSTRACT

Farming is a profession of hope and reflects the doubt of uncertainties in agriculture. In India, Agriculture employs about 50 percent of nation work force and provide livelihood for majority of population. India is caught between national demand of food at an affordable price and generating necessary income to provide basic amenities for majority of its population. Keeping this in view, sustainability in agriculture through resource conservation technology is the most pertinent solution to subdue this stint. Globally, the emerging challenges in agriculture are also due to excessive exploitation of fresh water in agriculture as irrigation, impoverished soil, reduction in land holdings, climate etc. Spearheading for smart farming through water management, integrated farming system (IFS), farm mechanization, integrated nutrient management (INM), climate smart cropping is the immediate need of the hour. Besides, the disposal of paddy residue is the major challenge among agrarians. Hence, paddy residue management is of another utmost importance as it contains nutrients and improves soil-plant-atmospheric continuum. The agricultural waste opens vivid options for its versatile usage and is possible if residue is collected and managed properly. Integrated farming system should be followed and conservation agriculture needs to be practiced, as through zero tillage, stubble management, which will increase the yield with sustainability. Farmers have to adopt climate smart cropping. Youth as pivot, entice sustainability vis-à-vis food security. The level of sustainability thus can be enhanced with inclusive efforts.

Keywords: Sustainability, resource management, climate smart cropping, youth

Doubling the Farmers’ Income by adopting an innovative Mushroom Cultivation Practices.

***Sunil Kumar¹, Sushil Kr Sharma¹, Arbind Kr Verma¹, Sandeep Rastogi¹ and P K Rai²**

¹*Krishi Vigyan Kendra (ICAR-DRMR), Gunta Bansur 301 402 Alwar, Rajasthan*

²*ICAR-Directorate of Rapeseed-Mustard Research, Bharatpur 321 303, Rajasthan*

ABSTRACT

Krishi Vigyan Kendra has mandate to provide the innovative idea to the farmers and rural youth for their income generation and employment creation in his jurisdiction area. It has the nutritional and medicinal value, may be cultivated by the land less farmers & farm women. Rural youth, labour and anyone who wants to grow the mushroom. Keeping in mind, the KVK has accompanied the training program on mushroom production. The innovative and small farmer after taking the training in year 2019, he started the mushroom production in small unit size 20X40 Sq ft. and produced the 800 kg oyster and button mushroom and earned Rs. 96000.0/- after investing the Rs 45000/- and net return was Rs. 51000/-. In 2nd year 2020-21 he increases the mushroom farm size of 70X 70 sq. ft. for button mushroom cultivation and invested the Rs 2.5lakh/- on preparation kachcha hat along with other components (bamboo, thread, Mustard straw, spawn, labour and polythene for mushroom packing). He makes the compost of 250-300 quintal from soaking the mustard straw with other raw materials through Long Method of composting. After spawning of the compost @ 700-800g/kg compost, he harvested the 2500kg fresh button mushroom during the season. He sold the button mushroom as fresh and as well as mushroom pickles *in local market and NCR*. From this earned Rs 3.75 lakh/- in 3-4 months of growing season. Due to Covid 19 pandemic many rural youth/ *farmers* are motivated and visited *to his mushroom farm and gathered the information. He has work as Mushroom mitra in local people and* disseminated the technology among the fellow farmers or rural youth (> 20 farmers) of this area. So that mushroom cultivation assisted in doubling the income of farmers and generating the employment in area also.

Assessment of Integrated Pest Management Technology in Bt. Cotton at Farmers’ Fields through On Farm Testing (OFTs).

Sunil Kumar¹, Bajrang Lal Ola¹, Sandeep Kr Rastogi¹, Sushil Kr Sharma², BS Rathore³ and P K Rai⁴

¹⁻²Krishi Vigyan Kendra (ICAR-DRMR), Gunta-Bansur, Alwar 341 401, (Rajasthan) India.

³Krishi Vigyan Kendra (ICAR-CAZRI), Jodhpur, 342 005 (Rajasthan) India.

⁴ICAR- Directorate of Rapeseed-Mustard Research, Bharatpur, 321 303(Rajasthan) India.

ABSTRACT

Cotton (*Gossypium hirsutum* L.) is one of the principal commercial crops belonging to the family Malvaceae. It is also called as cash crop which playing a key role in Indian economic, social and political affairs of our country. In Alwar district of Rajasthan, Cotton (Bt.) is growing in an area 0.53 Lakh ha with annual production 25670 tons and productivity 485kg/ha (POP 2018; Bharatpur khand, Zone 3-B). Farmers were very keen to growing the cotton (Bt.) but this crop is infested with sucking pest viz. aphids, jassids, white fly, thrips, staining insect dusty cotton bug & red cotton bug and diseases like root rot & bacterial blight, etc. Due to these insect pest and diseases farmers may suffered up to 100 % crop losses. Keeping in view, On farm testing (OFTs) were conducted during kharif season 2016 and 2017 in an operational area of Krishi Vigyan Kendra (ICAR-DRMR) Gunta, Bansur, Alwar, Rajasthan to assess the technology along with Integrated Pest management (IPM) in cotton at farmers’ fields in 3 villages. All the farmers were trained on various aspects of cotton crop production and insect pest and disease management. Among the 3 treatments, the treatment T₃ (IPM); Soil application of 3.0 kg *Trichoderma viride* mixed in 250- 300kg of FYM along with seed treatment @ 4g/kg of seed + First 2 spray of neem oil 0.03% EC @ 3-5ml/l up to 70 DAS + spray of Copper oxychloride 3.0 g + Streptocyclin 120 ppm at 80-90DAS + 1 spray of Imidacloprid 17.8% SL @ 0.5ml/ L of water 90-120 DAS i.e. Square/ball formation stage. The treatment T₃(IPM) recorded minimum mean population of aphids, thrips, leaf hopper and white fly were 3.08, 3.25, 1.58/ 3 leaves and 1.75/ 3 leaves and maximum per cent reduction 47.08, 68.29, 71.98 and 83.19, respectively the Farmers’ practice followed by treatment T₂(Non IPM) the mean population were 3.17, 3.33, 2.00 / 3 leaves and 2.50 / 3 leaves and per cent reduction were 45.53 , 67.52 , 64.54 and 75.98, respectively. Whereas Farmers’ practices, the mean population were 5.82, 10.25, 5.64 and 10.41, respectively. Similarly, minimum root rot/wilt incidence (3.00 %) and bacterial blight(3.08%) and maximum disease control 89.28% and 73.63% ,respectively were recorded in treatment T₃(IPM) followed by treatment T₂(Non IPM) disease control was 78.86% and 40.06%, respectively as compare to Farmers Practices the wilt complex incidence(28.00%) and bacterial blight(11.68%). The Significantly maximum average yield of seed cotton was 23.4 q/ha recorded in treatment T₃ which is 38.5% higher than Farmers Practices (16.9q/ha) and cost of cultivation Rs 40056/- & cost benefit ratio was 3.04 recorded in T₃.

Little millet (*Panicum sumatrense*) varieties performance to different levels of fertility in rainfed mid hills of Himalaya.

Ajay Kumar¹, Arunima Paliwal¹, Amit Kishore¹, Sukanya TS², Shikha³ SB Singh⁴

¹Department of Agronomy, College of Forestry, V.C.S.G. Uttarakhand University of Horticulture and Forestry, Ranichauri, Tehri Garhwal, Uttarakhand, India

²Project coordinating Unit, AICRP-Small Millet, University of Agricultural Sciences, Bengaluru

² Krish Vigyan Kendra, College of Forestry, V.C.S.G. Uttarakhand University of Horticulture and Forestry, Ranichauri, Tehri Garhwal, Uttarakhand, India

³Department of Agronomy, College of Agriculture, Banda University of Agriculture and Technology, Banda, Uttar Pradesh, India

ABSTRACT

The little millet crop is predominantly being cultivated in tribal belt of Madhya Pradesh, Chhattisgarh and Andhra Pradesh. It does not have any area under cultivation in Uttarakhand. To know the potential of little millet in mid hills of Himalaya, a field experiment was conducted during *Kharif* season of 2020-21 at College of Forestry, V.C.S.G. Uttarakhand University of Horticulture and Forestry, Ranichauri, Tehri Garhwal, Uttarakhand, India. The experiment consisted of two factor viz. variety and fertilizer. The experiment had four fertility levels viz. 50 % RDF, 100% RDF and 150% RDF and four varieties viz. LMV 528, LMV 536, BL 9 and LK-8. Therefore, there were sixteen treatment combinations. The four fertility levels were

3rd International Conference on “Global Initiative in Agricultural, Forestry and Applied Sciences for Food Security, Environmental Safety and Sustainable Development (GIAFAS-2021)”

laid out in main plot and four varieties were in sub plots of split plot design along with three replications. It was observed that little millet crop would be grown successfully in the mid hills of Uttarakhand. The significantly higher grain and straw yield was recorded under 150% RDF than 100% and 50% RDF. Higher B:C ratio was also recorded in 150 % RDF. Among the tested varieties LMV 528 recorded significantly higher grain and straw yield along with maximum harvest index. Though crop can be grown successfully in mid hills but it is not economically viable as B: C ratio is lower. Therefore, there is need to develop location specific package of practices to make crop more economical for farmers.

POLYSACCHARIDE PRODUCTION AND NITRATE REDUCTION BY BLACKGRAM RHIZOBIAL STRAINS RELATING TO NITROGEN FIXING ABILITY

Diptimayee Dash*

Department of Agricultural Microbiology, Indira Gandhi KrishiVishwavidyalaya,Raipur, 492012 (C.G.), Indi

ABSTRACT

In consideration of economic and environmental aspects of using large amounts of chemical N fertilizers, biological nitrogen fixation is of paramount importance in agriculture. Soil acidity is the one of the factors which restricts production of pulses by restricting nodulation, N fixation and limiting *Rhizobium* survival and persistence in soils. These constraints lead to sub optimal productivity of legume crops raised in acid soils; consequently it becomes inevitable to inoculate the crop with adequate effective *Rhizobium*. Therefore, the present study was undertaken to screen rhizobial isolates of black gram to find out most promising and low pH tolerant ones for enhancing black gram productivity in acid soil of Chhattisgarh. The study comprised of screening of 106 black gram-*Rhizobium* isolates on the basis of acidity tolerance behaviour in order to select microbial strains capable to survive and function in acidic soil condition of Chhattisgarh. Screened promising 12 different acidity tolerant blackgram rhizobia strains including one standard strain (IARI; Urd-10-B) were characterized under laboratory condition for their polysaccharide production and nitrate reduction. The correlation of these physiological properties with their nitrogen fixing ability was established through a field experiment conducted in 2016 with 14 treatments including 12 screened acid tolerant black gram rhizobial isolates, one national check (U-10-B) and one uninoculated – control in blackgram cv. KU-96-3. All 12 promising AT isolates showed a positive nitrate reduction test that the accumulation of nitrite was continuous after growth of rhizobial isolates in nitrate broth leading to a color change from creamy to red colour. Nitrate reduction by the various promising acid tolerant isolates was observed by adding reagents sulfanilic acid and alpha-naphthylamine after inoculation and incubation of cultures in nitrate broth for 24 to 48 hours. As the nitrite accumulation occurs in the growth medium, the colour of the medium changed from creamy to red colour. It has been reported that bacteroids could utilize ATP originating from nitrate respiration to fix nitrogen. Such an adaptation would be especially profitable to bacteroids at times of stress condition, restricted aerobic respiration, caused by, e.g. acidic, draught or flooding of the root zone. Amount of nitrite accumulation (8.08 mM) was observed as maximum with the strain Rhi KU34 and the minimum amount (5.12 mM) was accumulated by the strain Rhi KU13 when growth was occurred for 120 hours. The rhizobial strains produced varying amounts of extracellular polysaccharides with different carbon sources ranging 177.44 mg l⁻¹ to 286.19 mg l⁻¹ in mannitol as C source. In general, all the strains produced maximum polysaccharide with mannitol as carbon source as compared to glucose. The strain RhiU3415 produced maximum amount of polysaccharide (286.19 mg l⁻¹) in mannitol, whereas the lowest amount of polysaccharide (177.44 mg l⁻¹) was formed by Rhi KU40. In glucose maximum polysaccharide i.e. 270.86 mg l⁻¹ was produced by strain Rhi U3415 and the minimum amount was produced by Rhi U 3516 (141.63 mg l⁻¹). On the basis of efficiency ratio at harvest, the strains Rhi KU34, Rhi KU40 and Rhi U3516 seemed to be most efficient in N₂ fixation in symbiosis with black gram (Comparable to standard strain U-10-B) followed by Rhi U137, Rhi KU20, Rhi U1511 and Rhi UKh2. The efficiency ratios of the strains at harvest showed a significantly positive correlation with nitrate reduction by AT strains measured as nitrite accumulation in broth at the end of 120 hours of growth. Whereas production of polysaccharides in different carbon sources was not positively correlated with efficiency. Hence the ability of Blackgram rhizobia to reduce nitrate may be taken as a test to screen effective strains.

Key words : Black gram, rhizobial strains, Nitrate reductase, Polysaccharide production, Efficiency ratio

Genetic parameters and association study of the mutant M₄ population of *Pogostemon cablin* Benth. created through induced mutation.

Sudin Kumar Pandey^{*a,b}, Neelav Sarma^{a,b}, Manabi Paw^{a,b}, Sangeeta Bhandari^b, Twahira Begum^{a,b}, Mohan Lal^{a,b}

^aAcSIR-Academy of Scientific and Innovative Research, Ghaziabad, UP, India.

^bAgrotechnology and Rural Development Division,

CSIR-North East Institute of Science and Technology (NEIST), Jorhat

ABSTRACT

Patchouli (*Pogostemon cablin* Benth.) belongs to the mint family (Lamiaceae). It is a perennial herb native to South and South East Asia. It has high demand in aroma, cosmetic and high-quality perfumery industry. Plant is cultivated through vegetative propagation. Yet very few limited research had been carried out in the improvement of Patchouli. In present study artificial variability was created through induced mutation (physical and chemical mutagen). The agromorphological diversity, correlation and association study for 11 traits among 200 genotypes of M₄ population was carried out. In the present investigation phenotypic coefficient of variation (PCV) value was found to be higher than genotypic coefficient of variation (GCV). Genotypic and phenotypic coefficient revealed that plant height has significant and positive correlation with number of branched sympodia, number of monopodia and patchouli alcohol percentage. Number of branched sympodia was significantly and positively correlated with number of monopodia, essential oil percentage and patchouli alcohol percentage. Another trait, herbage yield/plant had significant and positive correlation with dry weight of herbage yield/plant. In path coefficient analysis for dry herbage yield/plant, it was observed that herbage yield/plant has highest positive direct effect on dry weight of herbage yield/plant, accompanied by other trait such as length of monopodia, leaf length, length of sympodia and leaf width. Whereas, herbage yield has indirect correlation with dry herbage yield via leaf length. Essential oil percentage matrix revealed that highest and direct effect on essential oil percentage was found to be in length of monopodia, followed by herbage yield, number of monopodia, leaf length and leaf width. Length of monopodia has indirect correlation with essential oil percentage via number of monopodia. Based on the study selected genotypes can be used in further breeding program and high essential oil yield germplasm can be used in commercial purposes.

Keyword: *Pogostemon cablin* Benth., Induced mutation, correlation, association study, Path analysis.

Chemical profiling of essential oil among germplasm of *Zingiber officinale* Roscoe collected from Northeast India

Twahira Begum^{*1,2} and Mohan Lal^{1,2}

¹ Agrotechnology and Rural Development Division CSIR-North East Institute of Science and Technology (NEIST), Jorhat

² Academy of Scientific and Innovative Research (AcSIR), Ghaziabad-201002, India

ABSTRACT

Zingiber officinale Roscoe belonging to the family Zingiberaceae is an important cash crop commonly used in the fresh form. Apart from that, ginger is dried and exported globally for its economic importance. The aroma and flavor of ginger can be attributed to the presence of essential oil. They find numerous uses in medicine with indications against several problems, such as a cure for swelling, diarrhoea, sores, stomach ache, and loss of appetite, gingivitis, tooth ache, arthritis, asthmatic respiratory disorders also possessing anti-inflammatory activity. In the present study a total of 150 germplasm were collected and selected for the study for chemical profiling of the essential oils. The profiling of the essential oils was done using GC/MS which were extracted by hydro-distillation using Clevenger apparatus. A total of 21 chemical markers were identified in the ginger essential oil. The major active compounds were found to be zingiberene, camphene, neral, geranial, eucalyptol and geraniol. The highest zingiberene was found to be present in the germplasm Z-482 (23%). While highest 3camphene was recorded in Z-300 (18.09%), highest neral in Z-427 (21.91%), highest geranial in Z-427 (40.35%), highest eucalyptol in Z-442 (19.81%) and highest geraniol in Z-343 (12.14%). The germplasm possessing high zingiberene can be

3rd International Conference on “Global Initiative in Agricultural, Forestry and Applied Sciences for Food Security, Environmental Safety and Sustainable Development (GIAFAS-2021)”

considered as good germplasm. The variability in the composition in the essential oil of the 150 germplasm of ginger would further pave the way for selection of ginger germplasm with superior trait in terms of chemical composition.

Assessment of variability and correlation studies among 150 germplasm of *Zingiber officinale* Roscoe collected from Northeast India

Twahira Begum^{*1,2} and Mohan Lal^{1,2}

¹ Agrotechnology and Rural Development Division CSIR-North East Institute of Science and Technology (NEIST), Jorhat

²Academy of Scientific and Innovative Research (AcSIR), Ghaziabad-201002, India

ABSTRACT

Zingiber officinale Roscoe commonly known as ‘Ginger’ belonging to the family Zingiberaceae of the order Zingiberales is an herbaceous perennial plant. It is commonly used in its raw form and also as a spice in daily use. In Northeast India region, the ginger productivity was highest in Mizoram, followed by Arunachal Pradesh, Assam and Nagaland, although Assam ranks first in ginger acreage. The cultivated ginger in the North East region of India is reported to have the maximum variability. In the present study a total of 150 germplasm were selected for the study. These selected lines were planted in RCBD with three replications during *kharif* 2019 and *kharif* 2020. Pooled data of two year studied were used for the estimation the variability parameters, association study and path analysis. Analysis of variance showed that the genotype used in the study significantly differ from each other for all the characters under study revealing high variability among them. PCV (Phenotypic coefficient of variation) was found be slightly higher than GCV (Genotypic coefficient of variation). Highest GCV, PCV along with high heritability with high genetic advance was depicted in rhizome weight indicating high variability due to additive genes action which makes it useful in selection program. Based on the genotypic and phenotypic correlation, the number of tillers per plant was found to be significantly and positively correlated with rhizome weight. However, the essential oil yield was negatively correlated with rhizome yield. The present investigation aims to estimate the variability parameters, and correlation among the germplasm of *Z. officinale* which will help in the development of future strategies in the crop improvement, breeding plan, conservation and varietal development for commercial cultivation of this industrially important crop. This is the first report of 150 germplasm studies with two year evaluation.

Molecular study using RAPD and ISSR marker based on selection of M₄ population of *Pogostemon cablin* Benth.: Through Induced mutation.

Sudin Kumar Pandey^{*a,b}, NeelavSarma^{a,b}, Manabi Paw^{a,b}, Sangeeta Bhandari^b, TwahiraBegum^{a,b}, Mohan Lal^{a,b}

^aAcSIR-Academy of Scientific and Innovative ResearchGhaziabad, UP, India.

^b Agrotechnology and Rural Development Division,

CSIR-North East Institute of Science and Technology (NEIST), Jorhat Assam-785006, India

ABSTRACT

Patchouli (*Pogostemoncablin*Benth.) which is a perennial herb is the member of Lamiaceae family. This species is highly used in different medicinal purposes and also in perfumery industries. The leaves of *P. cablin*yield aromatic oil, which is highly valued in perfumery and aroma therapy because of its dominant aromatic spicy fragrance. As there is no synthetic chemical to replace the complex patchouli essential oil constituents, its market value has further enhanced, especially for the aroma industries. In this present study artificial variability has been created through induced mutation. Genotypes were selected based on treatment and morphological characters from M₄population. Molecular study was carried out using RAPD

3rd International Conference on “Global Initiative in Agricultural, Forestry and Applied Sciences for Food Security, Environmental Safety and Sustainable Development (GIAFAS-2021)”

and ISSR molecular markers. 87.5% polymorphism was found in RAPD and 80% polymorphism in ISSR markers. The polymorphism study is important in selection of superior germplasm that will produce higher herbage yield, patchouli alcohol percentage and high essential oil yield. This study can be helpful for further breeding program and will help in selection of best genotypes.

Keywords: *Pogostemon cablin* Benth., Molecular study, RAPD and ISSR marker.

STANDARDISATION, SHELF LIFE STUDY AND NUTRIENT COMPOSITION OF THE BEETROOT ENRICHED KODO MILLET PASTA

SAROJANI J K^{1*}, SUVARNA C H² AND SNEHA S³

1 ICAR NAE Project, Department of Food Science and Nutrition, College of Community Science, University of Agricultural sciences, Dharwad, Karnataka, India – 580005

2,3 ICAR NAE Project, Department of Food Science and Nutrition, College of Community Science, University of Agricultural sciences, Dharwad- 580005

ABSTRACT

Kodo millet is a tropical small millet crop, indigenous to India and grown for grain fodder purpose. Kodo millet is highly nutritious and a good substitute to rice or wheat. Kodo millets are rich in B vitamins, especially niacin, B6 and folic acid, as well as the minerals such as calcium, iron, potassium, magnesium and zinc. Beetroot has numerous health benefits due its chemical composition, such as fibre, vitamins, minerals, phenolic compounds and Betalians. The antioxidant properties of beetroot help in preventing cancer and beneficial for cardio-vascular diseases. It is used as natural colouring agent in several products. Realizing the awareness of the consumers towards the nutritional and health constituents present in processed products, the study was conducted to develop the beetroot enriched kodo millet pasta which could serve the nutritional needs, by providing health promoting properties from developed product. In the present study kodo millet pasta enriched with betalians as natural colorant from beetroot was done by varying the proportions of beetroot fine pulp, coarse pulp and dehydrated powder. The optimized product studied for stability during storage. Results revealed that the pasta can be stored up to five months without any quality deterioration of the product. The nutrient analysis illustrates that 100 g sample of beetroot enriched kodo millet pasta contains 10.50 per cent moisture, 9.88 per cent protein, 1.80 per cent fat, 1.62 per cent crude fiber, 1.28 per cent ash, 76.54 per cent carbohydrates, 1.25 mg of iron, 2.28 mg of zinc and 40.57 mg of calcium.

POTENTIAL OF PSEUDOSTEM OF *Musa Bulbasiana* Colla AS A POTENTIAL NATURAL HEALTH SUPPLEMENT

Priyanka Bhattacharyya

Assam Agricultural University, Assam

ABSTRACT

Musa Bulbasiana Colla, commonly known as Bheem kol in Assam, is an indigenous variety of banana grown in the state. The pseudostem of the banana variety is an important component of the Assamese cuisine. Owing to its exotic essence, it is popular in both household as well as commercial culinary delicacies. The pseudostem also has wide acceptance as a traditional medicine in Assamese culture. The present study is intended to brief out the pertinent practices on the use of the pseudostem of *Musa Bulbasiana* Colla in health and disease as per traditional Assamese culture. A qualitative interview is conducted among the Assamese community residing in Tinsukia and Dibrugarh districts of Assam. Standardised

3rd International Conference on “Global Initiative in Agricultural, Forestry and Applied Sciences for Food Security, Environmental Safety and Sustainable Development (GIAFAS-2021)”

questionnaire is designed to obtain the data. The Assamese community regards the pseudostem of the banana variety to have immense significance in health. It is consumed widely for the treatment of urinary disorders, stomach difficulties like diarrhoea, dysentery and flatulence. The pseudostem is also considered as a natural regulator of metabolic syndromes such as obesity, high blood sugar, high blood pressure and high cholesterol. The study extrapolates the necessity to conduct extensive scientific research on the potential of the pseudostem of *Musa Bulbasiana* Colla as a natural health supplement.

Development and Performance Evaluation of Solar Operated Plot Thresher for Chickpea

Naveen Kumar* and Ajay Kumar Sharma¹

Department of Farm Machinery and Power Engineering, CTAE, MPUAT, Udaipur

ABSTRACT

A solar operated plot thresher for chickpea crop was developed based on the physical and mechanical properties of chickpea seeds and plants to mechanize the threshing of chickpea research plots. The thresher was evaluated at different levels of independent parameters *viz.* cylinder speed (8, 10, 12 m/s), concave clearance (10, 12, 14 mm) and concave grate clearance (8, 9, 10 mm). The effects of independent parameters on threshing efficiency, cleaning efficiency, seed damage, threshing capacity, power consumption and seed germination were studied. Response Surface Methodology (RSM) with Face Centered Central Composite Design (FCCCD) was used in designing the experiments for optimization. The effect of cylinder speed was found to be the most significant. With increasing cylinder speed from 8 to 12 m/s, the threshing efficiency and seed damage increased from 99.45 to 99.99 % and 0.30 to 1.31 %, respectively. With increasing concave clearance (10 to 14 mm) and concave grate clearance (8 to 10 mm), threshing efficiency and seed damage decreased from 99.45 to 99.22 % and 0.30 to 0.11 %, respectively at constant cylinder speed of 8 m/s. The interactional effects of cylinder speed with concave clearance and cylinder speed with concave grate clearance were highly significant on seed damage and threshing capacity at 1 per cent level of significance. At optimized condition, the values of dependent parameters *viz.* threshing efficiency, cleaning efficiency, seed damage and seed germination were 99.69, 99.74, 0.19 and 98.08 percent, respectively. The power consumption and threshing capacity were 625.53 W and 31.75 kg/h, respectively.

Keywords: Chickpea, solar, plot, threshing, effect.

INTREGATED NUTRIENT MANAGEMENT

Jay Nath Patel*¹, Mohd Shah Alam¹, Durgesh Kumar²

¹Department of Agriculture, Sardar Vallabhbhai Patel University of Agriculture & Technology, Modipuram, Meerut-250110, (U.P.), India.

²Department of Vegetable Science, Chandra Shekar Azad University of Agriculture & Technology, Kanpur, (U.P.), India

ABSTRACT

The use of combination of chemical fertilizers, organic manures and bio-fertilizers for the nutrition of crop plants is referred as the Integrated Nutrient Management (INM). The aim of INM is to improve and maintain the physical, chemical, biological and hydrological properties of the soils to enhance soil fertility and productivity with minimizing the land degradation. Alleviation of poverty and achievement of zero-hunger target and food security can be achieved by the INM; in fact it has the bright solution in this area. Replacement of a part of chemical fertilizers application by organic manure and bio-fertilizers is practices for INM by simple technique. INM resulted in balanced nutrition to the crops and better nutritional uptake lead to better plant growth and yield. INM minimizes the deterioration of soil, water and ecosystem by promoting carbon sequestration, reducing nutrient losses to ground and surface water bodies and to atmosphere. It also reduces the cost of

3rd International Conference on “Global Initiative in Agricultural, Forestry and Applied Sciences for Food Security, Environmental Safety and Sustainable Development (GIAFAS-2021)”

fertilizer application to the crops, which is helpful to the farmers in crop production. Thus, INM is necessity of crop nutrition for improving and maintaining the various soil properties with its fertility and productivity along with greater crop yield production with better quality traits and maintains satisfactory profit.

Aquaculture: present and future

Mohd Shah Alam*¹, Jay Nath Patel¹, Muzeev Ahmad², Khurshed Alam²

¹Department of Agriculture, Sardar Vallabhbhai Patel University of Agriculture & Technology, Modipuram, Meerut-250110, (U.P.), India.

²Department of Horticulture, Sardar Vallabhbhai Patel University of Agriculture & Technology, Modipuram, Meerut-250110, (U.P.), India.

ABSTRACT

Aquaculture production is developing increasingly in the world and, as years go by is becoming a viable alternative to the exhaustion of resources from catching fish. Most aquaculture systems rely on low/uncosted environmental goods and services, so a critical issue for the future is whether these are brought into company accounts and the consequent effects this would have on production economics. Freshwater aquaculture can make a significant contribution to bridging the widening gap between demand for and supply of fishery products in Asia, in the face of declining captures fisheries production and growing populations. First, many types of aquaculture depend on capture fish for fish meal, the choice of fish species that can use essentially vegetarian food produced on the spot is an important element to ensure long-term viability. Secondly, the fact that fish produced can be sold on local and regional markets which decrease the dependence on international markets where constraints associated with changing standards are increasing. Sustainable development policies are needed that address use of natural resources, research, inputs and outputs and pricing, as well as problems in marketing, credit, trade, investment and exchange rates. Countries with extensive and traditional fish culture practices (Bangladesh, India, and Thailand) should encourage intensive use of inputs to move to semi-intensive fish culture

Role of Indigenous Technical Knowledge (ITK) for Sustaining Grassroots Innovations

Kawita Bhatt¹, Pooja Karki², Piyush Choudhary³

^{1&2}Department of Agricultural Communication, College of Agriculture, GBPUAT, Pantnagar, Uttarakhand

³Department of Agronomy, Rajasthan College Of Agriculture, MPUAT, Udaipur (Raj.)

ABSTRACT

India is a country with many indigenous communities that follow different farming practices and possess unique traditional knowledge and has built local technologies. These technologies are used specifically by one or two communities but have immense potential for innovation. These location specific knowledge and technologies are known as Indigenous Technical Knowledge (ITK). These traditional knowledge and technologies have played a significant role in the overall socio-economic development of the communities. There is an instant need to document and preserve the Indigenous Technical Knowledge (ITK) of different communities, many of which are at the brink of extinction. There is a lack of proper alliance between the practice of indigenous and modern knowledge. A suitable combination of the traditional and modern knowledge and technology systems has immense potential to benefit the society.

Keywords: Indigenous Technical Knowledge, socio-economic development, documentation.

Performance of *Rhizobium* strains on available nutrients and rhizobial population of pigeonpea in Vertisol

Kavita Soni , R.K.Sahu*, Bablu Yaduwanshi , N.G. Mitra and S.S. Baghel

Department of soil science and Agricultural Chemistry, Jawaharlal Nehru Krishi Vishwa Vidhyalaya, Jabalpur, Madhya Pradesh-482004, India

ABSTARCT

A field experiment was laid on Performance of *Rhizobium* isolates on available nutrients and rhizobial population of pigeonpea in Vertisol at the Department of Soil Science, JNKVV, Jabalpur with twelve treatments (6 exotic, 2 local strain, FUI, UFUI and two Maize control) with four replication laid out in randomized block design. These isolated were applied as

3rd International Conference on “Global Initiative in Agricultural, Forestry and Applied Sciences for Food Security, Environmental Safety and Sustainable Development (GIAFAS-2021)”

a seed treatment (@ 10 ml kg⁻¹ of seed). The outcome of the study revealed that among different *Rhizobium* isolates, R1 (BRP20) exhibited the best performance for content of available nutrients (N, P and K) in soils of pigeonpea at post harvest by 18%, 63% and 21.66% over that of FUI. The microbial population in rhizospheric soil of pigeonpea increased at 25, 45, 65 and 85 DAS by 69, 56, 36 and 54.84 fold over that of FUI (Fertilized un inoculated) . For almost every parameters, the treatment of R2 (BRP28), RL1, RL2, R3 (BRP56), R4 (BRP2), R5 (BRP4) and R6 (BRP8) exhibited the performance of next group. While, the variability in available content of nutrients (N, P and K) and native rhizobial population in soil of maize (a non-leguminous crop) was due to the effects of fertilization apparent in direct and reciprocal manner, respectively. The *Rhizobium* isolates beside an effective diazotroph are also beneficial rhizobacteria which upon inoculation on seeds of pigeonpea additionally benign to direct as well as indirect ways viz., nutrient solubilization, siderophore formation for Fe availability, excretion of growth promoting enzymes (IAA, GA, ABA, cytokinin, etc.) and anti- oxidants against phytopathogens, ACCD activity and systemic resistance (ASR and ISR) for effective nodulation, vigorous plant growth, efficient uptake of nutrients and production of cost effective crop yields all with sustainable agriculture.

Kew words: *Rhizobium*, pigeonpea, JNKVV, systemic resistance

Effect of *Rhizobium* inoculants on growth stages and yield of pigeonpea in Vertisol **Kavita Soni , R.K.Sahu, S.S. Baghel*, Bablu Yaduwanshi and N.G. Mitra**

Department of soil science and Agricultural Chemistry, Jawaharlal Nehru Krishi Vishwa Vidhyalaya, Jabalpur, Madhya Pradesh-482004, India

ABSTRACT

A research trail was conducted on Effect of *Rhizobium* strains on growth stages and yield of pigeonpea in Vertisol at the Department of Soil Science, JNKVV, Jabalpur (M.P.) There were twelve treatments (6 exotic, 2 local strain, FUI, UFUI and two Maize control) with four replication laid out in randomized block design. These isolated were applied as a seed treatment (@ 10 ml kg⁻¹ of seed). The result shown that *Rhizobium* strain R1 (BRP20) performed best in pigeonpea at different growth stages (25, 45, 65 and 85 DAS) for nodulation attributes (nodule enumeration, its biomass and leghemoglobin content) by 72.00, 75.00, 60.00 and 34.00%; 63.50, 19.00, 10.30 and 9.70%; and 60.00, 69.00, 72.00 and 69.00% over that of fertilized un inoculated (FUI); plant growth attributes (plant height and its biomass) by 69.30, 20.90, 22.45 and 24.10%; and 64.70, 31.70, 23.70 and 13.70% over that of FUI; leaf chlorophyll content by 48.47, 65.30, 54.00 and 72.00% over that of FUI; uptake of nutrients at harvest (N, P and K) by 43.00, 71.00 and 66.00% (in seeds) and 58, 72 and 18% (in stover) over that of FUI and harvest yields (seed and stover) by 16 and 12% over FUI, respectively. The variations on plant parameters for maize crop availing only native microbial benefits were apparently due to genetic attributes of the crop with implication of native microbial influence especially soil existing *Rhizobium* sp. in the present context and along with that from fertilization.

Kew words: *Rhizobium*, pigeonpea, growth stages, native microbial, Vertisol

Development of avirulence genes-based multiplex PCR to identify black rot disease in cauliflower **Amit K. Kesharwani^{1,2*}, Dinesh Singh¹, Anupama S. Avasthi²**

¹*Indian Agricultural Research Institute, New Delhi, India*

²*Amity Institute of Biotechnology, Amity University, Noida, India*

ABSTRACT

Xanthomonas campestris pv. *campestris* (Xcc) is a gram-negative bacterium that infects cruciferous crops and producing black rot disease, occurs worldwide. This research is focused on to the development of a rapid assay to identify black rot disease based on *avr* genes viz. *AvrXccC*, *AvrBsI*, and *AvrGfI* that involved in pathogenicity and host specificity by multiplex-PCR method. These *avr* genes are located in different regions in Xcc genome (*AvrXccC* -4294677-4296251; *AvrBsI*- 2481228-2482565; *AvrGfI*-2492436-2493431) and very important to detect the black rot disease at the molecular level. Three Indian races of Xcc i.e., races 1, 4, and 6 from infected biological samples of cauliflower were identified by multiplex-PCR in a single reaction. The primers specificity of multiplex PCR of 3 *avr* genes was characterized by the amplification of *avr* genes with other bacterial species viz. *Xanthomonas euvesicatoria*, *X. oryzae* pv. *oryzae*, *Pseudomonas*

3rd International Conference on “Global Initiative in Agricultural, Forestry and Applied Sciences for Food Security, Environmental Safety and Sustainable Development (GIAFAS-2021)”

fluorescens, *Ralstonia solanacearum*, *Bacillus subtilis*, *B. amyloliquefaciens* including 7 isolates of Xcc race 1, 4, and 6. However, the multiplex PCR of three *avr* genes primer pairs only produced amplification with Xcc isolates that indicating the specificity of the primer pairs. The sensitivity of gene-specific primers used for multiplex PCR showed a threshold up to 10pg/μl of gDNA. In this study, this method was helpful to detect black rot causing Xcc directly from the field.

Role of AMMI and GGE biplot in developing of new varieties in changing climatic conditions

Atul Loyal¹, Naval Kishore² S. K. Pahuja¹

¹*Department of Genetics & Plant Breeding, CCSHAU, Hisar, Haryana. (India) (125004),*

²*Hill Agricultural Research and Extension Centre, Bajaura, Kullu, HP-175125*

ABSTRACT

Barley is one of the major rabi crops of northern India. It is grown in irrigated as well as rainfed conditions. The present study was planned and conducted by keeping in view the rainfed conditions of Himachal Pradesh. 21 genotypes of barley were grown across five different locations viz., Malan, Berthin, Kangra, Bajaura and Katrain. Each of them was representative of a different environment. The main purpose of the experiment was to check the stability of the genotypes and identify the stable and superior genotypes using AMMI and GGE biplot analysis. It was reported from the study that there was a significant difference in the performance of genotypes due to G×E interaction. Among the total variation environments explained the most of variation followed by genotypes and genotype × environment interaction (GEI). The ‘which won where’ pattern showed that no single genotype was found stable as well as high yielding for more than one trait. Although Genotype G8 (HBL 812) was found to be superior in terms of biological yield in all environments except Katrain. G8 (HBL 812) was considered as the best performing genotype amidst all environments. The study further indicated that during the developmental phase of a cultivar/variety more emphasis should be given to the environment. AMMI and GGE biplots can play a pivotal role in determining and partitioning the total component of variation into the environment, genotypic and G × E interaction.

Keywords: Barkey, AMMI, GGE biplot, Stability, G × E interaction, Environment

Minimum data set to improve seed and fodder yield in Oat

Priyanka*, V.K. Sood, Sawan Kumar, Amit Rana and Sanjay Kumar Sanadya

Department of Genetics and Plant Breeding, CSK Himachal Pradesh Agricultural University, Palampur-176062, India

ABSTRACT

Minimum data set (MDS) helps in identifying the most relevant characters using multivariate approach that can be used as descriptors by explaining as much of total variation in the original set of variables as possible with a few components as possible and reducing the dimension of the problem. The present investigation was effectuated to analyze diversity in oat genotypes *via* Principal Component Analysis. Two experiments were conducted on same genotypes in order to study the effect of fodder cut (70 days after sowing) to compare the dual purpose and seed yield purpose traits. A total of 76.82%, 80.29% variation explained by the first five principal components in dual purpose traits and variation seed yield purpose systems, respectively. Among dual purpose traits, leaf stem ratio resulted in highest positive value followed by tillers per plant, dry matter percent, β-glucan content and dry matter yield in all the principal components. While, among seed yield related traits, in all principal components, seed yield resulted in highest positive value followed by harvest index, crude protein content, tillers per plant and 100 seed weight. Overall leaf stem ratio followed by tillers per plant, dry matter percent, β-glucan content and dry matter yield result positive value in higher extent. These traits observed as maximum contributors towards genetic divergence. Hence, the selection on the basis of these traits would be effective for improvement of fodder yield in oat.

Key words: Diversity, fodder, oat, principal component analysis

Impact of Heights on Growth, Yield and Quality of Mango cv. Amrapali

Amit Raj¹, Goutam Mandal¹, Sanjay Sahay² and Ravindar Kumar²

¹*Department of Horticulture and Post harvest Technology, Institute of Agriculture, Palli Siksha Bhavana, Sriniketan, Visva-Bharati, West Bengal, India-731236*

²*Department of Horticulture (Fruit & Fruit Technology), Bihar Agricultural College, Sabour, Bhagalpur, India-813210*

ABSTRACT

An investigation on Impact of plant heights on growth, fruit yield and quality of Mango Cv. Amrapali was done at Bihar Agricultural College, Sabour during 2020-2021 to find out the optimal height for fruit production in Mango cv. Amrapali. Six different heights: T₁- 80cm, T₂-100 cm, T₃-120 cm, T₄-140 cm, T₅-160 cm and T₆-180 cm with three replication in a split plot design were taken for investigation. Plant height and spread were measured for estimation of canopy volume, bearing behaviors of plants including physical and quality parameters of fruits were also taken for observation. Plants of T₆(4.79m) recorded maximum growth in height. Maximum growth in plant spread in north-south direction was recorded in T₃ (3.07 m) while maximum growth in plant spread in east- west direction was recorded in T₁ (3.05). The maximum canopy volume (m³) was measured in T₆ (88.62). In flowering characters, early bud break was reported in T₁, minimum days to flowering recorded in T₄ (21.08) while minimum days to 50% flowering recorded in T₂ (27.00). In fruiting characters, minimum days to fruit set recorded in T₂ (35.04) while maximum number of fruits/plant was recorded in T₁ (61). The maximum fruit yield found in T₁ (167.51). In physical parameters, largest fruit weight (268.21g) ,higher pulp content (207.35 g) was recorded in T₁ and maximum stone weight (35.05 g) was recorded in T₂ while maximum peel weight was recorded in T₃ (32.83g). In quality parameters, maximum T.S.S (22.24*B) and minimum acidity (0.19%) was recorded in T₁. From the above findings it can be concluded that the plants with shorter heights (80cm) have high potential in respect to yield and quality and can be adopted for higher yield in high density planting of mango.

Keywords: Mango; amrapali; growth; flowering; yield; quality

Determination of Aquifer parameters by using AQTESOLV-Software

Dimple*, P.K. Singh and K.K. Yadav

Soil and Water Engineering Department, College of Technology and Engineering, MPUAT, Udaipur-313001, Rajasthan, Indian

ABSTRACT

Groundwater inflow/outflow to any area is regulated by several aquifer properties and determination of properties like hydraulic conductivity (K), transmissibility (T), and storativity (S) is essential to ascertain the sustainable well yield. In situ estimation of these properties/parameters is accomplished by conducting pumping tests. Aquifer parameter test delivers vital information to resolve regional and local groundwater flow concerns. In both the confined and unconfined aquifers, there are numerous methods for determination of aquifer parameters. In present research, 10 pumping tests were conducted at different geologic locations in hardrock region dominated watershed to estimate aquifer properties. Method “Papadopulos-Cooper (P-C)” was considered reference and “AQTESOLV (Aquifer Test SOLver)” software methods which includes (Theis method, Cooper and Jacob method, Neuman method and Tartakovsky-Neuman method) were utilised for the estimation of aquifer properties. Results revealed that T values calculated using P-C method varied from 105.1 square meters per day to 322 square meters per day. However, T values estimated employing AQTESOLV ranged from 122 to 300 square meters per day. All approaches using the software gave T values found strongly positively correlated with the P-C method (Curve matching technique).

3rd International Conference on “Global Initiative in Agricultural, Forestry and Applied Sciences for Food Security, Environmental Safety and Sustainable Development (GIAFAS-2021)”

Key words: Papadopulos-Cooper method, AQTESOLV software, Pumping test, Transmissivity, Storativity

ROLE OF SOCIAL MEDIA IN AGRICULTURE MARKETING

Aafreen Malik¹ and Mohammad Aslam Ansari²

Department of Agricultural Communication, College of Agriculture, G. B. Pant University of Agriculture & Technology, Pantnagar-263145, Uttarakhand, India

ABSTRACT

Gradual and regulated expansion of telecommunication infrastructure in India during the last two decades has increased the effective reach of mobile telephony across the entire spectrum of the society. Consequently, mobile telephony has emerged as the technology of choice of masses. The use of social media by farmers has comprehensively transformed the way information is produced, processed and exchanged between different stakeholders in agriculture sector. Farmers are making use of social media such as Whatsapp, Facebook, YouTube, Blogs, Pages, Discussion groups/ Forums, etc. for a variety of purposes – for information, education and entertainment. A number of mobile apps besides many websites and portals are popular among the farmers linking them to markets as well as agribusiness firms.

Timely access and availability of marketing information is very crucial for the farmers as it can substantially affect the farm profitability. It saves time and cost in seeking relevant information about marketing of agriculture produce, supply chain and logistics management. A key benefit of using social media in marketing is the opportunity to establish key partnerships, opportunity to reach wider consumers, and connect with potential buyer besides access to gain wealth of knowledge and ideas. Social media overcomes geographical boundaries and creates communities who share common interests, and can help in branding of agriculture commodities as well as their providers for quality, concern and reliability. Social media can facilitate marketing of farmers’ produce through sending pictures, videos, and links for connecting the potential buyers and sellers, and illuminates the blindspots in the agriculture supply chain management and value addition. The critical challenges in the use of social media for agriculture marketing includes language compatibility, competency in social media use, connectivity/ internet speed and lack of trust in e-buying/ e-selling of agriculture commodities. However, social media platforms can benefit the farmers in developing networks between Farmer-to-Farmer as well as Farmer-to-Agribusinesses, reduce their social isolation by promoting shared communities of specific interests, and enable farmers to trade online thereby reducing the costs, time and minimise the efforts besides increasing the farm incomes.

Key words: Social media, Agricultural marketing and ICT.

Climate Resilient Technologies for Sustainable Food Production in India

D.Balu¹, M. Kavaskar² D.Vengatesan² and E.Suriyapriya¹

Department of Agricultural Extension, Annamalai University

ABSTRACT

Sustainable food production is one of the major challenges of the twenty-first century in the era of global environmental problems such as climate change, increasing population and natural resource degradation including soil degradation and biodiversity loss. Climate change is among the greatest threats to agricultural systems. Green Revolution though multiplied agricultural production several folds but at the huge environmental cost including climate change. It jeopardized the ecological integrity of agro-ecosystems by intensive use of fossil fuels, natural resources, agrochemicals and machinery. Moreover, it threatened the age-old traditional agricultural practices. Agriculture is one of the largest sectors that sustain livelihood to maximum number of people and contribute to climate change. A climate-smart approach to sustainable food production is the need of hour. Traditional agriculture is getting increased attention worldwide in context of sustainable food production in changing climate. From this traditional agriculture as a climate-smart approach for the sustainable food production and also deliberates the correlation between climate change and agriculture.

Keywords: Sustainable food production, Climate change, Traditional agriculture

EFFECT OF FOLIAR NUTRITION ON GROWTH AND YIELD OF COTTON
THIRUPPATHI, M*., S. SELVAKUMAR*, R. REX IMMANUEL*, A. SIVARAMAN AND**

G. ASHOKA

*Department of Agronomy **Department of Entomology,
Faculty of Agriculture, Annamalai University, Annamalai Nagar - 608 002 (T.N)

ABSTRACT

Field experiments were conducted at Ryot's field, Pinnanur village, Thalaivasal Block, Salem District during summer season (March to August, 2020) to evaluate the effect of foliar application of major and micro nutrients along with PPFM on growth and yield of hybrid cotton. The experiment was laid out in randomized block design and replicated thrice. The experiment comprised of twelve treatments of foliar application of nutrients at flowering and boll development stages *viz.*, control (T₁), 2% MgSO₄ (T₂), 2% DAP (T₃), 0.5% borax (T₄), 1.5% K₂SO₄ (T₅), 2% urea (T₆), 1% PPFM (T₇), 2% MgSO₄ + 1% PPFM (T₈), 2% DAP + 1% PPFM (T₉), 0.5% + borax 1% PPFM (T₁₀), 1.5% K₂SO₄ + 1% PPFM and (T₁₁), 2% urea + 1% PPFM (T₁₂). Foliar application of macro, micronutrients and PPFM registered the increased values of growth characters, yield attributes, yield of hybrid cotton over control. Among the foliar application practices tested, foliar application of 2% urea + 1% PPFM at flowering and boll development stages (T₁₂) significantly resulted in increased values of all growth characters *viz.*, plant height (157.40 cm), DMP (6003 kg ha⁻¹), number of monopodial branches (3.28 plant⁻¹), growth analysis like LAI (4.30), CGR (7.01 g m⁻² day⁻¹) and RGR (0.0144 g g⁻¹ day⁻¹), yield attributes *viz.*, number of sympodial branches (21.77 plant⁻¹), number of squares (83.77 plant⁻¹), number of bolls (45.04 plant⁻¹), boll weight (5.58 g) and seed cotton yield (3185 kg ha⁻¹) of cotton. This was statistically on par with the foliar application of 2% MgSO₄ + 1% PPFM at flowering and boll development stages (T₈). The lower values of growth characters, yield attributes and yield were recorded under control treatment (T₁). Based on the results of present investigation, it can be concluded that foliar application of 2% urea + 1% PPFM at flowering and boll development stages (T₁₂) pave the way for achieving better growth of cotton and realizing higher seed cotton yield.

Key words: Cotton, PPFM, Urea, growth and yield.

EFFECT OF BIOFERTILIZERS AND INORGANIC FERTILIZER ON YIELD ATTRIBUTES AND ECONOMICS OF BLACKGRAM (*Vigna mungo* L.)

Thiruppathi, M*., Gudapati Ashoka Chakravarthy R. Rex Immanuel*** and S. Selva Kumar******

Department of Agronomy, Faculty of Agriculture, Annamalai University, Annamalai Nagar, Tamilnadu, India.

ABSTRACT

Field experiments were carried out during Rabi season 2019 - 2020 at Annamalai University Experimental Farm, Department of Agronomy, Faculty of Agriculture, Annamalai University to find out the effect of foliar application of nutrients on the yield and economics of blackgram. The experiment was laid out in Randomized Block Design with 13 treatments and replicated thrice *viz.*, T₁ – Control, T₂ – Rhizobium as seed treatment, T₃ – Pink Pigmented Facultative Methylophilic Bacteria (PPFMB) as seed treatment, T₄ – PPFMB as foliar spray, T₅ – 2% DAP as foliar spray, T₆ – Rhizobium as seed treatment + 2% DAP as foliar spray, T₇ – PPFMB as seed treatment + 2% DAP as foliar spray, T₈ – Rhizobium as seed treatment + PPFMB as foliar spray, T₉ – PPFMB as seed treatment + PPFMB as foliar spray, T₁₀ – Rhizobium as seed treatment + 2% DAP foliar spray + PPFMB as foliar spray, T₁₁ – Rhizobium as seed treatment + PPFMB as seed treatment + 2% DAP as foliar spray, T₁₂ – Rhizobium as seed treatment + PPFMB as seed treatment + PPFMB as foliar spray and T₁₃ – Rhizobium as seed treatment + PPFMB as seed treatment + 2% DAP as foliar spray + PPFMB foliar spray. The yield attributes such as number of pods plant⁻¹, number of seeds pod⁻¹, test weight and grain and haulm yields (kg ha⁻¹) were

3rd International Conference on “Global Initiative in Agricultural, Forestry and Applied Sciences for Food Security, Environmental Safety and Sustainable Development (GIAFAS-2021)”

observed. Further economics of black gram cultivation were also worked out. Seed treatment with PPFMB @ 1% recorded the maximum yield attributes and yields over seed treatment with rhizobium and control. However foliar application of PPFMB @ 1% at 30DAS (50% Flowering) stages proved its superiority by registering maximum values of yield contributing characters and yields. The combined use of PPFMB as 1% seed treatment followed by foliar application 1% at 30DAS (50% flowering) stages noticed the highest number of pods plant⁻¹, number of seeds pod⁻¹, test weight, seed yield and haulm yields. The same treatment combination caused the highest economic returns. Based on the results of the present study it is concluded that seed treatment with PPFMB @ 1% followed by foliar application of PPFMB @ 1% at 30DAS (50% flowering) stages is needed to achieve maximum yield and economic returns to the farmers under changing climatic conditions.

Keywords: Blackgram, PPFMB, Rhizobium, yield attributes and economics.

Climate Change and Smart Agriculture Food Production Safety Management in India an Analysis

Kalirajan, V., Sujavelu. T And V.Balamurugan

Department of Agricultural Extension, Faculty of Agriculture, Annamalai University, India.

ABSTRACT

A scope of climate smart agriculture innovations, practices and services has been started in climate-smart villages as adaptation strategies for adopting with climate risks to ensure stability and sustainability in agricultural production. The farmers utilizing CSA adaptation methodologies were found to have achieved higher yield and return compared to those individuals who not followed. There are energizing opportunities for scaling out and immense potentials of these procedures for increasing crop yields and farm incomes and diminishing ozone depleting substance discharges. Strengthening agricultural extension service and agricultural finance to accomplish smart agricultural practices/technologies by linking climate finance to traditional agricultural finance could play a significant role in scaling out the CSA practices and technologies to make agriculture more sustainable and climate-resilient and a viable source of livelihood and food security for millions of farmers in India. Zero budget natural farming (NBNF) as a climate-resilient agriculture system can upgrade food and nutritional security, enabling farmers to improve good soil fertility and yields through low costs, risk and irrigation needs, thus protecting the ecosystem by improving soil organic matter, water maintenance and biodiversity and minimizing air and water pollution as well as greenhouse gas emissions. This deals the significance of climate smart agriculture in promoting sustainable agricultural development and ensuring food security and mitigating the bad impacts of climatic changes on agricultural productivity in India.

Keywords: climate smart agriculture, zero budget natural farming, biodiversity and food security

ADOPTION LEVEL OF SUGARCANE CULTIVATION PRACTICES BY THE SMALL FARMERS IN CUDDALORE DISTRICT

Balamurugan .V, Kalirajan .V and T.Balakrishnan

Department of Agricultural Extension, Annamalai University

ABSTRACT

India, by contributing 20.4 per cent production ranks second among sugarcane growing countries of the world for both area and production of sugarcane. In this country, sugarcane is an important cash crop in the agriculture sector, which shares 7 per cent of the value of agricultural output and occupies only 2.5 per cent of the country's gross cropped area. India , resource poor type of agriculture is being practiced in majority of cases. . The adoption of technology is a complex patterns of mental and physical activities. Several personal, psychological, economic and social factors largely determine the extent and nature

3rd International Conference on “Global Initiative in Agricultural, Forestry and Applied Sciences for Food Security, Environmental Safety and Sustainable Development (GIAFAS-2021)”

of adoption and also continuance of the technology. So for this inefficiency, lack of proper and timely training for extension personnel was also attributed as one of the foremost reasons. The study was carried out in six villages from six blocks of Cuddalore District in Tamil Nadu. A total number of ten sugarcane technologies with technological units were selected for the study. The eighty respondents were selected from six villages using proportionate random sampling method. Data collection was done through a well constructed and pre-tested interview schedule. The collected data were tabulated and analyzed by using appropriate statistical tests. As the extent of adoption was also found to be low among small farmers, low cost or no cost technologies maybe developed and recommended to them. It is also suggested that the knowledge on yield contributing factors in sugarcane must be imparted.

Key Words: Small farmers, sugarcane practices

Constraints Encountered by the Mango Growers in Mango Cultivation and Marketing

V. Sakthivel,* C. Pon Alagammaiand Dr. K. Kanagasabapathi*****

Department of Agricultural Extension Faculty of Agriculture, Annamalai University, Annamalai Nagar, Chidambaram, Tamil Nadu, India

ABSTRACT

Mango is the important fruit crop which also ranks first in the area and production in India. It gives delicious taste, excellent flavour, attractive fragrance and it is also rich in vitamins A and C. These factors create a huge demand for mango in the market. Mango is native to south Asia, Indo Burma and eastern India. The vitamin-C is essential for our immune system. It also plays important role in muscle, tendon and bone growth. Eating mango improves plant iron absorption due to its vitamin C content. Mango pulp is laxative in nature and has unique nutritional value. Its wood is used for furniture making and as fuel. A study was undertaken to identify the constraints encountered by the mango growers in mango cultivation and marketing. The study was taken up at Dindigul, one of the mango predominant districts in Tamil Nadu State. A sample size of one hundred and twenty mango growers were selected based on proportionate random sampling method. Among the 4 major categories of constraints studied, marketing constraints was expressed by most of the mango growers. The order of importance of other constraints was technological constraints, economic constraints, and personal constraints.

Among the marketing constraints, the seasonal price fluctuations in market were the predominant constraint in marketing expressed by a vast majority of the respondents. Among the economic constraints, high cost of labour was the foremost economic constraint expressed by the respondents. Among the technological constraints, lack of spray fluids was the major constraint expressed by the mango growers. Among the personal constraints, lack of awareness on latest technologies was the primary constraints encountered by the mango growers in mango cultivation.

Key words: Constraints, Mango cultivation and Marketing.

Analysis on Knowledge Level of Farm Youth on Uzhavan App (Krishi App) in Thanjavur District of Tamil Nadu

M. Kavaskar¹ and R.Booma²

Department of Agricultural Extension, Annamalai University, Annamalai Nagar, Chidambaram, 608002.

ABSTRACT

Youth is a significant and crucial segment of human resources, which today as well as in future should bear the duty regarding the development including agriculture and rural segments. Farm youth are the precious asset which have an important role in developmental agricultural activities. The right thing to do at the moment is to attract and retain youth in agriculture and allied activities as this sector will be future to feed billions. Over the years, state department of agriculture has been at the fore-front in the transfer of adequate information to farmers for increased productivity. Government and private institutions developed many ICT initiatives to diffuse the farm technologies. Keeping the above points in mind a research study was taken up to access the knowledge level of farm youth on Uzhavan App in Thanjavur district of Tamil Nadu. A sample size of 120 farm youth was selected through random sampling method. A well-structured interview schedule was used for collection the data from the farm youth. Knowledge level of respondents about uzhavan app was measured by correct/incorrect dichotomy. Two score was given for ‘correct’ and one for ‘incorrect’. Total score of the individual respondent was calculated by adding the scores obtained by him on individual features. The results indicated that 48.91 as the overall mean percentage of knowledge on uzhavan application. Nearly three- fourth of the respondents (74.17 per cent) had knowledge on uzhavan application launched by the State Department of Agriculture. Unavailability of internet was the major constraint expressed by majority of the respondent (65.83 per cent).

Keywords: Farm youth, Uzhavan App, Knowledge level, State department of agriculture.

Impact of Citrus based agroforestry systems on above ground, below ground biomass and carbon sequestration.

Aarti P Deshmukh, Lalji Singh , V. M. Ilorkar and P. D. Raut

*Department of Forestry, Indira Gandhi Krishi vishwavidyalya Raipur -492 012, Chhattisgarh, India.
AICRP on Agroforestry college of agriculture, Near Maharajbagh Nagpur 440012.(M.S.)India.*

ABSTRACT

Carbon sequestration by green plant is suitable way to reduce atmospheric CO₂ in the present investigation above ground biomass and below ground biomass carbon sequestration potential of different forest species (*Tectonagrandis Eucalyptus teritocornis, Ailanthus excelsa*) under citrus based agroforestry system was measured. Total standing above ground biomass and below ground biomass of *Eucalyptus teretocornis* 49.99 and 12.99, *Ailanthus excels* 20.34 and 5.28 t ha⁻¹, and *Tectona grandis* are 10.63 and 2.76, respectively, while total standing biomass in above forest species are 13.39, 62.98 and 2.87 t ha⁻¹. The sequestered carbon stock in above ground biomass and below ground standing biomass *Eucalyptus teretocornis* 24.99 and 6.49, *Ailanthus excels* 10.17 and 2.64 and *Tectona grandis* are 5.31 and 1.38 t ha⁻¹, respectively while total carbon sequestered in above forest species are 6.69, 31.49 and 12.81 t ha⁻¹.

Keywords :- *Tectonagrandis Eucalyptus teritocornis, Ailanthus excelsa*

Partial substitution of maize mineral fertilization with some organic and bio-fertilizers

Huda M. M. Elmasry

Soils, Water and Environmental Res. Ins., ARC, Cairo University street, Giza, Egypt.

ABSTRACT

Mineral fertilizers are commonly used to improve soil fertility and plant nutrition, but the sole use of chemical fertilizers is causing deterioration in soil physico-chemical and biological properties, moreover, is toxic to animal, plants as well as for human life. Hence, it was necessary to develop alternative methods to supplying nutrients to the growing plant. Organic and bio-fertilizers are considered as a promising alternative approach for maize and other crop species production.

Two field experiments were carried out to study the effects of nitrogen application level (control, 90, and 120 kg N/fed) and five treatments (control, K- humate, vinasse, bio-fertilizer and vinasse + bio-fertilizer) on growth, yield and its components as well as chemical constituents of maize plants. The results indicated that raising mineral nitrogen fertilizer level from 90 to 120 kg N/fed. resulted in significant increases in all parameters under study. Vinasse treatment under application of nitrogen fertilizer levels had a significant effects on plant height, leaf area, protein, carbohydrates, NP- content in grain and leaves, grain k- content, yield and its components, than the treatments of K- humate, bio-fertilizer or vinasse + bio-fertilizer, in both seasons.

Through this study, it can be recommended to use vinasse with the addition of nitrogen fertilizer at a rate of 90 kg N/fed could reduced 30 kg N/fed which contributes to saving production costs by reducing the amount of chemical fertilizer addition and to minimizing the environmental pollution as well as minimize the harmful effect of nitrogen on human life.

Key words: *Bio-fertilizer, K- humate, Nitrogen fertilizer, Vinasse, Yield, Zea mays.*

Impact of Agricultural Technology Management Agency (ATMA) on production and productivity of paddy and wheat crops among different categories of farmers under Gwalior district in Madhya Pradesh

Rahul Singh Tomar, Rahul singh sikarwar , and anam khan

1,2Extension education, from RVSKVV Gwalior

3. Extension education, Navsari agriculture university navsari GJ

ABSTRACT

The present study was conducted in Gwalior district of Madhya Pradesh in the year of 2020-21. Out of four blocks (Bhitarwar, Dabra, Chinor and Gwalior) only Dabra block was purposely selected. In this block 10 villages (Masudpur, Kardu, Lakhiya, Girgheda, Rampura, Maharajpur, Chomo, Pathara, Ghamodpura and Girgheda) were randomly selected, from these villages 12 (4 small, 4 medium and 4 large) ATMA beneficiaries were selected from each village by simple random sampling method. Thus the total numbers of 120 ATMA beneficiaries were selected. The data were collected on profile, level of knowledge and impact of ATMA project on production and productivity of paddy and wheat crop. Results revealed that the majority of beneficiaries (67.50%) belonged to middle age group (36-55 year). Most of the beneficiaries (46.66%) had educated up to higher secondary level. The majority of the beneficiaries (60.00%) had medium sized family (5-10 members). In case of occupation, majority of the beneficiaries (65.83%) were doing farming only. As regards of annual income, majority of beneficiaries' (53.33%) had medium annual income (300001 to 600000). In case of social participation, maximum number of beneficiaries (71.00%) had medium social participation. Regarding information seeking behavior, the maximum beneficiaries (57.50%) had medium level of information seeking behavior. In case of scientific orientation, majority of the beneficiaries (58.33%) had medium scientific orientation. As regards to level of knowledge, majority of the beneficiaries (53.33%) had medium level of knowledge. The majority of the beneficiaries (60.83%) had medium level of

3rd International Conference on “Global Initiative in Agricultural, Forestry and Applied Sciences for Food Security, Environmental Safety and Sustainable Development (GIAFAS-2021)”

participation. In case of attitude towards ATMA, majority of the beneficiaries' (53.33%) had high level of attitude towards ATMA project.

The study indicated that both before and after category were significantly differ with respect to knowledge and participation of ATMA project. The beneficiaries had more knowledge after implementation of the project and maximum number of beneficiaries comes under medium knowledge and participation level group.

The finding regarding to production of the paddy and wheat found that the production of both the crops after implementation of the project had significant difference over the production of paddy and wheat before implementation of the project. The production of the paddy and wheat under all the categories of beneficiaries had increased after implementation of the ATMA project. The finding connection to productivity found that both category, before and after implementation of project had significant difference and productivity of the crop of all beneficiaries had significantly increased after implementation of the project.

Significant and positive relationship was found between dependent variables (impact in production and productivity of the crops) and independent variables like occupation, annual income, social participation, information seeking behavior, scientific orientation, level of knowledge, level of participation and attitude towards ATMA.

The majority of the respondents felt at the end of the project that lack of communication facility; poor contact between farmers, agriculture officers and scientist; inadequate and untimely supply of desired inputs; poor financial condition; poor education status of the farmers; lack of technical guideline; Transport problem; and lack of proper training on selected topic.

Some Important suggestions made by the beneficiaries for making the ATMA project more effective which were organize programme in right time; demonstration should be conduct on farmers field; information must be provided on proper time; regular contact should be made among farmers, agriculture officers and scientist; training should be organized regularly; and provide transportation facilities.

Phosphorus Transformation in Rock Phosphate Fertilized Soil Applied with Phosphorus Solubilizing Bacteria and Lime

Nakeertha Venu*, N. Surbala Devi, Athokpam Herojit Singh, K. Nandini Devi and N. Gopimohan Singh
Department of Soil Science and Agricultural Chemistry, Central Agricultural University, Imphal, India,

ABSTRACT

Rock phosphate (RP) is one of the cheap sources of P but it cannot be used directly as a soil amendment due to its extremely poor solubility in water (0.1%). However, the availability of Phosphorous from RP can be enhanced by applying it with lime and through the specific use of bio-inoculants. A pot experiment was conducted in the department of Soil Science and Agricultural Chemistry, College of Agriculture, Central Agricultural University, Imphal during *Pre-kharif* season of 2021 to study the release and fixation pattern of phosphorus in rock phosphate fertilized soil in the presence or absence of PSB and lime as well as their effect on phosphorus uptake and yield of green gram (var. DGGS-4). Result revealed that the release and fixation pattern of different inorganic fractions of phosphorus, its uptake and yield of green gram were significantly affected by the application of RP either singly or in combination with PSB and lime. The occurrence of different inorganic forms of P were in the order of Fe-P>RS-P>Ca-P>Al-P>Occl-P>Saloid-P. All the inorganic fractions of P (Saloid-P, Fe-P, Al-P, RS-P, Ca-P and Occl-P) showed different trend of changes during the whole crop growth stages till harvest and contributed towards

3rd International Conference on “Global Initiative in Agricultural, Forestry and Applied Sciences for Food Security, Environmental Safety and Sustainable Development (GIAFAS-2021)”

available form. Ca-P concentration increased up to harvest. Occluded-P content increased gradually up to 30th day and then decreased till harvest. Result further revealed that available-P concentration reached maximum on 30th day followed by a decline up to harvest. Irrespective of different treatment and sampling stages total-P content in soil declined gradually till harvest. All the P treatments showed higher accumulation of inorganic fractions, active P, available P, total P in soil, plant P concentration, P uptake and yield of green gram when compared to control. Comparing among the different treatments, statistically higher accumulation of P fractions (Saloid-P and Ca-P) and total P in soil; plant P concentration, dry matter yield, P uptake and yield (stover, economic and biological yield) were recorded in soil treated with T₁₀ (100% RD of P₂O₅ from RP + PSB₁ + PSB₂ + Lime (18.71t ha⁻¹) which is followed by T₉ = 100% RD of P₂O₅ from RP + PSB₂ + Lime (18.71t ha⁻¹). Transformation of applied phosphorus into different P fractions in acid soil was recorded. Combined application of PSB and lime enhanced organic P mineralization thereby increasing soil P availability, growth and yield of green gram. The PUE, Percent Yield Response, Relative Yield Uptake (%) and Agronomic efficiency were found more in the treatments applied with PSB and lime. Agronomic efficiency of rock phosphate as a P source for crop production is boosted by the solubility effect of PSB and lime application.

Key words: Rock Phosphate, Phosphorous Solubilizing Bacteria, Lime, P fractions and Yield

STUDIES ON RICE BLAST INCITED BY *Pyricularia grisea* (Cooke) Sacc. IN TELANGANA STATE

K. Aravind¹, B. Rajeswari¹, T. Kiran Babu², S.N.C.V.L. Pushpavalli³

¹Department of Plant Pathology, College of Agriculture, PJTSAU, Rajendranagar, Hyderabad 500030; ²Rice Research Centre, Agriculture Research Institute, PJTSAU, Rajendranagar, Hyderabad 500030; ³Institute of Biotechnology, College of Agriculture, PJTSAU, Rajendranagar, Hyderabad 500030.

ABSTRACT

Rice blast caused by *Pyricularia grisea* (Cooke) Sacc. became one of the most important disease-causing substantial yield losses in many rice growing areas of Telangana State. However, sometimes resistant varieties may become ineffective due to evolutionary changes in the pathogen population. Keeping in view of the importance of disease, studies were conducted on cultural, morphological, pathological and molecular variability of twelve *P. grisea* isolates collected from major rice growing areas of Telangana State. Studies on cultural characters revealed that highest mean radial mycelial growth of the fungus was recorded on OMA (81.7 mm) followed by PDA (77.8 mm) and least mean radial mycelial growth of the *P. grisea* isolates were recorded on HLEA medium (72.5 mm) with. Colony colour of twelve *P. grisea* isolates were differed from greyish white to greyish black on three solid media tested. All the isolates were found circular in form and varied with respect to mycelium elevation and texture. Significant differences were also observed among the isolates with the formation of sector, zonation and wrinkle. Among the three different liquid media tested, highest mean mycelial dry weight of the *P. grisea* isolates was recorded on PDB (225 mg) followed by OMB medium (214 mg) and least mean mycelial dry weight was recorded on HLEB medium (164 mg). Time taken for sporulation of isolates of *P. grisea* on OMA medium was 7.9 days followed by HLEA medium for 8 days and PDA medium for 8.2 days. Sporulation index of twelve isolates of *P. grisea* were varied from poor to excellent on rating scale of 1 to 4 on three solid media tested. The shape of conidia in all the isolates was pyriform and hyaline to pale olive, 2 septate and 3 celled with mean conidial size ranged from 18.9 to 28.2 µm in length and 6.1 to 9.3 µm in width among twelve isolates of *P. grisea*. Spore germination percentage was high in Pg1 isolate (91.6 %) and least in Pg6 isolate (28.3 %). In order to understand the dynamics among pathogen populations, 12 isolates of *P. grisea* collected from different geographical origin were tested on set of 25 international host differentials during rabi, 2019-20 in UBN method. Among the isolates, Nizamabad isolate was more virulent (4.2 score on 0-9 scale) and produced compatible reaction on 19 host differentials with PDI of 47.1 %. Whereas Karimnagar isolate was least virulent (2.8 score) by showing susceptible reaction on 8 host differentials with PDI of 28.2 %. Further, cluster analysis of the isolates divided into 6

3rd International Conference on “Global Initiative in Agricultural, Forestry and Applied Sciences for Food Security, Environmental Safety and Sustainable Development (GIAFAS-2021)”

pathotype groups. A total of 5 races were detected among 12 isolates. The most frequently occurred race was IA followed by IB, IC, ID and II-1. Molecular variability studies among the isolates of *P. grisea* identified a total of 19 alleles by SSR markers. The number of alleles amplified by each primer pair ranged from 2 to 3 with an average of 2.37 alleles per locus. Cluster analysis indicated the presence of four major groups among twelve isolates. This study will help in devising the strategies for monitoring the virulence change in *P. grisea* populations and suitable management practices.

Keywords: Rice blast, *P. grisea*, Host differentials, races, pathotype, SSR and molecular variability

Assessment of Workplace Hazards of Agro-Industrial Workers

Aman, A K Shrivastava* and A K Dave

Department of Farm Machinery and Power Engineering, Faculty of Agricultural Engineering, Indira Gandhi Krishi Vishwavidyalaya Raipur, Chhattisgarh.

ABSTRACT

The study presents the findings of working environmental conditions of five different agro-based industries of Chhattisgarh such as agricultural implements manufacturing industry; rice/puffed rice mill, pulses mill, sugar mill and vegetable oil mill. The temperature and relative humidity in industries do not crossed the limit defined by OSHA. The study revealed that average dust concentration (PM 2.5 $\mu\text{g}/\text{m}^3$) level in rice and pulses while sugar mills varied from 52-67 $\mu\text{g}/\text{m}^3$ which is in dangerous level as per National Ambient Air Quality Standards. Dust concentration level found satisfactory/within limit in implements manufacturing industry and vegetable oil mill. The illumination rate varied in implements manufacturing industry at cutting, welding and punching operations from 240-370 lux and at threading operation it was 420 lux. The maximum noise level (112 dB) measured at metal cutting and punching operations in manufacturing industry. It concluded that the workers were exposed to noise, improper material handling which leads unproductive time as well as accidents.

Keywords: agro-based, dust concentration, noise level, welding, material handling, hazards

Workplace and Occupational Health Studies of Sugar Cane Industry

Yamini Tekam, AK Shrivastava*, DK Rai, AK Dave

Department of Farm Machinery and Power Engineering, Faculty of Agricultural Engineering, Indira Gandhi Krishi Vishwavidyalaya Raipur, Chhattisgarh.

ABSTRACT

Sugarcane is an important cash or profit crop in the country. India is the second largest producer of sugar in the world after Brazil and is also the largest consumer. Chhattisgarh is making every possible effort to promote the agriculture-based industries in the state in a bid to improve the economic condition of the farmers. The annual yield of sugarcane across Chhattisgarh in India amounted to over 40 thousand kilograms per hectare in recent year. The present study deals with the measurement of workplace parameters like noise, vibration, illumination, air pollution and risk assessment in selected sugar industries in Kabirdham district of Chhattisgarh. Over 10,000 farmers in the region are stock-holders in this factory. About 100 agro industrial workers of five randomly selected sugar industries were selected. Workers in such industries face work-related health problems and prone to sever diseases. This paper focused on assessment of workplace and occupational health problems in the sugar industry of Kabirdham district of Chhattisgarh. It observed that sugar cane workers were exposed to high level of occupational accidents and toxicity of pesticides. The legal frameworks for their protection were often inadequate. Thus, increased risk of lung cancer, possibly mesothelioma exists due to burning foliage at the time of cane-cutting. Bagassosis was also found observed to be major reason for chronic infections which reduce their working productivity. In conclusion, improvisation of workplace and use of safety kits expected to reduce the work related disorder for betterment of working society.

3rd International Conference on “Global Initiative in Agricultural, Forestry and Applied Sciences for Food Security, Environmental Safety and Sustainable Development (GIAFAS-2021)”

Keywords: Occupational health, Sugar Industry, Industrial workers, workplace, Safety, Chhattisgarh

Standardization of protocol for genomic DNA extraction in *Fraxinus xanthoxyloides* a cold desert species grown in Western Himalayas

Akshit Kukreti^{1*}, Manisha Thapliyal², Santan Barthwal³, Neelam Kurmanchali^{4*} and Laxmi Rawat⁵

^{1,2} *Silviculture and Forest Management Division, Forest Research Institute, Dehradun, Uttarakhand, India*

³ *Division of Genetics and Tree Improvement, Forest Research Institute, Dehradun, Uttarakhand, India*

⁴ *Department of Agriculture, Doon Business School, Dehradun, Uttarakhand, India*

⁵ *Plant Pathology Division, College of Forestry, Ranichauri, Uttarakhand, India*

ABSTARCT

A top-notch genomic DNA extraction is an important imperative for a number of molecular and genome based studies. In the present study, a new and optimized protocol has been developed based upon the conventional cetyl trimethylammonium bromide (CTAB) method with further modifications for the isolation of genomic DNA from a cold desert least concern shrub/small tree Afghan ash (*Fraxinus xanthoxyloides*) containing high amount of secondary metabolites such as, phenols, alkaloids, polyphenol and polysaccharides. The modifications were made for DNA extraction involved the use of, 4% cetyltrimethyl ammonium bromide (CTAB), 4% polyvinylpyrrolidone (PVP) and 0.3% β-mercaptoethanol in the extraction buffer. The incubation period of the extraction buffer was also magnified from 45 minutes to 60 minutes at 58°C. The following modifications in the present method establish an easy and quick method for genomic DNA extraction and it will be useful for assessing the genetic diversity of *F. xanthoxyloides*. Whereas, the population structure of *Fraxinus xanthoxyloides* is poorly known, and no informative molecular markers for the species are available. *Fraxinus xanthoxyloides* stand needs to be conserved due to its narrow distribution range, prone to genetic depletion or extinction following habitat destruction. In India, the species is little known except in high Himalayan regions, where it is used mainly by the locals, graziers and the tribals for fodder and medicinal purpose.

Keywords: CTAB, *Fraxinus xanthoxyloides*, Molecular techniques, PVP, DNA

Effect of IBA and Saccharides on rooting and growth in stem cuttings of pomegranate (*Punica granatum* L.) cv. Bhagwa Pratibha

Department of Horticulture, R.C.A, MPUAT- Udaipur

ABSTRACT

The present experiment entitled “Effect of IBA and Saccharides on rooting and growth in stem cuttings of pomegranate (*Punica granatum* L.) cv. Bhagwa” was carried out during 2019-2020 at Fruit Research Station, Imalia, Department of Horticulture, College of Agriculture, J.N.K.V.V., Jabalpur (M.P.).

The present experiment was conducted to study the effect with seventeen treatment and three replications in Completely Randomized Design (CRD) under polyhouse condition on root, shoot and physiological parameters and establishment of rooted cuttings.

3rd International Conference on “Global Initiative in Agricultural, Forestry and Applied Sciences for Food Security, Environmental Safety and Sustainable Development (GIAFAS-2021)”

The study revealed that significant differences were existed among different treatments for different growth parameters. Among the seventeen treatments sucrose 5000 ppm (T₄) performed superior in shoot and physiological parameters and IBA 5000 ppm (T₁₆) performed superior in root parameters.

Of the seventeen treatments sucrose 5000 ppm recorded maximum sprouting percentage, shoot parameters *viz.*, number of shoots, number of leaves and length of new shoots and physiological parameters *viz.*, leaf area, leaf area index, leaf area duration, chlorophyll content index and light transmission ratio. IBA 5000 ppm recorded maximum number of primary and secondary roots, length of primary and secondary roots, longest root length of primary roots, success and survival percentage of rooted cutting.

From the present investigation it can be concluded that the cuttings treated with sucrose 5000 ppm and IBA 5000 ppm gave pronounced effect on shoot and root formation indicating its eliteness for propagation in pomegranate under polyhouse conditions.

PBS1 Decoy system in Plant Diseases Resistance

Mohamad Ayham SHAKOUKA

University of Aleppo

ABSTRACT

Pathogen recognition by plants is mediated by both transmembrane cell surface receptors and intracellular receptors (Jones and Dangl, 2006). The latter receptors typically belong to the nucleotide-binding leucine-rich repeat (NLR) superfamily of proteins (von Moltke et al., 2013). The immune response activated by NLR proteins is referred to as effector-triggered immunity. In the majority of examples studied, effector-triggered immunity is accompanied by localized host cell death around the site of pathogen ingress, which is referred to as the hypersensitive response. Several NLR proteins have been shown to detect pathogen effector proteins indirectly by detecting the modification of other host proteins mediated by the effectors (DeYoung and Innes, 2006). The *Arabidopsis* resistance protein RPS5 nucleotide-binding leucine-rich repeat (NLR) protein, is activated by the proteolytic cleavage of one protein kinases (PBS1), by the *Pseudomonas syringae* effector protease AvrPphB. Which targets serine-threonine kinases involved in (PAMP)-triggered immunity (Zhang et al. 2010; Shao et al. 2003). PBS1, forms a preactivation complex with RPS5 and triggers RPS5 activation upon AvrPphB dependent cleavage (Ade et al. 2007). The resulting conformational change in PBS1 activates RPS5 and then induce resistance response. RPS5 can theoretically confer resistance to any pathogen with an effector capable of causing the necessary conformational change in PBS1. PBS1 can be altered to contain cleavage sites for other proteases, enabling RPS5 activation by these proteases, thereby conferring resistance to different pathogens. This decoy approach can be translated into crop species for development of new genetic resistance against important crop pathogens.

Discussion of some common fungal post harvest diseases of garlic in Manipur
Rimamay Konjengbam^{1*}, N Sunita Devi², Takhellambam Julia³ and Kota Chakrapani⁴
College of Agriculture, Central Agricultural University, Imphal West, Manipur

ABSTARCT

Post harvest diseases of vegetable crops not only hinder crop’s productivity but also have crucial impacts on market value of the produce. Several post harvest fungal diseases have shattered marketability of the vegetable produce. Garlic is one of the economically important rabi season spice crops in Manipur. Unfortunately, it suffers from various post harvest diseases. Black mould rot caused by *Aspergillus niger*, *Rhizopus* rot caused by *Rhizopus stolonifer* and blue mold caused by *Penicillium* species are common post harvest diseases of garlic. Post harvest clove rot of garlic caused by *Sclerotium rolfsii* is another emerging post harvest disease which had been reported from some market places in Manipur. Such post harvest diseases becomes prominent only after harvest during storage and transit. In Manipur, most of the small scale farmers and vegetable sellers suffered from heavy economic losses due to post harvest diseases since they lack adequate knowledge regarding post harvest pathogens and its management. Moreover, they cannot afford provisions and machinery necessary for avoidance of such diseases. Such diseases also confer harmful effects on human health. Hence, further works is considered very essential in regards to post harvest diseases of garlic as well as other vegetables in Manipur.

Keywords: Post harvest, disease, garlic, marketability, human health.

Determination of Genetic relatedness among Common Bean Genotypes of Northern India
Nancy Gupta¹, Sajad Majeed Zargar², R. K. Salgotra¹

¹*School of Biotechnology, SKUAST Jammu, Jammu and Kashmir 180009, India*

²*Division of Plant Biotechnology, SKUAST Kashmir, Jammu and Kashmir 190025, India*

ABSTRACT

Common bean is considered as one of the most important grain legume due to immense nutritional and therapeutic value. Phenotypic evaluation among the germplasm procured from fifteen different regions of Northern India revealed a highly significant positive correlation between pods per plant and seeds per plant; days to 50% flowering and days to fruiting; days to bud initiation and days to 50% flowering and days to bud initiation and days to fruiting. Further, molecular analysis by employing SSR markers revealed two distinct sub-populations with significant heterozygosity and fixation index indicating similarity among the ancestors. The allelic frequency divergence revealed 0.0942 or 9.42% dissimilarity existing between the two sub-populations. The highest similarity between genotypes of Bandipora, Kashmir and Uganda communicated in the present study indicates that the genotypes in our study showed demarcation according to their place of cultivation. As common bean is an autogamous plant, it was expected that the observed heterozygosity (0.177) for SSR markers would be less than the expected heterozygosity (0.564) which further reveals more divergence within the population. MTAs performed in the present investigation are sure to assist marker assisted selection programme by converting significant MTAs into robust markers together with cloning and characterization of putative candidate genes and identification of lines with desirable traits for the purpose of amelioration of common bean germplasm assuring superior and sustainable genotypes with high agronomic merit in the coming years.

Keywords: Common bean, Phenotypic correlation, SSR, Genetic relatedness

Impact Analysis of Drip- Fertigation on Growth and Yield attributes of Tomato (*Lycopersicon esculentum* Mill)

K.S.Yadav*, and Dr Mamta Singh

Jawaharlal Nehru Krishi Vishwa Vidyalaya, Krishi Vigyan Kendra, Sagar (M.P.)

ABSTARCT

Tomato (*Lycopersicon esculentum* Mill) belong to family solanaceae is one of the most popular and remunerative vegetable crops and widely grown in India as well as in Sagar District of Bundelkhand region in MP also. It is a rich sources of vitamins A and C, minerals Ca, P and Fe, lycopene and beta-carotene. The efficient use of water by micro irrigation systems with poly mulching is becoming minimize the cost of input and save the labour cost which is very important in semi-arid regions with limited water resources. An application of water soluble fertilizer through drip with mulching was found better than without fertigation or indiscriminant manner of use of fertilizers. In the Bundelkhand region farmers are generally grown of tomato crop as conventional methods- furrow irrigation and some of the farmers taken on raise bed through drip irrigation system as indiscriminant use of fertilizers or without fertilizers.

Keeping of these point of views KVK, Sagar were laid down various trials as OFT on farmers field at 10 location during the two consecutive years 2017-18 and 2018-19 in Rabi season. In the present study, 25 micron silver and black coated poly mulching sheet used alongwith soluble fertilizers NPK,18:18:18 @ 190:90:90 Kg per ha after 45 days in 14 split doses at seven days intervals through drip irrigation over farmers practices. In the two years average pooled data were analyses. The result was comprised with farmer's practices with recommended practices. Total numbers of branches per plant (7.52), numbers of fruit per plant (55), weight of average fruit per plant in gm (78.60), and average height of plant in cm. (109.12) were also recorded over farmer practice 5.20, 40, 63.53 and 83.01cm, in respect of improved practice in the same hybrid variety of tomato during trials. The average yield of tomato were found 542 q/ha in the adaptive trail over farmers practice 303.50 q/ha with additional yield of 238.50 q/ha and the average increasing in productivity by 78.60%. The technology and extension gap were found 258 q and 239 q/ha, respectively, with the technology index of 32.25 % in the trails on farmers field. Besides this, gross return, cost of cultivation, net return and benefit cost ration were also calculated. On an average cultivation of tomato under improved technology gave higher net return of Rs. 381600 /ha with average net return of Rs. 171300 /ha, which was lower in farmer practices. The benefit cost ratio of tomato 4.51 in improved practices on farmers field and 2.95 under farmers practices. The productivity gain under OFT over farmers practices of tomato created greater awareness and motivated to the other farmers to adopt the balance and split doses of soluble fertilizers through drip fertigation and poly mulching in the district.

Keywords: *Tomato, Drip irrigation, Fertigation, Mulching, Nutrient distribution, NPK.*

Effect of Integrated Nutrient Management on Growth and Yield Parameters of Pomegranate (*Punica granatum* L.) cv. Super Bhagwa in Southern Rajasthan

S. Dadheech, RaviKant Sharma and C. M. Yadav*

*College of Agriculture, Bhilwara, MPUAT Udaipur *KVK, Bhilwara*

ABSTRACT

An experiment was conducted to investigate the efficacy of integrated nutrient management on growth attributes and fruit yield of pomegranate (*Punica granatum* L.) cv. Super Bhagwa under Bhilwara district during ambe bahar of 2018 at Horticulture Farm, College of Agriculture, Bhilwara. The field experiment consisting of 9 treatments viz. T₁ - 100 % RDF

3rd International Conference on “Global Initiative in Agricultural, Forestry and Applied Sciences for Food Security, Environmental Safety and Sustainable Development (GIAFAS-2021)”

through chemical fertilizers (control), T₂ - 50 % RDF through chemical fertilizers + 50 % through vermicompost, T₃ – 50 % RDF through chemical fertilizers + 50 % through neem cake, T₄ - 50 % RDF through chemical fertilizers + 50 % through FYM, T₅ - 50 % RDF through chemical fertilizers + 50 % through poultry manure. T₆ – 100 % through vermicompost, T₇ – 100 % through neem cake, T₈ – 100 % through FYM and T₉. 100 % through poultry manure replicated thrice . The biofertilizers were applied as common dose to all treatments. Significant differences were observed in all the treatments over control. The results revealed that application of 50 % RDF through chemical fertilizers + 50 % through vermicompost (T₂) has recorded the maximum fresh weight of leaf (0.32 g), dry weight of leaf (0.21 g), leaf area (10.92 cm²), shoot length (37.22 cm) at 30 days after treatments application. Maximum weight of fruit (294.63 g), number of fruits per tree (63), yield per tree (19.93 Kg), yield per hectare (18.46 t/ha) were also recorded significantly higher in treatment T₂. However the treatments T₂ was at par with treatment T₅.

Key words – Integrated nutrient management, *Punica granatum* , growth and yield.

INNOVATIVE JALKHUND AND MICROIRRIGATION IN NORTH EASTERN INDIA

Megha Raghavan and A S Mailappa*

College of Horticulture and Forestry, Central Agricultural University, Pasighat, Arunachal Pradesh

ABSTRACT

The agricultural sector (irrigation), which currently consumes over 80 percent of the available water in India, is one of the major water-consuming sectors due to the intensification followed in it. The coverage of irrigation is only about 40 percent of the gross cropped area but India has the largest irrigated area in the world. The water use efficiency under conventional flood method of irrigation is very low due to substantial conveyance and distribution losses. Recognizing the decline of irrigation water potential and increasing demand for water from different sectors, a number of demand management strategies and programmes have been introduced to save water and increase the existing water use efficiency in Indian agriculture. One such method introduced relatively recently in Indian agriculture is micro-irrigation, which includes both drip and sprinkler method of irrigation. Making of Jalkhund (farm ponds) in the field itself have the benefits of better recharge of ground water and availability of water during dry period. Micro-irrigation (MI) is proved to be an efficient method in saving water and increasing water use efficiency as compared to the conventional surface method of irrigation, where water use efficiency is only about 35-40 percent. In spite of having the largest irrigated area in the world, India too has started facing severe water scarcity in different regions. A success case of Pasighat farms are taken to consideration. Owing to various reasons the demand for water for different purposes has been continuously increasing in India, but the potential water available for future use has been declining at a faster rate. One of the main reasons for the low coverage of irrigation is the predominant use of flood (conventional) method of irrigation, where water use efficiency is very low due to various reasons. Available estimates indicate that water use efficiency under flood method of irrigation is only about 35 to 40 percent because of huge conveyance and distribution losses.

Keyword: irrigation, water, drip, sprinkler, etc.

Qualitative Dermatoglyphics Analysis In Deaf Mute Children Of Meerut

Ruhi Tomar ^{*a}, Shivani Yadav ^b, D.K Chauhan ^c, Juhi Aggrawal^d

a,b,c, Department of Zoology, Chaudhary Charan Singh University, Meerut,

d, Vardhaman College, Bijnor, Uttar Pradesh (250004)

ABSTRACT

Deaf-mute is a term that was used historically for an individual who was either deaf or mute, or both deaf and silent. In this, there is a loss of hearing before the age of two-three years which creates a problem in learning to talk. Most of such cases are the result of acute infectious diseases (measles, typhoid, encephalitis, cerebrospinal meningitis), toxic effects of any medicines, etc. There is also a possible etiology of congenital deaf-mutism.

Dermatoglyphics is a branch of science that deals with the study of the patterns of skin ridges (dermal ridges) present on the finger, palms, toes, and soles of humans (Ramani P et al., (2011). The term was given by Cummins and Midlo of Tulane University (1926). They explained dermatoglyphics and justified the application of this scene to the fields of criminology, personal identification, embryology, comparative anatomy, physical anthropology, genetics, and medicine. These may have a strong genetic relation between congenital deafness and dermatoglyphics.

The present study was undertaken to compare various qualitative dermatoglyphics pattern of deaf-mute children as cases with normal children as controls. An official performance for dermatoglyphic was prepared for both hands separately.

Qualitative dermatoglyphic patterns studied were:

- ❖ Radial loops
- ❖ Ulnar loops
- ❖ Whorls

Fingerprints were taken by ink method. The various results obtained were arranged in tabulated form and graphical form for their differentiation. Obtained numerical data from samples were analyzed statistically and tested for statistical significance.

Keywords- Dermatoglyphics, Deaf-Mutism, Radial loops, Ulnar Loops, Whorls.

***Cordyceps militaris* L.: Chemical compounds and its opportunities**

Shivangi Pandey, Suneeta Singh, Moinuddin, Shubhanshu Karasi, Ankit Semwal

School of Agricultural Sciences, Shri Guru Ram Rai University- Dehradun, (U.K.) India

ABSTRACT

Cordyceps militaris commonly known as Keedajadi a famous Chinese medicinal he *Cordyceps* rb. This was discovered several years ago with a long history of widespread use in folk medicines, and its biological and medicinal functions are well studied. This caterpillar mushroom is not only found in the higher hills but can also be cultivated in a controlled atmosphere with proper precautions and care. It is mostly used in a dried form after harvesting when matured. It increases its shelf life and makes it suitable for storage. This is the best and most suitable therapeutic herb suggested as an immunomodulator. Several chemical compounds present in it makes it a power house of immunity. Its immunomodulatory effect is because of different extracts of *Cordyceps militaris*, namely polysaccharides and cordycepin. Total extracts obtained using water or 50% ethyl alcohol and polysaccharides from *Cordyceps militaris* were discovered to tend to promote type 1 immunity, whereas total extracts obtained using 70–80% ethyl alcohol and cordycepin from *Cordyceps militaris* were more likely to promote type 2 immunity. Cordycepin is the bioactive compound which is the most common and crucial type of complementary and alternative medicine. Higher the content of cordycepin, more effective it will be in the body. It is also used as an antiaging agent and helps body to deoxidise. It has been widely used for antitumor, which has been found to exert antiangiogenic, antimetastatic and antiproliferative effect as well as inducing apoptosis. It is one of the important supplement or substitute medicine drug for cancer treatment.

Keywords: Antitumor, Antiangiogenic, Antiproliferative, Apoptosis, Cordycepin, Keedajadi, Immunomodulator

Current Scenario Bhimal Tree (*Grewia optiva* L.) as Forage in The Mountain/Hilly Areas of Uttarakhand

Ankit Semwal, Moinuddin, Suneeta Singh, Shivangi Pandey, Pankaj Nautiyal

School of Agricultural Sciences, Shri Guru Ram Rai University Dehradun (U.K) India

Krishi Vigyan Kendra- VPKAS- (ICAR) Chinyalisaur Uttarkashi, (U.K) India

ABSTARCT

In winter season mainly in the month of December to February it is difficult to complete the need of green fodder in mountain are due to the extreme cold weather conditions, even the rate of deciduous grass is also too low in this season. In this situation we can fulfil the need of green fodder with the tree *Grewia optiva* L. which is also known as Bhimal tree belongs to the Malvaceae family. It is the tree which generally can be seen in the locality of mountains area of the Uttarakhand state and can be use for the forage, wood, fuelwood purposes, generally its leaves are used for the forage for the cattle, sheep, goat, buffaloes etc, while in winter season other forage crops finds difficulties to produce, then *Grewia optiva* L. plays a major role in the green leafy fodder for the animals, Bhimal is a medium height tree which have above which canopy is small and spreader, branch of Bhimal tree are generally smooth in texture, it is flexible, and also a little soft, there are broad leaves on the Bhimal tree which are generally fallen off on the month of March to April, but new leaves are generally appears on the tree at the month of May to early June, therefore there is a very small period by when the tree is without the canopy, flowers appears at the time of appearance of leaves tooand got mature till the month of late November to December, the fruits are developed in the month of June to July and come to their full size by the month of September, ripening of fruits occurs from last of October to December month . It can also grow on the hilly or sloppy land, by which it can be grow on the maximum area which results in the more forage for animals. There is the high level of protein can befound in the new leaves of Bhimal tree but loses all its nutritive value during the rainy seasons, the level of Tenin is too low in the forage of this tree by which farmers can feed the forage to there animals without any doubts. The canopy of Bhimal tree is too high which represents about 70% of the green weight of branches.

Key words- Canopy, Deciduous, Forage, Fuelwood, Ripening, Tenin

Protected Agricultural Technology for Growing of Vegetables in High-Tech Nursery

Ankit Semwal, Moinuddin, Suneeta Singh, Shivangi Pandey, Pankaj Nautiyal

School of Agricultural Sciences, Shri Guru Ram Rai University Dehradun (U.K) India

Krishi Vigyan Kendra (ICAR-VPKAS), Chinyalisaur Uttarkashi, (U.K) India

ABSTARCT

High tech nursery is a combination of poly green house and agrinet house. Vegetative reproduction is used inn such nurseries to ensure genetic similarities with the source. High tech overcome the limitations like poor control over climatic factors, low germination percentage, longer duration, and high cost involved in conventional methods of plant raising. A nursery has an immense value in growing of vegetables crops like Solanaceae family, brassicaceae family which are highly sensitive towards temperature and moisture. This high-tech nursery helps the farmer or grower to specially those who have a very limit of land holdings, by increasing the production with good quality and with minimum wastages of production. During rainy seasons and post-rainy seasons , the condition of fields is not good for raising the virus free seedlings (mainly of Solanaceae family vegetable crops) because it consist high amount of the soil borne fugus in and high population of whitefly in the atmosphere which can reduce the production and quality of the production, hence nursery raising technology under protected condition (high-tech poly houses) has been standardized for different vegetable for raising virus free or disease free seedlings which are healthy in high tech nursery grower can raise seedlings of any plant on any on-season and off-season. This is a boon for growers and farmers to help them with their outcomes with the yield. In high-tech nursery seedlings can be raised under adverse climatic condition where it is not possible under the conditions of open fields, healthy seedlings can be raised in a short period of time as compared to the open field conditions of nursery which take too much time. There is a quick establishment of the seedling as compare to open nursery system, raising of nursery can be propagated through both sexual and asexual propagation methods, management practices of insect-pest disease is quite a easy task under protected conditions/ Greenhouse. Cultivation of different crops with different temperature required on the same land can not be grow on the open fields, but it can managed under the high-tech polyhouse with its sensors and advanced techniques. Watering the plants in proper requirement manually can be a difficult task for growers but it can managed under the conditions of high-tech polyhouse, which can prevent the seedlings from the damage of moisture an other moisture factors. Lack of nutrition

3rd International Conference on “Global Initiative in Agricultural, Forestry and Applied Sciences for Food Security, Environmental Safety and Sustainable Development (GIAFAS-2021)”

can cause the some damage or disorders in the production, which can lead to the yield loss. A well grown transplant will have adequate nutrients reserves to ensure rapid establishments under a wide variety of field conditions. Growers should the fertilizer which have contains most of the nitrogen in nitrate form, and should avoid the fertilizers that contain the high amount of urea. Grower should use the fertilizers that contain low to medium phosphate concentration because using of high concentration of phosphate may lead to the excessive seedling elongation in some conditions. Different vegetable crops response differently on the fertilizer, so it is also necessary to give an adequate amount of fertilizer to crop for their better quality and development. the concentration of the fertilizers solutions is generally expressed in parts-per-million (PPM) of nitrogen.

Key Words = Agrinet, Cultivation, Elongation, Greenhouse, Nurseries, Propagation, Seedlings.

Economic yield assessment in *Digitalis purpurea* L. under different levels of farm yard manure under high hills of Uttarakhand

Sonali Rana, Suneeta Singh and B. P. Nautiyal*

School of Agricultural Sciences, SGRR University, Dehradun- Uttarakhand (India)

**VCSG Uttarakhand University of Horticulture & Forestry, Bharsar- Uttarakhand (India)*

ABSTRACT

A field experiment was carried out to study the “Economic yield assessment in *Digitalis purpurea* L. under different levels of Farm Yard Manure under high hills of Uttarakhand” to observe seed germination behavior at various temperatures viz. 15 °C, 25 °C, 30 °C and ambient temperature. Various doses of Farm Yard Manure were applied to evaluate optimum growth and yield behavior. The experiment was laid out in a RCBD with three replications. The observations were recorded on plant height (cm) and number of leaves at regular intervals. Analysis of variance showed significance increase among various treatments. Seed germination percentage was maximum under laboratory condition (15⁰ C) whereas plant height was recorded maximum in T5 (20 tonne FYM) and T3 (10 tonne/ha) in first and second growth seasons. It can be concluded that 10 tonne FYM per ha is most effective and economical for better growth and economic yield (228.28 g ha⁻¹) in *Digitalis purpurea* as compared to other treatments.

Key words: Economic yield, Ambient temperature, Seed germination, *Digitali, purpurea*,

Effect of Phosphorus Fertilization Inorganic Phosphorus Fractions and Available Phosphorus of Soils

Tahir Ali*, Ananta G. Mahale* and Moinuddin**

Division of Soil Science & Agriculture Chemistry,

**SKUAST-Kashmir, Srinagar (J&K) Faculty of Agriculture, Wadura (Sopore)*

***School of Agricultural Sciences, Shri Guru Ram Rai University- Dehradun(U.K)India*

ABSTRACT

Phosphorus (P) is an important nutrient for Plant, animal and human development due to its key element in various physiological and biochemical processes. P mainly occurs in DNA and RNA structures that store andinterpretgenetic information and control all living processes of plants, animals and human.Phosphorus is the most important macronutrients for plant development after nitrogen but phosphorus availability is low to medium in most of the soil due to slow diffusion and high fixation in soil, which is one of the most limiting factors for plant growth.Fixation of Phosphorus in the soil, commonly found organic and inorganic forms. Generally in agricultural soils mostly present of fixed form of phosphorus than available P, a considerable part of which has accumulated as a consequence of regular application of P fertilizers. However, a large amount of soluble inorganic phosphate added to soil is quickly fixed as insoluble forms soon after application and become unavailable to plants. Fixations of P in acid soils are free oxides and hydroxides of Al and Fe, while in alkaline soils fixed by Ca. Hence Phosphorus availability in the soil to crops is very low. Increase the all phosphorus fraction in the soils by the incorporation of lantana, specially the organic (NaHCO₃-Po and NaOH-Po) P fractions due to

3rd International Conference on “Global Initiative in Agricultural, Forestry and Applied Sciences for Food Security, Environmental Safety and Sustainable Development (GIAFAS-2021)”

increased soil organic carbon. In the non-calcareous alkaline soils, the added P is mostly transformed into saloid-P and Ca-P while in acidic soils it's more towered Al-P and saloid-P. The increasing inorganic P fractions as well as available phosphorus levels in soil due to the long term manuring and fertilization that was related to total phosphorus and P input.

Keyword: Phosphorus and Fixation of Phosphorus in the Soil.

Impact of Climate Change on Agriculture

Owais Bashir, Tahir Ali, Z.A. Baba, Moinuddin* and Mohammad Nowmaan**

Division of Soil Science & Agriculture Chemistry,

SKUAST-Kashmir, Srinagar (J&K) Faculty of Agriculture, Wadura (Sopore)

** Shri Guru Ram Rai University- Dehradun (U.K) India and **GBPUA & T, Pantnagar*

ABSTARCT

Climate change is a significant and lasting change in the statistical distribution of weather patterns over periods ranging from decades to millions of years. It may be a change in average weather conditions or the distribution of events around that average (e.g., more or fewer extreme weather events). Climate change means a change of climate which is attributed directly or indirectly to human activity that alters the composition of the global atmosphere and which is in addition to natural climate variability observed over comparable time periods. Despite technological advances, such as improved varieties, genetically modified organisms, and irrigation systems, weather is still a key factor in agricultural productivity, as well as soil properties and natural communities. The effect of climate on agriculture is related to variability's in local climates rather than in global climate patterns. The Earth's average surface temperature has increased by 1 °F (-17 °C) in just over the last century. The Intergovernmental Panel on Climate Change (IPCC) has produced several reports that have assessed the scientific literature on climate change. The IPCC Third Assessment Report, published in 2001, concluded that the poorest countries would be hardest hit, with reductions in crop yields in most tropical and sub-tropical regions due to decreased water availability, and new or changed insect pest incidence. In Africa and Latin America many rainfed crops are near their maximum temperature tolerance, so that yields are likely to fall sharply for even small climate changes; falls in agricultural productivity of up to 30% over the 21st century are projected. Marine life and the fishing industry will also be severely affected in some places. Climate change induced by increasing greenhouse gases is likely to affect crops differently from region to region. For example, average crop yield is expected to drop down to 50% in Pakistan according to the UKMO scenario whereas corn production in Europe is expected to grow up to 25% in optimum hydrologic conditions. In the long run, the climatic change could affect agriculture in several ways likewise *productivity, agricultural practices, environmental effects, rural space and adaptation*. Most agronomists believe that agricultural production will be mostly affected by the severity and pace of climate change, not so much by gradual trends in climate. If change is gradual, there may be enough time for biota adjustment. Rapid climate change, however, could harm agriculture in many countries, especially those that are already suffering from rather poor soil and climate conditions, because there is less time for optimum natural selection and adaption.

Key word: Agriculture Climate, green House gas, weather,

Thematic Strategy and Indicators for Soil Protection

Owais Bashir, Tahir Ali, Z.A. Baba, Moinuddin* and Mohammad Nowman**

Division of Soil Science & Agriculture Chemistry,

SKUAST-Kashmir, Srinagar (J&K) Faculty of Agriculture, Wadura (Sopore)

** Shri Guru Ram Rai University- Dehradun (U.K) India And **GBPUAT, Pantnagar*

ABSTARCT

Indicators are becoming progressively critical tools for assessing threats to the soils, caused by soil organic matter decline, soil sealing, soil erosion, contamination, salinization and loss of biodiversity. According to the European Environmental Agency an indicator is a character, generally quantitative, that defines and analyses complex phenomena simply, including trends and progress over time. Practically, the implementation of an indicator system for soil monitoring necessitates a limited number of easily available and quantitatively measurable indicators in order to avoid ineffectiveness of using the system by various stakeholders. Several European and Asian research projects have been proposed for determining critical indicators for assessing the effectiveness of the various land management practices and technologies for monitoring soils and combating land degradation. These researchers have proposed several indicators for each of the land degradation threats. The primary criteria of indicator selection included significance to the issue, existence of necessary measurement procedures, policy relevance, and geographical coverage. Some of them, easily evaluated, could substitute a number of others. Some of the indicators could be estimated from others by using pedotransfer functions. Furthermore, when crucial indicators, such as soil depth, water scarcity, reach or exceed critical thresholds values, land is leading to severe degradation, regardless of other favorable state and influx indicators. The effects of the influx's indicators (such as rainfall, fires, land management) on the state indicators (soil depth, slope gradient, rock fragments) are usually complex and interdependent. They may also have opposite effects depending on the state indicators (e.g. land abandonment, land terracing). This makes the accurate scaling and the weighing of the indicators difficult. Scaling the indicators on experience, observations, and educated guessing could be useful tool for some practical applications and for comparative evaluations. They should, however, be checked against real situations in the field. Based on the existing research results, even though more research work is needed, indicators may be widely, even globally, used for assessing the various soil degradation processes or causes or threats at field level. Processes of soil degradation cannot be easily simplified. A reasonable number of indicators is necessary to assess the impact of the various threats on soils and more generally on ecosystems. Indicators must be considered as valuable tools for understanding and managing complex systems, especially at stakeholder or decision making level.

Keyword: Thematic Strategy, Indicators, Soil Protection

Soil protection and its Strategies – how to bridge between science and decision making

Owais Bashir, Tahir Ali, Z.A. Baba, Moinuddin* and Mohammad Nowman**

Division of Soil Science & Agriculture Chemistry,

SKUAST-Kashmir, Srinagar (J&K) Faculty of Agriculture, Wadura (Sopore)

** Shri Guru Ram Rai University- Dehradun (U.K) India and **GBPUAT, Pantnagar*

ABSTRACT

Soil degradation is escalating worldwide and therefore the question arises: Is something wrong with our strategies for soil protection? Even taking into consideration that the tasks of science and technology on one side and politics and decision making on the other side are very different and admitting that science can only develop proposals based on scenarios, in

3rd International Conference on “Global Initiative in Agricultural, Forestry and Applied Sciences for Food Security, Environmental Safety and Sustainable Development (GIAFAS-2021)”

order to convince politicians to take decisions and to protect soils, we need urgently to analyze our actual concepts for soil protection. Soil degradation is a complex issue, deriving from social, economic, technical, environmental and cultural impacts, which altogether have to be considered in order to come to a conclusive concept or a strategy for soil protection. Regarding soil protection, politicians and decision makers must be informed in detail about the complexity of the processes and especially about the economic and social impacts of soil degradation, because this is targeting their political positions, by whom they are elected and appointed. It seems therefore necessary to use an approach which considers all the different aspects of soil degradation. One of these approaches is the DPSIR-framework approach, which looks into the Driving forces, the Pressures arising from those, the State of degradation which they cause, as well as the environmental, technical, social and economic Impacts, thus allowing for formulating Responses through politics and decision making. In the following, a concept is described, which helps science to develop sound scenarios for soil protection on this basis. The approach involves five main steps, which aim at the following targets: 1. To know the processes in the environmental system, leading to soil degradation; 2. To know where these processes occur and how they develop with time (monitoring); 3. To understand the relationship between those processes and existing land use policies as well as land use management systems; 4. to analyze and understand the impacts of soil degradation on further environmental compartments such as air, water, biomass production, as well as on the social and economic wellbeing of human societies and on human health; and finally, on the basis of 1-4, 5. To develop clear targets for combating soil degradation processes based on arguments which are important and easily understandable for politicians and decision makers. In view of the complexity of the subject, political, social, economic, technical and further sciences will be needed to elaborate scenarios and proposals for politics and decision making.

Key Word: Soil protection, Degradation, Bio mass production,

Current Scenario and Issues of Organic Farming in India

Owais Bashir, Tahir Ali, Z.A. Baba, Moinuddin* and Mohammad Nowmaan**

Division of Soil Science & Agriculture Chemistry,

SKUAST-Kashmir, Srinagar (J&K) Faculty of Agriculture, Wadura (Sopore)

** Shri Guru Ram Rai University- Dehradun (U.K) India and **GBPUA & T, Pantnagar*

ABSTRACT

Organic farming in India is not new and is being followed from ancient time. It is a method of farming system aimed cultivating the land and raising crops in such a way, as to keep the soil alive and in good health by use of organic wastes and other biological materials along with beneficial microbes (Biofertilizers) to release nutrients sustainable production in eco-friendly pollution-free environment. India holds a unique position among 172 countries practicing organic agriculture: it has 6,50,000 organic producers, 699 processors, 669 exporters and 7,20,000 hectares under cultivation. But, merely 0.4 percent of total agricultural land under organic cultivation, the industry has a long journey ahead (Bordolo, 2016). India produced around 1.35 million MT (2015-16) of certified organic products which includes all varieties of food products viz. sugarcane, oil seeds, cereals and millets, cotton, pulses, medicinal plants, tea, fruits, spices, vegetables, coffee etc. With increase in population, our compulsion would be not only to stabilize agricultural production in sustainable manner. The scientists have realized that the ‘Green Revolution’ with high input use has reached a plateau and is now sustained with diminishing return of falling dividends. Thus, a natural balance needs to be maintained at all cost for existence of life and

3rd International Conference on “Global Initiative in Agricultural, Forestry and Applied Sciences for Food Security, Environmental Safety and Sustainable Development (GIAFAS-2021)”

property. The obvious choice would be more relevant in the present era, when these agrochemicals which are produced from fossil fuel and are not renewable and are diminishing in availability. There is neither subsidy for organic cultivators nor incentives to practice organic cultivation. There are many areas in India where farmers use crop residues, manures, legumes and neem to grow their crops. Now it is the high time to make attempts to classify these practices accordingly. If this is done, the poor farmers will get a premium price for their low yields. This will also go a long way in alleviating poverty and raising the living standards of the poor villagers. Most of the agriculture in backward and tribal areas especially in the hills of northern, eastern and northeastern region could be safely classified as organic. We must take advantage of this opportunity by arranging a market for these products for domestic and export market.

Key Word: Organic Farming, yield, microbes

Flax fibre and blended yarn characteristics

Iramma V. Goudar and Dr. Sadhana D. Kulloli*

Department of Textile and Apparel Designing, College of Community Science, University of Agricultural Sciences, Dharwad

ABSTRACT

Stalks of flax varieties collected from AICRP, MULLARP Scheme, University of Agricultural Sciences, Dharwad were retted in water, chemical and enzymatic retting methods for extraction of fibre. The extracted fibres were assessed for quantitative and qualitative parameters viz., fibre yield, fibre length, microscopic appearance and fibre solubility in different chemicals. The extracted fibre was scoured and bleached and blended with cotton in three proportions viz., 40:60, 30:70 and 20:80 on ring frame to obtain blended yarns with cent percent flax and cotton for comparison. The blended yarns were assessed for yarn count, twist, yarn evenness, hairiness percentage and yarn strength. The results of the study revealed that, urea retting method yielded higher percentage of fibres, enzyme retted fibres gave longer length of the fibre, whereas water retted fibre yielded higher strength fibre. The 30:70 and 20:80 flax /cotton blended yarn showed better yarn properties viz., yarn count, twist, yarn evenness, hairiness percentage and yarn strength compared to 40:60 flax /cotton blended yarn. Cent percent cotton and flax yarn showed better strength and lowest hairiness percentage compared to blended yarns.

EXTRA FLORAL NECTARIES: THEIR STRUCTURE AND DISTRIBUTION

SONU KUMARI

Department of Entomology, Chaudhary Charan Singh Haryana Agricultural University, Hisar

ABSTRACT

Extrafloral nectaries (EFNs) are plant glands that secrete sugar, water and amino-acids etc. These nectar-secreting organs may be located on any above-ground plant part, the sepals (Clerodendron plant), on the shoot, leaf petiole (Rose), leaf (fern) or stipules, (cowpea) Pedicel (*Senna* spp). Extrafloral nectaries may have a role in plant protection, through the attraction of insects that guard the plant from phytophagous insects and sometimes from neighboring plants (Janzen, 1966). But in the absence of defending insect EFN protect the plant through mechanical defence. EFN of *Vicia faba*, exhibit high levels of L-3,4-dihydroxyphenylalanine (L-DOPA), a non-protein amino acid toxic to insect. The stiffness of the extrafloral nectaries of *V. faba* plant may be caused by the thickened and lignified walls of some of the cells. The main ingredients in nectar are sugars in varying proportions of sucrose, glucose, and fructose. Carbohydrates, amino acids, and volatiles function to attract some species, whereas alkaloids and polyphenols appear to provide a protective function. In one instance, Honey bees were observed feeding on the extrafloral nectar of sunflower in the afternoon when floral nectar was in short supply. They include structures that range from single-cell nectar-secreting hairs, ‘formless’ glandular tissue, complex raised cups and shallow bowl-like depressions, and they range from highly vascularized to completely lacking vascularization. EFN-bearing plants occur in tropical and subtropical regions as well as in many temperate regions

Genetic assessment of newly developed maize inbreds for yield and its attributes in different agro-climatic conditions

***Gaurav Sharma¹, Uttam Chandel², Sawan Kumar¹ and Satish Kumar Guleria³**

¹*Department of Genetics and Plant Breeding, CSK Himachal Pradesh Agricultural University, Palampur, Himachal Pradesh, India*

²*CSKHPKV, SAREC, Kangra, Himachal Pradesh, India*

³*CSKHPKV, HAREC, Bajaura, Himachal Pradesh, India*

ABSTRACT

Maize is a strategically important crop for the millions of resource-poor farmers because of its multiple uses as food, feed and raw material for industry. The detailed genetic assessment of germplasm derived new elite lines is pre-requisite for future breeding programmes. The present study was undertaken to determine the combining ability of newly derived maize inbred lines over the environments. Twenty eight crosses developed by crossing eight inbred lines in half diallel mating design, were evaluated in RBD at two environments representing different agro-climatic and ecological conditions of North-Western Himalayas (SAREC, Kangra and HAREC, Bajaura). Data was recorded for various agro-morphological traits during *Kharif*, 2019. Analysis of variance indicated sufficient amount of genetic variability in material. Bartlett's test revealed that error variance was homogeneous only for six traits out of total twelve traits. Estimates of σ^2 SCA were higher as compared to σ^2 GCA in both the environments and in pooled over environment as well, except for the days to 75% brown husk in Kangra which indicated preponderance of non-additive gene action. The inbred line B-73 in Bajaura, pooled over environment and LM-14 in Kangra were found good general combiner for most of the traits. The crosses B-73 × BAJIM-1811 and BAJIM-1522 × BAJIM-1811 in Kangra, Bajaura as well as in pooled over environment identified as the potential hybrids. The inbred lines with good GCA may be utilized as potential parents for development of high yielding single cross maize hybrids. The crosses identified as potential hybrids may be commercially exploited after critical evaluation for its superiority in performance and with stability across the locations over years.

Key words: General combining ability, genetic variance, maize, specific combining ability

Abiotic stress and its management

Harpreet Singh¹, Om Prakash Yadav²

¹*Department of Plant Breeding and Genetics, Punjab Agricultural University, Ludhiana, India*

²*Department of Genetics and Plant Breeding, CCS Haryana Agricultural University, Hisar, India*

ABSTRACT

Crop yield is mainly affected by climatic factors, agronomic factors, pests and nutrient availability in the soil. Stress is any adverse environmental condition that affects growth of plant. Abiotic stress causes severe effect on multiple procedures of morphology, biochemistry and physiology that are correlated with growth and yield of plant. Major abiotic factors include drought, flooding, high temperature and salinity. Drought can be defined as an extended period of deficient rainfall relative to the statistical mean for a region. Drought Stress can be managed by foliar spray of 2% DAP + 1% KCl during crucial stages of flowering and grain formation and 3% kaoline spray at critical stages of moisture stress. Flooding may be defined as any situation of excess water. Flooding can be managed by adequate drainage for draining excessive stagnating water around the root system, spray of growth retardant of 500 ppm cycocel for arresting apical dominance and thereby promoting growth, foliar spray of 100 ppm salicylic acid for increasing stem reserve utilization under high moisture stress. Salinity is defined as the presence of excessive amounts of soluble salts that affect the normal functions of plant growth. It can be managed by seed hardening with NaCl, application of gypsum @ 50% Gypsum Requirement (GR), foliar spray of 0.5 ppm brassinolode for increasing photosynthetic activity, Heat Stress is caused by temperature more than threshold that can be tolerated by plant i.e. mostly more than 40 °C. High temperature can be managed by cultivating plant under shade condition, overhead irrigation to avoid sunburn, application of gibberellic acid stimulate the α – Amylase, production for seed germination, lipid peroxidation and salicylic acid enhances the thermo tolerance capacity.

Structure and Pattern of Labour Utilization in Crop Activities in Sub Humid and Humid Southern Plain Region of Rajasthan

Arjun Singh Rajput^{1*}, Vikalp Sharma², P. S. Sekhawat³ and Latika Sharma⁴

^{1,2&4}Department of Agricultural Economics and Management, Rajasthan College of Agriculture, Maharana Pratap University of Agriculture and Technology, Udaipur, Rajasthan

³SKN collage of agriculture, SKNAU, Jobner, Jaipur, Rajasthan

ABSTRACT

The present investigation was undertaken with a view to estimate the structure and pattern of labour utilization in different crop activities in sub-humid and humid southern plain region of Rajasthan. The study was conducted based on primary as well as secondary data. The primary data were collected from 200 households of 10 villages during 2018-2019 and secondary data were used from census 2011. To study the labour absorption in different crop activities in principal crops the model suggested by Singh, 1996 was used. In sub-humid and humid southern plain region (Region-IV), the results showed that the share of total family labour was found maximum on marginal farms i.e. 95.56 per cent and minimum was found on large farms i.e. 59.69 per cent while the share of total hired labour was found maximum on large farms i.e. 40.31 per cent and minimum was on marginal farms i.e. 4.44 per cent in all crops and crop activities. In gender wise structure, the share of total male and female labour (both family and hired) absorption was 43.46 per cent and 56.54 per cent, 38.76 per cent and 61.24 per cent, 39.22 per cent and 60.78 per cent, 29.82 per cent and 70.18 per cent, 24.12 per cent and 75.88 per cent on marginal, small, semi-medium, medium and large farms, respectively in all crop activities. In this region, the participation of female labour was found more than the male labour on all farm size.

Key words: Labour absorption, agro-climatic regions, labour structure, pattern, crop activities

Minimum data set to improve seed and fodder yield in Oat

Priyanka*, V.K. Sood, Sawan Kumar, Amit Rana and Sanjay Kumar Sanadya

Department of Genetics and Plant Breeding, CSK Himachal Pradesh Agricultural University, Palampur-176062, India

ABSTRACT

Minimum data set (MDS) helps in identifying the most relevant characters using multivariate approach that can be used as descriptors by explaining as much of total variation in the original set of variables as possible with a few components as possible and reducing the dimension of the problem. The present investigation was effectuated to analyze diversity in oat genotypes *via* Principal Component Analysis. Two experiments were conducted on same genotypes in order to study the effect of fodder cut (70 days after sowing) to compare the dual purpose and seed yield purpose traits. A total of 76.82%, 80.29% variation explained by the first five principal components in dual purpose traits and variation seed yield purpose systems, respectively. Among dual purpose traits, leaf stem ratio resulted in highest positive value followed by tillers per plant, dry matter percent, β -glucan content and dry matter yield in all the principal components. While, among seed yield related traits, in all principal components, seed yield resulted in highest positive value followed by harvest index, crude protein content, tillers per plant and 100 seed weight. Overall leaf stem ratio followed by tillers per plant, dry matter percent, β -glucan content and dry matter yield result positive value in higher extent. These traits observed as maximum contributors towards genetic divergence. Hence, the selection on the basis of these traits would be effective for improvement of fodder yield in oat.

Key words: Diversity, fodder, oat, principal component analysis

Genetic variability and association studies of marketable traits in gladiolus (*Gladiolus hybridus* Hort.) in Bundelkhand Conditions

Rakesh Kumar^{1*}, Ajay Kumar Singh², Krishna Singh Tomar³ and Amit Kanawjia⁴

Department of Floriculture and Landscape Architecture, Banda University of Agriculture and Technology, Banda 210001, India

ABSTRACT

An experiment was carried out with fourteen varieties of gladiolus planted in RBD with three replications at Instructional Farm, College of Horticulture, Banda University of Agriculture and Technology, Banda during 2017-18 and 2018-19. The experiment was undertaken to study genetic variability, trait association through correlation and path analysis in Bundelkhand conditions of Uttar Pradesh. ANOVA revealed significant differences for all morphological characters, indicating considerable amount of variability among the genotypes. Spike length ranged from 65.07cm to 110.65cm and floret size ranged from 8.27cm to 9.66cm. Mean value for days taken to flowering, floret size and vase life was recorded 109.38 days, 8.95 cm and 8.95 days, respectively. Moderate values for PCV and GCV were exhibited by rachis length (19.97 and 15.90), spike length (18.49 and 14.40) and number of florets per spike (14.88 and 12.05). Heritability value was found maximum in days taken to flowering (68.22) and minimum in size of floret (35.63). Plant height, spike length, rachis length, duration of flowering and number of florets per spike were positively and significantly correlated with days taken to flower initiation and days taken to flowering. Path coefficient analysis revealed that spike length (1.162) exerted maximum positive direct effect on plant height followed by days taken to spike initiation (0.881) and duration of flowering (0.392).

Key words: Gladiolus, Variability, Correlation, Spike, Rachis, Corm.

Impact of Front Line Demonstration of Zinc Sulphate in yield of rice (*Oryza Sativa* L.) under the zinc-deficient area of hills

Shikha^{1*}, A.G.Yewale², Arunima Paliwal³, Ajay Kumar⁴

^{1,2} Krishi Vigyan Kendra, Ranichauri, VCSG Uttarakhand University of Horticulture and Forestry, Tehri Garhwal, Uttarakhand, India.

^{3,4} Department of Agronomy, College of Forestry, V.C.S.G. Uttarakhand University of Horticulture and Forestry, Ranichauri, Tehri Garhwal, Uttarakhand, India.

ABSTRACT

A Front line demonstration was conducted to evaluate the effect of zinc sulphate in the yield of rice (*Oryza sativa* L.) var-VL-85 under the zinc-deficient area of hills of Uttarakhand during Kharif season of 2017 and 2018 from the village of Nala and Koldhar respectively by KVK, Tehri Garhwal. So the impact of zinc sulphate in rice crops under zinc-deficient areas along with the traditional method in the farmer's field was studied. The result revealed that the yield of the rice with a traditional method with zinc sulphate @ 25 kg ha⁻¹ was 32.50 q ha⁻¹ and 35.80 q ha⁻¹ during 2017 and 2018 respectively and the yield with the traditional method (farmers practice) was 25.40 q ha⁻¹ and 27.50 q ha⁻¹ during 2017 and 2018 respectively. The yield was increased by 27.95 % and 30.18 % during 2017 and 2018 respectively. So, the yield was increased with the use of zinc sulphate. Similarly the Benefit: Cost ratio with the use of zinc sulphate was 1.53 as compared to 1.22 with the traditional method (farmers practice) during 2017 and 1.50 with the use of zinc sulphate as compared to 1.23 with the traditional method (farmers practice) during 2018. Thus the demonstration of zinc sulphate in rice crops was found better in increasing the production of rice under zinc-deficient areas.

Keyword: Front Line Demonstration, Zinc Sulphate, Traditional method

Impact of Front Line Demonstration of Zinc Sulphate in yield of rice (*Oryza Sativa* L.) under the zinc-deficient area of hills

Shikha^{1*}, A.G.Yewale², Arunima Paliwal³, Ajay Kumar⁴

Department of Genetics & Plant Breeding, Agricultural College, Bapatla, Andhra Pradesh, India

ABSTRACT

Genetic analysis and gene interactions are studied for grain yield and its component traits using parental (P₁ and P₂), F₁, BC₁ and BC₂ generations in four crosses namely MTU 1010/MTU 1140, MTU 1156/MTU 1140, SM 10/MTU 1140 and SM

3rd International Conference on “Global Initiative in Agricultural, Forestry and Applied Sciences for Food Security, Environmental Safety and Sustainable Development (GIAFAS-2021)”

14/MTU 1140 . Scaling tests performed to know the adequacy of simple additive-dominance revealed that the scales A, B and C were significant for total number of grains per panicle in all the four crosses studied. However, the other traits like days to 50% flowering, plant height, spikelet fertility and grain yield per plant exhibited significance of either one of the scales or in combination representing the existence of epistatical interactions. Dominance gene effect (h) and the interaction effect dominance x dominance (l) was pre-dominant for grain yield and majority of the yield traits studied, in most of the crosses indicating the need for employing population improvement through recurrent selection.

Keywords: Generations, gene action, epistasis, scaling tests, rice

Climate change and its impact on Indian Agriculture

Asif. M. Rather^{1*}, S. Narayan¹, T. A. Bhat¹, K. Hussain¹, M. Tariq², Ummar Atta², Nawaz A. Ganaie¹, M. A. Hajam³, A. A. Malik¹, Anil Kumar¹, M. A. Wani⁴, S. A. Mir⁵

¹*Division of Vegetable Science, SKUAST-K.*

²*Faculty of Forestry, SKUAST-K.*

³*Division of Fruit Science, SKUAST-K.*

⁴*Division of Floriculture and Landscape Architecture, SKUAST-K.*

⁵*Division of Environmental Science, SKUAST-K.*

ABSTRACT

Climate change refers to changes beyond the average atmospheric condition that are caused both by natural factors such as the orbit of earth's revolution, volcanic activities and crustal movements and by artificial factors such as the increase in the concentration of greenhouse gases and aerosol. Agriculture is a major source of GHGs (Greenhouse Gases) which contribute to the greenhouse effect and climate change. However, the changing climate is having far reaching impacts on agricultural production, which are likely to challenge food security in the future. Agriculture is an important sector of the Indian economy. Agriculture sector contributes 20.19% to the country's GDP (Gross Domestic Product). Agriculture is extremely vulnerable to climate change. Climate change and agriculture are interrelated processes, both of which take place on a global scale. Climate change affects farming in a number of ways, including through changes in average temperatures, rainfall, and climate extremes (e.g. heat waves), changes in pests and diseases, changes in atmospheric carbon dioxide and ground-level ozone concentrations, changes in the nutritional quality of some foods and changes in sea level. Changes in temperature, atmospheric carbon dioxide (CO₂), and the frequency and intensity of extreme weather could have significant impacts on crop yields. For any particular crop, the effect of increased temperature will depend on the crop's optimal temperature for growth and reproduction. If the temperature exceeds a crop's optimal level, yield increases may be reduced or reversed, while encouraging weed and pest proliferation. Pests management become less effective, meaning that higher rates of pesticides will be necessary to achieve the same levels of control. Higher CO₂ levels can affect crop yields. Elevated CO₂ has been associated with reduced protein and nitrogen content, resulting in a loss of quality. Heavy rains that often result in flooding can also be detrimental to crops and to soil structure. The overall impacts of climate change on farming are expected to be negative, threatening global food security.

Keywords: Climate change Greenhouse Gases, Gross Domestic Product, Ozone, Food Security

Response of Liquid Biofertilizer, Plant Geometry and Different Levels of Phosphorus on Growth and Yield of Green Gram (*Vigna radiata* L.)

Schhida Nand Singh, Vikram Singh, Moinuddin*, Manoj Shukla and Sharad Pandey****

Himgiri Zee University Dehradun, (U.K.) India

SHUATS- Naini, Prayagraj (Uttar Pradesh) India.

**Shri Guru Ram Rai University- Dehradun, (U.K.) India*

***MCAT - Dehradun, (U.K.) India & ***Himgiri Zee University- (U.K.)*

ABSTRACT

A field experiment was conducted during *zaid* season of 2016 and 2017 at crop research farm in Department of Agronomy SHUATS, Prayagraj. To study the response of liquid biofertilizer, plant geometry and different levels of phosphorus on

3rd International Conference on “Global Initiative in Agricultural, Forestry and Applied Sciences for Food Security, Environmental Safety and Sustainable Development (GIAFAS-2021)”

growth and yield of green gram (*Vigna radiata* L.). Total 24 treatment combination comprising of 4 levels of bio-fertilizer viz B₁ -Untreated , B₂ – Rhizobium, B₃ – Phosphate solubilizing bacteria and B₄ – (Rhizobium + Phosphate solubilizing bacteria), two levels of spacing viz S₁–30 cm × 15 cm and S₂– 45 cm × 15 cm, three levels of phosphorous viz, P₁ – 40 kg P₂O₅ / ha, 60 kg P₂O₅ / ha and 80 kg P₂O₅ / ha. The experiment was laid out in RBD (factorial) with three replications. The basic information on physic-chemical properties of soil indicated that the soil of the experimental field was sandy loam which was low in organic carbon, nitrogen and phosphorous and medium in potassium. The treatment combination of *Rhizobium* + Phosphate solubilizing bacteria, 30 cm × 15 cm and 60 kg P₂O₅ / ha recorded plant height (72.53 cm), maximum plant dry matter accumulation (15.93 g), number of branches per plant (8.77), number of nodules per plant(15.30), maximum leaf area (160.36 cm²), leaf area index (0.35) and chlorophyll content (41.67) in pre harvest observation. It was also observed that in post harvest observation, number of pods / plant (38.59), pod length / pod (10.48 cm), number of grains / pod (10.48), grain yield (15.12 q /ha) and stover yield (27.24 q / ha) was recorded maximum in the treatment combination of *Rhizobium* + Phosphate solubilizing bacteria, 30 cm × 15 cm and 60 kg P₂O₅ / ha. However, the test weight (33.84 g), harvest index (40.22) and protein content (22.32 %) were found to be non significant. On the basis of economics of different treatment combination the maximum B:C (1.66) ratio was recorded under treatment *Rhizobium* + Phosphate solubilizing bacteria, 30 cm × 15 cm and 60 kg P₂O₅ / ha.

Key words: *Rhizobium*, PSB, spacing, Phosphorous and green gram

FISH LEATHER: A VALUABLE RESOURCE FOR TEXTILE AND FASHION INDUSTRY

Shalini Rukhaya¹, Mona Verma² and Saroj S. Jeet Singh³

Department of Textile and Apparel Designing, CCS Haryana Agricultural University, Hisar-125 004, India

ABSTRACT

Eco-friendly fish leather is exotic and innovative leather made from fish skins that are discarded by seafood industries and turned into a useful material for textile and fashion industries. Fish skins are gaining interest among tanners as an additional source of quality raw material due to their attractive, beautiful and unique grain structure with three-dimensional pattern which are formed by the pockets of the scales, possessing high market value due to their increasing demand for end-use products. The tanning process completely removes all odors and transforms the waste into treasure because of the resistance achieved on its surface, found on skin of fish due to the scales. Fish leather is composed largely of a system of collagen fibers that form alternating layers of right and left helices wrapped about the long axis of the animal. There are many fish species which are available such as sturgeon, Nile perch, tilapia, salmon, carp, and stingray each having a unique appearance. Fish leather is cost effective, *durable, supple*, flexible and has affinity with most dyestuff, natural or synthetic. Physical properties which makes fish leather a unique and valuable material are high tensile strength, resistance to tear, flexing, puncture, fire, fungi *etc.* Fish leather is a versatile material that can be used for anything from handbags, belts, clothing, small accessories and shoes, to furniture and interior decoration. It is derived from waste product, thus it is cost saving natural resource avoiding extra emissions/pollution and have no issues with post use disposal because it degrades back to nature. It is also considered as an ecological and sustainable alternative to other types of leather to be used for product development.

Keywords: Fish leather, sustainable, tanning, textiles, fashion

Triacontanol induced counteractive mechanisms against salt toxicity in Indian mustard

Shaistul Islam and Firoz Mohammad*

Plant Physiology and Biochemistry Section, Department of Botany, Aligarh Muslim University, Aligarh-202002, India

ABSTRACT

Salt stress is one of the common environmental threats to growth and development of crop plants. It adversely affects plant metabolic activities and redox homeostasis that eventually lead to reduction in plant growth and development. Triacontanol (Tria) being an endogenous growth regulator actively involves in the stress management. Keeping its importance in stress management, a factorial randomized pot experiment was conducted to evaluate the effect of Tria (5 μ M) on morpho-physiological, biochemical, histochemical and ultra structural changes in Indian mustard under 0, 50, 100 or 150 mM NaCl levels. Increase in salt stress, dramatically declined root fresh and dry weight, shoot fresh and dry weight, relative water and chlorophyll content, stomatal conductance (g_s) and net photosynthetic rate (P_N), while increased malondialdehyde (MDA), hydrogen peroxide (H_2O_2) and superoxide anion ($O_2^{\cdot-}$) contents and osmolytes accumulation in Indian mustard. However, the application of Tria mitigated the adverse effects of salt stress on Indian mustard by increasing its root fresh and dry weight, shoot fresh and dry weight, Chl content, P_N and g_s . Moreover, Tria effectively eliminated the osmotic and oxidative stress by increasing its leaf RWC, osmolytes accumulation and activities of CAT, POX and SOD, while decreasing MDA, H_2O_2 and $O_2^{\cdot-}$ content. Furthermore, treatment of Tria under stress and stress free conditions improved the histochemical and microscopical parameters. Therefore, we can conclude that Tria application induces tolerance to salt stress in Indian mustard by the way of increasing synchronizingly leaf RWC, osmolyte accumulation and antioxidant enzyme activities.

Keywords: Indian mustard; Photosynthesis; Antioxidant enzymes; Osmolytes; Salt stress; Triacontanol

BIO-BASED FAUX LEATHER: ANIMAL AND ECO-FRIENDLY ALTERNATIVE

Diksha Bisht¹, Mona Verma² and Dr. Saroj S. Jeet Singh³

Department of Textile and Apparel Designing, CCS Haryana Agricultural University, Hisar- 125004, India

ABSTRACT

Traditional leather that is also known as real leather is manufactured by chemical processing of animal skin. The use of leather in clothing and accessories leads to suffering and torture of animals. Moreover, tanning or other treatments involved in processing of such leather also causes pollution. Slowly people are getting aware of environmental and ecology concepts. The organizations like PETA are also working to establish and protect animal rights. Faux leather is an alternative to animal-derived leather. It is made either from synthetic materials such as polyvinyl chloride (PVC) and polyurethane (PU) or from bio-based materials which look like real leather. The different terms are used interchangeably to describe faux leather such as vegan leather, imitation leather, artificial leather, leatherette, pleather and PU leather. Market size for faux leather will hit \$89.6 billion by 2025 with a 49.9% compound annual growth rate in the projected time frame (2019-2025). There are many reasons for the increase in popularity of faux leather. The first and foremost reason is that it is a cruelty-free option. Besides, it is economical, low maintenance, more durable (good strength), more elastic and more uniform as compared to real leather.

3rd International Conference on “Global Initiative in Agricultural, Forestry and Applied Sciences for Food Security, Environmental Safety and Sustainable Development (GIAFAS-2021)”

Although synthetic-based leather for eg. PU leather and PVC leather etc is the most common alternative, it is not considered eco-friendly or sustainable due to its high carbon footprint and non-biodegradability. Bio-based faux leather can be derived from various sources like apple peel, banana stem, pineapple leaves (*PinaTex*), coconut, cactus (*Desserto*), mushroom (*MuSkin*), coffee, teak leaves, mulberry leaves (*MulbTex*) and cork of oak tree etc. Some of the bio-based faux leather are still under development like *Fleather* (flower cycling from temple waste), *Zoaleather* (from yeast), *Green tea leather* (layered with hemp and more comfortable than animal-derived leather), *Lab leather* (from microorganisms and 100% biodegradable) and *Soy leather* (from liquid runoff of tofu). The different Indian PETA-certified brands for faux leather from sustainable sources are PAIO, Brokemate, Arture, Aulive, and Malai etc.

Keywords: Real leather, Bio-based faux leather, Vegan leather, imitation leather, artificial leather

DOUBLING THE FARMER INCOME THROUGH INNOVATIVE APPROACH SWATI KUMARI¹ AND RITU KUMARI²

¹*Department of Agronomy, Bihar Agricultural University, Sabour, Bhagalpur- 813210, Bihar*

²*Department of Agriculture, Govt. of Bihar*

ABSTRACT

Now-a-days the population of India is increasing in a sky-rocketing manner and productivity of arable land is still stagnant in present era. Therefore, the challenges are under alarming situation to increase the agricultural productivity in order to feed the growing population. Majority of the Indian farming communities follow traditional practices of agriculture which support their livelihood. Farming in India is often distinguished by small, marginal, and fragmented land holdings (about 86 per cent) and is highly dependent upon the severity of monsoon rains. Operating small holdings is often unfeasible and in this situation, farming is not a profitable business or enterprise. Therefore, there is an urgent need of conversion in agriculture production into combined approach with integrated farming system (IFS) that involves crop cultivation, dairy, poultry, fishery, mushroom cultivation, agro-forestry, piggery, bee keeping, vegetable and fruit production, use of renewable energy source (i.e. Solar energy, Bio gas etc.). For doubling the farmer's income, few vital strategies need to be adopted considering the basic requirements of the farmers. These strategies might be huge investments in agricultural research and development, acceptable adoption of Good Agricultural Practices (GAP), Conservation Agriculture (CA) technology, implementation of farmers' friendly policies, judicious use of available resources and inputs, Site Specific Nutrient Management (SSNM) along with improved market and transportation facility, minimum support price (MSP) reform, supported by adequate and timely availability of bank credits. It has been reported that a rise in MSP will raise farmer income by 13-26 per cent. Smart farming and credit supporting smart farming are other possible approaches in doubling farmer's income. Crop diversification mainly deals with the concerns of high value crops. Economic and socio-ecological access towards sustainable production could only be secured by adopting Farming System Approach (FSR).

Keywords:-GAP, SSNM, IFS, MSP, Doubling farmers income

CONTRIBUTION OF COVER CROPS TO WEED MANAGEMENT IN SUSTAINABLE AGRICULTURAL SYSTEMS

Soni Singh, Tarkeshwar*, Kamlesh Kumar, Govind Mishra and Ravi Prakash Chaudhary

Department of Genetics and Plant Breeding, A.D.A.U.A.&T., Kumarganj, Ayodhya – 224 229 (U.P.)

ABSTRACT

3rd International Conference on “Global Initiative in Agricultural, Forestry and Applied Sciences for Food Security, Environmental Safety and Sustainable Development (GIAFAS-2021)”

Cover crops have become a viable option for sustainable agriculture because of Contributions to soil fertility and improved crop performance. Here we focuses on weed control and summarizes present knowledge of the contribution of cover crops to managing weeds in sustainable agricultural systems. Residue from winter annual cover crops provides early-season weed suppression but not full-season weed control. Living mulches that are effective at controlling weeds also will require management to prevent excess competition with the cash crop. Elimination of herbicides is not a realistic objective for using cover crops. Rather, herbicides should be considered a tool for managing cover crops and optimizing their potential for improving soils and sustaining agricultural production. Cover crops have become a viable option for sustainable agriculture because of contributions to soil fertility and improved crop performance. The contribution of cover crops to weed management is not clearly defined. Ideally, weed control could be improved if a manageable cover crop could replace an unmanageable weed population in the agro-ecosystem.

Keywords: *sustainability, crop residues, cover plants, cultural control, live mulches*

EXPLOITAION OF DIVERSITY IN WHEAT TO IMPROVE GRAIN YIELD, CLIMATE RESILIENCE AND NUTRITIONAL VALUES USING MODERN BREEDING APPROACHES **Tarkeshwar^{1*}, Soni Singh¹, Kamlesh Kumar², Ravi Prakash Chaudhary¹, Govind Mishra¹, Mohit Yadav² and Mohammad Salman¹**

Department of Genetics and Plant Breeding

¹*Acharya Narendra Deva University of Agriculture and Technology, Kumarganj, Ayodhya (U.P.)- 224 229*

²*Baba Raghav Das Post Graduate College, Deoria (U.P.)- 274 001*

ABSTARCT

The rising demand for wheat has caused a significant increase in the global supply of the cereal. However, the effects of climate change and various pests and diseases have affected the wheat production. Climate change and the evolution of pathogens and pests are some of the factors that threaten the growth of wheat production globally. The increasing population and the economic conditions have caused wheat consumption to increase in developing nations. Climate change has affected the production of wheat in recent years. According to various crop models, the average yield of wheat has decreased by around 6–13% for each degree Celsius increase in temperature. In 2050, the productivity of wheat will need to increase to 1 t/ha to meet the rising global demand. A polygenic trait, grain yield per se is produced by the introduction of alien introgressions. These traits can improve a variety of factors such as abiotic stresses and grain size. Landraces are a crucial germplasm pool that can contribute genes for improved grain yield. Improvement of the nutritional quality of wheat breeding can help improve its yield and reduce its biotic stresses. Extensive effort is required to transfer genes from diverse sources to produce cultivated varieties. Around 17.3% of the world's population is at risk of not having enough zinc, which is a factor that affects growth in children. Through the introduction of novel alleles into elite germplasm, the development of biofortified wheat has significantly impacted global production. Ingenious genes are being introduced into wheat to improve the quality of life by introducing higher grain Zn. This process involves introducing multiple genes from diverse sources. Due to the lack of adequate zinc and iron in diets, these nutrients are very important for the proper growth and development of tissues. Development of gene cassettes could help solve the problems related to sexual incompatibility and other forms of discrimination.

Keywords: Wheat, climate resilience, nutritional security, diversity, grain yield.

NEW PROTOCOL FOR ESTIMATING POTENTIALLY AVAILABLE PHOSPHORUS IN ORGANICALLY MANAGED ACIDIC SOILS

Pritisha Patgiri* and Sanjay-Swami

School of Natural Resource Management

College of Post Graduate Studies in Agricultural Sciences, Central Agricultural University, Umiam (Barapani) - 793 103, Meghalaya, India

ABSTRACT

Acidic soils render phosphorus mostly deficient due to fixation and precipitation of the phosphate ions in the iron and aluminium oxides and hydroxides. Proper replenishment of the soil P is very much important to cater the need of plant P requirement for better yield and development. The agricultural soils of Meghalaya are by default organic in nature and organic P pool contributes 15 to 80% of the total plant P nutrition. Moreover, a different nature of nutrient pools is evident in organic farming system compared to the conventional system. Lack of knowledge of these pools results in an unbalanced manuring plan which hinders successful crop production. The dynamic fraction of P, which is considered in conventional soil testing, cannot explain the correct status of phosphorus in soils under organic production systems as the conventional soil testing protocols do not take into account the potentially available inorganic pools of phosphorus. Hence, a different extractant which can extract such potentially available P in an acidic soil under organic production system is highly required. The mineralization, solubilization and extraction of the potentially available P pool by various organic acids produced by the beneficial soil microorganisms can serve this purpose. Therefore, the present research work was carried out to identify the best suitable P extractant to extract such potentially available inorganic P pool. Result revealed that in comparison to the conventional Bray 1 extractant, 2% citric acid and double lactate extractants, among 6 different tested extractants were found to be strongly correlated to the total P. Hence, 2% citric acid and double lactate extractants may be proclaimed as the promising extractants which can best estimate the potentially available phosphorus pools in organic farms of Meghalaya and the soil must be tested with these extractants to march towards a successful organic cultivation.

Keywords: Phosphorus, pools, extractants, acidic soil, organic farming system, soil testing protocol.

Digital Learning: The new face of Education in the course of Covid-19 pandemic

Dipankar Saikia*¹, Bidyut P. Gogoi², Abhijit Das³ and Manisha Barman⁴

¹*Department of Extension Education, Dr. Rajendra Prasad Central Agricultural University, Samastipur, Bihar, India*

²*Department of Extension Education, Dr. Rajendra Prasad Central Agricultural University Samastipur, Bihar, India*

³*Dairy Economics and Statistics Section, SRS of ICAR- National Dairy Research Institute, Bengaluru, Karnataka, India*

⁴*Department of Extension Education, B.N. College of Agriculture, Assam Agricultural University, Biswanath, Assam, India*

ABSTRACT

India boasts the world's second-largest education system, after China. Covid-19 outbreak has a tremendous influence on their lives. Students has no longer have one-on-one encounters with their teachers. In this time of turmoil, it is difficult to give uninterrupted education. There must be a mid-way where students and teachers can interact without actually being together. Distance learning has grown in popularity over the previous 10 years. Many other online courses, such as SWAYAM and MOOCs, have been produced by various organizations, and students have been enrolling in them to learn more. Colleges, on the other hand, have never embraced the idea of taking online classes to fulfil a conventional course schedule. Because to Covid-19's disruptions, colleges were forced to offer classes online. As a result, traditional classroom instruction has given way to technology-assisted online learning. Several public and private institutions have switched from traditional classroom instruction to digital classroom instruction. Teachers are working hard and making themselves available 24 hours a day for kids across the country to help ease the hardship and disturbance. They have begun instructing their students via online

3rd International Conference on “Global Initiative in Agricultural, Forestry and Applied Sciences for Food Security, Environmental Safety and Sustainable Development (GIAFAS-2021)”

classes in order to ensure that the global pandemic has no impact on the students' education. The future of Indian education will be digital learning. It will be a useful tool for both educators and students in the coming years. Without a doubt, the transition from traditional classroom instruction to computer-based instruction is one of the most significant educational experiments ever undertaken. Because of Covid-19, virtual teaching-learning procedures are becoming more common in India. As a result, it's critical to comprehend its technique, development, and promise in India. After Covid-19, it will be feasible to transform higher education. Educational Institutions should take advantage of this opportunity to improve. Today is Covid-19 Day!! Nobody is aware what awaits us in the future.

Key Words: Digital Learning, Online learning, Teaching, Covid-19

Digestive, meatabolic and antioxdant enzyme activities of *Labeo bata* (Hamilton, 1822) adults fed with dietary neem oil and nonylphenol

Prasanta Jana^{1,*}, Gour Hari Pailan², Narottam Prasad Sahu¹, Subrata Dasgupta², Saumya Kanti Ray², Bijay Kali Mahapatra²

¹*Fish Nutrition, Biochemistry and Physiology Division, ICAR-Central Institute of Fisheries Education, Mumbai-400 061, India*

²*ICAR-Central Institute of Fisheries Education, Kolkata centre, 32, GN Block, Salt lake, Sector V, Kolkata-700 094, India*

ABSTRACT

A 90-day feeding trial was conducted to study the effect of neem oil and or nonylphenol on digestive, meatabolic and antioxdant enzyme activities of *Labeo bata* adults. Two hundred twenty five *L. bata* (avge. wt., 48.47±1.09 g) were randomly distributed in five treatments following completely randomized design in triplicates. Five iso-nitrogenous, iso-caloric and iso-lipidic (30% crude protein, 367 kcal/100g digetible energy, 6% lipid) practical diets were prepared viz., C (no supplements), T₁ (0.5% neem oil), T₂ (0.5% nonylphenol), T₃, 1% combined dose (0.5% neem oil + 0.5% nonylphenol) and T₄, 2% combined dose (1.0% neem oil + 1.0% nonylphenol). No significant difference ($P>0.05$) was observed in the protease, lipase and amylase enzyme activities but higher values were observed in T₃ and T₄ groups fed with neem oil and or nonylphenol in combination. Highest ($P<0.05$) muscle and hepatic aspertate aminotransferase (AST), alanine aminotransferase (ALT) and lowest ($P<0.05$) superoxide dismutase (SOD), catalase enzyme activities were recorded in T₄ group. The findings suggest that dietary neem oil and nonylphenol supplementation at 2% level (1:1) can improve the digestive, meatabolic and antioxdant enzyme activities to support increased somatic growth in adult *L. bata*.

Keywords: *Labeo bata*, Neem oil, Nonylphenol, digestive enzymes, metabolic enzymes, antioxidant enzymes

Developing novel NPK Biofertilizer Consortium for Minor Millets

R. Thamizh Vendan and T. Boobalan

Department of Agricultural Microbiology, Agricultural College and Research Instt., Tamil Nadu Agricultural University, Madurai- 625 104 Tamil Nadu.

ABSTRCAT

Millets are one of the oldest food grains that are cultivated by humans and it was a staple food in India and China before the popularity of fine cereals like rice and wheat. To meet the recent and forthcoming demands of millet grains, chemical fertilizers are being applied for increasing the production, which may escalate the cost of cultivation significantly and also affect the soil biota.

A solution to meet the demands without affecting the soil health is the inoculation of microbial biofertilizers to the crops, which are sustained in the soil for a long time and supply the nutrients required for the crops. But the application of inoculants like N fixer, Phosphate solubilizing bacteria (PSB), and Potassium releasing bacteria (KRB) individually is time consuming and increased the application charges which eventually resulting in the cost of cultivation. So,

3rd International Conference on “Global Initiative in Agricultural, Forestry and Applied Sciences for Food Security, Environmental Safety and Sustainable Development (GIAFAS-2021)”

this study was mainly focused on developing NPK biofertilizer consortium, which supplements all the three major nutrients required for millet crops in a single pack/dose.

Initially, 18 bacterial isolates were isolated from the rhizosphere soil of minor millets rhizosphere by using the sieved soil plate method. The isolated cultures were screened for N₂ fixation, P and K solubilization by using the appropriate screening methods. Among the 18 isolates, BM-5, PM-1 and BM-2 were selected as elite cultures for N₂ fixation, P solubilization, and K releasing respectively based on the results. They identified as *Bacillus nealsonii* (BM-5), *Bacillus velezensis* (PM-1) and *Pseudoxanthomonas indica* (BM-2) respectively by using 16s rRNA sequences. The compatibility of the above organisms was studied and NPK consortium was developed. The developed NPK consortium showed better performance in all PGPR traits viz., N₂ fixation, P solubilization, K mobilization, production of IAA, GA, ACC deaminase, siderophore, ammonia, and HCN than the test cultures. The superior performance of developed NPK consortium over the test cultures might be due to the synergistic effect created during the growth of two or more organisms together in an environment. This NPK consortium could be very well used for minor millets to enhance their productivity without affecting soil health.

Diversity and Functionality of Seed Vectored Bacterial Endophytes in *Triticum aestivum* L. across Boundaries of Cultivars and Ecology

Jogdande Sai Prasad, Archana Suman

Division of Microbiology, ICAR-Indian Agricultural Research institute, New Delhi

ABSTRACT

The present work demonstrates wheat seed endophytic bacterial (WSEB) taxonomic structure, potential PGP functions, colonization in the plant growth. Isolated and purified total 220 bacterial isolates based on multifarious PGP activities; genotypic characterization of 62 isolates using 16SrRNA gene, revealed 7 different genera with 20 distinct species falling into 3 phylum Firmicutes (85.48%), Proteobacteria (9.67%) & Actinobacteria (4.83%), with predominant genera *Bacillus* in Firmicutes. The 16SrRNA gene sequences of 62 isolates submitted to NCBI GenBank (Accession Nos; MT184815-MT184873, MT672532- MT672534).

Quantification of PGP activities *P. putida*-NWP-10, *P. agglomerans*-NH-4, *B. cereus*-NWP-5 isolates exhibited maximum N₂ fixation, P-solubilization and IAA respectively. In antagonism assay, 33/62 isolates showed >65% inhibition to 3 pathogens. Live cells staining using TTC, DAB-H₂O₂ and biomarker tagging of *gfp* vector pCambia-1302 tracked in different plant parts. Based on two pot and field experiments with 3 wheat species and 4 levels of fertilizer inputs concluded finally *P. agglomerans*-NWPZ-9, *P. putida*-NWP-10, *B. megaterium*-NEP-22 are adjudged as the best seed endophytes.

Key words: WSEBs, identification, staining, GFP tagging and tracking, Pot & Field experiments

An ethno botanical study of medicinal plants used to treat gastrointestinal ailments of district Kupwara of Jammu and Kashmir.

Aadil Abdullah*¹, Dr. Syed Aasif Hussain Andrabi²

1. *department of life science, Glocal University Saharanpur-247121 (U.P)*

2. *School of Agricultural Science, Glocal University Saharanpur-247121 (U.P)*

ABSTRACT

Gastrointestinal diseases are the most important and fragile organ of the human body, which can cause various diseases such as abdominal pain, constipation, diarrhea, Anthelminthic, and many other diseases. To treat these diseases, the residents of the district Kupwara of Jammu and Kashmir use wild herbs that grows in forests and high-altitude alpine regions of the study area. Most of these medicinal plants are common in occurrence, but there are no early reports of their use in treatment of gastrointestinal diseases. The purpose of this research study is to narrow the list of medicinal plant species used to cure gastrointestinal diseases in district Kupwara based on oral traditional knowledge. A total of 67 plant species representing 31 families are reported to treat different gastrointestinal diseases. Where in *Aconitum heterophyllum* has shown the maximum

3rd International Conference on “Global Initiative in Agricultural, Forestry and Applied Sciences for Food Security, Environmental Safety and Sustainable Development (GIAFAS-2021)”

use value (0.69) and *Verbena officinales* has shown the minimum UV (0.17). This is the first ethno botanical study of medicinal herbs utilized by the local people of district Kupwara of Jammu and Kashmir for against gastrointestinal diseases.

Key Words: Gastrointestinal, Traditional Knowledge, Ethno medicine, Kupwara, Medicinal plants.

Response of Integrated Nutrient Management on quantitative and qualitative parameters of Ber (*Ziziphus mauritiana L.*) cv. Apple ber

¹EESHWAR SAHU, ²SEVAN DAS KHUNTE, AND K.K. YADAV

¹ Department of Fruit Science, College of Agriculture, Rajmata Vijayaraje Scindia Krishi Vishwa Vidyalaya Gwalior (M.P.) 474002

²Department of Fruit Science, College of Agriculture, IGKV, Raipur (C.G.) 492012

ABSTRACT

The present experiment entitled “**Response of Integrated Nutrient Management on quantitative and qualitative parameters of Ber (*Ziziphus mauritiana L.*) cv. Apple Ber**” was conducted at Dry land Horticulture Farm, Sirsod, College of Agriculture, Gwalior (M.P.). The data was collected on morphological Parameters viz. plant height (m.), leaf length (cm.), canopy spread • North-South • East-West, shoot diameter at 30, 60, 90 days (mm.), shoot length at 30, 60, 90 days (cm.), number of leaves per shoot at 30, 60, 90 days, number of primary and secondary branches on selected shoot. The maximum vegetative growth of plant in terms of plant height (2.17 m), leaf length (4.25 cm), canopy spread (N-S) 4.95 m were recorded under T₁ (100 % RDF + Azotobacter @5 ml/ plant). The treatment T₅ (75% RDF + Azotobacter @5ml/plant + Vermicompost @10 kg/plant) performed the best in most of the cases. The maximum number of branches (25.00) and shoot diameter was recorded 106.25, 139.18 and 150.64 mm at 30, 60 and 90 days respectively. The maximum yield (49.19 kg), fruit weight (82.20g), fruit volume (85.93 cm³), specific gravity of 0.84, T.S.S. 9.53 ° Brix and acidity (0.24%) were recorded under T₅ (75% RDF + Azotobacter @5ml/plant + Vermicompost @10 kg/plant). The highest B: C ratio (4.87) was recorded with treatment T₆ (75% RDF + PSB @5ml/ plant).

KEY WORDS: Azotobacter, Ber, FYM, NPK, PSB and Vermicompost.

Integrated Management of Diamondback Moth in cabbage in western plateau of Jharkhand Sub Zone V

Nazrussalam, and D. N. Singh

Zonal Research Station, Chianki, Palamau-822102, Jharkhand, (Birsra Agricultural University, Ranchi, Jharkhand, India)

ABSTRACT

Cabbage (*Brassica oleracea* var. capitata) is a popular cruciferous vegetable crop is being grown throughout the world. China is the top producer of cabbage followed by India and Russia. The diamondback moth (DBM), *Plutella xylostella* (Linn.) (Lepidoptera: Plutellidae) is the most widely distributed species, and occurs wherever cruciferous crops are grown. A field experiment was conducted during Rabi 2020-21 on Integrated Management of Diamondback Moth in cabbage in western plateau of Jharkhand Sub Zone V at Zonal Research Station, Chianki in a Randomized Block Design with three replications and eight treatments. Hybrid cabbage, Green Queen (NCAH-680) variety was transplanted in the last week of November. All the treatments were recorded significant reduction in the larvae and pupae of DBM at 3, 7 and 10 days after spraying over control. The spinosad 2.5% SC @ 2.0 ml/ l. proved to be significantly superior treatment followed by *Beauveria bassiana* @ 4.0 g/l, *Metarhizium anisopliae* @ 5.0 g/L and *Bacillus thuringiensis* var. Kurstaki @ 2.0 g/l. against DBM. Foliar application of spinosad at 30, 45 and 60 days after transplantation (DAT) found significantly the most effective treatment registering 88.10, 96.06 and 97.87 percent reduction over control in the population of DBM in all the three sprays,

3rd International Conference on “Global Initiative in Agricultural, Forestry and Applied Sciences for Food Security, Environmental Safety and Sustainable Development (GIAFAS-2021)”

respectively, which produced the maximum marketable yield of cabbage (721.30 q/ha). While control plot produced the lowest yield of cabbage (435.08 q/ha) and recorded the maximum number of larvae and pupae per plant (13.67, 17.67 and 21.33) at 10 days after spraying, respectively in all the three spraying schedule. However substantial difference was obtained in spinosad and *Metarhizium anisopliae* in all spraying schedule.

Key words: Cabbage, *Plutella xylostella*, population, integrated management, yield

CARBON CREDIT: A BOON FOR THE ENVIRONMENT

Arpita Grover¹, Mona Verma² and Dr. Saroj S. Jeet Singh³

Department of Textile and Apparel Designing, I.C. College of Home Science,, Chaudhary Charan Singh Haryana Agricultural University, Hisar-125004 (Haryana), India

ABSTRACT

Clothing is an essential part of human life. Over the last few decades, spurt in population and improved living conditions have resulted uptick in production and consumption of clothing and textiles, this generates a lot of textile waste in different sectors of textile industry. Furthermore, the rapid-paced fashion cycle requires more frequent product substitution with newer, more unique products, resulting in increased textile waste. So the amount of greenhouse gas (GHG) emission continues to rise. Concentration of greenhouse gases is increasing in atmosphere which is disrupting the activities and affecting the environment. This leads to global warming. Carbon footprint is a measure of the severity of the impact our activities have on the environment, and particularly on climate change. It gauges the effect by estimating the volume of greenhouse gases released into the atmosphere as a result of the combustion of fossil fuels for electricity, heating, and other purposes in our routine lives. Carbon dioxide is the major contributor to global warming, accounting for almost 80% of emissions from textile industries. Ever increasing of concern about the climate change and greenhouse gas emissions have compelled the textile industry to not only minimize its carbon footprint of goods, facilities, and activities, but also to exchange carbon credits, offset its carbon emissions, and adopt carbon-neutral approaches. This is one of the only clear and effective approaches to modify carbon credit markets in order to enhance their performance in terms of reaching actual carbon reduction. This can act as a source for the discussion of the carbon footprint of the textile sector, as well as the strategies applied to balance or reduce emissions.

Keywords- Textile Waste, Greenhouse gas, Global Warming, Carbon Footprint and Carbon Credit.

Assessment of physical and chemical effect of mutagenesis on germination, pollen fertility and plant survival in M₁ generation of wheat (*Triticum aestivum* L.)

AMIT RANA^{1*}, VIJAY RANA^{1,2}, PRIYANKA¹, CHETAN GUPTA¹, RUPALI CHOUDHARY¹ AND A. K. SARIAL¹

¹*Department of Genetics and Plant Breeding, CSK Himachal Pradesh Krishi Vishvavidyalaya, Palampur (H. P.), India-176062*

²*Rice and Wheat Research Centre, Malan, CSK Himachal Pradesh Krishi Vishvavidyalaya, Palampur (H. P.), India-176047*

ABSTRACT

Genetic variability for economic traits is pre-requisite for any successful plant breeding programme. A powerful approach for deciphering the biological functions of genes is to produce mutants through mutagenesis. Selection of efficient mutagens and their treatment doses is prerequisite for successful mutagenesis as mutagens are potential tools for direct improvement of

3rd International Conference on “Global Initiative in Agricultural, Forestry and Applied Sciences for Food Security, Environmental Safety and Sustainable Development (GIAFAS-2021)”

certain qualitative and quantitative characters. Mutagenesis studies comprising of four wheat varieties i.e. HS 490 (soft), HPW 89 (soft), HPW 251 (hard) and HPW 360 (semi-hard) were treated with six doses each of gamma rays viz., 175 Gy, 200 Gy, 225 Gy, 250 Gy, 275 Gy, 300 Gy and different concentrations of ethyl methane sulphonate (EMS) viz., 0.30%, 0.50%, 0.70%, 0.90%, 1.10% and 1.30% to study the impact of mutagens on germination, pollen sterility reduction and plant survival in M₁ generation under field conditions.

The results indicated that the reduction in germination percent over control was noted in all mutagenic treatments of all the four varieties for both the mutagens. At 300 Gy, lowest germination of 36% and 35% in HS 490 and HPW 251 was recorded in case of gamma radiations whereas 41% and 35% germination were recorded in 1.30% concentration in HPW 360 and HPW 251 respectively. Probable delay in the one set of mitosis and chromosomal aberration induced enzyme activity leads to reduced germination, while increased pollen sterility was associated with corresponding increases in dose/ concentration of mutagens. It was observed that the pollen sterility increased with increasing dose/ concentrations of mutagens. Highest pollen fertility reduction up to 11.6% in 300 Gy and 8.9% pollen sterility in 1.30% over control were observed in HPW 251. In most cases meiotic abnormalities are responsible for reduction in the pollen fertility. The decrease in survival percentage was associated with increases in the dose/ concentration of the mutagens in all the varieties. At 300 Gy, HS 490 and HPW 251 showed lowest plant survival of 34% and 30% respectively whereas 38% and 37% over control for 1.30% concentration in HPW 360 and HPW 251 respectively. Among both the mutagens, gamma rays were more effective as compared to EMS and control. Lower dose/ concentrations of both mutagens produced less biological damage and would be suitable for inducing desirable attributes in wheat establishing varietal effect of mutagens like gamma rays and EMS in different wheat varieties to be used in inducing large scale mutagenesis in wheat.

Physio-chemical analysis of quality, evaluation and development of Bottle gourd lemon mint squash

¹*Ashish Kumar

ABSTRACT

Bottle guard lemon mint Squash is an innovative & unique idea to use all the three ingredients in the combination as all three contains fibres in it. Bottle gourd is tasteless and due to this reason less people consume it. It is alternative form for individuals to consume bottle gourd. Bottle gourd is an important vegetable of summer as well as rainy season. It is good source of nutrients, vitamins and fibres. Bottle gourd contains 96% water in it and it is good for digestion. Lemon is rich in vitamin C, citric acid as well as possessing anti-bacterial properties. The anionic food, lemon, is the sole anionic food in the world. This makes it good for health as it provides all cell energy by interaction between the anions and cations. Mint is rainy as well as winter season herb. It is source of vitamins, fibre and minerals. It refreshes our mouth and has a variety of medical benefits.

Different combinations of bottle gourd, lemon & mint are prepared in laboratory. 8 samples are prepared with different concentrations of all three ingredient. 8 blends of bottle gourd, lemon & mint were taken in then ratio R₀- 100:0:0, R₁- 90:10:0, R₂- 80:17.5:2.5, R₃- 80:15:5, R₄- 70:27.5:2.5, R₅- 70:25:5, R₆- 60:37.5:2.5, R₇- 60:35:5 with R₅ being the best in terms of sensory acceptability. It possessed good amount of total soluble solids and acceptable amount of sugar. The blended juice has vitamin C (4.67 mg/ml) TSS (10 °brix) and Acidity (3.9%). Squash was found palatable and good flavour. Due to its nutritional and functional features, squash is helpful to one's health and can be used to treat a variety of disorders.

Keywords- Bottle gourd, Lemon, Mint, TSS, Acidity, Squash.

Impact of salt stress on the growth, morphological as well as physiological attributes of *Cicer arietinum* and alleviation potential of microbial inoculants to overcome salt stress

ZEENAT MUSHTAQ*, BASIT GULZAR AND SHAHLA FAIZAN

Environmental Physiology laboratory, Department of Botany, Aligarh Muslim University, Aligarh 202002 (U.P)

ABSTRACT

Soil salinity is regarded as the major hurdle for the cultivation of crops especially in the arid and semi-arid regions of the world causing drastic reduction in the yield of crops plants, threatening the global food production potentials. Inoculating the crop plants with the growth promoting microbes will certainly help the plant to overcome the adverse effect of salt stress and make the plants to survive better under salt stress condition and to produce healthy yield. So, the current study was carried to

3rd International Conference on “Global Initiative in Agricultural, Forestry and Applied Sciences for Food Security, Environmental Safety and Sustainable Development (GIAFAS-2021)”

investigate the impact of different concentrations (0, 50 and 150) of NaCl on growth, morphological, physiological characteristics as well as yield of *C. arietinum* and role of microbial inoculants (*Rhizobium* and AMF) in alleviating the NaCl induced toxicity. Our results revealed that combined application of AMF and *Rhizobium* not only alleviated the NaCl-induced effects but also increased growth, morphological, physiological characteristics as well as yield attributes of *C. arietinum* plants. So, it is concluded that application of microbes considerably alleviated NaCl-induced toxicity in *C. arietinum* and can be recommended for enhancement of yield production of chickpea plants grown under salt stressed conditions.

Isolation and characterization of endophytic bacteria in rice

Chindam swathi., Dr. Bharati N. Bhat., Dr. G. Uma Devi., Dr. S. Triveni and Dr.S.N.C.V.L. Pushpavalli

Department of Plant Pathology, College of Agriculture, Professor Jayashankar Telangana State Agricultural University, Rajendranagar, Hyderabad-030, Telangana, India.

ABSTRACT

Rice (*Oryza sativa* L.) is one of the important staple food for the increasing population and grown extensively in the tropical and subtropical regions of the world, out of which 90% of rice grown in the world is produced and consumed in Asia. In Telangana, the crop is grown to an extent of 1.7 Mha with a production of 5.8 Mt and productivity of 3387 kg ha⁻¹ (INDIASTAT., 2017-2018). Endophytes play an important role in the functioning of the host plant by influencing their physiology and developmental processes. Bacterial endophytes are known to be involved in imparting tolerance or resistance to the host plant from various biotic and abiotic stresses by releasing antimicrobial metabolites, synthesizing phytohormones, siderophore, competing with pathogens for space and nutrients and modulating the plant resistance response. In view of the economic importance of the crop considerable attention has been given on the development of endophytic bacteria as biological control and is the most effective, eco-friendly and economically feasible.

Eighty endophytic bacterial isolates were isolated from the roots, stem and leaves by serial dilution method The isolates were purified, colony characters were recorded. The genotype BPT 5204 supported significantly higher mean endophytic bacterial population. All the isolates were screened for antagonistic activities against Bacterial leaf blight by cross streak method. Fifteen isolates showed inhibition zone. For this fifteen isolates biochemical characterization like siderophore, HCN, IAA, catalase, citrate, oxidase, hydrogen sulphide, indole, voges prausker's, casein, gelatin, pectinase, cellulose, phosphate solubilisation tests were performed. Further, fifteen isolates were screened for antagonistic activity by agar well diffusion method. Five isolates were effectively showing antagonistic activity positive to all growth promoting activities under *in vitro*. So, five isolates can be used as biocontrol agents as well as to increase the growth promoting activities in rice varieties to increase the yield of the crop.

Effects of Silicon on Growth, Yield and Quality Attributes of *Artemisia annua* under Copper stress

Andleeb Zehra*, Sadaf Choudhary, Mohammad Mukarram, Kaisar Iqbal Wani and Tariq Aftab

Advanced Plant Physiology Lab, Department of Botany, Aligarh Muslim University, Aligarh, 202002, U.P., India

ABSTRACT

The micronutrients could cause severe toxicity to plants at higher concentrations. In this investigation, copper (Cu) toxicity caused morphological and cellular damages to the *Artemisia annua* L. plants but application of silicon (Si) ameliorated the damaging effects of Cu. Copper toxicity reduced the growth and photosynthetic attributes of the plants. However, exogenous application of Si to Cu-treated plants significantly alleviated the harmful effect on plants by metal stress. Deposition of Cu resulted in oxidative stress in plants as evident by increase in 2-thiobarbituric acid reactive substances (TBARS) content and catalase (CAT), peroxidase (POX) and superoxide dismutase (SOD) enzyme activities. However, addition of Si prevented

3rd International Conference on “Global Initiative in Agricultural, Forestry and Applied Sciences for Food Security, Environmental Safety and Sustainable Development (GIAFAS-2021)”

adverse effects of Cu toxicity and prevented excess of Cu in root and shoot tissues and TBARS content in the cells of disturbed plants. The significant deleterious impact of high concentrations of Cu on density and ultrastructure of glandular trichomes and artemisinin content was also noticed. Furthermore, the Si supplementation improved the density of glandular trichomes and protected the plant tissues from Cu toxicity, thereby upregulating artemisinin biosynthesis. Therefore, the results indicated that the exogenous application of Si protect *A. annua* plants from Cu toxicity by preventing deposition of Cu in root and shoot tissues, by increasing the antioxidant capacity, which maintained the structure and integrity of leaves and also helps in increased artemisinin production.

Keywords: Copper toxicity, Silicon, *Artemisia annua*, Artemisinin, Glandular trichomes.

Breeding for Salt Tolerance: Conventional and Molecular Approaches

Rubina Khan*, Dr. S. S. Punia¹

Department of Plant Breeding and Genetics, S.K.N. Agriculture University Jobner, Jaipur 303328 (Rajasthan)

Department of Plant Breeding and Genetics, S.K.N. Agriculture University Jobner, Jaipur 303328 (Rajasthan)

ABSTRACT

Salinity is a soil condition characterized by a high concentration of soluble salts such as Calcium, Magnesium and Sodium and their anions. Salinity affects about 1000 million hectares land globally posing a formidable task of taking up agriculture and enhancing productivity in these areas. In India, 6.73 million ha land is salt affected, out of which 3.77 and 2.96 million ha are covered by sodic and saline soils respectively. Salinity has negative impact on agricultural productivity affecting plant growth and restricting the use of land. Reclaiming salt-affected areas by chemical amendments and drainage interventions is one option to control soil salinity, however it involves higher costs which are generally beyond the economic access of poor and marginal farmers. Plant breeding approaches (conventional and molecular) are more suitable in case of salinity stress as they are simple and more economical to adopt by small and marginal farmers. Scientists have already used various plant breeding techniques like selection, mutation and wide hybridization to develop salinity stress tolerant varieties for different crops. Modern tools and techniques such as molecular marker-assisted selection is also being integrated into conventional breeding programs to increase the pace and efficiency of the varietal development process. A new salt tolerant wheat variety named Hanaa had been developed by using integrated approach of in vitro mutation breeding programme. A salt tolerant rice variety named PSBRc50 or Bicol had been developed by using F₁ anther culture derivatives. Salt Tolerant IR64 Near Isogenic Lines (NILs) has also been developed by using the Marker Assisted Backcross Breeding (MABB) approach. A salt tolerant QTL named *Saltol* has been integrated into cultivated varieties of rice by using molecular approaches. Still there is scope of further improvement in development of new salt tolerant genotypes as robust screening techniques have been developed, the screening criteria and selection pressure are well elucidated, the genetics of salt tolerance are better understood and suitable genetic donors have been identified.

Keywords: Salinity, salt tolerance, sodic and saline soils, conventional approaches and molecular strategies.

A Review on Important Sorghum Insect Pests: Biology, Ecology, and Management

Rajendra Kumar¹ and Sakshi Saxena²

¹ Entomology, MBDDSMKM, Siswali, Baran, Rajasthan-325006

² College of Agriculture, RVSKVV, Gwalior, MP-474002

ABSTRACT

Sorghum, *Sorghum bicolor* L. (Gramineae), is a highly coveted crop grown all over the world, with grain and forage considered equally in some developing nations. Sorghum may provide high yields even in harsh environments, however insect pest damage at various phases of the plant's life can impair output, affecting low-income farmers in developing nations. Leaf-sucking insects, leaf-feeding insects, stalk or stem borers, panicle and stored grain pests are all common sorghum insect pests. Cultural controls, biological controls, pesticides (chemical, botanical, or microbial), and host plant resistance are all examples of modern control techniques. To protect natural enemies at the landscape level, an integrated

3rd International Conference on “Global Initiative in Agricultural, Forestry and Applied Sciences for Food Security, Environmental Safety and Sustainable Development (GIAFAS-2021)”

approach is proposed, based on a mix of insect growth regulators and conservation efforts. Sorghum resistant genetics have been discovered through genetic study, and insect-tolerant sorghum cultivars have been identified. Various control strategies have been established, however for increased sorghum biomass productivity, more effective management is needed. Long-term successful management also requires regulatory policies to limit the invasion of recent pests.

Effect of biopolymer treatment on dyeing of cotton fabric with natural dye

Mona Verma* and Saroj S. J. Singh

Deptt. of Textile and Apparel Designing, I. C. College of Home Science , Chaudhary Charan Singh Haryana Agricultural University, Hisar

ABSTRACT

Natural dyes are soft in colour shades compared to synthetic dyes. Besides, with the increase of the worldwide concern for the environment, the possibility of using natural dyes is being studied because natural dyes may overcome the defects of synthetic dyes such as harmfulness to human body, pollution and waste water. Accordingly there have been active researches for the natural dyeing. Natural dyes consume 75% of 48,000 tonnes of dye stuff produced in the country. The market for the natural dyestuffs is though very small but has a growing trend. Many textile manufacturers are not using these dyes regularly because these dyes are not easily available in ready form and finally the process of natural dyeing become more expensive than synthetic dyes. Researchers are however working to find out a cost effective way of dyeing with natural dyes, but at the same time efforts are on for obtaining reproducible shades with appreciable colour fastness properties. In the present study, the pomegranate rind was used as a dye. The three biopolymers i.e. chitosan, beta-cyclodextrin and sericin were used as mordants and alum was used as controlled mordant. Among all three biopolymer treated samples dyed with natural dyes, chitosan treated pomegranate rind dyed sample exhibited highest percent dye absorption(56.8 6%), colour strength (13.79 k/s) and wash fastness (4) grades and which was equivalent to the alum treated fabric (controlled) dyed fabric. It was found that the chitosan treated dyed sample showed the highest colour properties and can be used as ecofriendly mordant in dyeing of cotton fabric as it biodegradable and non toxic in nature .

Key Words: Natural Dye, Cotton Fabric, Chitosan, Pomegranate.

Studies on Genetic diversity Analysis in Rice bean [*Vigna umbellata* (Thunb.) Ohwi and Ohashi] Germplasm

M. Singh^{1*}, V. Kumar* and R. Arya^{2*}

^{1} Department of Seed Science and Technology, College of Horticulture, Dr. Y S Parmar University of Horticulture and Forestry, Nauni, Solan-173230 (H.P).*

^{2}Department of Crop Improvement, V. C. S. G. Uttarakhand University of Horticulture and Forestry, College of Forestry, Ranichauri Campus, TehriGarhwal, Uttarakhand*

^{3}, Department of Seed Science and Technology, College of Horticulture, Dr. Y S Parmar University of Horticulture and Forestry, Nauni, Solan-173230 (H.P.)*

ABSTRACT

The present investigation was conducted during *Kharif*, 2014 at Research Block, Department of Crop Improvement, V. C. S. G. Uttarakhand University of Horticulture and Forestry, College of Forestry, Ranichauri Campus, Tehri Garhwal, Uttarakhand. The 28 diverse genotypes of rice bean including three checks *viz.*, PRR-1, PRR-2 and BRS-1 were evaluated in Randomized Complete Block Design with three replications. The characters studied were days to 50 per cent flowering, days to maturity, plant height, stem thickness, number of primary branches per plant, leaflet size, number of pods per plant, number of seeds per pod, pod length, 100 seed weight and seed yield per plant. The twenty eight genotypes of rice bean were grouped into six clusters irrespective of geographical diversity, indicating no parallelism between geographic and genetic diversity. The cluster pairs exhibiting very high inter-cluster distances were cluster IV and V, cluster II and IV, cluster I and cluster IV, cluster III and IV. Considering cluster mean and genetic distance the crossing of entry of clusters IV with entries of cluster V and those genotypes of cluster II, I and III

3rd International Conference on “Global Initiative in Agricultural, Forestry and Applied Sciences for Food Security, Environmental Safety and Sustainable Development (GIAFAS-2021)”

with the entries of cluster IV would be fruitful for obtaining transgressive segregants for developing high yielding and better quality rice bean varieties.

Keywords: Genetic diversity, yield and rice bean

Doubling Farmers Income by Tissue Culture Approaches

R.A. Jadhav

Department of Agricultural Botany, College of Agriculture, Vasant Rao Naik Marathwada Krishi Vidyapeeth, Parbhani-431402 (Maharashtra)

ABSTRACT

Plant tissue culture known as growing and multiplication of cells, tissues and organs of plants on defined solid or liquid media under aseptic and controlled environment. The commercial technology is primarily based on micropropagation, in which rapid proliferation is achieved from tiny stem cuttings, axillary buds, and to a limited extent from somatic embryos, cell clumps in suspension cultures and bioreactors. The cultured cells and tissue can take several pathways. Shoot-tip and meristem-tip culture includes shoots develop from a small group of cells known as shoot apical meristem. The apical meristem maintains itself, gives rise to new tissues and organs, and communicates signals to the rest of the plant. Nodal or axillary bud culture consists of a piece of stem with axillary bud culture with or without a portion of shoot. When only the axillary bud is taken, it is designated as “axillary bud” culture. Cell suspension and callus cultures includes plant parts such as leaf discs, intercalary meristems, - stem-pieces, immature embryos, anthers, pollen, microspores and ovules have been cultured to initiate callus. A callus is a mass of unorganized cells, which in many cases, upon transfer to suitable medium, is capable of giving rise to shoot-buds and somatic embryos, which then form complete plants. Such calli on culture in liquid media on shakers are used for initiating cell suspensions. Callus gives rise to plantlets which needs to be hardened before directly grow into farmer’s fields. The delivery of the rooted and hardened small micro propagated plants to growers and market requires extra care. In some cases, plant losses can occur during shipment and handling by growers. The transfer of individual plants to soil in black plastic or polythene bags is widely used as a low-cost option to provide fully-grown banana plants directly to farmers in many developing countries. Low-cost tissue culture technology is the adoption of practices and use of equipment to reduce the unit cost of micropropagule and plant production.

Keywords: Tissue culture, Doubling income, Callus, Low cost technology.

Nutraceutical analysis in faba bean (*Vicia faba*) on variability and yield

S. K. Yadav*, H.L.Raiger, Ravi Kumar¹ and N.K. Jajoriya

ICAR-National Bureau of Plant Genetic Resources, Pusa Campus, New Delhi – 110012

¹Department of Plant Breeding, CCS HAU Hisar - 125004

ABSTRACT

Faba bean (*Vicia faba*) also known as broad bean is mainly grown in hills and northern plains for its protein rich pulse and green pods which are used as vegetable. It is an annual crop used both for human consumption and as well as live stock feed. Faba bean is grown in over 3 million hectares in the world with a total production is over 4.5 million tons. Efforts have been made to evaluate, characterize, conserve and catalogue the genetic resources of faba bean. Improvement for the seed and protein yields are receiving foremost attention in this crop. Hence there is a need to intensify efforts to search for appropriate donors for utilization in the specific breeding programmes. The crop should be beneficial for the farmers, producers and to the users. There is a need for development of high yielding nutritionally rich and should be free of anti nutritional factors such as tannin and phytate genotypes. In the present paper an attempt has been made to evaluate the genetic resources of a faba bean augmented recently to assess their potential use in varietal development programme for faba bean. Thirty five faba bean genotypes were assessed for nine agronomic and quality traits against three elite varieties HFB-2, HFB-1 and Vikrant in Augmented Block Design during Rabi 2018-19 and 2019-20 under the multilocation programme of AICRN on potential crops. There was significant difference among the blocks for pod length and 100 seed weight but no difference was observed

3rd International Conference on “Global Initiative in Agricultural, Forestry and Applied Sciences for Food Security, Environmental Safety and Sustainable Development (GIAFAS-2021)”

for days to flowering, days to maturity, plant height, number of pods per plant, number of seed per pod and yield per plant. Among germplasm line, ET218772 (33.81 g), ET218776 (30.78 g), ET218725 (28.69 g), ET218786 (28.29 g) showed highest seed yield per plant as compared to check variety Vikrant (27.62 g). The genotypes ET218768 (27.07%) had a higher protein content than the best check Vikrant (26.89%). The least antinutritional factor Vicine-convicine was found in ET218768 (0.52%).

Keywords: Quality, faba bean, Genetic Resources, Vicine-convicin

Variation in hematological parameters during gonadal maturity and breeding of snow trout (*Schizothorax richardsonii*)

Uzma Siddiqui^{1*}, Amrita Rani³, H.C.S Bisht¹ and Nityanand Pandey²

¹ D.S.B campus Kumaun University, Nainital Uttarakhand-263001

² ICAR-DCFR, Bhimtal, Uttarakhand- 263136

³ Faculty of Fishery Sciences, West Bengal University of Animal and Fisheries Sciences, Chakgaria, Kolkata-700094

ABSTRACT

Field study was focused to investigate comparative hematological changes in *Schizothorax richardsonii* in relation to reproductive activities. The values of RBC were significantly higher in both the sexes during the immature stage as compared with maturity phase. Female brooders reflect higher count of WBC in females during both the phases. However, no significant difference was observed in WBC count during immature and mature stage. MCV and MCH showed significant difference ($P < 0.05$) in both the phases of maturity. The values of MCH were at higher side in males during the maturity phase. Hematological values of Hct, TEC and MCHC were significantly higher in post spawning phase than the pre spawning phase. MCHC values of males are in higher side in males during pre spawning phase than the post spawning period, while higher values of MCHC observed in females during post spawning phase. Present study reveals that MCV is at higher side in female during pre spawning phase expressing that is due to lower Hct in females as MCV reflects the volume occupied by a single RBC. Present finding reflect the major factors responsible for the variation in hematological parameters during reproduction of fish.

Keywords: Hematology, spawning, *Schizothorax richardsonii*. pre spawning, post spawning

Response of different Methods of sowing and organic manures on growth and yield of Wheat (*Triticum aestivum* L.)

Bandi Gnana Prakash^{1*}, Joy Dawson², Thomas Abraham² and Mayur³

¹ Department of Agronomy, Naini Agriculture Institute, SHUATS, Prayagraj, Uttar Pradesh, 211007, India

² Department of Agronomy, Naini Agriculture Institute, SHUATS, Prayagraj, Uttar Pradesh, 211007, India

³ Department of Agronomy, Naini Agriculture Institute, SHUATS, Prayagraj, Uttar Pradesh. 211007, India

ABSTRACT

To study the retaliation performances of various methodologies of sowing by accompanying organic manures on growth, yield, and all other yield attributes of wheat (*Triticum aestivum* L.) crop. The goals of organic farm system include the maintenance of soil fertility, efficient usage of water, maximizing soil fertility, and improved animal welfare as well as environment aspects. A field experiment was executed during the *Rabi* season of 2020-21 at the crop research farm of SHUATS, Prayagraj to study the Response of different methods of sowing and organic manures on the growth and yield of wheat. The experiment was laid out in the most commonly encountered Randomized Block Design (RBD) with threereplications of each treatment for all traits. Given this experiment three methods of sowing, *i.e.* M1 (Broadcasting), M2 (Line sowing), M3 (System of Wheat Intensification) as well as three organic manures *i.e.* O1 (Farmyard manure 12 t/ha), O2 (Poultry manure 5 t/ha), O3 (Vermicompost 4 t/ha) and two liquid manures Panchagavya 3% and Jeevamrutha 500 l/ha. And the liquid manures were foliar sprayed at 15, 30, and 45 days after sowing (DAS). Results were revealed that the maximum number of tillers (10.53), Dry weight (18.00 g/plant), Effective tillers (10.43), Spike length (11.73 cm), and Grains per spike (58.38) were found to be significantly higher with the application of treatment SWI + Poultry manure (5 t/ha) + Panchagavya 3% FS + Jeevamrutha 500/h FS as compared to the other treatments. Maximum values were ensured with Plant height (78.30 cm), test weight (36.73 g), Grain yield (3.16 t/ha), Straw yield (4.48 t/ha), and harvest index (41.39 %). Hence with the current experiment's outputs, this study concluded that Line sowing + Poultry manure (5 t/ha) + Panchagavya 3% FS + Jeevamrutha 500 l/ha FS were produced more grains and productivity as compared to other organic treatment combinations.

Keywords: Sowing Methods, Organic farming and Yield.

Forest Fire Management in Uttarakhand

Rushil Kartikeya Srivastava and Moinuddin

School of Agricultural Sciences Shri Guru Ram Rai University- Dehradun (U.K) India

ABSTARCT

In India every year we witness the incidents of the forest fire in huge geographical area, forest fire is one of the major threats to the biodiversity and the wild life. As global warming is rising the increasing incidents of forests fire are increasing temperature of earth and climate change. Every year Uttarakhand faces the huge number of wildfire, after the forest fire there is a loss of vegetation cover, Forest fire on large scale cause air pollution and respiratory

3rd International Conference on “Global Initiative in Agricultural, Forestry and Applied Sciences for Food Security, Environmental Safety and Sustainable Development (GIAFAS-2021)”

diseases to human beings. Nowadays the forest fire could be detected by the remote sensor; we could see the images of the forest fire by the remote sensing satellite. Prevention of the forest fire includes use of the mechanical equipment to build fire breaks in plains to protect the eucalyptus plantations. These controls have proved effective in reducing fire losses and size of fire also provide the safety to fire crew to make initial attacks on approaching fire fronts . There are also some other methods like prescribed burning of roadside fuel loading, especially in highly fire prone locations. There are many impacts of forest fire like decrease in soil quality with alteration in composition, soil moisture and the fertility is also affected, forest can shrink in size, trees that survive in the forest fire remain stunted and the growth is also severally affected. There are also many importance of forest like mitigation and adaptation to the climate change, the forest act as the reservoir and source of carbon. The livelihood of several crores of people is dependent on the fuel wood, bamboo, raisins, fodder, pages and small timber. The new idea of the research network is in the Himalayan forest as well as Southeast Asian pine forest to track interacting disturbances and ecological and social implications. The lack of interest of public and community towards the preservation of forest has made the forest more vulnerable. The preservation and conservation is not possible without the community involvement and interest. For the Forest fire management we need to educate the public and aware the people by distributing of the banners, posters, stickers, by the local television and radio, by participating in the rallies school program.

Key Word: Biodiversity, Global warming, Environmental damage, Forest detection

Modern Concept of Organic Farming in India

Albin Pious and Moinuddin

School of Agricultural Sciences Shri Guru Ram Rai University- Dehradun (U.K) India

ABSTRACT

Organic farming is one of the most innovative farming systems that play a significant role in the global food and ecosystem security. Food quality and safety are the two important factors that have gained ever-increasing attention in general consumers. Conventionally grown foods have immense adverse health effects due to the presence of higher pesticide residue, more nitrate, heavy metals, hormones, antibiotic residue and genetically modified organisms. Organic is fundamentally different from conventional because of the use of carbon-based fertilizers compared with highly soluble synthetic based fertilizers and biological pest control instead of synthetic pesticides, organic farming and large-scale conventional farming are not entirely mutually exclusive. Organic agriculture relies on crop rotation, animal manures, crop residues, green manures and the biological control of pests and diseases to maintain soil health and productivity. Organic crops are often of higher value than conventional ones and the volume of organic crops shows a continually increasing production trend. Organic food is beneficial to human health and the practice of organic farming keeps the environment clean.

Keywords: Ecosystem Security, Food Quality, Food Safety and Food Security

Recycling: A Steps towards Sustainable Development

Neelam Saini¹, Saroj Yadav², Neelam M. Rose³ and Mona Verma⁴

Department of Textile and Apparel Designing, I.C. College of Home Science, CCS HAU, Hisar

ABSTRACT

Recycling technique makes magical use of old one as well as control in environment pollution. It will open a new view for shoddy industries owners to make products with weave combination designs. This diversification technique also enhances the aesthetic value of final products with low cost. The present study was conducted for diversification of used cloth into new product through recycling technique for its revival at Panipat and Hisar cities of Haryana State, India. Twenty shoddy industries were surveyed and effective information's were collecting regarding diversification of old clothes. Different recycled blended yarns were collected and screened on the basis of end product. One recycled blended yarn and fresh/ control yarn of different counts was selected on the basis of expert's opinion. A total of fourteen Gents jackets were developed i.e. two of fresh/ control yarn with selected yarns and twelve of selected recycled woollen blended yarns with different weave patterns. On the basis of experts' preferences the developed products were found best on various parameters, technique of reuse of old clothes, weave combination designing technique was most preferred techniques on the basis of overall appearance etc. and obtained weighted mean score above 2.33. This study will serve guidelines for a new designer to develop products from used clothes by using recycling techniques. Thus the diversification is very important tool in reducing environmental issues and provides useful products with good quality.

Keywords: Recycling, *jackets*, design, transformation

Bee vectoring technology the novel innovation to deliver organic pesticides to crops

Sakshi Saxena¹ and Rajendra Kumar²

¹College of Agriculture, RVSKVV, Gwalior, MP-474002

²MBDDSMKM, Siswali, Baran, Rajasthan-325006

ABSTRACT

Bee vectoring technology (BVT) advances sustainable animalistic, eco-friendly approach to pesticide application an economic and environmental breakthrough for the agricultural. This technology uses commercially reared bees to provide highly targeted pest and disease management solutions through biological control “It is a biological agent delivering a biological agent. Bee vectoring has launched a method of natural precision agriculture which substitutes chemical pesticides and spray application in plant protection products by supplying biological alternatives for crops using commercially grown bees. The inoculum dispenser system for vectoring bees is included in the commercial hives' lid. The dispensing mechanism is a movable tray providing a powdered form of inoculating crop control and a blend of chemicals permitting the product bees to carry the from their nests. When the bees contact the blossoms, each plant they reach deposits a small quantity of vectorite powder, as well as every minute the visit around 10 blooms. When compared to conventional chemical pesticides, bee vectoring precision is harmless to bees and allows minutes of natural pesticides or biologicals to directly transport to flowers, improving crop safety and production, and improving soil, microbiome, and environmental quality. Bee vectoring is an all-natural solution to farming systems. The advantage of the bee supply scheme is that farmers may enhance their agricultural output while reducing waste. Using bees to administer the biopesticide, chemicals are sprayed across their land. Furthermore, the fungicide used by BVT is organically produced and does not require water for use. The approach of BVT to agricultural production has permitted us to do our best to assist farmers grow crops accurately and profitably as possible, while conserving the environment and being good land stewards.

Keyword - Bee vectoring, biological agent, dispensing mechanism precision agriculture, pesticides

Comparison of Residual Effect of Different Sources of Zinc in terms of Apparent Recovery Efficiency in Rice-Maize Cropping System

Aswathy. S. Nair *G. Padmaja

Department of Soil Science and Agricultural Chemistry, Professor Jayashankar Telangana State Agricultural University (PJ TSAU), Hyderabad

Professor Jayashankar Telangana State Agricultural University (PJ TSAU), Hyderabad

ABSTARCT

Agrofortification of crops with zinc is a strategic way of enhancing zinc content in crops. It is reported that large quantities of soil applied zinc to the crop is left unused, so the information of residual effect of zinc fertilizers after a period of application is desirable. Two year field experiment was undertaken with aim to compare residual effect of different sources of zinc that applied to first year crop, rice on the second year crop, maize in rice maize cropping system in terms of apparent recovery efficiency. A field experiment was carried out at college farm, College of Agriculture, Rajendranagar, PJ TSAU. The sources used in the study were zinc sulphate (21% Zn) and zinc oxide (80% Zn), bio-Zn (6% Zn) and nano ZnO (3% Zn). Among the different sources of zinc used in study, bio-Zn and nano ZnO were nanoformulations. The experiment was laid out in randomized block design with 16 treatments and 3 replications. The soil application treatments for maize were T₁ (control), T₂ (RDF @ N: P₂O₅: K₂O @ 120:60:40 kg ha⁻¹), T₃ (RDF + residual effect of ZnSO₄ @ 25 kg ha⁻¹), T₄ (RDF + residual effect of ZnSO₄ @ 50 kg ha⁻¹), T₅ (RDF + residual effect of ZnO @ 6.25 kg ha⁻¹), T₆ (RDF + residual effect of nano ZnO as impregnated granules @ 10kg ha⁻¹), T₇ (RDF + residual effect of nano ZnO as impregnated granules @ 15 kg ha⁻¹), T₈ (RDF + residual effect of nano ZnO as impregnated granules @ 20 kg ha⁻¹), T₉ (RDF+ residual effect of bio-Zn @ 12.5 kg ha⁻¹), T₁₀ (RDF+ residual effect of bio-Zn @ 25kg ha⁻¹) and T₁₁ (RDF+ residual effect of bio-Zn @ 50 kg ha⁻¹). Apparent recovery efficiency of zinc in maize was calculated adopting standard procedures and statistical calculation. Apparent nutrient efficiency was calculated in maize based on residual zinc left over in soil after harvest of rice, zinc content, uptake and yield of maize crop. The apparent nutrient efficiency of soil application treatments T₃, T₄, T₅, T₆, T₇, T₈, T₉, T₁₀ and T₁₁ were 7.00 %, 3.00 %, 5.00 %, 18.00 %, 32.00 %, 5.00 %, 31.00 %, 33.00 % and 15.00 % respectively. The result clearly showed that among the soil treatments, highest apparent recovery efficiency in maize as a residual effect was recorded with soil application of nanozinc @ 15 kg ha⁻¹ (32.00 %) (T₇) followed by biozinc @ 12.5 kg ha⁻¹ (31.00 %) (T₉). It also noted that apparent recovery efficiency reported with nano ZnO and bio zinc was significantly higher than conventional sources of zinc such as ZnSO₄ and ZnO. The high residual recovery of nanoformulations suggests it's suitability in cropping system.

Key words: Apparent recovery efficiency, residual effect, nano ZnO, biozinc, ZnSO₄, ZnO

Assessment of carbon sequestration under different agroforestry species

M. D. Dhamde, Maya M. Raut, P. D. Raut, V. M. Ilorkar and S. S. Balpande

Department of Soil Science and Agricultural Chemistry, College of Agriculture, Nagpur (Dr. PDKV, Akola)

ABSTRACT

In order to assess the carbon sequestration under different agroforestry tree species, the different agroforestry plantation was selected. The soil samples were taken from 0-15 cm (surface) and 15-30 cm (sub-surface) depth from plantation of Maharukh (*Ailanthus excels*), Babhul (*Federbia albida*), Teak (*Tectona grandis*), Karanj (*Millettia pinnata*), Amla (*Phyllanthus emblica* L.), Sisoo (*Dalbergia Sisoo* L.) and one sample was taken from adjacent fallow land (control) for the comparison of the study from the Agroforestry farm and was analyzed for different physico-chemical properties, carbon fractions and carbon sequestration. The bulk density of soils varied from 1.27 to 1.45 Mg m⁻³ in surface soil and 1.36 to 1.49 Mg m⁻³ in sub-surface soil. Hydraulic conductivity of the soil ranges between 0.91 to 1.34 cm hr⁻¹ (surface) and 0.69 to 1.21 cm hr⁻¹ in (sub-surface). The soil pH was varied from 7.23 to 7.75 (surface) and 7.36 to 7.82 (sub-surface). Soil organic carbon highest in *Millettia pinnata* plantation and was found lowest in fallow land. It ranges from 4.83 to 11.93 g kg⁻¹ (surface) and 3.85 to 10.15 g kg⁻¹ (sub-surface). The free CaCO₃ content of all these soils was found moderately high to high calcareous in nature. The available N content ranges from 209.09 to 425.83 kg ha⁻¹ (surface) and 165.22 to 397.03 kg ha⁻¹ (sub-surface), low to medium in available P as it ranges from 12.11 to 19.80 kg ha⁻¹ (surface) and 10.57 to 18.65 kg ha⁻¹(sub-surface) and high to very high in available K as it ranges between 286.12 to 350.18 kg ha⁻¹ (surface) and 260.06 to 334.84 kg ha⁻¹ (sub-surface). The Readily oxidizable carbon (ROC), Cold water extractable carbon (CWOC), Hot water extractable carbon (HWOC), and Acid hydrolysable carbon (AHC) SOC fractions were highest in *Millettia pinnata* plantation and was found lowest in fallow land. The ROC ranges between 115.90 to 193.50 mg kg⁻¹ (surface) and 114.55 to 191.48 mg kg⁻¹ (sub-surface), CWOC ranges between 28.24 to 52.38 mg kg⁻¹ (surface) and 27.19 to 51.31 mg kg⁻¹ (sub-surface), HWOC ranges between 47.52 to 63.28 mg kg⁻¹ (surface) and 46.23 to 62.34 mg kg⁻¹ (sub-surface) and AHC ranges between 1509 to 3728 mg kg⁻¹ (surface) and 1203 to 3172 mg kg⁻¹ (sub-surface). The carbon stock in the soil ranges between 11.76 to 23.49 Mg ha⁻¹(surface) and 10.19 to 21.62 Mg ha⁻¹ (sub-surface), the soil carbon stock was highest in *Millettia pinnata* plantation amongst all plantations and was found lowest in fallow land.

Impact of fermentation on nutritional and anti-nutritional components of black soybean (*Glycine max* L.)

Divya Chauhan*, Krishan Kumar, Naseer Ahmed, Priyanka Thakur, Qurat-Ul-Eain-Hyder Rizvi,

Department of Food Technology, Dr. Khem Singh Gill Akal College of Agriculture, Eternal University, Baru Sahib, Sirmour, HP-173101, India

ABSTRACT

Food legumes play a vital role in human nutrition by providing sufficient protein, calories, minerals, and vitamins. Soybean is an important legume in terms of its high nutritional quality. Black-seeded soybean, locally known as

3rd International Conference on “Global Initiative in Agricultural, Forestry and Applied Sciences for Food Security, Environmental Safety and Sustainable Development (GIAFAS-2021)”

Bhatt, is grown throughout the Garhwal and Kumaun hills of India as a pulse crop. On the other hand, the soybean seed coat contains numerous bioactive compounds having radical scavenging, anti-tumor, and anti-carcinogenic activities. The objective of this study was to assess the effect of fermentation on nutritional, anti-nutritional, and bioactive components such as phenolic contents, anthocyanin contents, and antioxidant activity of black soybean. The fermentation of grains was done by coarse grinding of black soybean grain and allowing them to ferment for 12, 24, and 36 hours in an incubator at 37°C. The results revealed that there was a significant ($p \leq 0.05$) change in nutritional as well as bioactive components of the black soybean. There was a 22.13%, 8.96%, and 10.14% increase in protein contents, total phenolic components, and antioxidant activity of fermented flour, respectively. The anthocyanin content decreased significantly ($p \leq 0.05$) by 4.15% during the fermentation process. But anti-nutritional components such as phytic and tannin content decreased significantly ($p \leq 0.05$) to the extent of 51.06% and 75%, respectively. Also, there was a decrease in fat, fiber, and carbohydrate contents that might be due to increased enzymatic activity in grain resulting in hydrolysis of these nutrients. Therefore, it can be concluded that there was an increase in bioactive as well as nutritional characteristics and a decrease in anti-nutritional components of black soybean during fermentation.

Keywords: Fermentation, Black soybean, Proteins, Anthocyanin, Anti-nutrients

Role of Rural Women in Entrepreneurship

Neelam Kumari¹ and Pankaj Yadav²

¹ *Department of Extension Education, Chaudhary Charan Singh Haryana Agricultural University, Hisar (Haryana)-125004*

² *Maharana Pratap Horticultural University Karnal (Haryana)*

ABSTRACT

The Government of India recognizes the role of women entrepreneurs in economic development; but still, sufficient steps have to be taken to promote women entrepreneurship. Some of the problems faced by women entrepreneurs include lack of family support, lack of self-confidence and willpower, fear of making mistakes, unable to make a fine balance between the business and family, inadequate infrastructural facilities, low needs of enterprise, high cost of production and the poor attitude of general public towards the women modern business outlook. It is found that women are likely to start their business more than 10 years later than men. It is evident that this delay is due to various constraints like tight schedule of family responsibility as homemaker; the importance of motherhood, improper management experience in business enterprise. It is suggested that resurgence of entrepreneurship is the need of the hour to disseminate awareness programmes among women population to involve them in enterprise field. More so, women need to be facilitated to realize their strengths, to occupy significant status in the society and to provide their active contribution in industry and in the development of economy as well. A series of encouragement need to be provided to women who are technically sound and professionally qualified for venturing into entrepreneurship. For this purpose, they can be supported with increasing amount of loan with subsidy.

Keywords: Entrepreneurs, Economic aspect, Women and Development

**Organic Farming: A Way to Residue Free Agriculture
Dangi Pooja Arun¹ and Neelam Kumari² and Dharmender Singh³**

- ¹ , Department of Extension Education, Chaudhary Charan Singh Haryana Agricultural University, Hisar
- ² Department of Extension Education, Chaudhary Charan Singh Haryana Agricultural University, Hisar.
- ³ Department of Extension Education, Chaudhary Charan Singh Haryana Agricultural University, Hisar.

ABSTRACT

There has been a rise in consumer’s demand for safe and healthy food due to increasing concerns over the quality of food, contamination due to chemicals, serious health hazards and environmental issues. This increasing demand has given way to a new stream of agriculture, popularly known as Organic Agriculture. Organic farming is a production system which avoids or largely excludes the use of synthetic compounds like fertilizers, pesticides, weedicides and livestock feed additives. It is based on crop rotations, legumes, inter-cropping, green manures, farm organic wastes and bio-fertilizers, biological methods of pest, disease and weed control. This paper attempts to bring together different issues in the light of recent developments in organic Farming in the state of Uttarakhand with special emphasis on the working issues of Uttarakhand Organic Commodity Board. It also reviewed the scenario of Uttarakhand Organic Commodity Board with reference to organic farming through critical analysis of available secondary data.

Keyword: (Organic Farming, Recycling, Crop Management, Uttarakhand Organic Commodity Board)

**Climate Change Impact and its Consequences on Society and Environment
Neelam Kumari¹, Dangi Pooja Arun² and Naaz Bano³**

^{1&2}Department of Extension Education, Chaudhary Charan Singh Haryana Agricultural University, Hisar (Haryana)- 125004

³ Chaudhary Charan Singh Haryana Agricultural University Hisar (Haryana)-125004

ABSTRACT

Climate change will exacerbate the adverse impacts of the unsustainable resources' utilization. Fresh water and other natural resources were under constant threat from pollution and depletion due to unsustainable consumptions. Higher temperatures, intense floods, severe droughts, sea level rise, cyclones, hurricanes, glacier retreat, and spread of climate-sensitive diseases were the consequences of climate change. Impact of climate change on a region depends on its geography, landscape diversity and characteristics, its interaction with global ocean-atmosphere events. Impact of climate change was disproportionately felt by rural and urban poor population. They experience degraded land productivity, contaminated water/air, poor hygienic conditions, compromised food safety/security, and reduced employment opportunities—impacts were rarely gender-neutral ([World Bank, 2009](#)). Women and children were impacted more than men, accentuating the prevailing gender bias in many developing countries. Climate change solutions were difficult as many regions and countries share watersheds, river basins and aquifers. It was difficult to assign culpability for climate change when the origin of the causes was uncertain.

Keywords: Climate Change, Economic aspect, Environmental aspect, Impact and Social aspect

Agricultural e-commerce framework for India

Dr. Anamika Tiwari^{*1} and Mrs. Shubhda Pandey²

¹ *Department of Commerce GGU, Bilaspur, Chhattisgarh.495001*

² *Department of Commerce GGU, Bilaspur, Chhattisgarh.495001*

ABSTRACT

This study aims to prioritize an inclusive commercial framework that serves as a catalyst for the development and improvement of the agricultural sector in rural India; which plays a major role in the social and economic development of rural livelihoods as well as food security and poverty reduction. The main method used was to carefully review and understand the policies of the National Informatics Center (NIC) and the Department of Agriculture. In general, these policies emphasize the promotion of IT-based information kiosks, the establishment of gyan activists (Information Centers) in the valleys, the creation of an Agri-India information portal. Next, the challenges and information gaps were identified and interpreted in the form of an e-commerce system that could be used to build an e-commerce system.

Keywords - e-commerce framework, e-commerce application, netizens, rural agriculture sector

Farmers’ Perception about Climate Change: A prerequisite for appropriate adaptation measures at farm level

Neha¹ and Mohammad Aslam Ansari²

Department of Agricultural Communication, College of Agriculture, GBPUA&T, Pantnagar, Uttarakhand, India

ABSTRACT

Global climate is changing and appear to be more complicated for developing countries. India has been recognized as one of the most vulnerable developing countries towards climate change risks, especially for small and marginal farmers because of their poor level of adaptive capacity. Therefore, the understanding of location-specific drivers of farmers’ perception and their adaptive behavior provides better insight to design appropriate policy measures to address the challenges of sustainable agricultural production and food safety. Perception about climate change is a complex process that constitutes a range of psychological constructs such as knowledge, beliefs, attitudes and concerns about if and how the climate is changing ([Whitmarsh and Capstick, 2018](#)). Perception of farmers is shaped by individual’s characteristics, their experience, type of information they receive, and their cultural & geographical context where they live and work. In addition, decision to adopt a new technology or practice is a cognitive process; and loss aversion, and hyperbolic discounting can lead to suboptimal levels of adoption. The perception of farmers may be about weather related parameters such as increasing temperature, unpredictable or erratic rainfall, drought, precipitation, and changes in winter duration, etc. In many studies researchers found some factors such as access to information, forecasting about weather and climate changes, farming experience, income, age, education, training received, decision making ability etc. Such perception of farmers on various aspects of climate change is also crucial not only to gear towards timely preparedness but also for effective adaptation strategies (short run initiatives) and mitigation strategies (long run initiatives) to cope up with climate change. Adaptation to climate change does not only require what individuals perceive that something is changing or could change, but also they need to comprehend this perception, to be willing to take action and must try to do something about it. In addition, the

perception of farmers about that the climate is changing can be seen as a pre-condition for the adoption of adaptation measures. Further, the successful implementation of public policies should be aimed towards the promotion of adaptation strategies with the active cooperation and participation of the intended beneficiaries. If their perception about the consequences or effects or immediacy of climate change is different from the policy makers, then it is likely that the implementation of such policy will fail to achieve the desired outcomes.

Keywords: Climate change, farmers’ perception, and adaptation strategies.

Performance Evaluation of Power Operated Paddy Seeder for Dry and Wet Seeding

U.K.Dhruw¹, D.K. Roy² and A.K.Verma³

¹College of Agriculture & Research Station, IGKV, Bemetara (CG)

²College of Agriculture & Research Station, IGKV, Kawardha (CG)

³Faculty of Agriculture Engineering, IGKV, Raipur (CG)

ABSTRACT

Rice is the most important staple food crop for over two-thirds of the population in India. It is a means of livelihood for millions of rural households and it plays a vital role in our national food security, hence the slogan “Rice is life” is most appropriate. Manual transplanting is a labour-consuming operation which requires approximately 25 % of the total labour requirement of the crop. The human stress and drudgery involved in transplanting operation is also very high. There is no single machine available for direct seeding of rice in both dry and wet condition. A eight row power operated paddy seeder for dry and wet seeding was developed at FAE, IGKV Raipur. Thus, the power operated paddy seeder was designed on the basis of agronomical crop condition, physical and engineering parameters of paddy seed *viz.* length, width, thickness, bulk density, angle of repose, geometric mean diameter. The performance evaluation of a power operated paddy seeder was done with the pre-germinated paddy seed and dry seed under laboratory and field test. In lab condition calibration of power seeder was done to estimate seed rate, to test germination percentage of seed, sprout length. The performance parameters *i.e.* miss index, multiple index, seed rate, seed spacing, number of seed drop, field capacity, field efficiency and fuel consumption was observed from field evaluation of designed power operated paddy seeder. Speed reduction for driving wheel and metering unit from the engine was done using different sets of reduction unit.

The experiment was laid out RBD for comparison of different incubation periods of pre-germinated seed 12 h, 24 h, 36 h and 48 h of paddy seed, grain yield, straw yield, plant height, panicle length and the number of tillers. The plant germination of dry paddy seed was observed as 61.2% and the pre- germination test of paddy seed with incubation period from 12h, 24h, 36h, 48h after 24h soaking was obtained as 62.7%, 67.2%, 79.3% and 74.2% respectively. The diameter of cup of the metering device was 12 mm and overall diameter of metering device was 485 mm. The bulk density of paddy seed increased slightly with the soaking. The average bulk density of MTU-1010 was found to be in the range of 0.6 -0.7 g/cc. The average number of seeds dropped per hill was 4 seeds at 2/3rd of pickup chamber filling in dry seeding and 2 seeds at germination condition of 24h soaking with 36h of incubation period. The average spacing was closed to the theoretical spacing of 15 cm with 6 numbers of cups in metering unit. Miss index

3rd International Conference on “Global Initiative in Agricultural, Forestry and Applied Sciences for Food Security, Environmental Safety and Sustainable Development (GIAFAS-2021)”

was highest (7.6 %) in 24h soaked with 36h incubation period and lowest in case of dry seeding i.e. 2.2 %. Multiple index was found highest for dry seeding (T1) against pre-germination seed with 8 cups in metering mechanism i.e. 8.9 % and lowest value 2.2% in 4 cups with dry seeding. Engine of paddy seeder 2.9 kW (4 hp) revolves at speed of 2600 rpm which reduces as 90 rpm to the metering shaft and 21 rpm to the driving wheel through reduction unit. The fuel consumption varied between 2.57 to 2.83 l/ha with an average of 2.68 l/ha in dry seeding condition and 2.78 to 2.98 l/ha with an average of 2.83 l/ha in wet condition. The actual average seed rate was found to be 11.60 kg/ha, 17.81 kg/ha and 22.03 kg/ha in four cups, six cups and eight cups respectively. The field efficiency of paddy seeder in dry condition was 77.67 % and in wet condition it is 71.88 %. Based upon the result it was concluded that farmers are able to grow rice if they fail to direct dry sowing due to continuous rains comes and saves the cost of operation of sowing of paddy from power operated paddy seeder it was Rs.1043.32/ha which is 7.83 times less than from manual transplanting of rice and 2.3 times less than from mechanical rice transplanter.

Correlation and Path co-efficient Studies in three diverse species of sesame under mid hill Condition of North West Himalayas

^{1*}Ritika Singh and ²Neha Banta

¹ School of Agriculture, Abhilashi University, ChailChowk, Mandi-175028 H.P, India

²Department of Chemistry and Biochemistry, College of Basic Sciences, Chaudhary Sarvan Kumar Himachal Pradesh Krishi Vishwavidyalaya Palampur-176062, H.P, India

ABSTRACT

In the present investigation nature and magnitude of association in twelve yield and yield attributing traits in three diverse species (*Sesamum indicum*, *S. mulayanum* and *S. radiatum*) of sesame along with their twenty three intra and interspecific hybrids were analyzed. The experimental was carried out at the farm area of Department of Crop Improvement CSKHPKV, Palampur during *kharif*, 2013. Analysis of variance indicated the existence of significant genotypic differences among the genotypes. Correlation studies indicated the presence of higher magnitude of genotypic correlation than their corresponding phenotypic correlation coefficients for most of the characters studied indicating the inherent association among the various characters. Seed yield per plant exhibited positive and significant correlation with branches per plant, number of capsules per plant and harvest index, these traits could be utilized in indirect selection so as to improve the seed yield per plant and harvest index could be used as best selection parameter. Negative significant correlation of seed yield per plant was observed with biological yield per plant. Path coefficient analysis revealed that the highest positive direct effect on seed yield per plant was contributed by harvest index followed by biological yield per plant while the direct effects of remaining traits on seed yield per plant were observed to be low.

Keywords: *Sesamum indicum*, *S. mulayanum*, *S. radiatum*, hybrids, correlation and Path coefficients

Nutritional Quality and Health Benefits of Vegetables: A Review

Madan Kumar Jha

RHEO, DEPARTMENT OF HORTICULTURE C.G. GOVERNMENT

ABSTRACT

Vegetables are considered important in nutrition as they provide vitamins, minerals, dietary fiber, and phytochemicals. Each vegetable group contains a unique combination with a number of these phytonutrients, which distinguish them from other groups and vegetables in their group. In the daily diet vegetables are closely linked to improved intestinal health, better vision, and reduced risk of heart disease, stroke, chronic diseases such as diabetes, and other types of cancer. Some herbal phytochemicals are strong antioxidants and are thought to reduce the risk of chronic disease by preventing free radical damage, by altering metabolic function and detoxification of carcinogens, or even by influencing processes that alter the course of tumor cells. All vegetables can provide protection against people from chronic diseases. Nutrition is a major and quality problem, and vegetables in all its forms ensure an adequate supply of many vitamins and minerals, dietary fiber, and phytochemicals that can provide much-needed balance back to a healthy diet. The promotion of healthy vegetable products is geared towards a growing consumer who is interested in the healthy functioning of food. Because each vegetable has a unique combination of phytonutrients, a wide variety of vegetables should be eaten to ensure that each individual's diet includes a combination of phytonutrients and all the health benefits. This article reviews and discusses the quality of healthy food and the health benefits of large vegetable groups. More complex work is needed involving nutritionists and nutritionists as well as others from the medical field in order to discover the true function of certain phytonutrients.

Keywords: Antioxidants; Dietary Fiber; Horticulture; Phytochemicals; Phytonutrients

Transcript-level differential candidate gene expression analysis & Characterization of Physiological Responses among Minor millets & rice (*Oryza sativa L.*) under water stress.

Pooja Kathare

ABSTRACT

Millet is a *Healthy food*, mainly due to the lack of gluten in their grain, also known as “*Orphan crop*”, “*food for the poor*” (Sharma and Khurana, 2014). Rice is the staple food crop & Second largest crop in the world with *High Drought Sensitivity Index* (Karl, 1983). The plants abscond from expressing its full potential to give maximum yield due to biotic and abiotic stresses such as diseases, water stress, etc. Among these water stress is major one, as it occurs severely in major producing areas of the world. The current study was taken to identify some important genes that would be responsible for water stress tolerant traits, in the selected fifteen, diverse genotypes of Little millet, Barnyard millet and Rice at vegetative stage before panicle initiation. Biochemical traits (Leaf proline, protein, carbohydrates, chlorophyll a, b and total) was determined under control and stress condition. These findings were found to be in correlation with a set of known water stress responsive genes which were selected for expression analysis using semi-quantitative RT-PCR. Expression analysis of these water stress responsive gene orthologs (EcNAC 67 A, SiNAC 29L, OsNAC 29, TaNAC 4, CDPK, U2-SnRNP, Synaptotagmi) had given a differential

3rd International Conference on “Global Initiative in Agricultural, Forestry and Applied Sciences for Food Security, Environmental Safety and Sustainable Development (GIAFAS-2021)”

expressions under water stress as compared to controlled traits. Among the three crops selected for our study, Little millet genotype, RLM-37 and Rice genotype, R-RF-127 were found to be tolerant ones in the morphological, physiological, biochemical and molecular aspects. MTU-1010 was found to be susceptible one in most of the aspects. Majority of genes were up regulated under water stress in Millets and Rice.

Biochemical composition of pulse crops indigenous to different zones of North India

***¹Neha Banta, ²Ritika Singh and ³K. Mohini**

^{1,3}*Department of Chemistry and Biochemistry, College of Basic Sciences, Chaudhary Sarvan Kumar Himachal Pradesh Krishi Vishvavidyalaya Palampur-176062, H.P, India*

², *School of Agriculture, Abhilashi University, Chailchowk, Mandi-175028, H.P, India*

ABSTRACT

The study was conducted to evaluate the biochemical composition of pulse genotypes which are of great nutritional values namely horse gram (*Macrotyloma uniflorum* L.), moth bean (*Vigna aconitifolia* L.) and kidney bean (*Phaseolus vulgaris* L.). The mature seeds of four potentially superior genotypes of horse gram (Arki, HPKV-4, Mandi, Pahra); moth bean (Jadia, Jawala, Maru moth, PLMO-55) and kidney bean (Barot, Baspa, Kanchan, Triloki) were evaluated for proximate composition, total tannins, condensed tannins, saponin content, mineral content and *in vitro* protein digestibility using standard methods. The range varied from (6.85 to 17.28 %) for moisture, crude protein (16.63 to 27.71%), fat (1.13 to 3.09 %), ash (3.32 to 4.31 %), crude fibre (1.88 to 5.42%), carbohydrate (46.48 to 63.49%), total sugars (4.3 to 6.6%), *in vitro* protein digestibility (62.75 to 75.30%), total tannins (382.67 to 662.67 mg/100g), condensed tannins (77.88 to 552.39 mg/100g), saponin content (922.22 to 1322.22 mg/100g), potassium (692.38 to 1061.25 mg/100g), calcium (157.25 to 385.25 mg/100g), magnesium (102.10 to 247.60 mg/100g), sodium (6.50 to 20.63 mg/100g), iron (5.12 to 12.64 mg/100g), copper (0.47 to 2.01 mg/100g), manganese (0.60 to 1.84 mg/100g) and zinc (2.31 to 6.98 mg/100g) content. The results showed that pulse samples vary significantly in the biochemical parameters evaluated. Kidney bean had significantly higher protein, fat and ash content and also showed superiority in mineral composition than the other pulses. Varietal grading of genotypes was done with regard to desirable quality attributes *viz.* crude protein, fat, ash, fibre, carbohydrate, *in vitro* protein digestibility (in descending order) and anti-nutritional factor-total tannin content (in ascending order) taken together. The best genotype in each crop was identified *i.e.* Mandi in horsegram, Kanchan in kidney bean and Jadia in moth bean which could further be used for crop improvement programmes.

Keywords: proximate composition, crude protein, minerals, *in vitro* protein digestibility, pulses

Safe Methods for Weed Control in Vegetable Crops: Challenges, and Opportunities: Review

Smt. Shilpa Kaushik¹, Dr. Amit Shukla² and Madan Kumar Jha³

KVK, BILASPUR, (C.G.)

RHEO, DEPARTMENT OF HORTICULTURE (C.G.)

ABSTRACT

Weed management is an important component in vegetables crop production. The current review is (1) a meta analyses of the literature on the yield losses of vegetables crops by weeds, (2) it comprises the databases of weed

3rd International Conference on “Global Initiative in Agricultural, Forestry and Applied Sciences for Food Security, Environmental Safety and Sustainable Development (GIAFAS-2021)”

species and density, the period of weed competition, safe weed management in the vegetables crops in terms of adverse effects of weeds on the soil, growth, nutrient statutes and productivity of vegetables trees, advantages and disadvantages of weed control measures, and (3) it excluded the cover crops, biological weed control, natural herbicides and non-traditional weed control methods as well as small vegetables crops such as tomato, chilli, brinjal and cole crops. The ranges of yield losses in vegetables crops due to weeds observed from the literature were varied widely from 23.7% to 82% and in some instances of weed infestation there production of fruits with commercial value obtained. The yield loss depends on weed its density and fruit crop species. So, weed management in vegetables crops is necessary to prevent or reduce yield losses and the search for more effective and environmentally friendly approaches for weed control will be needed. A combined approach could result in an effective weed control technology.

Keywords: cultivar, inter cropping, mulch, poly culture, organic farming, yield loss

Work place and Occupational Health Studies of Sugar Cane Industry

Yamini Tekam, AK Shrivastava, DK Rai, AK Dave

Department of Farm Machinery and Power Engineering, Faculty of Agricultural Engineering, Indira Gandhi Krishi Vishwavidyalaya Raipur, Chhattisgarh.

ABSTRACT

Sugarcane is an important cash or profit crop in the country. India is the second largest producer of sugar in the world after Brazil and is also the largest consumer. Chhattisgarh is making every possible effort to promote the agriculture-based industries in the state in a bid to improve the economic condition of the farmers. The annual yield of sugarcane across Chhattisgarh in India amounted to over 40 thousand kilograms per hectare in recent year. The present study deals with the measurement of workplace parameters like noise, vibration, illumination, air pollution and risk assessment in selected sugar industries in Kabirdham district of Chhattisgarh. Over 10,000 farmers in the region are stock-holders in this factory. About 100 agro industrial workers of five randomly selected sugar industries were selected. Workers in such industries face work-related health problems and prone to sever diseases. This paper focused on assessment of workplace and occupational health problems in the sugar industry of Kabirdham district of Chhattisgarh. It observed that sugar cane workers were exposed to high level of occupational accidents and toxicity of pesticides. The legal frameworks for their protection were often inadequate. Thus, increased risk of lung cancer, possibly mesothelioma exists due to burning foliage at the time of cane-cutting. Bagassosis was also found observed to be major reason for chronic infections which reduce their working productivity. In conclusion, improvisation of workplace and use of safety kits expected to reduce the work related disorder for betterment of working society.

Keywords: Occupational health, Sugar Industry, Industrial workers, workplace, Safety, Chhattisgarh

Enzyme activities during rice straw decomposition under inoculation of lingo-cellulolytic microbial consortia in vertisol

Swarnima Shrivastava^{1*}, S.K.Verma¹, A.K. Patra²and M.C. Manna²

¹*Department of Soil Science and Agricultural Chemistry, RVSKVV, Gwalior-474002*

²*Indian Institute of Soil Science, Bhopal-462038*

ABSTRACT

The ligno-cellulolytic fungal, bacterial and actinomycetes isolates, of the genera *Aspergillus spp*, *Bacillus spp.* and *Streptomyces spp.*, were used as microbial consortia in combination with paddy straw for decomposition in the vertisols in pot experiment. Results demonstrated that decomposition of paddy straw with *Aspergillus spp.* + *Bacillus spp.* + *Streptomyces spp.* under aerobic conditions accelerated the straw decomposition process as

3rd International Conference on “Global Initiative in Agricultural, Forestry and Applied Sciences for Food Security, Environmental Safety and Sustainable Development (GIAFAS-2021)”

compared to controls. Decomposition of paddy straw in conjunction with microbial consortia of *Aspergillus spp.* + *Bacillus spp.* + *Streptomyces spp.* resulted in maximum dehydrogenase activities ($16.72 \mu\text{gTPF100 g}^{-1} \text{hr}^{-1}$). Dehydrogenase enzymes are the parts of microbial metabolic substance which provide early information on changes in soil quality. The highest activities of acid phosphatase ($30.58 \mu\text{g PNP g}^{-1} \text{hr}^{-1}$) and alkaline phosphatase enzymes ($135.89 \mu\text{g PNP g}^{-1} \text{hr}^{-1}$) was achieved in treatment receiving paddy straw with *Aspergillus spp.* + *Bacillus spp.* + *Streptomyces spp.* consortia augmentation. Combined application of microbial consortia with paddy straw may represent a rapid and environment friendly decomposition and disposal approach of straw.

Key Words: Ligno-cellulose, rice straw, dehydrogenase activities, *Aspergillus spp.*, *Bacillus spp.*, *Streptomyces spp.*

Kisan Call Centre: A New Vista for Indian Agricultural Extension System

.D.K.Shrivastava and Mr. Madan Kumar Jha

IGKV, Raipur, C.G.

RHEO Department of Horticulture, Chhattisgarh.

ABSTRACT

Given its range of agro-ecological setting and producers, Indian Agriculture is faced with a great diversity of needs, opportunities and prospects. The well endowed irrigated areas which account for 37 percent of the country's cultivated land currently contribute about 55 percent of agricultural production, whereas, rain fed agriculture which covers 63 percent accounts for only 45 percent of agricultural production. In these less favorable areas, yields are not only low but also highly unstable and technology transfer gaps are much wider as compared to those in irrigated areas. If it is to respond successfully to these challenges, greater attention will have to be paid to information-based technologies. Strengthened means of dissemination will be needed to transmit this information to farmers. Both technology generation and transfer will have to focus more strongly than ever before on the themes of optimization in the management of their available resources by producers, sustainability, coping with diversity by adapting technology more specifically to agro-ecological or social circumstances and raising the economic efficiency of agriculture. To make information transfer more effective, greater use will need to be made of modern information technology and communication among researchers, extension workers and farmers.

Keywords: Information needs, Kisan call centres, Indian agriculture.

Health Benefits of Uses and Applications of *Moringa oleifera* in Bakery Products

Dr.Nivedita Pathak

SMS, KVK, Bilaspur (C.G.)

ABSTRACT

Moringa oleifera belongs to the Moringaceae family and is the best known of the native *Moringa oleifera* genus. For centuries, it has been used as a system of Ayurvedic and Unani medicine and has a wide range of nutritional and bio active compounds, including proteins, essential amino acids, carbohydrates, lipids, fibre, vitamins, minerals, phenolic compounds, phytosterols and others. These characteristics allow it to have pharmacological properties,

3rd International Conference on “Global Initiative in Agricultural, Forestry and Applied Sciences for Food Security, Environmental Safety and Sustainable Development (GIAFAS-2021)”

including anti-diabetic, antiinflammatory, anti carcinogenic, antioxidant, cardio protective, antimicrobial and hepato protective properties. The entire Moringa oleifera plant is edible, including its flflowers, however, it is not entirely safe, because of compounds that have been found mainly in the root and bark, so the leaf was identified as the safest. Moringa oleifera is recognised as an excellent source of phytochemicals, with potential applications in functional and medicinal food preparations due to its nutritional and medicinal properties; many authors have experimented with incorporating it mainly in biscuits, cakes, brownies, meats, juices and sandwiches. The results are fascinating, as the products increase their nutritional value; however, the concentrations cannot be high, as this affects the organoleptic characteristics of the supplemented products. The aim of this study is to review the application of Moringa oleifera in bakery products, which will allow the creation of new products that improve their nutritional and functional value.

Keywords: Moringa; natural preservatives; bakery products; functional food

A Review on Significance of Pollination Services

Ranjeet Kumar, Himani Saini and Sangeeta Verma

Himalayan Forest Research Institute, Panthaghathi, Shimla, H.P., India-171013

ABSTRACT

The life of the human beings is improved and sustained by ecosystem services provided by the nature. The provisioning, regulating, cultural and supporting services are four categories of ecosystem services. Pollination services is one of important ecosystem services and can fit in all the categories of services. Food, cloth and house for shelter are important essential elements for survival and pollination has direct and indirect role with these three things. However food is one of the most important provisioning service. Pollination has direct linkage with productivity. Pollination is also important regulating services by helping in plant reproduction and maintaining the health of ecosystem and diversity of the plants. Plants help in purifying water and air and also can be indirectly linked with soil erosion. Pollinators are also linked with cultural symbolism.

The review of literature also revealed that the global economic value of crop pollination services ranged from US\$195 to US\$387 billion adjusted according to inflation of March 2020. A study in India found that 40% of 139 NWFP species which are important for livelihood of people is directly benefitted from biotic pollination. The pollinations increase the productivity of the area where agriculture and forest landscapes are adjoined with each other so pollination services provide cultural, financial, ecological, health and social values.

Key words: Ecosystem services, pollination, forests, agriculture and productivity.

Review Paper on the Role of Somatic Hybridization in Crop Improvement

Sadhana Saha

Department of Genetics and Plant Breeding

ABSTRACT

Genetic diversity within the breed has been used extensively by farmers in their efforts to improve crops. However, the existing genetic diversity may not be sufficient for modern plant breeding purposes, so great efforts have been

3rd International Conference on “Global Initiative in Agricultural, Forestry and Applied Sciences for Food Security, Environmental Safety and Sustainable Development (GIAFAS-2021)”

made to expand the existing genetic environment. The introduction of new traits is largely based on sexual interactions between different genotypes within or between highly related species. However, due to the presence of various reproductive barriers, genetic transfer is limited to the sexually active species, thereby reducing the chances of genetically modified and improved genetic material. Many desirable and desirable aspects of agriculture can be found only in the most closely related species or in the unrelated species. As they make up the genetic code, great effort has been made to identify and differentiate these genes and to transfer them to plants. With the rapid development of somatic cell genetics, methods are now in place to transfer genes to the sexual boundaries and beyond long distances of taxes. In addition to the importance of anonymous genetic transfer, somatic hybridization is a tool for modifying and improving polygenic properties. In addition, organellar genetic modification is possible through somatic hybridization because a mixture of two fusion partners is found in hybrid cell Production of hybrid plants by combining protoplasts with two different plant species / species called Somatic Hybridization, and the offspring is called Somatic Hybrids . Therefore, somatic mixing can only be used when the following two methods are satisfied: i) Protoplast mass fragmentation, and ii) Totipotency of individual protoplasts. In general, Somatic integration is an important tool for plant breeding and crop improvement through the production of direct and medium hybrids. It is important for asexual, sterile and beneficial plants that are not compatible with other plants.

Keywords: hybrid, hybridization, somatic

Methods for Weed Control in Vegetable Crops: Challenges, and Opportunities: Review

Vandana Ekka and Madan Kumar Jha

RHEO, DEPARTMENT OF HORTICULTURE (C.G.)

ABSTRACT

Weed management is an important component in vegetables crop production. The current review is (1) a meta analyses of the literature on the yield losses of vegetables crops by weeds, (2) it comprises the databases of weed species and density, the period of weed competition, safe weed management in the vegetables crops in terms of adverse effects of weeds on the soil, growth, nutrient statutes and productivity of vegetables trees, advantages and disadvantages of weed control measures, and (3) it excluded the cover crops, biological weed control, natural herbicides and non-traditional weed control methods as well as small vegetables crops such as tomato, chilli, brinjal and cole crops. The ranges of yield losses in vegetables crops due to weeds observed from the literature were varied widely from 23.7% to 82% and in some instances of weed infestation there production of fruits with commercial value obtained. The yield loss depends on weed its density and fruit crop species. So, weed management in vegetables crops is necessary to prevent or reduce yield losses and the search for more effective and environmentally friendly approaches for weed control will be needed. Acombined approach could result in an effective weed control technology.

Keywords: cultivar, inter cropping, mulch, poly culture, organic farming, yield loss.

Performance Evaluation of Different Seed Bed Configurations in Chickpea Cultivation in Mandsaur district of Madhya Pradesh

Rajesh Gupta^{1*}, A.L., Basediya² and Ajeet Sarathe³

¹ CAE, JNKVV, Jabalpur (M.P.)

² RVSKVV, KVK, Shivpuri (M.P.)

³ Department of Agril. Engg., AKS University, Satna (M.P.)

ABSTRACT

The field trials were conducted during the three consecutive years Rabi 2018-19, Rabi 2019-20 and Rabi 2020-21 at farmer's field in the adopted villages of Krishi Vigyan Kendra, Mandsaur, Madhya Pradesh to assess the effect of different seed bed configurations on growth characters and yield of chickpea crop. The experiment consists of three seed bed configurations i.e., flat bed sowing by conventional seed drill (T1), broad bed sowing by broad bed furrow seed drill (T2) and raised bed sowing by furrow irrigated raised bed seed drill (T3) with ten replications. The treatment T3 was found significantly superior in terms of nodulation (nodules per plant), number of pods/plant, grain yield, straw yield and biological yield as compared to treatments T1 and T2. The grain yield was found significantly higher in treatment T3 (19.24 q/ha) followed by treatment T2 (16.85 q/ha) and treatment T1 (14.08 q/ha). The treatment T3 was found most economical with highest B:C ratio of 2.21 as compared to lower B:C ratio of 1.96 and 1.69 for treatment T2 and T1 respectively. The results of the study indicated that the cultivation of chickpea on furrow irrigated raised bed is economically feasible.

Keywords – Chickpea, BBF, FIRB, Grain yield, B:C ratio

Ethylene supplementation protect photosynthetic performance from salt toxicity by through increased nitrogen and sulfur assimilation and modulating defense system in mustard

Badar Jahan*, Nafees A. Khan

Plant Physiology and Biochemistry Laboratory, Department of Botany, Aligarh Muslim University, Aligarh-202002, India

ABSTRACT

Salt stress is one of the major constraints in agriculture which affects plant growth and productivity. The high concentration of salt in soil causes ionic imbalance leading to osmotic stress and subsequently oxidative damage to lipids, protein and nucleic acid in the plant cell through increased reactive oxygen species (ROS) production. Plants induce certain resistance mechanisms to avoid oxidative damage caused by salinity. Ethylene (ETH) is a well-known plant growth regulator, which acts as a biological messenger in cells and participates in many physiological processes to avert adverse effects of salt stress in plants. In the present reported research, application of 200µl/l ETH as ethephon (ETH source) was studied individually (100 mg N /kg soil or 100 mg S /kg soil) or in combination with split form of (50N+50N+ 50S+50S) nitrogen (N) and sulfur (S) alleviated effects of 100 mM NaCl stress in mustard (*Brassica juncea* L.). Plants receiving ETH together with N and S exhibited lower superoxide ion accumulation under salt stress than the plants receiving ETH and N, S alone. These plants (receiving ETH + N+ S) exhibited increased N and S assimilation by increasing the activity of rate limiting enzymes ATP-sulfurylase (ATP-

S), and nitrate reductase (NR), and enzymes of antioxidant defense system; super oxide dismutase (SOD), catalase (CAT), ascorbate peroxidase (APX) and glutathione reductase (GR). These ETH induced response led to higher accumulation of cysteine (Cys), reduced glutathione (GSH) and proline with lesser oxidative stress and stimulated photosynthetic performance of plants. The study suggests that salt stress effects on photosynthetic performance of plants are mitigated more efficiently when ETH was applied in combination and split form of N and S and the photosynthetic activity was promoted under salt stress through increased N and S assimilation and antioxidant system.

Key Words: Ethylene, Sulfur, Nitrogen, Proline, Mustard, Salt stress

Evaluation of various insecticides for the management of mustard aphid, *Lipaphis erysimi* (Kalt.).

Manjeet Singh¹*, B. K. Kang¹ and Smriti Sharma¹

Department of Entomology, Punjab Agricultural University, Ludhiana, Punjab 141004

ABSTRACT

Under field conditions large variations in control efficacy have been observed which point towards development of insecticide resistance. Resistance is a natural mechanism for existence and excessive dependence upon chemical insecticides in recent years has resulted in development of resistance in insects. Laboratory studies were carried out to investigate the development of resistance in mustard aphid, *Lipaphis erysimi* (Kalt.) populations during 2019-20 and 2020-21, collected from six locations viz., Amritsar, Ludhiana, Bathinda, Shri Muktsar Sahib, Hoshiarpur and Ludhiana of Punjab, towards recommended insecticides and toxicity of novel insecticides towards this pest was also determined. Among different populations, Ludhiana population was found to be more susceptible with LC50 values (0.0005-0.0239%) to all tested insecticides whereas Shri Muktsar Sahib population was found to be least susceptible with LC50 values (0.0011-0.0595%). Thiamethoxam with LC50 values ranging from 0.0005 to 0.0011 per cent showed maximum toxicity followed by chlorpyrifos, oxydemeton methyl and dimethoate. Medium to high levels of resistance (16.2 – 74.2 x) was reported in *L. erysimi* towards dimethoate 30 EC, chlorpyrifos 20 EC and oxydemeton methyl 25 EC whereas, levels of resistance towards thiamethoxam 25 WG was found to be very low (2.5 – 5.5 x). Among new molecules viz., imidacloprid, clothianidin and acetamiprid, imidacloprid with LC50 values (0.00018-0.00040%) proved to be extremely toxic followed by clothianidin and acetamiprid. Baseline data of these new chemistry molecules will be helpful to detect the resistance levels in this pest in future.

Key words: *Lipaphis erysimi*, Insecticides, Insecticide resistance, Toxicity

Adaptability response and photosynthetic potential of stress-resilient sorghum [*Sorghum bicolor* (L.) Moench] to high salinity

Jayanti Tokas*, Himani Punia, Satpal, Sarita Devi and Neeraj Kharor

**Department of Biochemistry, College of Basic Sciences & Humanities, CCS Haryana Agricultural University, Hisar-125004, Haryana, India*

ABSTRACT

Soil salinization has become a major constraint affecting crop production worldwide. Salinity induces complex metabolic processes that involve ion toxicity, osmotic stress, biochemical and physiological perturbations. Sorghum is a gluten-free cereal crop, well adapted to semi-arid tropics, highly biomass productive, and water-efficient. Sorghum crop growing is an efficient way to utilize saline soils. Therefore, the present study aimed to assess sorghum genotypes' tolerance behavior under different salinity levels (60, 80, 100, 120, 140mM NaCl) concerning the performance of quality and yield traits. Amongst the screened 25 sorghum genotypes, G-46 behaved as salt-tolerant and CSV 44F as moderate genotype based on germination studies. The results indicated that increasing salt stress reduced the photosynthetic potential in both genotypes but less in G-46. The fresh and dry weight of leaves decreased with increasing salinity concentrations from 6 to 14 dS/m, with a maximum reduction at 14 dS/m (35 DAS: 87.9 %; 90 DAS: 84.2 %). The decrease in root and shoot length was less in G-46 (79.5 %) than CSV 44F (83.4 %) and respective controls. At 35 DAS, the plant height decreased significantly with the increasing levels of salinity. Least was noticed in G-46 (11.6 %) as compared to CSV 44F genotype (21.7 %). The relative water content (RWC) decreased gradually with the increasing salinity levels. A maximum decrease was observed in CSV 44F (76.2 %) and minimum in G-46 (52.2 %). The reduction in chlorophyll fluorescence of the leaf was maximum in CSV 44F (43.6 %) and minimum in G-46 (20.0 %). The reduction in chlorophyll stability index was more in CSV 44F (65.3 %) than G-46 (56.2 %). The sorghum response to salinity studied for three years (2018-19, 2019-20, and 2020-21) revealed that yield parameters of sorghum, in terms of green fodder yield and dry fodder yield measured at 50% flowering and maturity was increasingly impeded with increasing salinity levels. The percent decrease in GFY at 50% flowering was 14.94 and 18.15 in G-46 and 21.53 and 29.62 in S-713 at 10 and 12 dS/m and at 50% maturity, 16.13 and 22.38 in G-46 and 929.32 and 43.26 in S-713 at 10 and 12 dS/m, respectively. A similar trend was observed for DMY. Also, a positive correlation was observed between yield components and morpho-physiological and biochemical parameters except for HCN content in sorghum genotypes. Hence, G-46 performed better under high salinity and may be grown as a potential green fodder crop for livestock management in salinity-prone areas.

Keywords: chlorophyll, fodder yield, photosynthetic potential, quality, salinity, sorghum

Upscaling and Comparison of Beer Production by *Saccharomyces cerevisiae* Fermentation of Sweet Sorghum

Keshani* and Jasmine Kaur

Department of Microbiology, College of basic sciences and humanities, Punjab Agricultural University, Ludhiana, India

ABSTRACT

Tropical countries import barley from temperate countries to meet the demand of beer produced from barley malt. Hence, there is a need to search for alternate substrates to meet the increasing demand of beer and to reduce its cost. Sweet sorghum is one of the potential substrate for beer production. In the present work, fifteen varieties of sweet sorghum grains were evaluated for their potential as a substrate for beer production. Beer was produced using sweet sorghum and pilsner malt blend in the ratio of 40:60 respectively. Two yeast strains *Saccharomyces cerevisiae* GP4 and *S. cerevisiae* 11815 were compared for their fermentative capability of wort. Out of all the sweet sorghum varieties assessed, beer made from CSV 24SS using *S. cerevisiae* GP4 had highest alcohol content of 5.8% (v/v) and the highest sensorial acceptance. The CSV 24SS variety was then used for upscaled production (20 litres) of beer. The beer produced was pale gold in colour and had a pH of 4.2 and titrable acidity of 0.36%. The beer was evaluated by a panel of judges for its sensorial profile and received a mean score of 7.85 out of 9 on the Hedonic scale, which indicates its consumer acceptance same as that of commercial malt beer.

Keywords: Sweet sorghum, pilsner malt, beer, *Saccharomyces cerevisiae*

Review On Early Blight (*Alternaria* spp.) of Potato Disease and its Management Options

Chetana Jangde^{*1}, C.S.Shukla², H.K.Singh³ and Smriti Dhruw⁴

Department of Plant Pathology, College of Agriculture, Raipur- 492012

Department of Plant Pathology, College of Agriculture, Raipur- 492012 Scientist *Department of Plant Pathology, College of Agriculture, Raipur- 492012*

Department of Plant Pathology, College of Agriculture, Raipur- 492012

ABSTRACT

This review will be reviewed with a view to reviewing the economic significance of early-stage damage to potato plant disease and management options. Potatoes are the most important vegetable crop in terms of quantity produced and eaten worldwide. It is the world's fastest growing crop with a significant economic impact on many resource-poor farming families. However, its production is currently threatened by many biotic and abiotic barriers. The first potato disease, caused by two varieties of *Alternaria* (*A.solani* and *A. alternata*), is a major stumbling block in potato production in the world and in Ethiopia. Potato damage is still widespread throughout the world, wherever potatoes, tomatoes, peppers, and eggplants are grown. The disease can damage both potato leaves and root crops and can cause a loss of 5-50% yield. Early damage is a poly cyclic disease that can cause more than one epidemic in one planting season. It is difficult to control due to its ability to produce a large amount of secondary inoculum. As this disease is so important in causing economic losses to the potato crop, developing and implementing effective and efficient management practices is not in question. Applying good cultural practices and using chemical molds are important in reducing and controlling early potato disease. Although it is assumed that there is no well-developed

3rd International Conference on “Global Initiative in Agricultural, Forestry and Applied Sciences for Food Security, Environmental Safety and Sustainable Development (GIAFAS-2021)”

biological control for early injuries, it is very important to develop such management strategies. Because biological control measures are clear, efficient and environmentally safe.

Keywords: Alternaria; Fungicides; Resource-poor farming families; Secondary Inoculum ;Yield losse. 1.

Indigenous Technical Knowledge for Sustainable Agriculture

Sanjana Shrivastava, Sheetal Patel, Prashant Singh Kourav

Department of Extension Education, JNKVV, JABALPUR Madhya Pradesh,

ABSTRACT

Indigenous Technical Knowledge (ITK) has immense potential for innovation, especially at the grassroots level, ancient scriptures of India consisting of 4 Vedas, 108 Upanishads, 2 Epics, Bhagwadgita, Brahmasutras, 18 Purana, Manu Smiriti, Kautilya Shastra and Smritis as well as the teachings of innumerable sayings, proverbs and sages contain profound literature of ideas, concepts and practices which are designed to address the process of building harmonious relationship among man, animal and nature that enhance the quality of life of the Indians who in great majority live in and depend on agricultural production systems would be impossible by keeping this rich tradition of ITK aside. Indigenous knowledge is the knowledge that people in a given community have developed over time, and continue to develop. It is based on experience, often tested over centuries of use, adapted to local culture and environment, many sources of Indigenous Technical Knowledge is Farmers, community member especially elders are the best source of ITK, Folklore, Song, Poetry and Theatre can reveals a great deal about people value, history and practices. Indigenous knowledge system can help to meet the broader objectives of society, for instance conserving the environment, developing sustainable agriculture and ensuring food security, while its protection encourages the maintain of traditional practices and lifestyles, for Documentation of Indigenous knowledge need to collect the traditional knowledge information into written documents, drawing, recording, Notes, Photos, Audio-recordings, Video-recordings. Some of the commonly used Indigenous Technical Knowledge (ITK) is Spreading tobacco dust over the field to control insect, Detopping Aus rice plants when the vegetative growth is vigorous, Setting up bamboo sticks or branches of trees in rice field to sit down the birds and eat away insects which helps to control insect infestation, Spraying neem solution on the vegetables to control insects, Intercropping garlic and potato to minimize pest attack, Spraying cow dung mixed water in the field to prevent the attack of cattle and goat we can conclude that Indigenous Technical Knowledge is socially desirable economically affordable, sustainable, involves minimum risk and focus on efficient utilization of eco-friendly resources, by linking the knowledge system of the people with farmer, research, and extension, the output of researches can be made more fertile and usable.

Keywords- Indigenous Technical Knowledge, Natural resources, sustainable agriculture, Techniques of ITK.

Effect of Potassium Doses on Rice (cv. Pusa Basmati 1) Yield, Economics and Different forms of K in Vertisols of Madhya Pradesh

Bharti Parmar*, EktaJoshi, R.H. Wanjari

*RajmataVijayarajaScindiaKrishiVishwaVidyalaya,Gwalior&
ICAR-Indian Institute of Soil Science, Bhopal*

ABSTRACT

Rice (*Oryza sativa L.*) is most important cereal crop which is widely cultivated all over in Madhya Pradesh District. Rice is one of the most important food crop and feeds more than 60% population of our country. It forms the staple diet of about half of the world’s population and grown under diverse soil and climatic conditions. The challenge in current Indian agriculture is not only to produce more food to feed the rapidly growing population but also to maintain soil health and quality by balanced fertilization. The farmers

usually apply farm yard manure, nitrogen and phosphorous fertilizer to increase the rice yield and do not give good attention to potassium fertilizer. The experiment was conducted in fixed plots in a Randomized Block Design. The entire experimental area at the farmers’ field was divided into 6 (six) sampling blocks representing the replications to reduce soil heterogeneity. Each block was divided into 4 unit plots with raised bunds as per treatments. The four treatments were K₀ (0 kg ha⁻¹ K) (control), K₄₀ {40 kg ha⁻¹ Potassium}, K₈₀ {40 kg ha⁻¹ Potassium} K_{FP} {Farmers’ Practice} in Vertisols to conserve soil nutrient. The plant growth, yield and yield parameters were collected. According to the experimental results, different rates of K fertilizer application showed the significant effects on plant population, plant height, number of tillers m⁻², number of panicles plant⁻¹, grain and stover yield. The maximum grain yield (5495 kg ha⁻¹) was observed from the higher dose of K (80 kg of K ha⁻¹) In this treatment, plants were able to produce high number of grain panicle⁻¹ (255 number of grain panicle⁻¹) and filled grains (237 grain panicle⁻¹) with maximum straw yield (6223 kg⁻¹). Minimum grain yield was achieved at K₀ (control) with minimum straw yield. Therefore, the effect of 80 kg of potassium fertilizer treatments provided the higher grain yield. Under influence of different doses of potassium rice yield and WSK, AvK and NEK had exhibited the significant correlation except with exchangeable K in Vertisols. Ultimately, the better growth and highest yield of rice with application of potassium 80 kg ha⁻¹ had introduced significantly highest gross returns, net returns and B:C ratio of rice crop. Thus it may be concluded that the application of potassium 80 kg ha⁻¹ along with the recommended doses of N, P and Zn to rice crop resulted in the highest productivity, profitability and sustainability over suboptimal doses of potassium. So it is concluded that the application of 80 kg potassium ha⁻¹ results higher productivity, profitability and sustainability compare to other K Treatments.

Key words: Rice, Vertisols, WSK (water soluble potassium), AvK (Available potassium) NEK (Non-exchangeable potassium), Exchangeable,

Popularization of medicinal plant-based Agroforestry practices for higher income to the farmers and conservation of medicinal plant resources

Arun Kumar Shukla¹, K. K. Chandra²

¹ *Department of Forestry, Wildlife & Environmental Sciences*

² *Department of Forestry, Wildlife & Environmental Sciences, Guru Ghasidas Vishwavidyalaya (A central University) Bilaspur, Chhattisgarh, India.*

ABSTRACT

Agroforestry system is an integrated land management system that includes tree into land already used for crop and animal farming. This technology seems to be a climate smart production system owing to the impact of future climate for ensuring food and climate security. However, the technology needs to popularize among farming communities by encouraging them for commercial and sustainable production of multiple outputs. Among different commercial agroforestry practices the combination of trees with medicinal plants provide more remunerative to the farmers than the other traditional cropping. There are increasing demand of medicinal valued plant worldwide and

3rd International Conference on “Global Initiative in Agricultural, Forestry and Applied Sciences for Food Security, Environmental Safety and Sustainable Development (GIAFAS-2021)”

its domestication are found to be beneficial for doubling the income of farmers. Although, medicinal plants occur in natural forests, but due to the increasing pressure and unscientific exploitation of these plants they are vanishing from their natural habitat. Agroforestry has the potential and prospects for the conservation, and sustainable use of these valued plants through their cultivation along with tree farming. World Bank reports 2019 advocates that more than 80% population rely on natural product and food supplements. In this paper, we have explored the potential of different forest species combined with medicinal plants in agroforestry practices and evaluated its production economics.

Keywords: Agroforestry, conservation, medicinal plant, cultivation, traditional

Measuring total factor productivity in dairying in arid western Rajasthan Dropati Saran¹, Madhu Sharma², Rajesh Sharma³ and Hemant Sharma⁴

^{1,2&3}College of Agriculture, SKRAU, Bikaner 334001

⁴Agro Economic Research centre, SPU, Anand, Gujarat 388120

ABSTRACT

Livestock assumes the role of a guard for farmers, especially for the small and marginal. The significance of the sector further increase in arid western Rajasthan where frequent droughts are the primary concern. The growth factor other than inputs such as technology, support services and market has special significance in adaption of droughts. This study analyses role of Solo residuals in dairying in the arid western zone of Rajasthan using the primary data collected 180 households of Bikaner district from the region. We used Divisia-Tornqvist indexing approach to compute total factor productivity (TFP). The results indicated that the factor productivity is in crossbred cows (0.245) due to high genetic potential and better feeding practices. Total factor productivity across the herd size indicated that the productivity increases with increase in herd size. However, diseconomies of scale were also noticed in case of local cattle and buffalo. Better feeding, breeding and management practices with livestock support services are needed for dairy development in the region.

Key words: Total factor productivity, herd size category, milk production

Nutri-smart village: Taking steps toward nutrition security Arvind Preet Kaur and Manisha Bhatia

Krishi Vigyan Kendra, Fatehgarh Sahib

ABSTRACT

Punjab known as the food bowl of the nation is self-sufficient in production of food grains. But this self-sufficiency has not been translated into nutritional security. In order to fulfill the daily nutritional requirement of the family members there is need to have an integrated approach where the families are self-sufficient in terms of their requirements of vegetables, fruits, pulses, oilseeds, milk and milk products. In order to avert nutritional insecurity and to make the adequate quantity and quality of food accessible to rural families idea of nutri-smart village was conceptualized by Krishi Vigyan Kendra, Fatehgarh Sahib. Interventions in the form of various PAU recommended practices including vegetable nutrition garden kit, fruit nutrition garden, wheat PBW Zn 1, pulses and oilseed kits, summer *moong*, gram, lentil, mushroom bags, GSC-7, PAU Fruit Fly traps for fruits and vegetables were done in 60

3rd International Conference on “Global Initiative in Agricultural, Forestry and Applied Sciences for Food Security, Environmental Safety and Sustainable Development (GIAFAS-2021)”

families of village Sidhuwal. Various extension activities such as trainings and method demonstrations on fruit and vegetable nutrition garden, preservation of fruits and vegetables, field days on vegetable nutrition garden, pulses & oilseeds as well as group meetings were conducted in the village. Time to time advisories, monitoring and guidance visits regarding use of kitchen waste as compost in vegetable and fruit nutrition garden was also done. Analysis of data revealed that after intervention in the village there was increase in production of pulses and oilseeds by 17.2 and 38.8 percent respectively. This decreased the gap in availability of pulses and oilseeds as per RDA from 33.48 and 14.49 to 14.52 and 3.08 g/ day/ person respectively. The fruit production also increased by 37.5 percent due to better management of existing fruit plants and overall availability of vegetables & fruits from a deficit of 63.07 g increased to a surplus availability of 163.5 g compared to RDA landmark of 300 g/ person/day. These efforts also resulted into increased area under vegetable crops, but also increased production by 19.5 percent. The intervention also resulted in availability of mushroom by 20.6 g mushroom/per person per annum. Data further shows the availability of fresh vegetables to the families round the year. There was shift in the consumption pattern after the intervention as indicated from the fact that before intervention potato was highly consumed as compared to other nutrient rich vegetables. While with the intervention for 3 years there was an increase in the annual average consumption of vegetables, fruits and pulses which were earlier brought rarely or occasionally. The interventions were economically beneficial as well.

Comparative Economics of Paddy Cultivation by Transplanting, Drilling and Broadcasting Methods of Paddy Cultivation in Gadchiroli District of Maharashtra

A S Tingre , N V Shende and R D Vaidkar

Dr PDKV, Akola

ABSTRACT

The present study has been taken in Gadchiroli district of Vidarbha. Gadchiroli is one of the major paddy growing district of Vidarbha and it comes under the high rainfall zone. Paddy is the major kharif crop grown in the district. The cropping pattern of the district is dominated by the paddy crop. Two tahsils of the Gadchiroli district namely Gadchiroli and Chamorshi were purposively selected for the study. From each tahsil three villages were selected and from each village twenty farmers were selected randomly. In all 120 farmers were selected for the present study.

The highest cropping intensity was observed in the farmers group adopting SRI method (180.78%) followed by drilling method (172.15%), conventional transplanting method (158.00%) and broadcasting method (126.31%) respectively. The highest gross returns received to farmers adopting SRI method of cultivation i.e. Rs.100102/- per hectare followed by conventional transplanting method Rs 74947/-, drilling method Rs.70042.75/- and broadcasting method Rs.33701.00/-. The highest gross returns received to farmers adopting SRI method of cultivation i.e. Rs.100102/- per hectare followed by conventional transplanting method Rs 74947/-, drilling method Rs.70042.75/- and broadcasting method Rs.33701.00/-. The highest BC ratio was realised by the farmers adopting drilling method of paddy cultivation at Cost A, Cost B and Cost C respectively.

Key words: Cost A,B and C, B:C ratio

Effect of Potassium Doses on Rice (cv. Pusa Basmati 1) Yield, Economics and Different forms of K in Vertisols of Madhya Pradesh

Bharti Parmar*, Ekta Joshi, R.H. Wanjari

Rajmata Vijayaraja Scindia Krishi Vishwa Vidyalaya, Gwalior &

ICAR-Indian Institute of Soil Science, Bhopal

ABSTRACT

Rice (*Oryza sativa L.*) is most important cereal crop which is widely cultivated all over in Madhya Pradesh District. Rice is one of the most important food crop and feeds more than 60% population of our country. It forms the staple diet of about half of the world's population and grown under diverse soil and climatic conditions. The challenge in current Indian agriculture is not only to produce more food to feed the rapidly

3rd International Conference on “Global Initiative in Agricultural, Forestry and Applied Sciences for Food Security, Environmental Safety and Sustainable Development (GIAFAS-2021)”

growing population but also to maintain soil health and quality by balanced fertilization. The farmers usually apply farm yard manure, nitrogen and phosphorous fertilizer to increase the rice yield and do not give good attention to potassium fertilizer. The experiment was conducted in fixed plots in a Randomized Block Design. The entire experimental area at the farmers’ field was divided into 6 (six) sampling blocks representing the replications to reduce soil heterogeneity. Each block was divided into 4 unit plots with raised bunds as per treatments. The four treatments were K₀ (0 kg ha⁻¹ K) (control), K₄₀ {40 kg ha⁻¹ Potassium}, K₈₀ {40 kg ha⁻¹ Potassium} K_{FP} {Farmers’ Practice} in Vertisols to conserve soil nutrient. The plant growth, yield and yield parameters were collected. According to the experimental results, different rates of K fertilizer application showed the significant effects on plant population, plant height, number of tillers m⁻², number of panicles plant⁻¹, grain and stover yield. The maximum grain yield (5495 kg ha⁻¹) was observed from the higher dose of K (80 kg of K ha⁻¹) In this treatment, plants were able to produce high number of grain panicle⁻¹ (255 number of grain panicle⁻¹) and filled grains (237 grain panicle⁻¹) with maximum straw yield (6223 kg⁻¹). Minimum grain yield was achieved at K₀ (control) with minimum straw yield. Therefore, the effect of 80 kg of potassium fertilizer treatments provided the higher grain yield. Under influence of different doses of potassium rice yield and WSK, AvK and NEK had exhibited the significant correlation except with exchangeable K in Vertisols. Ultimately, the better growth and highest yield of rice with application of potassium 80 kg ha⁻¹ had introduced significantly highest gross returns, net returns and B:C ratio of rice crop. Thus it may be concluded that the application of potassium 80 kg ha⁻¹ along with the recommended doses of N, P and Zn to rice crop resulted in the highest productivity, profitability and sustainability over suboptimal doses of potassium. So it is concluded that the application of 80 kg potassium ha⁻¹ results higher productivity, profitability and sustainability compare to other K Treatments.

KEY WORDS: Rice, Vertisols, WSK (water soluble potassium), AvK (Available potassium) NEK (Non-exchangeable potassium), Exchangeable,

Effect of seaweed extract on growth performance of chilli (*Capsicum annum* L.) in Alfisols of Konkan (M.S.).

V.D. Kapse, K. P. Vaidya, M. C. Kasture N. B. Gokhale, B. R. Salvi and J.S. Dhekale

Department of Soil Science and Agril. Chemistry, Dr. Balasaheb Sawant Konkan Krishi Vidyapeeth, Dapoli- 415 712, Dist. Ratnagiri (Maharashtra)

ABSTRACT

A field experiment was conducted during the year 2017 -18 and 2018-19 entitled, “Effect of seaweed extract on yield, quality, nutrient uptake, soil properties and growth performance of chilli (*Capsicum annum* L.) in Alfisols of Konkan (M.S.)” at Department of Agronomy, D.B.S.K.K.V, Dapoli. The experiment was laid out in Randomized

3rd International Conference on “Global Initiative in Agricultural, Forestry and Applied Sciences for Food Security, Environmental Safety and Sustainable Development (GIAFAS-2021)”

Block Design (RBD) comprising sixteen treatment combinations replicated thrice and observations were recorded at 30, 60 days after transplanting (DAT) and after harvest. The effect of seaweed extract on growth attributing characters i.e. height, number of branches of chilli (cv. Pusa jwala) were studied. The application of 100 per cent RDF along with foliar application of 0.2 per cent seaweed extract (T₈) showed positive influence on growth attributing characters (Plant height and Number of branches per plant) of chilli

Keywords:- Seaweed Extract, Chilli, Plant height, Number of branches per plant

Impact of seaweed extract on yield of chilli (*Capsicum annum* L.) in Konkan region of Maharashtra

V.D. Kapse, K. P. Vaidya, M. C. Kasture N. B. Gokhale and S. B. Dodake and S.S. More

Department of Soil Science and Agril. Chemistry, Dr. Balasaheb Sawant Konkan Krishi Vidyapeeth, Dapoli- 415 712, Dist. Ratnagiri (Maharashtra)

ABSTRACT

A field experiment was conducted during the year 2017 -18 and 2018-19 entitled, “Effect of seaweed extract on yield, quality, nutrient uptake, soil properties and growth performance of chilli (*Capsicum annum* L.) in Alfisols of Konkan (M.S.)” at Department of Agronomy, D.B.S.K.K.V, Dapoli. The experiment was laid out in Randomized Block Design (RBD) comprising sixteen treatment combinations replicated thrice and observations were recorded at 30, 60 days after transplanting (DAT) and after harvest. The application of 100 per cent RDF along with foliar application of 0.2 per cent seaweed extract (T₈) showed positive influence on growth, yield attributing characters, yield, nutrient content, nutrient uptake and quality of green chilli. Conjunctive use of 100 per cent RDF along with foliar application of 0.2 per cent seaweed extract (T₈) caused enhancement in green pod yield (12.17 t ha⁻¹ and 13.09 t ha⁻¹) of chilli.

Keywords:- Seaweed Extract, Chilli, Yield.

Effect of new formulation of micronutrients on growth, yield and economic feasibility of wheat in sandy loam soil of Western Uttar Pradesh

¹*Anand Singh, ²U.P. Shahi, ¹Omkar Singh, ¹Prashant Deo Singh, ¹Shakti Om Pathak

¹ Soil Science & Agril. Chemistry, SVPUAT, Meerut

² Soil Science & Agril. Chemistry, SVPUAT, Meerut

ABSTRACT

An experiment entitled as “effect of new formulation of micronutrients on growth, yield and economic feasibility of wheat in sandy loam soil of Western Uttar Pradesh” was conducted on wheat crop for two consecutive years (2017-18 and 2018-19) at the Crop Research Centre, Sardar Vallabhbhai Patel University of Agriculture & Technology, Meerut-250110.

The experiment was laid out in randomized block design with 3 replication and 12 treatments. The treatments consisted T₁ Control (N:P:K 120:60:40 kg ha⁻¹), T₂ (T₁ +soil application of ZnSO₄ @ 25 kg ha⁻¹), T₃ (T₁ + soil application of Zn HEDP @ 5 kg ha⁻¹), T₄ (T₁ + foliar application of Zn HEDP @0.5 %), T₅ (T₁ + soil application of MnSO₄@ 12.5 kg ha⁻¹), T₆ (T₁ + foliar application of EDTA Mn @ 0.5%), T₇ (T₁ + soil application of Colemanite @ 7.5 kg ha⁻¹), T₈(T₁+soil application of Borax @ 10 kg ha⁻¹), T₉ (T₁ + foliar application DOT) @ 0.3 %), T₁₀ (T₁ + soil application of ZnSO₄+ MnSO₄+ Borax), T₁₁ (T₁ + soil application of Zn HEDP + MnSO₄+ Colemanite), T₁₂ (T₁

3rd International Conference on “Global Initiative in Agricultural, Forestry and Applied Sciences for Food Security, Environmental Safety and Sustainable Development (GIAFAS-2021)”

+ foliar application of Zn HEDP + EDTA Mn + DOT). The wheat cultivar (PBW-590) was sown with a seed rate of 120 kg ha⁻¹. Split dose of N, the full dose of P, K and soil application of Zn, Mn and boron at the time of sowing. Foliar application of different micronutrients in wheat was made at three different intervals tillering, jointing and booting stage. The growth, yield and economic feasibility were assessed during experiments.

The findings of experiment revealed that the growth attributes and yield of grain and straw was maximum with application of T₁₁ (soil application of Zn HEDP + MnSO₄ + Colemanite with RDF) followed by RDF + foliar application of Zn HEDP + EDTA Mn + DOT. The chelated zinc, manganese and colemanite was superior among zinc, manganese and boron sources over ZnSO₄, MnSO₄ and borax, respectively. The highest net return obtained with T₁₁ while B:C ratio was superior in T₁₂ where foliar application of all three micronutrients along with NPK.

Thus a balanced nutrient application in a right amount, right method and right time is found to be better in improving the every aspect of wheat cultivation.

Key words: Wheat, HEDP, EDTA, DOT

Agri Business Incubator, SKUAST-Jammu: A New Paradigm for Young Agri-Entrepreneurs

Jyoti Kachroo

Sher-e-Kashmir University of Agricultural Sciences & Technology, Jammu (J&K)

Rashtriya Krishi Vikas Yojana – Remunerative Approaches for Agriculture and Allied Sectors Rejuvenation (RKVY-RAFTAAR) is an important scheme of Government of India aimed to develop agri-start-ups, agri-innovation in agriculture and its allied sector by providing financial support and was launched in the year 2018. It was started simultaneously at National level in 29 different institutes and Universities and Sher-e-kashmir University of Agricultural Sciences and Technology of Jammu is also one of them. The scheme is functional in the Division of Agricultural Economics and Agribusiness Management where Agri-Business Incubator - SKUAST-Jammu (ABI-SKUAST-Jammu) was established for carrying out all the activities under the RKVY-RAFTAAR scheme to promote agri-startups. Three main components are executed under the scheme viz. Seed stage funding, agripreneurship orientation programme and pre-seed stage funding to the incubates. SKUAST-Jammu initiated both the programmes namely UDGAM-pre seed stage and PRAGATI-seed stage funding where grant-in-aid is upto 5 lakhs and 25lakhs, respectively. Focus areas of these two start-up programmes are organic farming, animal husbandry, agricultural biotechnology, hi-tech vegetable nursery, genetic upgradation of basmati rice, agricultural marketing & supply chain management, crop management technology, farm mechanisation in hill agriculture, apiculture, bio-agents for pest control and post harvest processing etc. Since the initiation of the programme, ABI-SKUAST-Jammu has graduated twenty seven incubates in two batches and out of them, fourteen innovative start-ups are selected for grant-in-aid ranging from Rs. 3 lakhs to the maximum of Rs. 25 lakhs depending upon the idea and stage of agri-startup. Five start-ups of first batch each executed their start-up idea and are achieving success in their milestones. These include Saptkrishi Scientific Pvt. Ltd. Where incubate developed Preservator/'sabzi kothi,' which is a low-cost, storage cum transportation solution for extending the shelf-life of horticultural produce anywhere between 7 to 30 days. Another start-up Salutem Ridegear Apparels Pvt. Ltd manufactured a product from the plant extracts which is organic in nature can be used in all types of Agriculture and Horticulture produce as a replacement of plant protection chemicals and growth hormones. He is working on nano- technology which makes plants retain water upto 300% for later use in case of scarcity. Vaatika Agro Services keeping in mind demand of Jammu and Kashmir Union Territory, conceptualize an idea of producing disease free high quality seedlings using soil less media like coco-peat, vermi-compost. ABI-SKUAST-Jammu also promotes women entrepreneur with one of its MBA (ABM) student having a unique idea of converting floral waste, agricultural waste and even domestic waste into useful product like incense sticks, essential oils, soaps and organic compost. Kdhariwal Agrotech and IT Services Private Limited also succeed in showing his presence in the market with his innovative product namely crop recharger which is formed by converting paddy crop wastage into organic and natural manure. The product is

finally available in liquid form with multiple modes of action offered by recharger produce healthier plants and enhance higher yields. All these start-ups are successful in achieving growth in terms of business and development and therefore current start-up based grant-in-aid needs to be made available with more functional and financial autonomy. This will help technology-transfer processes to develop agri-based start-ups. Agri-business Incubator – SKUAST-Jammu is working hard and providing all technical and academic support as well as mentorship to the budding start-ups for their growth and development.

Keywords: Incubation, incubator, agribusiness, RKVY-RAFTAAR, start-ups.

Genetic Diversity Assessment of Teak (*Tectona grandis* Linn. F.) clones of Clonal Seed orchard, Odisha

H. Nayak^{1*}, A. Sinha², N. Bhol³ and Jai Kumar⁴

^{1&3} College of Forestry, OUAT, Bhubaneswar, 751003 (Odisha), India*

**hiranmayee.nayak@gmail.com*

² Institute of Forest Productivity, Ranchi, Jharkhand

⁴ Faculty of Forestry, BAU, Ranchi, Jharkhand

ABSTRACT

To find out the inter-clonal variation in terms of growth performance and genetic variability of 25 Teak clones, grown at a spacing of 6m x 6m in a clonal orchard at Silvicultural Research Station, Koshala, Angul, Odisha, an investigation was carried out by taking its different growth parameters at two consecutive years i.e. at 30th and 31st years of age. Clone ORANP-17 exhibited maximum and significantly superior DBH (31.02cm), height (21.90m) and stem volume (118.10m³/ha) with MAI of 3.81m³/ha/yr. The highest CAI in DBH and volume was recorded as 1.56cm and 17.48 m³ respectively in case of ORANP-17. ORANP-17 and ORANP-16 were the best clones who gave maximum DBH as well as tree height both at 30th and 31st years. Maximum CAI and MAI in DBH, height and CAI and MAI of volume of stem were also recorded significantly superior for ORANP-17 and ORANP-16. Growth characters like tree height showed highest heritability (99.27%) followed by DBH (98.81%) and CAI and MAI in stem volume showed significantly higher value of heritability (99.84%). Highest value of genetic advance found for MAI of stem volume (47.84 and 61.31% at 5% and 1% respectively). Tree height and DBH contributed maximum towards divergence in Teak clones of Clonal Orchard. 25 Teak clones were grouped into 8 clusters in which maximum intra cluster divergence was noticed for cluster II. Maximum inter-cluster divergence was noticed between cluster II and VIII and maximum number of 10 germplasm came in cluster I. Cluster VIII consists of most superior clone of Teak, because it gave maximum value for all the growth parameters. Based upon the results obtained for Clonal Orchard, Teak clones like ORANP-17 and ORANP-16 could be screened out as superior clones. It can be inferred that appropriate improvement is possible in MAI as well as CAI in stem volume of different Teak clones by providing adequate silvicultural and cultural practices, however little improvement can be achieved in tree height and DBH of Teak clones.

KEY WORDS: Clonal seed orchard, Genetic diversity, MAI, CAI, Stem Volume Heritability, Genetic Advance

Carbon trading: a viable option for mitigating climate change

Monika Menia*

Division of Agronomy, Faculty of Agriculture, SKUAST- Jammu, Main Campus, Chatha, Jammu & Kashmir-180009

ABSTRACT

With the acceleration of urbanization, urban areas play a major role in energy consumption and CO₂ emissions in Asian countries. The impact of urbanization on energy use of fossil fuels has unequivocally disturbed and increased the carbon levels in the atmosphere, causing warming. Carbon trading is a form of emission trading which involves buying and selling of credits that permit a company or other entity to emit a certain amount of carbon dioxide. This form of permit trading is a common method countries utilize in order to meet the obligations specified by Kyoto Protocol; namely the reduction of the carbon emissions in an attempt to mitigate the future climate change. There are two types of carbon markets *viz.* compliance and voluntary markets wherein credits are generated and are being traded. Carbon credit is a generic term for any tradable certificate or permit representing the right to emit one ton of CO₂ or the mass of another greenhouse gas with a CO₂ equivalent to one ton. Kyoto’s three flexible mechanisms *viz.* clean development mechanism (CDM), joint implementation (JI) and international emission trading (IET) provide the market mechanism for carbon emission. A number of emission trading schemes have been developed by various regions across the world. The value of the global carbon market increased by 20% in 2020 to \$272 billion. Under the context of climate change, forests as carbon sinks play an important mitigatory role. The world’s forests store more than 650 Gigatonne of carbon, 44% in the biomass, 11% in dead wood and litter and 45% in the soil. Conventional mitigation technologies focus on reducing fossil-based CO₂ emissions. Negative emissions technologies are aiming to capture and sequester atmospheric carbon to reduce carbon dioxide levels. Finally, geoengineering techniques of radiative forcing alter the earth’s radiative energy budget to stabilize or reduce global temperatures. Immediate development of viable mitigation and adaptation mechanisms is of extreme importance, based on the current state of climate emergency. In crux, the strengthening of existing carbon markets, the development of new allowance trading systems and the combination of all these, aided by the use of new technologies and controlled and governed by a globalized civil society whose political power can no longer be overlooked, constitute, the way forward in the fight against global warming.

Keywords: Carbon credit, Kyoto protocol, forests and carbon markets.

Rapid human population- root threat to biological diversity

Monika Menia*

Division of Agronomy, FOA, SKUAST- Jammu, Main Campus, Chatha, Jammu & Kashmir- 180009

ABSTRACT

Biodiversity is the part of nature which includes the differences in genes among the individuals of species. The diversity of life on earth is so great that if we use it sustainably we can go on developing new products from biodiversity for many generations. The unprecedented rate at which biological diversity of earth is declining can be blamed primarily on the rapidly increasing human population. Rapid growth of human population and consumption pressures are the root threats to biodiversity that resulted in the increase of human need for earth’s natural resources. The main threats facing biodiversity worldwide are not only destruction, degradation and fragmentation of habitats but also reduction of individual survival and reproductive rates through exploitation, pollution and introduction of alien species. It has been estimated that more than 47,000 species are found that 36% of these are threatened with extinction, the state whereby no live individual of a species remain. Species extinction, endangerment and

ecosystem degradation are not the aims of human societies, but are the unfortunate by product of human activities. This can only happen if future human efforts to better manage and protect the planet’s biological riches will depend on innovations in both the sciences and the world of policies and regulation. Better integration of science into law and policy through the work of new generations of professionals is one of the keys to sustaining biodiversity.

Key Words: Biological diversity, Extinction, Habitat degradation, Human population

Vertical farming-an approach towards sustainable agriculture

Monika Menia^{1*}, Jyoti Sharma² and Meenakshi Attri³

^{1,2,3}Division of Agronomy, Faculty of Agriculture, Sher-e-Kashmir University of Agricultural Sciences & Technology- Jammu, Main Campus, Chatha, Jammu & Kashmir- 180009

ABSTRACT

Increasing food demand due to growing population along with ever decreasing arable lands act as one of the greatest challenges. The high yield farming methods that support our immense population are characterized by instable consumption of limited reserves of fresh water, fossil fuel and soil. By 2050, around 80% of world population is expected to live in urban areas, and the growing population will lead to an increasing demand for food. In order to overcome the harmful impact, it is the need of hour to shift towards vertical farming. Vertical Farming is the advanced level of agriculture technology which has been practiced when there is unavailable of land and other requirements for the perfect structure of farming mode. The efficient use of vertical farming may play a significant role in preparing for such a challenge. Vertical farming can also be a great solution for some of the current social trends, such as the local food movements, increased technical job availability, in addition to the need for food security in urban areas, and the level of food self-sufficiency. Within the vertical farm there is the possibility to grow continuous healthy, pesticide/herbicide-free crops all year-round at high rates because of the indoor controlled environment. It allows us to produce crops with 70-95% less water than required for normal cultivation. It has higher efficiency than traditional agriculture due to higher production quantities each year and lower losses. Indoor vertically farming uses high technology, requiring facilities to have a holistic control over the production. It can create a balanced environment, although landscape agriculture has to be maintained as long as we get accommodated to this new technique. It has the potential for success in proper conditions. It simultaneously helps to reduce poverty, adds to food safety, and increases contextual sustainability and human well-being.

Key words: Vertical farming, Food security, Environment and Sustainability.

Rainfall variability analysis of onset of monsoon in different agro climatic regions of Eastern Uttar Pradesh

AJIT SINGH^{1*}, A.K. SINGH², S.C. BHAN³, and S.R. MISHRA⁴

¹(Agriculture Meteorology) KVK, Damla, Yamunanagar, CCS HAU, Hisar (Haryana)

^{1,4} Deptt. Of Agriculture Meteorology, NDUA&T, Kumarganj, Ayodhya (U.P)

³⁻ F, DGM, Agromet Advisory Services Division IMD (New Delhi)

ABSTRACT

It is quite evident from the data analysed over last 30 years (1986-2015) that annual rainfall of Eastern U.P gradually declined over the normal 1000 mm. Seasonal rainfall variability (mm) of Eastern U.P have been presented and depicted S-W monsoon, Post monsoon, winter season per monsoon season. S-W monsoon and Post monsoon rainfall of Eastern U.P declined over the normal in recent years. Rainfall variability during different seasons of Eastern U.P have been presented. It is obvious from the data that rainfall occurred during winter season, summer season and SW monsoon periods were decreased while during post monsoon season rainfall was slightly increased by + 0.3% in the recent years to come. While trend of rainfall during winter and summer seasons found increased over the normal in recent years to come. The characteristics of rainfall of Eastern U.P. i.e. onset and withdrawal of monsoon from 1986 to 2015 revealed that shift of onset of monsoon in all the zones from 4 to 6 days toward rainy season consequently length of rainy season also shift on an average 5 to 6 days early. Withdrawal of SW monsoon in

3rd International Conference on “Global Initiative in Agricultural, Forestry and Applied Sciences for Food Security, Environmental Safety and Sustainable Development (GIAFAS-2021)”

all the zones in recent years was found almost same i.e 24-26 September. Data analysis over past 30 years quite reveal that intensity of rainfall during monthly basis and whole S-W monsoon period were decreased in recent years.

Integrated Pest Management: A boon to farmers

Rabindra Prasad, A. Narayan, Neeraj Kumar and G.S. Giri

TCA, Dholi, Dr. Rajendra Prasad Central Agricultural University, Pusa (Samastipur), Bihar, 848125

ABSTRACT

Integrated Pest Management (IPM) is an effective and environmentally sensitive approach to pest management that relies on a combination of all possible practices. IPM programs use current comprehensive information on the life cycles of pests and their interaction with the environment. Traditional pest control involves the routine application of pesticides. IPM, in contrast, focuses on pest prevention and uses pesticides only as needed. This provides a more effective and eco-friendly approach. IPM programs take advantage of all appropriate pest management strategies, including the judicious use of pesticides along with other practices. Preventive pesticide application is limited because the risk of pesticide exposure may outweigh the benefits of control, especially when non-chemical methods provide the same results. IPM is not a single pest control method but rather involves integrated multiple control methods based on site information obtained through inspection, monitoring and reports. Successful IPM programs use this four-tiered implementation approach; identify pest and monitoring, set action thresholds, prevent and control. IPM focuses on prevention by removing conditions that attract pests, such as food, water, and shelter. Preventive actions include: reducing clutter sealing areas where pests enter the building (weatherization), removing trash and overgrown vegetation, maintaining clean dining and food storage areas, installing pest barriers, removing standing water, educating building occupants on IPM. Pest control is required if action thresholds are exceeded. IPM programs use the most effective, lowest risk options considering the risks to the applicator, building occupants, and environment. Control methods include: pest trapping, heat/cold treatment, physical removal, pesticide application. IPM offers several benefits. It helps to reduce the number of pests, reduce the number of pesticide applications, save money while protecting human health. There are cost savings associated with using IPM. IPM may be more labour intensive than conventional pest control and may require more up front resources. However, costs are generally lower over time because the underlying cause of the pest problem has been addressed. IPM technology manages the pest population in such a manner that economic loss is avoided and adverse side effects of chemical pesticides are minimized. The IPM packages encompass various management strategies for containing the pest and disease problems. Pest monitoring is also one of the important component of IPM to take proper decision to manage any pest problem.

Keywords: Integrated Pest Management, eco-friendly, strategies.

Insight into phenotypic screening of tossa jute against salinity stress

M.M. Mukul*, N. Akter and M.G. Mostofa

Breeding Division, Bangladesh Jute Research Institute, Ministry of Agriculture, Manik Mia Avenue, Dhaka, Bangladesh.

ABSTRACT

Salinity stress is a serious threat to jute cultivation in saline or coastal areas of Bangladesh. *Corchorus olitorius* jute is very susceptible to salinity stress. There is no salt tolerant tossa jute variety has been developed in Bangladesh. Twenty two tossa jute genotypes were primarily investigated for salinity tolerance in field condition having 7.86–7.93 dS m⁻¹ salinity level followed by the augmented design. No salinity tolerant control variety was used here, and the salt tolerant genotypes were phenotypically screened based on plant survivability, vegetative growth, height & girth of stem, fibre yield capacity. Among 22 jute genotypes, the Acc. 4160 and Acc. 2311 showed good fibre yield (18.00 and 13.80 g plant⁻¹, rep.) and lower mortality rate (5.67 and 8.0%, resp.) than the existing good fiber yielding tossa jute varieties namely O-9897 (9.0 g plant⁻¹, 57.33%), BJRI Tossa Pat-5 (13.0 g plant⁻¹, 12.67%) and JRO-

524 (13.40 g plant⁻¹, 11.33%). The fiber yield significantly depends on plant population, height & girth of stem etc. These morphological characters showed high heritability in a broad sense, genetic advance (%) of mean. The genotypes Acc. 4160 and Acc. 2311 would be used as good source of salt tolerance gene(s), and salinity tolerant tossa jute variety would be developed through gene introgression from these genotypes by conventional breeding or molecular breeding approaches. The information would be used for jute crop improvement in future.

Performance of maize (*Zea mays*) as influenced by drip irrigation schedules and nitrogen levels

Y. DEEPTHI KIRAN, V. SUMATHI AND G. PRABHAKARA REDDY

Department of Agronomy, S.V.Agricultural College, Tirupati-517 502, Andhra Pradesh

ABSTRACT

Knowledge of existing natural resources is one of the most basic pre-requisite to utilise them effectively in a sustained manner. Indian agriculture is increasingly challenged by water scarcity, weather vagaries and volatility, increasing the risk of production shortfalls. Water and nitrogen are two important resources for crop production. Yield in maize responds positively with an increase in the amount of water and nitrogen applied and reaches the plateau at their optimum doses. Field experiments were conducted over two consecutive years (2013-14 and 2014-15) at S. V. Agricultural College, Tirupati, Andhra Pradesh to study the growth, yield and quality of maize under different irrigation schedules and nitrogen levels. The experiment was laid out in split plot design, replicated thrice by taking four irrigation schedules as main plots and three nitrogen levels as sub plots. The growth parameters of maize viz., plant height, leaf area index and total dry matter production were considerably influenced by irrigation schedules and nitrogen levels. With respect to interaction, irrigation schedules and nitrogen levels exerted significant influence on all the growth parameters at all stages of sampling except at 30 DAS. Higher yield of maize was obtained with weekly check basin irrigation, which was on par with drip irrigation at 0.9 IW/CPE ratio. Among the nitrogen levels tried, the highest yield was obtained with 240 kg N ha⁻¹. The interaction between the irrigation schedules and nitrogen levels indicated that higher yield was found with scheduling irrigation either by weekly check basin method or by drip irrigation at 0.9 IW/CPE ratio along with 240 kg N ha⁻¹. Protein content in maize was significantly influenced by the irrigation schedules and nitrogen levels, while the interaction effect was statistically not traceable. Irrigation schedules significantly influenced the starch content in maize, where as the nitrogen levels failed to exert significant effect. Increase in irrigation levels significantly influenced the starch content of maize kernel. The experimental findings revealed that maize can be grown economically with limited water supply at 0.9 IW/CPE ratio through drip irrigation along with 240 kg N ha⁻¹.

Relative performance of wheat (*triticum aestivum*) varieties under different residue management and tillage systems

Kapil malik^{1,*}, O. P. Lathwal¹, abhliash², A. K. Dhaka¹ and pankaj dah iya²

^{1,2}CCS Haryana Agricultural University, Hisar, Haryana

ABSTRACT

Two year experiment was conducted at research farm of college of agriculture, Kaul, CCS Haryana Agricultural University, Hisar during *rabi* seasons of 2017-18 and 2018-19 to examine the performance of wheat varieties under various residue management practices and tillage systems. The investigation was carried out in strip plot design (SPD) with three replications keeping sowing methods in main plots and varieties in subplots. Six wheat varieties namely HD 3086, HD 2967, WH 1105, WH 1124, WH 711, and WH 1142 were grown under four sowing methods such as wheat sown with turbo seeder with full residue retention, wheat sown with turbo seeder with intact rice residue, wheat sown with zero till seed cum fertilizer drill with no residue, and wheat sown in conventional tillage conditions with no residue. Results of the experiment had shown that among different wheat varieties, HD 3086 recorded maximum seed, straw and biological yield which was significantly higher than rest of varieties but statistically at par WH 1105 and HD 2967 varieties. Among sowing methods, growth of wheat crop was improved under turbo seeder with full residue retention sowing method, and recorded significantly higher seed, straw and

3rd International Conference on “Global Initiative in Agricultural, Forestry and Applied Sciences for Food Security, Environmental Safety and Sustainable Development (GIAFAS-2021)”

biological yield as compared to wheat sown in conventional tillage conditions with no residue. Therefore, it is concluded that different residue management and tillage systems have more influence on the performance and productivity of different varietal genotypes of wheat.

Keywords: *Wheat Yield, Performance, Tillage System, Residue, Varieties, Productivity*

The wisdom for dual role of rural women in household and papad making enterprise for their livelihood in bihar state

Rambha kumari * & Dr. Shishir kala **

¹ *Deptt. of F.R.M., College of Community Science, G.B. Pant University of Agriculture & Technology, Pantnagar, Distt. U. S Nagar, Uttrakhand- 263145.*

² *Deptt. of F.R.M., College of Community Science, Dr. R.P.C.A.U., Pusa, Samastipur, Bihar. 848125*

ABSTRACT

The role of women is crucial for the overall development i.e. nutritional, economic and educational upliftment of their family as now a days women economically contribute in their family income. In traditional India, most of the women were homebound but the scenario is gradually changing and now women had entered in almost all the field. They can prove the statement given by Jawahar Lal Nehru, the 1st Prime Minister of our nation i.e. “when a woman moves forward, the family moves, the village moves and the nation moves”. Women constitute one third of our country’s economically active population particularly in the unorganised sector specifically in the agrarian sector. (S.N Goswami, *et al.*). The employment opportunities in rural areas are low because of the fact that the agriculture is of seasonal in nature result in migration of rural people especially the women in other areas like microenterprise, small scale industries etc. for seeking their livelihood. Women play an important role in the economic welfare of their family where lots of women are engaged in microenterprise for their livelihood security. In general women do all these activities just for household purpose, without keeping the financial bearing in mind. She manages household activities as well as enterprise activities properly. Besides women perform dual activities is of two folds- one on the domestic front and the other on the economic front. This study was conducted in Muzaffarpur district of Bihar. Two microenterprises namely Papad Making Enterprise (PME) and Agarbatti Making Enterprise (AME), situated at Rambagh and Kalibadi road respectively. In this enterprise approximately 200 women were engaged. A forty respondents were selected from each Papad Making Enterprise and Agarbatti Making Enterprise. Thus the total sample size was 80 respondents and applied interview method for getting studied. In papad making enterprise approximately 130 women were engaged and I taken only 40 respondents for getting studied. In this enterprise women have lots of work related to enterprise and their home. The data pertaining to the involvement of women in papad making enterprise, indicated that maximum of respondents (62.5%) were involving for carry out ingredients by others i.e their family members, followed by 25 percent respondents were working herself and remaining 12.5 percent respondents were engaged with their husband. For dough making majority of respondents (75%) were involving by others and remaining 25 percent respondents were involving by herself. While a large number of respondents (50%) were using 1 to 3 hours for papad rolling followed by the women devoted 1 hour (37.5%) and remaining women devoted 3 to 6 hours (12.5%). As it in the other hand household activities a large number of respondents (37.5%) were giving 1-3 hours for cooking activity and remaining 26.5 percent were giving only 1 hour for it. The data related to washing cloth a maximum of respondents (50%) were devoting 1 hour for cleaning their cloth followed by the women (37.5%) were giving 1 to 3 and remaining women (12.5%) were giving 3 to 6 hours for it. A maximum of respondents (55%) were giving 1 hour for their child care followed by the 45 percent women used to give 1 to 3 hours and remaining 25 percent women were giving 3 to 6 hours for this. On personal care, majority of respondents (45%) were using 3 to 6 hours followed by the respondents (30%) used 1 to 3 hours and 25 percent respondents used to give only 1 hour for it. It was noted that f - value was significant and positive, hence it can be concluded that the women’s participation in time management practices in household activities influenced by the independent variables. The findings of the study provide relevant information related with Socio- personal and psychological characteristics of selected women entrepreneur and their management practices needs. In general women do all these activities just for household purpose, without keeping the financial bearing in mind. She manages household activities as well as enterprise activities properly. Through this study identified management need of women in household and enterprise activity so that they can be able to make identity herself, economic empowerment, taking decision independently, and increase self confidence. Though, through microenterprises women can earn money for livelihood and improve their living standard of family members.

Key Words: *Livelihood, Household, Microenterprise, Upliftment.*

Bael-a medicinal tree & its conservation an dreligious value in india

K.P.Dwivedi,R.P.Bain,andA.K.Tomar

¹*Jawaharlal Nehru Krishi Vishwa Vidyalaya, Jabalpur, (M P)*

ABSTRACT

Bael,Aegle marmelos(Linn.)Correa ex Roxb,belongs to family Rutacea.A tree of India origin is known from pre-historic time. It has a great mythological significance for every Hindus. Utilization of bad in day-to-day life has great nutritional, environmental as well as commercial importance. Every part of the plant,such as bark,leaves,fruit,seeds and below ground part like roots are effective remedies to control diarrhea,dysentery,constipation,pepticulcer and respiratory infection. It has important medicinal properties like antidiabetic, antimicrobial ,antipyretic ,analgesic ,cardio protective,antispermatogenic,anti-inflammatory, anticancer and radioprotective.This medicinal tree is also ecofriendly climate purifier, emitting greater percentage of oxygen in sunlight as comptated to other plants and absorbing poisonous gases from atmosphere and making it inert or natural. Bael tree is also considered under the category of “fragrant species” whose flowers and volatile vapours neutralize bad smell of petrified organic matter or decaying refuge, This is a very important tree and so, to conserve it, people started regarding it as scared. Looking upon wide prospects and potential of this scared tree, it is good to cultivate it on a large scale ,especially on wasteland, community land, farm boundaries and in agro forestry systems. This tree will not only assist in medicinally but also in meeting the various requirement of the farmers and villagers e.g. nutrition, top feed, fuel wood and raw material for pharmaceutical.Systematic and scientific research is required to explore the maximum potential of this under utilized plant.This will help in financial upliftment of poor and landless farmers.

Key words: Medicinal Forestry ,Medicinal plants, Aegle marmelos, Religious value.

APPLICATION OF INFORMATION AND COMMUNICATION TECHNOLOGY IN AGRICULTURE

Gargi Paliwal¹; Dr.D.K. Singh²; Samarjeet Singh³

¹*Agricultural Communication Govind Ballabh Pant University of Agriculture & Technology, Pantnagar-263145,Uttarakhand., India*

^{2,3} *Department of Agricultural Extension & Communication; Sardar Vallabhai Patel University of Agriculture & Technology, Meerut-250110, U.P., India*

ABSTRACT

Agriculture plays an important role in the social and economic development in our country and is considered as the main contributor to economic growth and stability. Information and Communication Technology is an emerging field which focuses on the enhancement of agricultural and rural development and is defined as technologies that are used to interlink information technology devices such as personal computer, slide projectors, television, digital camera, with communication technologies such as telephone and the telecommunication networks which enable the users to store, transmit, access and manipulate information. Application of new information sources is a crucial requirement for the achievement of sustainable development of the farming system. National e-Governance plan indicated that the typical services envisaged in Agriculture as a Mission Mode Projects (MMP) to provide information to the farmers on government schemes, crop management, seeds, fertilizers, pesticides, weather and marketing of agricultural produce. Projects such as Pusa-Krishi, KisanSarathi, launched by ICAR and ASHA in Assam, e-Krishi in Kerala, and KISSAN in Karnataka etc. have been initiated by the Department of Agriculture and Cooperation, Government of India. In most of the ICT initiatives information flow was one-way that resulted in limited scope for interaction between farmers and scientists but Projects such as Digital Green, Village Resource Centre, e-Arik, e-Sagu, e-seva, provides opportunities for interaction among farmers and experts. ICT are going to play greater role in private sector such as agribusiness and market intelligence. ICT helps in enabling farmers to make better decisions about future crops and commodities through accurate and reliable information that reaches the farmers at the right time.

Keywords: ICT, Application.

APPLICATION OF INFORMATION AND COMMUNICATION TECHNOLOGY IN AGRICULTURE

Gargi Paliwal¹; Dr.D.K. Singh²; Samarjeet Singh³

¹*Agricultural Communication; Govind Ballabh Pant University of Agriculture & Technology, Pantnagar-263145, Uttarakhand., India*

²*Department of Agricultural Extension & Communication); Sardar Vallabhai Patel University of Agriculture & Technology, Meerut-250110, U.P., India*

³*Department of Agricultural Extension & Communication); Sardar Vallabhai Patel University of Agriculture & Technology, Meerut-250110, U.P., India*

ABSTRACT

Agriculture plays an important role in the social and economic development in our country and is considered as the main contributor to economic growth and stability. Information and Communication Technology is an emerging field which focuses on the enhancement of agricultural and rural development and is defined as technologies that are used to interlink information technology devices such as personal computer, slide projectors, television, digital camera, with communication technologies such as telephone and the telecommunication networks which enable the users to store, transmit, access and manipulate information. Application of new information sources is a crucial requirement for the achievement of sustainable development of the farming system. National e-Governance plan indicated that the typical services envisaged in Agriculture as a Mission Mode Projects (MMP) to provide information to the farmers on government schemes, crop management, seeds, fertilizers, pesticides, weather and marketing of agricultural produce. Projects such as Pusa-Krishi, KisanSarathi, launched by ICAR and ASHA in Assam, e-Krishi in Kerala, and KISSAN in Karnataka etc. have been initiated by the Department of Agriculture and Cooperation, Government of India. In most of the ICT initiatives information flow was one-way that resulted in limited scope for interaction between farmers and scientists but Projects such as Digital Green, Village Resource Centre, e-Arik, e-Sagu, e-seva, provides opportunities for interaction among farmers and experts. ICT are going to play greater role in private sector such as agribusiness and market intelligence. ICT helps in enabling farmers to make better decisions about future crops and commodities through accurate and reliable information that reaches the farmers at the right time.

Keywords: ICT, Application.

Present Status, Problem and Prospect of Duck Farming in Kolhan Region of Jharkhand

Pankaj Seth¹, Sushma Lalita Baxla² and Jagarnath Oraon³

¹*Krishi Vigyan Kendra, Saraikela-Kharsawan, Birsa Agricultural University, Ranchi -834006 (Jharkhand), India*

²*Krishi Vigyan Kendra, Garhwa, Birsa Agricultural University, Ranchi - 834006 (Jharkhand), India*

³*Director Extension Education, Birsa Agricultural University, Ranchi -834006 (Jharkhand), India*

ABSTRACT

Indigenous ducks are still preferred by the farmers and proved to be a sustainable livelihood preposition for several poor rural farmers. The study was carried out to know the present status, existing production system of duck and assess the potentiality of duck rearing in two districts purposively East Singhbhum and Saraikela-Kharsawan in Kolhan region of Jharkhand. The data were collected using semi structure interview schedule from 160 farmers selected from four blocks randomly Potka and Patamda of East Singhbhum, Gamharia and Kharsawan of Saraikela-Kharsawan district respectively. The result revealed that majority of the duck rearing farmers (63.45%) were middle aged and 25 per cent farmers were illiterate. Most of the farmers (72.10 %) reared *desi* duck and average flock size per household was found 15.54. The majority of farm women (67.23%) were responsible for duck rearing. It was observed that farmers reared duck in scavenging (58.40 %) and semi-Scavenging system (41.60%) respectively. The 54.78 per cent farmers have used wood/bamboo, plastic net and tin for construction of duck house and 32.24 per cent farmers used bedding materials for their duck house. All duck rearing farmers used kitchen waste, broken rice and rice husk as feeding materials for duck. The 36.37 per cent farmers have provided on an average of 125.65g supplemental feed to each duck/day and cost of the feed was Rs. 1.20/duck/day. Most of the respondent farmers (68.35%) have provided feed to their ducks twice a day. The result showed that age and weight of duck at maturity were 181.6 days and 1.56 kg respectively. The average egg production/duck/year and average weight of egg were found 118.5 numbers and 65.7g respectively. Most of the farmers (56.78%) incubated duck egg under broody hen and they have got 76.63 per cent hatchability on set eggs. The majority of the farmers (57.21%) mentioned that most prevalent disease of duck was cholera and their duck mortality was 17.29%. The respondent farmers (62.89%) farmers controlled their duck disease with medication and only 34 per cent farmers were used vaccine to prevent

3rd International Conference on “Global Initiative in Agricultural, Forestry and Applied Sciences for Food Security, Environmental Safety and Sustainable Development (GIAFAS-2021)”

duck disease. Majority of the farmers (56.34%) incubating duck eggs for ducklings and about 63 per cent farmers purchased duckling by Rs. 35-40 from organized duck farm and 58 per cent farmers were sold adult duck by Rs. 325-350 in local market. Majority of the farmers (64.26%) have stated that the duck farming is increasing day by day and motivated to convert in to improved duck farming and about 48.28 per cent duck farmers have stated that they have started rearing of Khaki Campbell, White Pekin and Indian Runner duck breeds in their farm. It was concluded that scientific duck rearing knowledge and adoption of the farmers such as breeding, feeding, housing, prevention and control of diseases are not satisfactory in the study area. Introducing of improved duck breeds/varieties, capacity building and skill training to duck farmers, ensuring vaccination to ducks, financial and technical support to the farmers could increase the duck rearing practices with doubling farmers’ income and employment to youth, rural women and the small-holder marginal farmers.

Key words: Problem, Prospects, Duck Farming, Semi-Scavenging System, Jharkhand

The modernization Pumped hydro Energy Storage small Hydro Power plant

Ekta Sharma¹, Shishir Kumar Kaushal² and Ratnakiran Wankhade³

¹*Department of Aeronautical Engineering Feroze Gandhi Institute of Engineering and Technology, Raebareli, Uttar Pradesh -229001*

²*Department of Applied science and Humanities, Feroze Gandhi Institute of Engineering and Technology, Raebareli, Uttar Pradesh -229001*

³*Department of Farm Machinery and Power Engineering, G. B Pant University, Pantnagar, (Uttarakhand)*

ABSTRACT

The pumped hydro energy storage (PHES) is a well-established and commercially-acceptable technology for utility-scale electricity storage and has been used since as early as the 1890s. Pumped hydroelectric storage facilities store energy in the form of water in an upper reservoir, pumped from another reservoir at a lower elevation. In this time high electricity demand in India so much. Hydro power is not only a renewable and sustainable energy source, but its flexibility and storage capacity also make it possible to improve grid stability and to support the deployment of other intermittent renewable energy sources such as wind and solar energy, a demand for the resettlement of old small hydro power plants are emerging globally. turbine design are required to enhance plant performance and flexibility and new strategies for optimizing storage capacity and for maximizing plant profitability in the deregulated energy market. This technology has again emerged as an economically and technologically acceptable option for peak load shaving and wind and solar energy storage for power quality assurance. The present study aims at reviewing the existing modernization PHES capacities, technological development, and hybrid systems (wind-hydro, solar pv-hydro, and wind-pv-hydro) and recommending the best possible options. The review explores that PHES is the most suitable technology for small sovereign island grids and massive energy storage, where the energy efficiency of PHES varies in practice between 70% and 80% with some claiming up to 95%. Around the world, PHES size mostly nestles in the range of 1000–1500 MW, being as large as 2000–3000 MW. On the other hand, photovoltaic based pumped storage systems have been used for very small scale (load of few houses) only.

Keywords: *Pumped hydroelectric systems, Solar energy, Wind-hydro energy storage, Photovoltaic-hydro energy storage, Seawater pumped storage.*

Effect of GA₃ on flower yield and quality of different varieties of perennial Chrysanthemum

Dipmala P. kedar* , Dipali Chatse, Dr. D. M. Panchbhai

Section. of Horticulture, Nagpur , Dr. Panjabrao Deshmukh Krishi Vidyapeeth, Akola (India)

ABSTRACT

A field experiment was conducted for observing the effect of GA₃ spray at 30th and 60th days after transplanting on yield and quality of four varieties of perennial chrysanthemum viz, Sonali Tara, Shubhra, Pandhri Rewadi, Piwadi

3rd International Conference on “Global Initiative in Agricultural, Forestry and Applied Sciences for Food Security, Environmental Safety and Sustainable Development (GIAFAS-2021)”

rewadi. Application of GA₃ 150 ppm enhanced number of flower per plant obtained in shubhra with GA₃ 150 ppm and Yield of flower per plant (g), Yield flower per plot (kg) and yield of flower per ha. (q) in Piwadi Rewadi with GA₃ 150 ppm and also Diameter of fully opened flower (cm) and weight of fully opened flower (g), Diameter of flower disc (cm), Shelf life of flower (days) in variety of Piwadi Rewadi .

Key words- Chrysanthemum, GA₃, Different varieties, Yield and quality

Assessment of the genetic variability for resistant starch content and its association with viscosity parameters in rice

Neha Singh^{a,b}, Haritha Bollinedi^{a*}, Kusuma Kumari Panda^b, Gopala Krishnan S, Vinod KK, Bhowmick PK, Nagarajan M, Ellur RK & Singh AK

^aDivision of Genetics, Indian Agricultural Research Institute (ICAR-IARI), New Delhi 110012, ^bAmity Institute of Biotechnology, Amity University, Noida 201313, U.P.

ABSTRACT

Purpose

Resistant starch has evolved as a new bud in the field of nutritional science and it has been recognized as a distinctive starch type due to its slow/incomplete digestion which doesn't contribute to blood sugar spike and act as a matrix for fermentation by helping micro biome of human gut to grow. Rice which is one of the most important staple crop and rich source of dietary energy in most of the Asian countries including India contains digestible starch and indigestible resistant starch (RS). Resistant starch when consumed in right proportion increases satiety and reduces calorie intake and so is beneficial in various diseases such as diabetes, hypertension and obesity. In present investigation, we analysed a set of 192 rice germplasm accessions including land races and popular varieties for their amylose content, resistant starch content and viscosity parameters to find out the accessions having high resistant starch content and its association with viscosity parameters.

Methods

A set of landraces and popular rice varieties were analysed for apparent amylose content (AAC) and RS content. AAC was determined using a colorimetric assay (Juliano et al 1981) while RS content was determined using Megazyme Resistant Starch Assay Kit (AOAC Method. 2002.02) with few modifications. Viscosity parameters were analyzed using Rapid Visco Analyzer (RVA) from Perten Instruments.

Results

The minimum and maximum values of AAC were 9.33% (Super Basmati) and 36.33% (Selected Sabarmati) respectively with a mean value of 25.60. The RS content was found to be ranging from as low as 0.06% (Jhulhat) to as high as 5.45% (HUR 105) with a mean value of 2.29.

Conclusions

The results of the study indicate the extent of genetic variability in rice germplasm for the starch composition, starch digestibility and viscoelasticity traits in the Indian rice germplasm. The high resistant starch accessions identified here can be utilized in the development of diabetic friendly low Glycaemic Index rice varieties.

Key words: Resistant Starch (RS), Apparent Amylose Content (AAC), Landraces.

Synthesis of azomethines and β -lactams of aza heterocycles and antifungal evaluation against *Rhizoctonia solani*

Diksha Verma^{*a}, Sunita Sharma^b, Tanvi Sahni^a, Amanpreet Kaur^a and Sukhmanpreet Kaur^a

Department of Chemistry, Department of Plant Breeding and Genetics, Punjab Agricultural University, Ludhiana-141004, India

ABSTRACT

Pathogenic attack of fungi on agricultural crops is one of the most serious challenges faced by agriculturists. As the demand of food is increasing, attack of fungal pathogens on crops is also intensifying that has been deteriorating the crop yield and quality. To control this, various fungicides are used among which carbendazim and mancozeb plays

3rd International Conference on “Global Initiative in Agricultural, Forestry and Applied Sciences for Food Security, Environmental Safety and Sustainable Development (GIAFAS-2021)”

significant role due to the presence of active nuclei, nitrogen, which may disrupt the cell wall synthesis via hydrogen bond formation with cell membrane active sites. Due to this, almost 60% drugs contain nitrogen heterocycle as a part of the ring. In light of importance of nitrogen containing moieties, present work was done to structurally modify the aza heterocycles to yield azomethines and β -lactams by carrying out reaction of 4-amino-1,2,4-triazole and 4-amino antipyrine with veratraldehyde and iso vanillin to yield azomethine derivatives followed by cyclization of (CH=N) moiety using chloroacetyl chloride and triethylamine to get four membered β -lactam ring. The synthesized compounds were screened for their antifungal potential against maize pathogenic strain *Rhizoctonia solani* using carbendazim as standard. It was observed that azomethine derivative of 4-amino-1,2,4-triazole and veratraldehyde was most effective among all the compounds with ED₅₀ 11.02 which is at par with standard carbendazim with ED₅₀ 10.00. None of the compounds showed ED₅₀ less than that of standard. The synthesized compounds were also found to be significantly different among themselves at all the concentrations.

Development of Papaya Flavoured Synbiotic Shrikhand

N. A. Suryawanshi, S. S. Ramod, Y. N. Patil, V. B. Kadav and V. S. Dandekar

Department of Animal Husbandry and Dairy Science, DBSKKV, College of Agriculture, Dapoli. Dist- Ratnagiri (MS) 415 712

ABSTRACT

In present study shrikhand was prepared from buffalo milk and blended with fresh papaya pulp. Dextrine was added @ 1.5, 2.0 and 2.5 per cent (of milk on w/w basis) as prebiotic and Lactobacillus casei was added @ 1.5 per cent as probiotic and fresh papaya pulp were added @ 10, 20 and 30 per cent (of chakka) in all treatments. The results of present study, it may be concluded that dextrine and papaya pulp could be successfully utilized for preparation of synbiotic papaya shrikhand. The most acceptable quality of synbiotic papaya shrikhand can be manufactured by using 2.0 per cent dextrine and 20 per cent papaya pulp. On the basis of sensory and microbial evaluation of most acceptable level, it was observed that product fit for consumption up to 10th day under refrigerated condition at 5 to 70C temperature.

Key words: - Synbiotic, shrikhand, papaya pulp.

Soil and Water Characteristics of North Bihar Fish Ponds in relation to Fish Production

S. S. Prasad, Shankar Jha, Sanjay Kumar Singh, S. P. Singh and Sudhir Das

Dr. Rajendra Prasad Central Agricultural University, Pusa, Samastipur, Bihar- 848 125

ABSTRACT

Soil and water characteristics of fish ponds from four cluster villages of Kanti and Motipur block of Muzaffarpur district and Sheohar and Piprahi block of Sheohar district north Bihar were studied in relation to fish production during 2010 to 2012. Soil and water samples from 18 ponds were collected and analysed using standard procedures. Average soil pH, electrical conductivity (d S/m) and organic carbon were found in the range of 7.5 to 8.3, 0.24 to 0.47 and 0.39 to 0.61, respectively. Among available soil nutrient, nitrogen, phosphorus and potassium were varies from 8.6 to 10.2, 1.51 to 3.12 and 10.2 to 14.6 mg/100 g, respectively. All metallic micronutrient (Fe, Cu, Mn & Zn) were found in a significantly higher range. Dissolved oxygen in pond water were found slightly less than the prescribed criteria of 5ppm with slightly alkaline reaction in all ponds. Total dissolved solid (ppm) recorded in the range of 238.46 to 388.64 and phosphorus (ppm) in the tune of 0.042 to 0.062. Average fish production were recorded 1.29, 1.08, 1.58 and 1.43 t/ha, respectively from Kanti, Motipur, Sheohar and Piprahi cluster. Results revealed that the soil and water characteristics of fish ponds greatly affect the fish productivity in north Bihar.

3rd International Conference on “Global Initiative in Agricultural, Forestry and Applied Sciences for Food Security, Environmental Safety and Sustainable Development (GIAFAS-2021)”

Status of sheath blight and sources of resistance in rice landraces

Jameel Akhtar^{1*}, Ravinder Pal Singh¹, B R Meena¹ Pardeep Kumar¹, Rakesh Singh² VC Chalam¹ and Kuldeep Singh³

¹*Division of Plant Quarantine, ICAR-National Bureau of Plant Genetic Resources, New Delhi, INDIA*

²*Division of Genomic Resources, ICAR-National Bureau of Plant Genetic Resources, New Delhi, INDIA*

³*International Crop Research Institute for Semi-Arid Tropics, Patancheru, Telangana*

Rice (*Oryza sativa* L.) is one of the most important and popular food crops of India and the world occupying 43.77 million hectares and production of 169.14 million ton with average productivity of 3.86 t ha⁻¹ in India and 166 million hectares with global production of 750 million ton during 2017-18. It provides coverage for more than two-third of the country's population and also a source of income for millions of rural households. Since it is cultivated in different ecologies and climatic conditions, the crop production worldwide is affected by varieties of biotic and abiotic stresses. Among biotic stresses, sheath blight is more serious problem in rice cultivation. Sheath blight is one of the most devastating diseases of rice worldwide caused by soil borne fungal basidiomycetous necrotrophic pathogen, *Rhizoctonia solani* Kuhn; Teleomorph: *Thanatephorus cucumeris* (Frank) Donk, considered as a globally significant one, second-most prevalent to the blast disease. Sheath blight of rice has led to large scale marketable yield losses from last two decades and can cause up to 50% yield loss in infected fields. The resistance sources against this disease are rare and use of chemical fungicides is the only available option which leads to increased cost of cultivation and shows negative impact on environment as well as farm income.

The pathogen is really challenging to manage due to its broad host range infecting plants from ~32 taxonomic families and highly variable genetically and also due to the inability to find any satisfactory level of natural resistance from the available rice germplasm. Some of the QTLs, like qShB-1.1, qShB-1.2 and qShB-1.3 have been mapped in chromosome-1. One of the most challenging aspects is to identify loci conferring resistance to sheath blight. In our preliminary studies under DBT funded ‘Mainstreaming rice landraces diversity in varietal development through genome wide association studies: a model for large scale utilization of gene bank collection of rice’ project, ~500 rice landraces phenotyped under artificial inoculation conditions at the maximum tillering stage with *R. solani* colonized typha pieces, incubation period varied from 3-10 days and relative lesion length ranged from 0-5, 5-10, 10-15 and 15-20 cm in resistance, moderately resistance and moderately susceptible and susceptible lines, respectively. Based on relative lesion height length, 4 accessions viz., RL-3913, RL-737, RL-46, 211 found to be resistant against sheath blight of rice. Further, we have to screen ~2500 more landraces conserved in the National GeneBank, ICAR-NBPGR, New Delhi. against sheath blight.

Some of the landraces such as showed moderately resistant reactions. The identified accessions may be utilized for develop mapping populations to map genomic regions conferring resistance to sheath blight. The reported QTL(s)/gene(s) can also be validated in the identified lines and could be valuable source of resistance rice varietal improvement programme. Identifying QTLs associated with increased resistance to sheath blight is of vital importance for increasing rice yields worldwide and the development of genetic resistance is one of the alternative means to avoid the use of hazardous chemical fungicides. It is also high time to find out some sources of resistance to combat the pathogen for reducing rice yield losses and subsequently to minimize the threat to global food security.

Achievements in Quality Improvement in Temperate Fruit crops through Molecular Approaches

Ikra Manzoor¹, K.M. Bhat¹, A.R. Malik¹ and Usma Jan²

¹*Division of Fruit Science, Faculty of Horticulture, SKUAST-Kashmir, Shalimar*

²*Division of Vegetable Science, Faculty of Horticulture, SKUAST-Kashmir, Shalimar*

ABSTRACT

Conventional methods of fruit breeding for genetic improvement would not be a better option owing to its difficult, expensive and time-consuming breeding techniques. Alternatively, non-conventional breeding methods are more precise for selection of plants carrying genomic regions that are involved in the expression of traits of interest through molecular approaches. With the development and availability of an array of molecular markers and dense molecular genetic maps in temperate fruit crops, molecular approach has become possible for the traits governed by major genes as well as quantitative trait loci(QTL).The success of non-classical breeding depend on many critical factors such as the number of target genes to be transferred, the distance between the target gene and the flanking

3rd International Conference on “Global Initiative in Agricultural, Forestry and Applied Sciences for Food Security, Environmental Safety and Sustainable Development (GIAFAS-2021)”

markers, number of genotypes selected in each breeding generation, the nature of germplasm and the technical options available at the DNA level. The power and efficiency of genotyping are expected to improve with the advent of markers like single nucleotide polymorphisms (SNP). Molecular approach has been used for the improvement of a number of quantitative traits in temperate fruit crops like flesh firmness in apple (*Malus x domestica* Borkh.) governed by ACO ACS genes using Md-ACO-1 and Md-ACS-1 markers, resistance to downy mildew in grapes (*Vitis vinifera* L. subsp. *sativa*) using SSR markers, sugar accumulation in apple (*Malus x domestica* Borkh.) governed by *MdSWEET* genes in cvs ‘K9’ and ‘Shishan’ using SSR and CAPS markers, diversity studies in walnut (*Juglans regia* L.) using ISSR markers, cisgenics in apple (*Malus x domestica* Borkh.) cv. Gala for imparting scab resistance from *Malus floribunda* 821 using (*Vf*) gene, brachytic dwarfism in peach (*Prunus persica* L. Batsch) cv. Nectavantop due to (*Dw*) gene on LG 6 using SNP markers, genome sequencing in almond (*Prunus communis* L.) with 238 Mb genome size and albino colour development in grapes (*Vitis vinifera* L.) governed by (*VvPDS*) gene using the novel CRISPR/Cas9 technology. So, to speed up the breeding process in temperate fruit crops molecular approach can open up new vistas as it can reveal valuable information about genetic makeup and can increase the efficiency of selection in a robust and reliable way.

Keywords: Molecular markers, apple, improvement, temperate, fruit crops.

Post-harvest management for improving shelf life of banana fruit

Abhay Mankar¹, K. Karuna^{2*} and Ruby Rani²

¹Directorate of Extension Education, B. A. U., Sabour, Bhagalpur, Bihar, India

²Department of Horticulture (Fruit & Fruit Tech.) B. A. U., Sabour, Bhagalpur, Bihar, India

ABSTRACT

Banana fruits are liked by the people worldwide because of its multipurpose uses like table purpose, vegetables, beverages, chips, figs, flour, etc. Banana is although a tropical fruit crop but it can be successfully cultivated in subtropical regions. Due to lack of sufficient processing industry, ripening chamber, pre cooling chamber, congenial transportation facility, etc. in India, the post-harvest losses are much higher all over the country. Non availability of above facility to the growing area of banana, it may lack behind in international markets and may cause economic loss to the growers. Lots of work has been done on post-harvest management of banana but growers are not much benefitted. It might be due to lack of training, or extension of technology from lab to farmer’s field. Even though ripening is also one of the important components for best quality banana fruits which will be fetch better price in national and international market. For this purpose, ripening chamber is essential for uniform ripening, firmness of pulp, attractive yellow colour fruits and better quality. Packaging of fruits in different cushioning materials is also beneficial for increasing shelf life of fruits. Different chemicals like calcium chloride or calcium sulphate enhance or retain the fruit firmness which is used by the progressive farmers. It needs to be exploring through extension to other farmers also for better return. Processing industry in the banana growing region may be beneficial to reduce glut in the market. Raw materials may be easily available to the industry.

Analysis of soil samples for different physico-chemical properties in middle IGP of Bihar

Basant Kumar Sharma¹ and M. Shamsul Islam²

1. P.G. Department of Biotechnology, Magadh University, Bodhgaya, Bihar (India) -824234

2. Daudnagar College, Daudnagar, Aurangabad, Bihar (India)-824113

ABSTRACT

In the present endeavour, an attempt has been made to assess the soil status of the farmers’ field. 153 soil samples were collected from the field of 32 farmers during 2015-16 in Kishanganj, Katihar and Purnea districts of Bihar representing the Middle Indo-Gangetic Plains of India. The samples were analysed for different physico-chemical parameters as pH, EC (ds/m), OC(%), N (kg/ha), P (kg/ha) and K (kg/ha). Soil analysis revealed that the soils of Katihar districts were slightly acidic to normal in reaction (pH 5.5-7.6), Purnea; acidic to near normal (pH 4.4-6.5) and Kishanganj; acidic (pH 4.18-4.37). However, the organic carbon content in Kishanganj soils was higher (0.50-0.70) as compared to Purnea (0.30-0.50) and Katihar (0.26-0.48) soils. Nitrogen content was in medium range in all the districts, where as the phosphorus content in katihar and Kishanganj soils were medium (15.27 to 18.28 kg/ha), but it was high in Purnea district (28.96 kg P/ha). The potassium content was medium in all the soils of all three districts and varied from 161 kg/ha in Kishanganj to 219 kg/ha in Katihar.

Keywords: Soil samples, Organic carbon, Phosphorus, Nitrogen, Potassium, Soil nutrients.

3rd International Conference on “Global Initiative in Agricultural, Forestry and Applied Sciences for Food Security, Environmental Safety and Sustainable Development (GIAFAS-2021)”

Forest Fire Management: A review

Ranjeet Kumar, Richa Sharma, Krishna Kumari and Sangeeta Verma

Himalayan Forest Research Institute, Panthaghathi, Shimla, H.P., India-171013

ABSTRACT

Forest fire is considered as a good servant and an evil master. The main cause of the forest fire is anthropogenic in nature. The climatic variability and global warming have also triggered the events of forest fires in recent years. Every year millions of hectares of the world forests is damaged by forest fire. The ground fire, surface fire and crown fire are three types of forest fire found in the forests.

As per Forest Survey of India data on the website, 37059 fire incidences were detected during 2018 by using MODIS (Moderate Resolution Imaging Spectro- Radiometer) sensor data. As per FSI technical information series of 2020 the area of 11,094 km² (1.56%) was affected by forest fires.

The forest fire may cause ecological and economic damage in the forests. Forest fires affect the density and diversity of plants, soil properties and ecosystem services. Forest fire also affect the natural generation of woody species and structure of forests. Forest fires are also responsible for increasing the invasion of invasive alien plant species, soil erosion, fragmentation of habitats and wildlife losses, etc. Sometimes it has also caused the loss of life of human beings.

Forest fires can be reduced by conducting control burning in winter when the temperature is low. The fuel load on the fire prone areas like accumulation of litter, ground organic matter, standing dead trees, grasses and herbaceous plants and cones of pines can be managed to control fire. Sound communication network and strong people participation can be effective mean to manage forest fires. Forest fire can also be prevented by creating awareness among people in the fringe villages of forests by conducting awareness programme on biodiversity conservation and training on prevention and management of forest fires. There is need to improve scientific knowledge on management practices of forest fire.

Keywords: Forest fire, causes, management, plant diversity and natural regeneration.

Effect of Cutting Length and Cutting Diameter on Macropropagation of *Melia composita*

¹Sakeena Gul Niazi*, ²Dinesh Kumar and Ashok Kumar

¹Silviculture and Forest Management Division, Forest Research Institute, Dehradun.

²Silviculture and Forest Management Division, Forest Research Institute, Dehradun.

³Genetics and Tree Propagation Division, Forest Research Institute, Dehradun.

ABSTRACT

Melia composita Willd. belongs to family Meliaceae, a multipurpose, deciduous, fast growing tree indigenous to India, Southeast Asia and Australia. The tree provides high-quality termite and fungus resistant timber for plywood and pulpwood industries. The species is reported to have hard stony seed coat which makes it difficult to germinate without any treatment under the open condition. Vegetative propagation through cuttings are a simple and comparatively less expensive method for clonal multiplication of genetically superior trees. It provides for maximum benefits in terms of wood properties and productivity, as well as production of more uniform raw material for industrial uses. Rooting of cutting is generally influenced by length and diameter of the planted cuttings. Hence, the experiment was performed to assess the suitable size of cutting for the vegetative propagation of *Melia composita*. Collection of the material for cutting preparation was done from trees of superior genotypes at Dehradun during spring season. Shoot cuttings and root cuttings of 4 lengths viz. <5 cm, 5-7.5 cm, 7.5-10 cm, >10 cm and 4 diameter classes viz. <5 mm, 5-7.5 mm, 7.5-10 mm, >10 mm were prepared. The shoot cuttings were planted in Randomised Block Design after treatment with 2000 ppm IBA whereas root cutting was planted without IBA treatment. The highest survival percentage in shoot cuttings were observed in cutting of length more than 10 cm and diameter more than 10 mm.

Keywords: *Melia composita*, Vegetative propagation, Clonal, Shoot cuttings, Root cuttings.

3rd International Conference on “Global Initiative in Agricultural, Forestry and Applied Sciences for Food Security, Environmental Safety and Sustainable Development (GIAFAS-2021)”

Heat induced decreased activity of nitrate reductase and its impact on yield under late sown condition in three genotypes of wheat (*Triticum aestivum* L).

Kamla Jakhmola*, Sobha, Shweta Sahni

School of Agricultural Sciences, Shri Guru Ram Rai University, Patel Nagar (Dehradun), 248001 Uttarakhand

ABSTRACT

Wheat is an important crop of the tropics, being a rabi crop it is adapted to low temperature (18-25), as global temperature is increasing day by day, it seems to be a major problem to the wheat growing area of India and other countries, because wheat is susceptible to terminal heat tolerance. So, heat tolerance study is become very important to maintain wheat productivity to feed the coming population. Present investigation is carried out to study the genetic variability in wheat to heat tolerance and impact of increasing temperature on activity of nitrate reductase enzyme which is an important enzyme of nitrogen metabolism. In the present study variability in nitrate reductase activity, was found amongst the genotypes viz. Lok54, Raj 3765 and HI1544 shown high nitrate reductase enzyme in heat stress, and NR activity is found to be increased in timely sown condition and low at late sown condition. But some tolerant genotype like Lok 54, Raj3765, HI1544 sown high activity as compare to susceptible one. Genotype with high NR activity also sown low heat susceptibility index and high yield in late sown condition. This finding suggests that wheat genotypes are found to differ in their ability to respond to heat, there by tolerance, which could be useful as genetic stock to develop wheat tolerant varieties in breeding programs.

Key Words: Heat Susceptibility Index, Nitrate Reductase, Susceptible, Tolerant

Chromatographic and spectroscopic analysis of heartwood extract of *Pterocarpus* species
Kamal Mishra¹, S. S. Bisht¹, K. K. Pandey¹, Girish Chandra²

¹*Institute of Wood Science and Technology, 18th Cross Malleshwaram, Bangalore - 560003, India*

²*Division of Forestry Statistics, Indian Council of Forestry Research and Education, Dehradun - 248006, India*

ABSTRACT

In this study, chromatographic (TLC and HPLC) and UV-Vis spectroscopic analysis of methanolic extract of *Pterocarpus santalinus* Linn (Red Sanders) heartwood, collected from trees growing in eight different locations was carried out. Usefulness of these techniques for discrimination of some of the commonly occurring species in *Pterocarpus* genus was assessed. TLC fingerprints of methanolic extract of *P. santalinus* revealed distinct spots at R_f 0.94 (light brown), 0.91 (purple), 0.79 (blackish brown), 0.75 (light purple), 0.60 (yellow), 0.51 (dark red) and 0.28 (brownish red) in normal phase. HPLC analysis indicated at least 11 common peaks at retention time (tR) 3.1, 3.5, 8.9, 11.1, 12.8, 13.5, 14.9, 15.7, 17.9, 18.3 and 26.5 (minutes). Heartwood extractive in methanol exhibited a broad UV visible absorption spectrum with consistency in major absorbance peaks at ~280 nm, ~320nm, ~472 nm and ~505 nm. Similarities in chromatographic pattern between the samples from different locations were evaluated using the principal component analysis (PCA). Finally, developed fingerprints of methanolic extract of *P. santalinus* heartwood were compared with those of *Pterocarpus marsupium*, *Pterocarpus soyauxii*, and *Pterocarpus macrocarpus* heartwood extracts. The developed HPLC and TLC fingerprints of *P. santalinus* shows different signature as compared to other *Pterocarpus* species. These developed fingerprints may serve as supplementing tools for identification and evaluation of heartwood of *P. santalinus*.

Keywords: Heartwood, HPLC, *Pterocarpus santalinus* Linn, TLC, UV-Vis spectroscopy.

Effect of different concentrations of kinetin on *in vitro* shoot multiplication of bamboo
Chavan N. S., Chavan N. R., and Kale Sonam S.

Department of Plant Biotechnology, Mahatma Gandhi Mission College of Agricultural Biotechnology, Aurangabad,

ABSTRACT

The shoot multiplication was obtained for nodal explant of *Bambusa balcooa*. The field grown healthy and disease-free bamboo plant was selected from fields. The nodal explants were collected from this mother plant. The explants were cut in suitable size up to 5 cm with node in middle before sterilization. The explant width was 0.5cm. After thoroughly washing with running tap water for 30 minutes and explants explant were subjected to surface sterilization in 1% bavistin for 15 minutes then 1 % tween twenty detergents for 15 minutes followed by 30 seconds wash of 70 % ethanol. Before inoculation 4 washes of sterile double distilled water was given. This experiment was

3rd International Conference on “Global Initiative in Agricultural, Forestry and Applied Sciences for Food Security, Environmental Safety and Sustainable Development (GIAFAS-2021)”

laid down in completely randomized design with 10 treatments (0 to 9 mg/l) of growth hormone kinetin in Murashige and Skoog Media. The explant was inoculated in different kinetin containing media bottles and incubated at 25-degree celcius, 16 hours light and 8 hour dark condition with humidity of 55 %. The inoculated explants were observed for shoot initiation, shoot number, shoot length and number of leaves. It was concluded that treatment T₆, T₇, T₈, T₉ with concentration of 6 mg/l, 7 mg/l, 8 mg/l, and 9 mg/l kinetin in MS media was found best among all other treatment for multiple shoot induction. The experiment was laid out in completely randomized design with 10 treatment of growth hormone kinetin in Murashige and Skoog Media. There were three replications. The sterilization protocol used bavistin, tween twenty and ethanol as disinfectant. This chemical founds suitable for sterilization. Experiment was carried out by inoculating shoot node of bamboo with different concentrations of kinetin (0.0, 1.0, 2.0, 3.0, 4.0, 5.0, 6.0, 7.0, 8.0 and 9.0 mg/L). Shoot node of Bamboo plants were used as an explant in this experiment and inoculate in media containing hormones and incubated for 21 days for multiplication. The inoculated explants were observed for shoot initiation, shoot number, shoot length and number of leaves. It was concluded that treatment T₆, T₇, T₈, T₉ with concentration of 6mg/l, 7mg/l, 8mg/l, and 9mg/l respectively gives the best result among all other treatments.

Association mapping for different phenotypic traits using elite sorghum [*Sorghum bicolor* (L.) Germplasm lines

Chavan N. R., Kale Sonam S., Chavan N. S. and Sonwane V. R.

Department of Plant Biotechnolog, Mahatma Gandhi Mission College of Agricultural Biotechnology, Aurangabad, 431003 MS. INDIA.

ABSTARCT

Association Mapping involves searching for genotype-phenotype correlations among unrelated individuals. Its high resolution is accounted for by the historical recombination accumulated in natural populations. In this study, to identify the marker-trait associations, the phenotyping and genotyping of 20 sorghum accessions was carried out under field and wet lab conditions to generate the data for analysis. The six different phenotypic traits were recorded. They're after the total genomic DNA was extracted from all 20 accession, quantify, diluted to 50ng/ul and used for PCR amplification using eight SSRs. The amplicons were resolved on the 3.5% agarose gel for better resolution and separation. The genotypic data was generated and the associations between marker and traits were identified using t-test in Microsoft excel programme. The analysis revealed that out of eight SSR markers studied, three markers Xtxp278, mSbCIR248, and Xtxp057 were found to be linked markers with two recorded phenotypic traits. Association between Xtxp057on chromosome #06 and seedling length, this time the result is statistically significant because the p- value is well below 0.05. The p-value obtained after analysis was 4.22E-07with percent of total phenotypic variation for a trait that is accounted by the marker (R²) was 27.23 % for Xtxp057. Association of Xtxp278marker on chromosome #08 with seedling length trait, the output obtained for this marker in this study was show association having p-value 4.22E-07 with R² value was 27.23% for 250bp band. The marker MSbCIR248present on chromosome #05 show significant association/ linkage with plant height (PHT) using single marker analysis (SMA) by t-test. The p-value obtained was 0.034252 for trait plant height on 100bp molecular weight bands.

Isolation, Characterization and Genetic Diversity Analysis of *Trichoderma* Isolates Isolated from Gandheli, Aurangabad Region

Kale Sonam S., Chavan N. S., Chavan N. R., and Tapse S.

Department of Plant Biotechnolog, Mahatma Gandhi Mission College of Agricultural Biotechnology, Aurangabad, 431003 MS. INDIA.

ABSTRACT

Trichoderma Species are endophytic plant symbionts that are widely used as seed treatments to control biotic/ abiotic stress and to enhance plant growth and yield. In the present investigation five isolates of *Trichoderma* were isolated from gandheli, Aurangabad region. The total 50 soil samples from 14 different ecological habitats were collected in order to isolate *Trichoderma*. Five different *Trichoderma* isolates were isolated from soil sample and DNA was extracted by using CTAB protocol. Pure cultures were obtained from each isolate. Microscopic characterization of five *Trichoderma* isolates shows the clear conidia and phillids give the confirmation of

3rd International Conference on “Global Initiative in Agricultural, Forestry and Applied Sciences for Food Security, Environmental Safety and Sustainable Development (GIAFAS-2021)”

Trichoderma isolates. The colony color varied from snow white to white, light green, green, to dark green. Genetic diversity based on morphological methods has been diminished due to the use of molecular techniques which have made advances in systematic characterization of *Trichoderma* spp. We studied genetic diversity in five isolates using RAPD markers. Amongst the five isolates tested, the isolate T2, T4 and T5 were grouped in one where as T1 and T3 were differentiate from each other and rest of the isolates. The polymorphism information content (PIC), a measure of gene diversity, varied from 0.26 to 0.56 with an average of 0.44 and was significantly correlated with number of alleles. Gene diversity computed according to Nei (1973) and varied from 0.32 to 0.64 with an average of 0.52. The major allele frequency across five isolates was ranged from 0.40 to 0.60 with the mean major allele frequency was 0.51.

Development of synbiotic lassi by using buffalo milk

S. G. Jagadale, Y. N. Patil, S. S. Ramod, V. B. Kadav and V. S. Dandekar

Department of Animal Husbandry and Dairy Science, DBSKKV, College of Agriculture, Dapoli. Dist- Ratnagiri (MS) 415 712

ABSTRACT

Present study was carried out for developed synbiotic lassi from buffalo milk. Maltodextrin was added @ 1, 1.5, 2% as prebiotic and *Lactobacillus acidophilus* culture was used @ 1.5% in all treatments as probiotic. The results of present study, it may be concluded that maltodextrin could be successfully utilized for manufacture of synbiotic lassi. The most acceptable quality of synbiotic lassi was developed by using 1.5 per cent maltodextrin which contained on an average 22.33, 5.04, 3.16, 13.63, 0.62 and 0.75 per cent total solids, fat, protein, total sugar, ash and titratable acidity, respectively. The production cost of most acceptable synbiotic lassi (T₂) was Rs.55.98/- per lit. On the basis of sensory evaluation for most acceptable level, it is found that product was acceptable up to 8th day under refrigerated condition at 5 to 7 °C temperature.

Key words: Lassi, synbiotic, maltodextrin.

Development of Papaya Flavoured Synbiotic Shrikhand

N. A. Suryawanshi, S. S. Ramod, Y. N. Patil, V. B. Kadav and V. S. Dandekar

Department of Animal Husbandry and Dairy Science, DBSKKV, College of Agriculture, Dapoli. Dist- Ratnagiri (MS) 415 712

ABSTRACT

In present study shrikhand was prepared from buffalo milk and blended with fresh papaya pulp. Dextrine was added @ 1.5, 2.0 and 2.5 per cent (of milk on w/w basis) as prebiotic and *Lactobacillus casei* was added @ 1.5 per cent as probiotic and fresh papaya pulp were added @ 10, 20 and 30 per cent (of chakka) in all treatments. The results of present study, it may be concluded that dextrine and papaya pulp could be successfully utilized for preparation of synbiotic papaya shrikhand. The most acceptable quality of synbiotic papaya shrikhand can be manufactured by using 2.0 per cent dextrine and 20 per cent papaya pulp. On the basis of sensory and microbial evaluation of most acceptable level, it was observed that product fit for consumption up to 10th day under refrigerated condition at 5 to 7°C temperature.

Key words: Synbiotic, shrikhand, papaya pulp.

Preparation of Milk Shake By Using Jaggery and Date (*Phoenix dactylifera* L.)

S. V. Surve, N. T. Chorage, Y. N. Patil, A. J. Mayekar and V. S. Dandekar

Department of Animal Husbandry and Dairy Science, DBSKKV, College of Agriculture, Dapoli. Dist- Ratnagiri (MS) 415 712

ABSTRACT

In the present study the milk shake was prepared from buffalo milk by incorporation of date pulp and jaggery at different levels viz. 5, 10 and 15 per cent date pulp and 4, 5 and 6 per cent jaggery in different combinations. From the result of present study, it may be concluded that date pulp and jaggery could be successfully utilized for preparation of milk shake. The most acceptable quality milk shake can be prepared by using 4 per cent jaggery and 10 per cent date pulp (J₁D₂). The most acceptable quality milk shake (J₁D₂) contained on an average, 25.57 per cent

3rd International Conference on “Global Initiative in Agricultural, Forestry and Applied Sciences for Food Security, Environmental Safety and Sustainable Development (GIAFAS-2021)”

total solids, 6.02 per cent fat, 3.95 per cent protein, 0.881 per cent ash, 14.92 per cent total sugar and 0.163 per cent titratable acidity. The production cost of most acceptable milk shake (J1D2) was ₹ 105.08 per kg.

Key words: - Milk shake, jaggery, date, total solids.

Detection and Isolation of Seed Mycoflora of Lablab bean, Horse gram and Cowpea

Y K Nirgude, R R Rathod, U R Phondekar, R R Kalaskar and U V Mahadkar

Department of Plant Pathology, College of Agriculture, DBSKKV, Dapoli

ABSTRACT

Seed is primary most important input in Agriculture. Healthy seeds produce healthy crops and good yields. Most of the plants grown by seeds. Seed is a important source for producing optimum yield. Seed-borne pathogens may cause losses by deterioration, reducing seed germination, developing seed-borne diseases and seedling mortality at nursery stage. However, knowledge of the about the biology and extent of seed-borne pathogens can help to reduce seed and seedling losses. All of the three seed health testing methods attempted viz., Blotter paper method, Agar plate method and PDA method were found effective to isolate and detect the seed mycoflora of lablab bean, Horse gram and Cowpea. The per cent frequency of association was found maximum in seeds of lablab bean with *Alternaria* spp. followed by *Fusarium* spp. *Aspergillus* spp. *Trichoderma* spp. and *Rhizopus* spp. In seeds of horsegram the per cent frequency of association was found maximum in respect to *Alternaria* spp. and with the seeds of cowpea was found maximum in respect to *Alternaria* spp. followed by *Fusarium* spp. *Rhizopus* spp.

Keywords: Seed, Detection, Isolation, Cowpea, Lablab bean, Horse gram, Blotter paper method, Agar plate method, PDA method, *Alternaria*, *Aspergillus*, *Fusarium*, *Rhizopus*, *Trichoderma*.

GIS Based Decision Support Systems in Agriculture

Mahipal Singh Choudhary

Department of Agronomy, Rajasthan College of Agriculture, Maharana Pratap University of Agriculture and Technology, Udaipur

ABSTRACT

Crop identification and mapping is the need of the hour in today's world. Maps of crop are created by national and international agricultural agencies, and regional agricultural boards to prepare a record of what was grown in certain areas and system will be able to identify age of the crop. The most important activities include identifying the crop types and depict their extent (often measured in acres).

The efficiency and accuracy of data are improved when remote sensing data products and GIS are used. Precision farming, a combination of GIS, GPS receivers, continuous yield sensors, geostatistics and variable rate applicators is an innovative approach to practice of sustainable agriculture. We have tried to study use of GIS (Geography Information System) in agriculture. We also are going to classify the remotely sensed image via satellite and digitize the image. And this digitized image is going to be used to train the existing system so that it can automatically sense the image in future. The main technologies to implement this system are described in detail.

Keywords: GIS, agriculture, satellite image

Molecular Genetic Analysis for YMV Resistance in Blackgram (*Vigna mungo* L. Hepper)

K. R. SARAVANAN*, P. KARTHIKEYAN, S. VENNILA³, and S. SUGANTHI⁴

Department of Genetics and Plant Breeding, Faculty of Agriculture, Annamalai University, Chidambaram,

ABSTRACT

The present investigation on Molecular Genetic Analysis for YMV Resistance in Blackgram was carried out with five families namely P₁'s, P₂'s, F₁'s, F₂'s, F₃'s were performed with the following cross combinations KKM 1×VBN6, KKM 1 × VBN 8, ADT 5 × VBN 6, ADT 5 × VBN 8 was analysed for generation mean and single marker analysis. The result indicated the importance of dominance, dominance × dominance gene interaction in the expression of all the ten traits of interest in the entire cross combinations. It is suggested to postpone the selection to later segregating generations. Seventy progenies of the F₂ of ADT 5 x VBN 8 and two markers were subjected to simple regression approach. The SSR primer CEDG 180 was linked with percentage of disease infection had significant regression coefficient. The marker which is having a strongest relationship can be judged from its

3rd International Conference on “Global Initiative in Agricultural, Forestry and Applied Sciences for Food Security, Environmental Safety and Sustainable Development (GIAFAS-2021)”

adjusted R^2 value which will give the overall percentage of variability of that particular trait explainable by marker. This marker as mapped in the F_2 population of 168 individuals at a map distance of 12.9 cM. The validation of this marker in ten MYMV disease resistant and seven MYMV disease susceptible genotypes has suggested its use in MAB for developing MYMV resistant genotypes in blackgram.

Keywords: Molecular validation, Single marker analysis, SSR markers.

Compatibility of Essential Oils With Entomopathogenic Fungi; A Potential Tool For Insect-Pest Management Renu Pandey*¹ and Sapna Tiwari²

Department of Entomology, G.B. Pant University of Agriculture and Technology, Pantnagar, UK, India

Entomopathogenic fungi (EPF) are used as an alternative to conventional chemical insecticides to manage several insect-pests of agricultural crops. EPF, *Beauveria bassiana* (Balsamo) Vuillemin, and *Metarhizium anisopliae* (Metschnikoff) are important bio-control tools for the use in bio-intensive pest management strategies, owing to their broad host range and relative ease of manipulation. One of the ways to increase the effectiveness of these EPF is by combining them with essential oils and moreover conidial survival can be affected by interaction with agrochemical, environmental factor and or by biopesticides and/or chemical product used to protect plants. Therefore, in vitro compatibility of 6 essential oils (pamarosa, geranium, *pacholi*, eucalyptus, lemon and citronella) with entomopathogenic fungi (*Beauveria bassiana*, *Metarhizium anisopliae*) was tested. Disc diffusion assay method was followed to test the compatibility of essential oils with *B. bassiana* and *M. anisopliae*. Among six oils tested maximum inhibition zone was formed by lemon, (4.53 and 4.83 cm) followed by citronella (4.17 & 4.00), Pamarosa (3.00 & 3.67) & Geranium (1.83 & 3.67 cm) in *B. bassiana* and *M. anisopliae* respectively. Eucalyptus essential oil was the least inhibitory of all tested oils. A Minimum inhibition zone was observed in eucalyptus essential oil (0.77 & 1.30 cm). Whereas *patchouli* oil was found compatible with both the fungi as no inhibition zone was formed. From the study, it was evident that *M. anisopliae* was most susceptible to the essential oils as compared to *B. bassiana*. It was concluded that among all tested essential oils, patchouli oil have the potential to be used in combination with *B. bassiana* as well as *M. anisopliae* as biological control agents.

Key words: Entomopathogenic fungi, essential oils, Disc diffusion assay, Inhibition Zone

Breeding for disease resistance in Bamabara groundnut

Chitti Bharatkumar, Nandini R, Shweta A Mannikeri, Kailash Chandra, Umesh Naik and Pranesh

University of Agricultural Sciences, Dharwad

Bambara groundnut (*Vigna subterranea* L. (Verdc.) termed as a potential crop of future. It is considered to be a completely balanced Food with high protein (25-28%) and quantitatively superior to other pulses due to essential amino acids methionine and lysine. Plant viral diseases inflict serious economic losses in major crops by reducing yield and compromising quality. Among several viral diseases of pulse crops, yellow mosaic virus causes major loss in the yield of the crop. The disease is characterized by faint yellow discoloration of young leaves and bright yellowing of older leaves on Bambara groundnut. Use of disease resistant crop varieties is regarded as an economical and durable method of controlling viral diseases. The present investigation was planned to genetically improve the crop using induced mutation. The seeds were treated with Ethyl Methane Sulphonate concentrations ranging from 0.1 to 0.5 per cent. The M_2 populations of SB-42 were screened for yellow mosaic virus at K-block, University of Agricultural Sciences, Bengaluru, during summer 2014 under natural endemic field condition. From Chi-square test 478 plants as moderately tolerant, 1432 plants as susceptible in the mutants of SB-42 a good fit of 3: 1 (Susceptible: Tolerant) ratio was observed. This suggests that single recessive gene controls tolerance to yellow mosaic virus disease in Bambara groundnut.

3rd International Conference on “Global Initiative in Agricultural, Forestry and Applied Sciences for Food Security, Environmental Safety and Sustainable Development (GIAFAS-2021)”

Effect of Foliar Application of Borex Levels on Growth, Yield and Quality of pomegranate (*Punica Granatum L.*)

OM Prakash Jitarwa¹, Satpal Baloda², Keshar Mal Choudhary³ and sushil⁴

^{1,2,4} CCSHAU, Hisar, Haryana, India

³Department of Agronomy, SKNAU, Jobner, Jaipur, Rajasthan, India

ABSTRACT

A field experiment on “Effect of foliar application of borex Levels on Growth, Yield and Quality of pomegranate (*punica granatum L.*)” was conducted at Horticulture Farm, college of agriculture CCS-HAU Hisar during 2018-19 on loamy sand soil. The experiment consisting of four levels of borex (0, 0.2, 0.4 and 0.6 %). The total 4 treatment combinations were tested in randomized block design with three replications. The Pomegranate variety Ganesh was seven-year-old plant at 5 x 5m spacing. Results revealed that the Foliar application of borex @ 0.4% significantly increased the plant height (m), leaf area (cm), tree spread (m), fruit set %, number of fruits per plant, fruit density, fruit yield, average fruit weight (gm), , fruit length(cm), fruit diameter(cm), total sugar, reducing sugar, non reducing sugar, TSS, aril%, juice%, specific gravity, reduced peel % , fruit cracking % as compared to preceding levels. but statistically at par with 0.6 %. On the basis of experiment results, it may be concluded that foliar application of 0.4% was found significantly better for pomegranate crop in terms of growth yield and quality for farmers of semi arid zone of Haryana.

Keywords: borex, pomegranate, significantly

Impact of different sources of fertilizers on yield and quality parameters of Kinnow mandarin

Monika Yadav, G.S. Rana, R.P.S Dalal, Vijay and Sonu Kumari

Department of Horticulture, College of Agriculture, CCS Haryana Agricultural University, Hisar

ABSTRACT

Integrated nutrient supply management (INM) aims at maintenance or adjustment of soil fertility and of plant nutrient supply to an optimum level for sustaining the desired crop productivity through optimization of benefit from all possible sources of plant nutrients in an integrated manner. Therefore, keeping in view the nutritional requirements, the present study was undertaken to find out the most suitable fertilizer combination and their effect on yield and quality of Kinnow mandarin. The study was carried out at Department of Horticulture, CCSHAU, Hisar in Kinnow mandarin during 2017-18. Soil application of different sources of fertilizers in a randomized block design with three replications treatments were applied in standing crop (10 year old plants). Only soil application is tested and recommended in field crops. The soil treatments included split of recommended dose of fertilizers by different sources. The effect of different sources of nitrogen (N), phosphorus (P) and potassium (K) were observed in terms of number of flowers per twig, fruit set (%), number of fruits per tree, average fruit weight, fruit length and yield. The soil treatments results showed that Ammonium sulphate (2838gm) + DAP(695gm) +KNO₃(230gm) +ZnSO₄ (200gm) proved most effective in improving growth parameters and yield followed by Ammonium sulphate (2975gm) + SSP (2000gm) + KNO₃ (230gm) + ZnSO₄ (200gm) (548.33) and lowest results were observed in Urea (1520gm) +SSP (2000gm) +MOP (175gm). The application of different sources of fertilizers depicted significant response and the control showed minimum effect.

Key word: Kinnow mandarin, fertilizers, yield and quality

Breeding technology changes the landscape of ruminant industry
R.I.A. Raja Khalif

Faculty of Agro Based Industry, University of Malaysia

In recent years, Malaysia is facing a shortfall of animal production from 431,651 in 2015 to 359,200 numbers of goats in 2018. Besides that, according to Animal Breeding Policy, breeding improper and poor reproductions were the main reason for low productivity of livestock in Malaysia. Breeding management is essential to ensure proper management being carried out to optimize production. Farmers in East Coast Malaysia faced difficulties and high loss during rainy season (Nov – Jan) each year. However, reports showed smallholder farmers lack expertise and awareness about standard management of goats. Several factors are known to affect the reproductive performance of

3rd International Conference on “Global Initiative in Agricultural, Forestry and Applied Sciences for Food Security, Environmental Safety and Sustainable Development (GIAFAS-2021)”

farm animals such as the biological type, physical environment and nutrition. In recent years, floods and rainy seasons have impacted animal health, which directly affected the health of new offspring. In fact, climate characteristics such as ambient temperature and rainfall patterns have a massive effect on pasture and food resource availability cycles throughout the year, and on the types of disease and parasite outbreaks among animal populations. High production animals are subject to greater influence by climatic factors, especially those that have increased under tropical conditions, due to high air temperatures and relative humidity. Thus, breeding management in which estrus is synchronized is vital to ensure animals were able to give birth at appropriate period. Applying breeding technology would change the landscape of ruminant industry. Breeding technology varies from semen collection to advanced technology such as cloning.

Keywords: Breeding, Reproductive technology, structured breeding

Molecular Genetic Analysis for YMV Resistance in Blackgram (*Vigna mungo* L. Hepper)

K. R. SARAVANAN*, P. KARTHIKEYAN, S. VENNILA, and S. SUGANTHI

Department of Genetics and Plant Breeding, Faculty of Agriculture, Annamalai University, Chidambaram,

ABSTRACT

The present investigation on Molecular Genetic Analysis for YMV Resistance in Blackgram was carried out with five families namely P₁'s, P₂'s, F₁'s, F₂'s, F₃'s were performed with the following cross combinations KKM 1×VBN6, KKM 1 × VBN 8, ADT 5 × VBN 6, ADT 5 × VBN 8 was analysed for generation mean and single marker analysis. The result indicated the importance of dominance, dominance × dominance gene interaction in the expression of all the ten traits of interest in the entire cross combinations. It is suggested to postpone the selection to later segregating generations. Seventy progenies of the F₂ of ADT 5 x VBN 8 and two markers were subjected to simple regression approach. The SSR primer CEDG 180 was linked with percentage of disease infection had significant regression coefficient. The marker which is having a strongest relationship can be judged from its adjusted R² value which will give the overall percentage of variability of that particular trait explainable by marker. This marker as mapped in the F₂ population of 168 individuals at a map distance of 12.9 cM. The validation of this marker in ten MYMV disease resistant and seven MYMV disease susceptible genotypes has suggested its use in MAB for developing MYMV resistant genotypes in blackgram.

Keywords: Molecular validation, Single marker analysis, SSR markers.

Response of Manures and Inorganic Sources of Nutrient on Growth, Yield and Quality of Chickpea (*Cicer arietinum* L.)

V.K Singh, Ankur Sharma and Shreya Bhatt

Department of Soil Science, Shri Guru Ram Rai University, Dehradun, Uttarakhand

ABSTRACT

The present investigation entitled “Response of Manures and Inorganic Sources of Nutrient on Growth, Yield and Quality of Chickpea (*Cicer arietinum* L.)” was carried out to examine the response of both organic manure and inorganic sources of nutrient, in a single or combined application on growth, yield and quality of chickpea. The field experiment was conducted during winter season, 2019 at Agricultural Research Block of Shri Guru Ram Rai University, Dehradun, Uttarakhand. The experiment was carried out in completely randomized block design with 12 treatments and 3 replications. The investigation revealed that the performance of chickpea was significantly influenced by combined application of manure and inorganic nutrients (NPK). Among all the treatments treatment T₁₂ [FYM (5t/ha) + Neemcake (2t/ha) + 100% RDF] per ha was found best with respect to plant height (59.40 cm), dry matter accumulation per plant (30.66 g), number of pods per plant (50.14), number of seeds or grain per plant (58.13), test weight (25.21 g), grain yield per plant (18.99 g), grain yield (19.35 q per ha), straw yield (26.52 q per ha), harvest index (41.98%), nitrogen content in grain and straw (3.78% & 1.57) and protein content in grain and straw (23.63% & 9.80%). Based on overall performance, it can be concluded that under prevalent climatic conditions of Dehradun region, the combined application of inorganic fertilizer and manures (Integrated Nutrient Management) i.e. application of FYM (5t/ha) + Neemcake (2t/ha) + 100% RDF, can be recommended to an alternative to inorganic fertilizers for efficient nutrients use efficiency and achieving maximum growth, nodulation, grain yield and quality of Chickpea during Rabi season.

3rd International Conference on “Global Initiative in Agricultural, Forestry and Applied Sciences for Food Security, Environmental Safety and Sustainable Development (GIAFAS-2021)”

Impact of Vermicompost based Integrated Nutrient Management on Productivity Enhancement of Broccoli and Soil Properties under Hill Agro-ecosystem of North East India

Popiha Bordoloi

Krishi Vigyan Kendra Ri- Bhoi, ICAR (RC) for NEH Region, Umiam -793103, Meghalaya.

ABSTRACT

The study was conducted at Ri-Bhoi District of Meghalaya in three selected villages to study the impact of vermicompost based integrated nutrient management on productivity enhancement of Broccoli (*Brassica oleracea* var. italica) and its effect on soil nutrient status. The experiment was conducted by following 3 treatments: T1: Vermicompost @ 1.0 t/ha + 50% RDF (RDF: N: P₂O₅: K₂O::120: 80: 60 kg/ha), T2: Vermicompost@ 2.0 t /ha + Lime @ 500kg/ha + 2% urea spray at branching & pod initiation stage, T3: Farmers practice (imbalance fertilizer with N: P₂O₅: K₂O:: 50:20:10 kg/ha) with 5 replications following randomized block design during the year 2017 and 2018. From the results it is revealed that Vermicompost @ 1.0 t/ha + 50% RDF showed significant increase in fruit yield and B.C ratio followed by Vermicompost@ 2.0 t /ha + Lime @ 500kg/ha + 2% urea spray at branching & pod initiation stage and Farmers practice. Moreover, improved soil nutrient status was achieved in T1 followed by T2 and T3 in the soil after the harvest of the crop as compare to the initial stage of soil before the implementation of Treatments.

Keywords: *On Farm Testing, Vermi-compost, INM, Broccoli.*

Evaluation of Potential Biocontrol Bacterial Strains against *Verticillium* Wilt of Cotton

Kamaldeep Kaur, Ashish Vyas

School of Bioengineering and Biosciences, Lovely Professional University, Phagwara, 144411, Punjab, India

ABSTRACT

Cotton is an important cash crop growing at economic level throughout the world. Significant loss of yield occurs by attack of most devastating soil borne pathogenic fungus *Verticillium dahliae*. *in vitro* and *in vivo* study has been conducted to check the efficacy of potential biocontrol bacterial strains against *V. dahliae*. Biocontrol potential of antagonistic isolates was assessed on following criteria: (1) *in vitro* inhibition of *Verticillium dahliae* by Dual culture assay, (2) activities of cell wall degrading enzymes including protease, cellulase, and chitinase. (3) *in vivo* field trials under poly house and natural field conditions. *Pseudomonas aeruginosa*, *Lysinibacillus macroides* and *Bacillus subtilis* have shown most positive *in vitro* antagonism during “Dual Culture Assay”. Seed bacterization with *Pseudomonas aeruginosa* helps to reduced wilt symptoms in natural fields and pot trials more than *Lysinibacillus macroides* followed by *Bacillus subtilis* when compared to control plants (non-bacterized). In both pot experiments and field trials, growth parameters and yield of cotton were significantly higher in seed bacterized plants (*Pseudomonas aeruginosa*.) than non-bacterized seeds(control). Most significant biocontrol efficacy has been recorded in *Pseudomonas aeruginosa* followed by *Lysinibacillus macroides* and *Bacillus subtilis* with 73.6%, 68.5% and 62.5% biocontrol protection percent, respectively under natural field conditions. Results depicts that a combinatorial study of soil solarization and seed treatment with *P. aeruginosa*, *L. macroides* and *Bacillus subtilis* plays a significant role to control wilt disease of cotton in naturally infested fields and improve growth parameters.

Agronomic performance of Lentil under the various weed management strategies

Priyanka Bankoti, Mansi Nautiyal*

School of Agricultural Sciences, Shri Guru Ram Rai University, Dehradun, U.K-248001.

ABSTRACT

The search for cultivation practices that provide increased lentil yield has been recurrent. From this context, the objective of this study was to evaluate the agronomic performance of lentil under the various weed management strategies. One field experiments was conducted in a randomized block design (RBD, with four replications and nine treatments i.e., i.e., quizalofop ethyl @ 55gm, ha as PE, imazethapyr @ 37gm/ha as PE, Chlorimuran ethyl @ 4.5 gm/ha as PPI, pendimethalin @ 1.5 kg as PE, Pendimethalin + Imazethapyr (ready – mix) @ 0.20 kg /ha, Pendimethalin + Imazethapyr (ready – mix) @ 1.5 kg a.i/ha as PE, Pendimethalin @ 1.5 kg/ha as PE + Hand weeding at 40 DAS, Hand weeding thrice at 35, 65 and 90 DAS and control plot. In one year growing season, data

3rd International Conference on “Global Initiative in Agricultural, Forestry and Applied Sciences for Food Security, Environmental Safety and Sustainable Development (GIAFAS-2021)”

were collected on the population of lentil, total yield, and harvest index, population and NPK uptake of weed species. Weed control applications significantly decreased population of weeds after 65 days. The highest grain and straw yield were recorded 1865 kg/ha and 3099 kg/ha respectively during T8 (Hand weeding thrice at 35, 65 and 90 DAS) treatment and the lowest 1380 kg/ha and 2582 kg/ha of grain and straw yield was recorded during T3 (Chlorimuran ethyl @ 4.5 g a.i/ha as pre plant incorporation) treatment. The prominent weeds found in the experimental plot were *Cannabis sativa*, *Cynodon dactylon*, *Chenopodium album* and *Parthenium hysterophorus* etc. and these weeds together constituted 57 percent of the total weed population.

Keywords: *Lentil, Weed, agronomic, population, herbicides*

Plant Growth Promoting Rhizobacteria (Pgpr), Its Importance and Future Perspectives In Agriculture

Shalini Kotiyal and Manjusha Tyagi

Microbiology, SBAS, SGRR, University, Dehradun

ABSTRACT

The public's interest in food habits has shifted dramatically in recent years. People are becoming more aware of their eating habits. People are now aware of the negative consequences of chemical fertilisation and pesticides, as well as their detrimental effects on agricultural output. As a result, there has been a lot of interest in environmentally friendly and sustainable agriculture. By delivering nutrients to plants and regulating biotic and abiotic stress, PGPR promotes productivity and soil fertility. PGPR is involved in nitrogen fixation by symbiotic and free-living rhizobacteria, phosphate solubilization, secret phytohormones, and biocidal metabolites generated by cyanobacteria. It is also utilised to combat plant diseases by producing hydrogen cyanide (HCN), fungal cell wall disintegrating enzymes (eithinase & -1,3-glucanase), and enhancing soil structure and organic matter content. This review article shows the beneficial role of PGPR as biofertilizer, bioinoculator, biocontrol agent and biopesticides over chemical fertilizers. Crop productivity is heavily influenced by environmental conditions. Unprecedented rain, flooding, and drought conditions have harmed agricultural crops in recent years. So, by using bioinoculents, PGPR enhances soil fertility, controls pathogens with biocontrolling agents, and manages biotic and abiotic stress in a variety of ways. Plant biotechnology advancements have made it easier to improve the genetics of both plants and microorganisms. Researchers are now concentrating their efforts on isolating and identifying new microorganisms in the soil, as well as testing their positive effects on plant development and environmentally friendly behaviour.

Performance of wheat (*Triticum aestivum*) varieties under cold stress condition

Garish Chandra*¹, Radha Upadhyay², Kamla Dhyani³ and Sobha Bisht¹

*^{1,2}Department of Seed Science and Technology, ²Agronomy, ³Plant Physiology
School of Agricultural Sciences, SGRR University, Dehradun, India- 248001.*

ABSTRACT

Wheat is playing an outstanding role in feeding the hungry people of the world and an important crop for global food security. In India, wheat is the second most important cereal crop next only to rice and a key crop of the green revolution and post green revolution era. With the changing climatic conditions it is essential to know the performance of wheat crop under stress conditions. The present investigation was conducted during the Rabi season of 2020-2021 at Agricultural Research Farm of Shri Guru Ram Rai University, Dehradun, India to study the performance of wheat varieties under cold stress condition. The experiment was laid out in factorial randomized block design with three replications. The treatments comprises five sowing dates viz. 5th November (T₁), 15th November (T₂), 25th November (T₃), 5 December (T₄) and 15th December (T₅) and two varieties i.e. Unnat PBW 343 (V₁) and PBW 502 (V₂). All agronomic practices like weeding, irrigation, nutrition etc. were used as per the crop requirements. The experimental data show that the plant height (101.4 cm), number of leaves per plant (4.56), plant dry-matter accumulation (189.0 g), number of seed ear⁻¹ (76.30), test weight (39.72 g) and seed yield (43 qha⁻¹) was recorded maximum with 15th November sowing. The variety Unnat PBW 343 performs better than variety PBW 502 with respect to all growth and yield parameters of plants. Based on experimental finding, it can be concluded that under prevalent climatic conditions of Dehradun region, the variety Unnat PBW 343 and 15th November sowing time is best for higher yield of wheat crop as compared to all other treatments.

Keywords: Sowing date, wheat, varieties and yield

3rd International Conference on “Global Initiative in Agricultural, Forestry and Applied Sciences for Food Security, Environmental Safety and Sustainable Development (GIAFAS-2021)”

Ways to encourage participation of farmwomen in family welfare and agricultural development

Nidhi B. Thakur¹ and J. B. Patel²

¹Dept. of Agricultural Economics & Extension, Lovely Professional University, Punjab - 144411

²Dept. of Agricultural Extension and Communication, BACA, AAU, Anand- 388 110

ABSTRACT

This present study entitled “Ways to encourage participation of farmwomen in family welfare and agricultural development” was conducted with a sample of 200 respondents. The ex-post facto research design was used for the research study. The study was carried out in Vadodara district of Gujarat. From these four Talukas were selected on the basis of area under higher cotton production viz, Karjan, Dabhoi, Sinor and Padara. The study was conducted to know several ways to increase participation of farmwomen in agricultural development. The finding is suggested that for the rising the participation of farmwomen in agricultural development, the variables such as occupation, attitude towards agricultural development, social participation, management orientation and attitude towards family welfare should be emphasized. All these five variables predicted 60.10 per cent of the total variation in the extent of participation of farmwomen. It could be concluded that occupation, attitude towards agricultural activities, attitude towards family welfare, information seeking behavior, management orientation and mass media exposure of the respondents were the key variables in exerting considerable direct, indirect and substantial effect on participation of farmwomen in family welfare and agricultural development.

Seed Vigour Tests on Different Cultivars of *Phaseolus Vulgaris* Grown In Chamoli District of Uttarakhand, India

*Sobha and J.S. Chauhan and Kamla Dhayani

School of Agriculture Sciences, Department of Seed Science and Technology SGRR University Dehradun, Uttarakhand, India

Department of Seed Science and Technology, HNB Garhwal University Srinagar Garhwal (A central University)
School of Agriculture Sciences, SGRR University Dehradun, Uttarakhand, India

ABSTRACT

Rajmash (*Phaseolus vulgaris* L. family; fabaceae) is also known as kidney bean/ French bean. It is an annual plant and cultivated throughout the world for their edible beans. The present study was conducted to investigate the effect of seed vigour by germination test of different cultivars of *Phaseolus vulgaris* grown in Chamoli district of Uttarakhand. The experimental material constituted a collection of 7 cultivars (Red small, Red big, Grey, Pink, Yellow, Brown, White) of *Phaseolus vulgaris*. The seed samples of seven cultivars of phaseolus vulgaris were taken from Joshimath, District Chamoli Garhwal Uttarakhand. Morphological aspects viz; seed weight, seed moisture content, seed density and seed diameter were recorded prior to germination test of Phaseolus vulgaris at Seed Testing Laboratory, Department of Seed Science and Technology, H.N.B Garhwal University. Seeds were sterilized with 0.2% sodium hypochlorite solution for germination test. Two replicates of each variety and 25 seed in each replicates were kept in petriplates on whatman filter paper. Petriplates were kept in seed germinator at 25 ± 2°C until final count. The number of normal seedling was counted at the final count, higher the number of normal seedlings greater is the seed vigour. The germination percentage was found 100% in five cultivars, and the other two cultivars showed 96.66% in yellow seeds and 68.33% in Grey cultivar of *Phaseolus vulgaris*. Brown cultivars represented maximum dry weight of root (0.029gm) while minimum dry weight of root has been recorded in yellow cultivar (0.01353gm). Maximum vigour index were recorded in brown cultivar and minimum was recorded in pink cultivar. The findings from the study indicate that brown cultivar of *Phaseolus vulgaris* is highly vigours

Keywords: *Phaseolus vulgaris*, germination, morphological , physiological, Variations.

Open heap compost system: A promising traditional practice for sustainability of Hill-agro-ecosystem in Indian Himalaya’s

***Akshat Uniyal¹, Krishna K Singh² and N S Bisht³**

¹Laboratory of Microbiology, Department of Botany and Microbiology, HNB Garhwal University, Srinagar (G) Uttarakhand-246174, India

²Department of Horticulture, HNB Garhwal University, Srinagar (G), Uttarakhand

³Department of Botany, BGR Campus Pauri, HNB Garhwal University, Srinagar (G), Uttarakhand, India

ABSTRACT

Present investigation depicts assessment of microbial diversity, its succession, plant growth promoting activity and physico-chemical properties of the manure during decomposition of traditional open heap system and its impacts on soil health in Indian Himalayas. Indigenous method of manure preparation was followed for this study; a heap was formed at experimental site using approximately 2 tons live-stock waste. Composite samples of manure and soil were collected to study biotic (Microflora) and abiotic (*i.e* nutrients, pH, EC, Temp.) components. The temperature of heap during decomposition was observed moderate thermophilic. Therefore, it plays a crucial role in favouring growth of a diverse beneficial microbiota. The pH profile of heap was found alkaline throughout the process while the maximum EC (Electric conductance) was observed as $8.72 \pm 0.23 \text{ dS m}^{-1}$. The range of total manure nitrogen and phosphorus was observed from 1.20 ± 0.2 to $1.86 \pm 0.08\%$ and 1.43 ± 0.02 to $1.78 \pm 0.01\%$ respectively. The highest value for potassium was around $3.06 \pm 0.1\%$. A total of 250 dominant bacterial strains belonging to 34 genera were observed to participate in decomposition process in which highest (57.2%) isolates were belongs to *Enterobacteriaceae*, followed by *Pseudomonadaceae*, *Bacillaceae*, *Lactobacillaceae*, *Moraxellaceae*, *Planococcaceae*, *Paenibacillaceae* and *Bukholderiaceae*. In case of Mycoflora, a total of 102 fungal entities belong to 11 genera were isolated from developing in which members of Duteromycetes (*i.e. Aspergillus and Penicillium*) were the most dominated with isolation percentage of 22 and 25, respectively. A total of 27.4% fungi and 18.8% bacteria were found to have phosphate solubilization potential, while 44.1% of fungi were observed for IAA production and 72% bacteria were positive for ammonia production. A high microbial load of beneficial microflora ($278 \times 10^7 \text{ CFU g}^{-1}$ for bacteria and $24 \times 10^5 \text{ CFU g}^{-1}$ for fungi) in developing heap is indicative of promising manure quality. Microbial biomass carbon (MBC) of manure amended soil observed increased against untreated plot and varied from 352 to 434 $\mu\text{g g}^{-1}$ soil in manure amended soil. Study was aimed to investigate the significance of traditional open heap system. Results indicated that it not only facilitates growth of beneficial microbial diversity but also accelerate biodegradability of manure for availability of nutrients to sustain long term fertility of agriculture lands. Physico-chemical and microbiological study of open heap system of traditional composting practice validates that this ages old practice encompasses promising option for low land holder farmers in hilly terrains of Uttarakhand.

Keywords: Plant growth promoting bacteria, Microbial biomass, Phosphate solubilisation, Electric conductance

Applications of biodegradable polymers in food packaging industry

Mohammad Amir^{1#}, Roohi¹, Mohammed Kuddus^{2*#}

¹Protein Research Lab, Department of Bioengineering, Integral University, Lucknow, India

²Department of Biochemistry, University of Hail, Hail, Kingdom of Saudi Arabia

ABSTRACT

Plastics made from fossil fuels are ubiquitous in modern society. From the last 50 years, plastics have been widely used to manufacture packaging materials because of their performance and ease of production. However, the increased use of synthetic packaging films has led to severe ecological problems due to their total non-biodegradability. With the development of food processing industries, there has been a significant increase in the need for petroleum-based packaging materials for use in the food industry. Biopolymers, which breakdown fast in the environment and have characteristics that are similar to conventional polymers, have the potential to be utilized as a solution to the issues caused by plastics. Biodegradable resources can replace conventional plastics as they are completely degradable in nature and give high mechanical properties. PHA, PHB, starch, cellulose, and their derivatives are now extensively used for food packaging. Blending of these biodegradable polymers with other plasticizers increases their mechanical strength, improves their gas barrier qualities, and increases production, making them more cost-effective. Another application of biodegradable materials is that they are also used in edible

3rd International Conference on “Global Initiative in Agricultural, Forestry and Applied Sciences for Food Security, Environmental Safety and Sustainable Development (GIAFAS-2021)”

food packaging. It is estimated that the production of biodegradable materials will reach approximately 2.5 million tonnes in 2025. In terms of value, the biodegradable food packaging market is estimated to reach the mark of 249.5 billion USD in 2025, as compared to 174.7 billion USD in 2020, with a record increase of 7.4% in CAGR.

Keywords: Food packaging; Food packaging material; Biodegradable material; PHB; Food coating; Edible food packaging

Bioinformatics analysis of miRNA and mRNA expression profiles to reveal the key miRNAs and genes in small cell lung cancer

Imteyaz Ahmad Khan¹, Dr. Raziuddin Khan², Dr. Imteyaz Ahmad³, Dr. Mohammad Ahmad Ansari⁴, Dr. Srikant Sharma^{1*}

¹*Department of Biotechnology, Shri Venkateshwara University, Gajraula, Uttar Pradesh, India.*

²*Department of Paramedical Sciences, Al-Falah University, Faridabad, Haryana, India*

³*Department of Biochemistry, Kurukshetra University, Kurukshetra, Haryana, India*

⁴*University College of Medical Sciences (UCMS) & GTB Hospital, University of Delhi, Delhi, India*

ABSTRACT

Small-cell lung cancer (SCLC) is a subtype of lung cancer, accounting for approximately 15% of lung cancers, with early metastasis, high recurrence and poor prognosis. The underlying molecular mechanisms are still unclear and further research is required. The aim of the present study was to identify SCLC-specific biomarkers by evaluating the differential expression of mRNA and microRNA (miRNA) profiling of tissue from patients with SCLC and to compare the normal lung tissue. A non-coding RNA sequence dataset (GSE19945) and transcriptome sequencing dataset (GSE6044) were downloaded from the Gene Expression Omnibus (GEO) database. Using the R limma software package and the GEO2R tool of the GEO, we identified 445 differentially expressed genes (DEGs) and 128 differentially expressed miRNAs (DEmiRNAs). The GO function was significantly enriched for 26 terms, and the Kyoto Encyclopedia of Genes and Genomes (KEGG) database had fifteen enrichment pathways, mainly related to DNA replication, cell cycle, and oocyte meiosis mismatch repair. Cytoscape software was used to generate the protein-protein interaction (PPI) networks to identify the molecular mechanisms of key signalling pathways and cellular activities in SCLC. Using miRNAWalk, we identified 598 target genes of the 13, 80 miRNAs and constructed miRNA target networks. In total, there were eighteen overlapping genes regulated by 28 miRNAs between target genes of the DEmiRNAs and DEGs. The identified hub genes are important because they may be used as biomarkers for prognosis, diagnosis and therapeutic target for SCLC.

Keywords: Small-cell lung cancer, miRNA, biomarkers, Gene Expression Omnibus, protein-protein interaction

Climate change and global warming: impacts and management

Mangi Lal Jat, Madan Nath & Yeragorla Venkata Harikrishna

¹*Department of Extension education, JNKVV, Jabalpur.*

²*Department of Genetics and Plant Breeding, Career Point University, Kota, Rajasthan.*

³*Department of Agril. Extension & Communication, BACA, AAU, Anand.*

Climate change refers to an increase in average temperatures. The climate change, caused by rising emissions of carbon dioxide from factories, vehicles and power stations, will not only affects the atmosphere and the sea but also will alter the geology of the Earth. The effects, or impacts, of climate change may be physical, ecological, social or economic. Evidence of observed climate change includes the instrumental temperature record, rising sea levels, and decreased snow cover in the Northern Hemisphere. Climate can change over period of time ranging from months to thousands or millions of years. The classical time period is 30 years, as defined by the World Meteorological Organization. Climate change reflects a change in the energy balance of the climate system, i.e. changes the relative balance between incoming solar radiation and outgoing infrared radiation from Earth. Global warming is closely associated with a broad spectrum of other climate changes, such as: Increases in the frequency of intense rainfall, decreases in snow cover and sea ice, More frequent and intense heat waves, Rising sea levels, and Widespread ocean acidification. Global warming threatens the planet in a new and unexpected way by triggering earthquakes, tsunamis, avalanches and volcanic eruptions.

Keywords: Climate, Atmosphere, Global, Warming, Rainfall

3rd International Conference on “Global Initiative in Agricultural, Forestry and Applied Sciences for Food Security, Environmental Safety and Sustainable Development (GIAFAS-2021)”

Deciphering the Puzzle of Hypobaric Hypoxia: Proteomics, Prophylaxis and Modelling Approach

Yasmin Ahmad

Defence Institute of Physiology & Allied Sciences (DIPAS), Defence R&D Organization (DRDO), Timarpur, New Delhi-110054

Hypoxia, particularly hypobaric hypoxia, is a multifaceted entity which includes certain molecular, pathophysiological and biochemical aspects. Any single aspect in itself cannot help us elucidate hypobaric hypoxia in its entirety. We observed three crucial lacunae within the existing literature. These include a lack of high-throughput proteomics investigations related to hypobaric hypoxia, supplement with proven efficacy and safety which doesn't involve medical supervision and is not contraindicated in hepatic, renal and cardiac insufficiencies; and a clinically validated rodent model of HAPE without any genetic/pharmacological manipulations. In the present study, the focus was to understand and propose a model for rapid acclimatization based on molecular changes. Then we presented a micronised aqueous suspension of silymarin which is efficacious at low doses in providing antioxidant, anti-inflammatory and hypoxia adaptive vascular responses in addition to being a free radical quencher itself. Silymarin has an excellent safety and efficacy profile in humans. Finally, we create a SD rat model of HAPE which was used to reverse-translate a previously known HAPE marker in humans (SULT1A1) and elucidate the synergistic occurrence of HAPE and inflammation cascades. This is the first radiologically validated rodent HAPE model. In conclusion, we were able to elucidate the molecular, biochemical and patho-physiological aspects of hypobaric hypoxia which were left out by previous studies.

Chilli anthracnose: Spread and its Management

Sushilkumar. S¹, Muthu kumar. R², Bhuvaneswari.V³, Jarman gadi¹, Shivani Kumari¹.

¹*School of Agricultural Sciences and Rural Development, Medziphema, Nagaland University.*

²*Department of Plant Pathology, Tamil Nadu Agricultural University.*

³*Department of Plant Pathology, Assam Agricultural University.*

ABSTRACT

India is the largest producer, consumer and exporter of chillies in the world. In India, per capita consumption is highest for chillies, among the spices produced. It occupies around 30 % of the area shared among major spice crops of the country. Though chillies are grown all over India, chilli occupies an important position as an economic commodity, a major share in Indian economy. Chilli also has uncountable benefits to human health. Fresh green chilli fruits contain more Vitamin C than found in citrus fruits, while red chilli fruits have more Vitamin A content than as found in carrots. The active component of the spice, Capsaicin possesses the antioxidant, anti-mutagenic, anti-carcinogenic and immunosuppressive activities having ability to inhibit bacterial growth and platelet aggregation. Chilli anthracnose, caused by *Colletotrichum* spp, is one of the main causes for post-harvest decay of chilli. It can develop on the field, during long distant transport, cold storage and shelf-life. In conventional agriculture, the whole plant including the fruits, are sprayed with fungicides as a prerequisite for post-harvest control of chilli anthracnose. Due to consumer concerns regarding the use of synthetic fungicides and the demand for safer storage methods, the use of synthetic fungicides is no longer allowed for the post-harvest control of chilli anthracnose. As a result, studies on alternative methods to control post-harvest decay have been developed over the years along with the demand for safer storage methods. In this review, results published within the last decade have been summarized and alternative approaches to synthetic fungicides for post-harvest control of chilli anthracnose were discussed in detail. Overall, the use of natural antimicrobials, biocontrol agents, resistant cultivars and ozone shows promise as treatments that can be adopted on a commercial scale to control post-harvest chilli anthracnose caused by *Colletotrichum* species.

Keywords: Anthracnose, Chilli, Post-harvest, Shelf life.

3rd International Conference on “Global Initiative in Agricultural, Forestry and Applied Sciences for Food Security, Environmental Safety and Sustainable Development (GIAFAS-2021)”

Innovative approach of Agri-business Management in creating opportunities

Smriti Yadav¹, PratisthaYadav²

¹ Department of Agribusiness Management, CSAUA&T, Kanpur 208002 (U.P.) India

² Department of Agronomy, CSAUA&T, Kanpur 208002 (U.P.) India

ABSTRACT

This paper attempts to assess innovative approach of agribusiness taking account of opportunities available in the sector with a view to redefining an attractive strategic option that will provide business environment conducive enough to sustain existing policies along with upcoming demands. SWOT analysis was used to evaluate and redefine an appropriate strategic direction needed for agribusiness to thrive. Agriculture business management is a specialized management programme that focuses on the business aspect of agriculture production and its international trade. It assists the agricultural sector by providing professionals and business leaders. The innovative development of agribusiness requires a focused integrated approach, including solutions in the field of productive interaction between science, the state, and entrepreneurial structures. The increasing penetration rate of new technologies in areas of economic activity creates new opportunities for business development. An innovative approach to doing business requires restructuring the operating model of agricultural enterprises to create opportunities for a flexible response to the emergence of new opportunities and threats to business development. Engaging rural youth in agribusiness has become an important strategy to create employment opportunities. Agribusiness offers promising opportunities to accelerate agricultural sector development, increase food security, address poverty, youth employment and led to economic growth. The focus of the business becomes opportunity identification, discovery of new sources of value and product process innovation that could lead to greater success.

Keywords: Agribusiness, Innovation, Opportunities, Business etc.

Agriculture drone technology: revolutionize agriculture management helps farmers in normal condition as well as in crises

Pratistha Yadav¹, Smriti Yadav²

¹ Department of Agronomy, C.S.A.U.A. &T., Kanpur 208002 (U.P.) India

² Department of Agribusiness Management, C.S.A.U.A. &T., Kanpur 208002 (U.P.) India

ABSTRACT

The present study is about the Automation in agriculture. Artificial Intelligence is the core base of automation, automated technology consumes less time so that time can also be utilized in other agricultural activities efficiently and effectively. Information technology in agriculture has found its path sparking only after information exchange within it. Information here definitely means the data relating to market prices, demand, cultivation ideas and seasonal changes. Information relating to weather is the most important one which saves the farmer from any kind of loss due it. Development of new applications which will ease the work of a farmer is definitely a good sign in the industry. Use of GPS*¹ technology in agriculture in the navigation field global positioning system topped the factors for easy access to places. The same impact or an equally valued impact has been made in agriculture too. Along with GPS, GIS*² also makes its part huge in effective farming. The involvement of these two technologies is for Site-specific farming and Precision farming. Some of the uses of these two technologies are: Farm planning, Field mapping, Soil sampling, Crop scouting, Variable rate applications, Yield mapping etc. The main purpose of GPS in agriculture is to allow the farmers to continue their work even at zero visibility cases. Zero visibility states the difficulties in viewing the farm during rain, darkness, fog, and dust. During these uncontrollable conditions, GPS participates in bring a break-free or interruption less farming. If agriculture is found to be the most innovative field, the statement is possibly due to the mini-chromosomal technology. Use of robots/drones in agriculture is self-explanatory that in this case robots are being used in farming. Their tasks range from processing the seeds to planting. The results are always optimistic due to excess intelligence programmed to the robots. Errors are detected and solved often. Productivity increases due to efficient maintenance and finally, the need for labour is lessened to some extent. No matter how automated the farm is, labour is a factor inevitable in agriculture. Thus, their requirement will be less but the need will exist. This revolutionizes agriculture management will help farmers to large extent in efficient and effective management of crops.

Keywords:*¹ Global Positioning System, *²Geographic Information System, Artificial intelligence, Information, effective, efficient.

3rd International Conference on “Global Initiative in Agricultural, Forestry and Applied Sciences for Food Security, Environmental Safety and Sustainable Development (GIAFAS-2021)”

Pros and cons of biotechnology in agriculture and food security

Mohammed Kuddus

Department of Biochemistry, College of Medicine, University of Hail, Hail, Kingdom of Saudi Arabia

ABSTRACT

Increasing excessive human population around the world created a serious and extensive problem of food crisis. It is estimated that by 2050 we will need a minimum of 70% more food. Also, along with more food we need much better food, as by 2050 most of the people are likely to have mediocre earnings. Agriculture biotechnology can help to resolve this issue by increasing the productivity and quality of the crops and therefore fulfilling our nutrition requirements. There are lot of biotechnology applications used in agriculture to increased yield, insect resistance, drought resistance, herbicide resistance etc. Other benefits include decrease in greenhouse gases as biotechnology reduces post processing, allows growing variety of crops in a small land, and allows mass production of important medicines. However, genetically modified food have future long-term negative effects on the environment and human health. It may have changed the life span, illness process and cognitive capabilities of pests that feed on these plants that could result in a decline in biodiversity. Biodiversity loss could damages the health of our ecosystems and puts food security at threat. We need to be alert regarding health and ecological effects of biotechnology. This presentation will include benefits and risks of biotechnology in agriculture farming and human health.

Keywords: Biotechnology, food crisis, genetically modified food, human health, biodiversity

Interventional study to improve the haemoglobin level using green leafy multigrain flour on anaemic women in Neemuch district (M.P)

Shilpi Verma, P.S.Naruka, S.S.Sarangdevot, C.P.Pachauri and J.P Singh

Krishi Vigyan Kendra, Neemuch

ABSTRACT

Nutritional deficiencies remain with the same burden and nutritional anemia being one of the major concerns in India. Hence it becomes quite evident that alternative strategies should be tried to improve the nutritional anemia and reduce the morbidity associated with it, such as use of locally available, traditional food to increase the bioavailability of iron and to improve the nutritional behavior through nutritional education. Nutritional anaemia is public health issues confronting women. Their adverse effects are likely pronounced during the dry season when green leafy vegetables, rich-sources of iron and provitamin-A are scarce. This study assessed the effect of dried green leafy multigrain flour on anaemia status of women in Neemuch district of M.P. The mean Haemoglobin level of the women in the interventional group before the intervention was 11.33 which increased to 11.96 after the intervention. Similarly, the mean Haemoglobin level of women in the control group before the intervention was 10.95 which remained 10.83 after the intervention. Consumption of green leafy vegetables powder increased mean haemoglobin of the study participants. It had the potential to minimize prevalence of anaemia status of study participants.

Achievements in Quality Improvement in Temperate Fruit crops through Molecular Approaches

Ikra Manzoor¹, K.M.Bhat¹, A.R.Malik¹ and Usma Jan²

¹Division of Fruit Science, Faculty of Horticulture, SKUAST-Kashmir, Shalimar

²Division of Vegetable Science, Faculty of Horticulture, SKUAST-Kashmir, Shalimar

ABSTRACT

Conventional methods of fruit breeding for genetic improvement would not be a better option owing to its difficult, expensive and time-consuming breeding techniques. Alternatively, non-conventional breeding methods are more precise for selection of plants carrying genomic regions that are involved in the expression of traits of interest through molecular approaches. With the development and availability of an array of molecular markers and dense molecular genetic maps in temperate fruit crops, molecular approach has become possible for the traits governed by major genes as well as quantitative trait loci(QTL).The success of non-classical breeding depend on many critical factors such as the number of target genes to be transferred, the distance between the target gene and the flanking markers, number of genotypes selected in each breeding generation, the nature of germplasm and the technical options available at the DNA level. The power and efficiency of genotyping are expected to improve with the advent of markers like single nucleotide polymorphisms(SNP).Molecular approach has been used for the improvement of a

3rd International Conference on “Global Initiative in Agricultural, Forestry and Applied Sciences for Food Security, Environmental Safety and Sustainable Development (GIAFAS-2021)”

number of quantitative traits in temperate fruit crops like flesh firmness in apple (*Malus x domestica* Borkh.) governed by ACO ACS genes using Md-ACO-1 and Md-ACS-1 markers, resistance to downy mildew in grapes (*Vitis vinifera* L. subsp. *sativa*) using SSR markers, sugar accumulation in apple (*Malus x domestica* Borkh.) governed by *MdSWEET* genes in cvs ‘K9’ and ‘Shishan’ using SSR and CAPS markers, diversity studies in walnut (*Juglans regia* L.) using ISSR markers, cisgenics in apple (*Malus x domestica* Borkh.) cv. Gala for imparting scab resistance from *Malus floribunda* 821 using (*Vf*) gene, brachytic dwarfism in peach (*Prunus persica* L. Batsch) cv. Nectavantop due to (*Dw*) gene on LG 6 using SNP markers, genome sequencing in almond (*Prunus communis* L.) with 238 Mb genome size and albino colour development in grapes (*Vitis vinifera* L.) governed by (*VvPDS*) gene using the novel CRISPR/Cas9 technology. So, to speed up the breeding process in temperate fruit crops molecular approach can open up new vistas as it can reveal valuable information about genetic makeup and can increase the efficiency of selection in a robust and reliable way.

Keywords: Molecular markers, apple, improvement, temperate, fruit crops.

Innovative Partnership Framework for Rice Sector

Arun Kumar S

ICAR- Indian Institute of Rice Research, Hyderabad - 500030

Partnership is the one of the approaches envisaged for achieving the country’s committed challenging millennium development goals (MDG) like ensuring food security, reducing rural poverty and improving farm productivity without adverse effects on environment. There is an increasing need to work in partnership and to share knowledge and skills in order to provide locally relevant services that meet the information needs of marginal and smallholder farmers in India. Partnerships based on knowledge sharing between scientists and clientele groups are increasingly needed to advance science and for the implementation of science-based information. This paper explores the conceptual basis for existing and emerging institutional patterns of agricultural research and development in general and rice in particular in the context of partnership approaches to technology development and dissemination. Also, it documents the stakeholder’s perceptions and willingness in the various partnership processes like rice technology development and dissemination. As the number of farmer producer organisations and Agtech start-ups are emerging, innovative partnership framework comprising of various actors with new patterns and networks of partnership with clearly defined roles and responsibilities for rice research and extension leading to possible emergence of a new model for the production, diffusion and use of agricultural technology is formulated. This collaborative relationship consisting of research and development partners from both public and private sector is envisaged to play a significant role among the donor agencies and international research community to produce disruptive partnership outcomes.

Effect of Different Poplar (*Populus deltoides* Bartr.) Clones after eleven years of Plantation in Calciorthents of Bihar.

¹Atul Kumar, ¹Shriman Kumar Patel, ²Vijay Kumar, ³Jeetendra Kumar, ³Ajit Kumar and ³Wajid Hasan

¹Department of Soil Science and Agricultural Chemistry, Bihar Agricultural University, Sabour Bhagalpur-813210

²Krishi Vigyan Kendra, Manji, Saran, Dr. Rajendra Prasad Central Agricultural University, Pusa, Samastipur (Bihar)

³Krishi Vigyan Kendra, Jehanabad, Bihar Agricultural University, Sabour Bhagalpur-813210

ABSTRACT

Poplar trees are becoming extremely important as fast growing species due to the increasing need for wood and decreasing productivity of the lands. The present investigation was conducted in eleven-year-old poplar (*Populus deltoides* Bartr.) plantations established at Krishi Vigyan Kendra, Birouli, Samastipur (Bihar) to find the effect of six promising clones (PP-5, Udai, L-52, L-49, G-48 and L-188) as one of the most important effective factors on soil properties and also to estimate the timber volume of different poplar clones. Clones were planted with 5x4 m spacing in frame of randomized block design with four replications. The soil samples were taken from 0-15 cm and 15-30 cm depth of soils under plantations of different poplar clones and from open (without trees). The results showed that the upper 0-15 cm soil in L-52 poplar clone plot had highest value (6.30 g kg⁻¹ soil) and it was 125% more over control (open). Besides, L-49 had almost similar soil organic carbon status. Hence, the soils under these

3rd International Conference on “Global Initiative in Agricultural, Forestry and Applied Sciences for Food Security, Environmental Safety and Sustainable Development (GIAFAS-2021)”

two plantations have more potentiality for sequestering organic carbon. Irrespective of the soil depths, maximum reduction in PH (0.47 unit) was noticed under the canopy of L-52 followed by L-49 (0.37 unit) and the less change was noticed under L-188 (0.16 unit). Electrical conductivities (EC) under all the poplar plantations were significantly lower as compared to open. Improvement of available macronutrients such as N, P₂O₅ and K₂O, was recorded under all the plantations. Maximum build up was under L-52 followed by L-49 clones. Significant decrease in available S was recorded under Uday, G-48 and L-188, whereas L-52, L49 and PP-5 poplar clones showed significant increase in available S at both the depths of the soil over open condition. Maximum improvement of available micronutrients Fe, Cu, Mn and B was recorded under L-52 followed by L-49 clones. However, available Zn declined under all the plantations at both the depth of the soil except under the clone L-52 in the surface soil. Thus, soil fertility as reflected by soil pH, electrical conductivity, bulk density, soil organic carbon, available macronutrients (N, P and K) and micronutrients (Fe, Cu, Mn, B and S) can be improved by integration of L-52, L-49 and PP-5 clones of poplar (*Populus deltoides*) in silvicultural systems under upland calcareous soil condition, besides meeting the demand of wood for plywood and fuel.

Key words: Agroforestry, micronutrient, Calciorthents.

Application of geo-spatial study for assessment of soil quality index for tea growing soils in Kishanganj district, Bihar

Mamta Kumari, Rajkishore Kumar, B.K. Vimal, Y. K. Singh and Atul Kumar

Department of Soil Science & Agricultural Chemistry, Bihar Agricultural University, Sabour, Bhagalpur-813210

ABSTRACT

Tea (*Camellia Sinensis*) is a major commercial crop in India, China, and Sri Lanka, having originated on the Guizhou Plateau in Southwest China (Han *et al.*, 2007). India is the world's largest producer, and consumer of tea, which accounts for roughly 28 per cent of global production, and 13 per cent of the global trade. Bihar is one of the most tea growing hidden state which have need to explore up to national level. But, because of vagarious climatic constraints like high rainfall, high temperature and severe wind speed which severely devastated the growth and productivity of tea crops. The excessive rainfall has also been brought negative impact to enhanced the excess water availability which hampered the tea plant growth, and growth of new leaves on tea bushes and ultimately leads to deteriorate the quality of tea production.

Thereby, present investigation was carried out entitled on “Application of geo-spatial study for assessment of Soil quality index for tea growing soils in Kishanganj district, Bihar” Thereby, for developed the soil quality indices, data reduction technique like PCA (Principal Component Analysis) was employed after scoring and evaluating the minimum data Set (MDS) to judge the most sensitive indicators for tea growing soils which was given in descending order like available K₂O > DTPA-Mn > specific humidity > microbial biomass carbon > pH. Meanwhile, the highest value of SQI (1.62) was observed in Thakurganj block, and minimum (1.31) was observed in Kochadhamin block. For identification, and delineation of potential tea growing areas, only 8 and 15% areas belong to very low and low potential, respectively because of the evidence of sand dune patches in studied areas after performing the overlay weighted analysis, and rest of the areas covered under medium to high potential. Overall, we can be concluded that among the various soil attributes, available K₂O, soil pH, specific humidity, microbial biomass carbon, DTPA-Mn and acid phosphatase might be act as governing attributes for tea quality for farmers, scientific community, academia and stakeholders, for establish the tea processing industry and boost up the socio-economic status of farmers.

Genomics Tools for Breeding Submergence Tolerance in Rice

Digvijay Singh^{*1}, Satyendra¹, Sweta Sinha² and Mankesh Kumar¹

¹*Department of Plant Breeding and Genetics, Bihar Agricultural University, Sabour, Bhagalpur-813210 (India)*

²*Department of Molecular Biology and Genetic Engineering, Bihar Agricultural University, Sabour, Bhagalpur-813210 (India)*

ABSTRACT

Flooding stress is one of the most frequent environmental stresses constraining rice production, especially in rain-fed lowland areas affecting global food supply and financial security. The intensity of rainfall events is expected to increase under future climate change scenarios, which will greatly impact rice production. Different flooding patterns can cause damage or complete yield loss in rice plants at different stages of growth. This includes (a)

3rd International Conference on “Global Initiative in Agricultural, Forestry and Applied Sciences for Food Security, Environmental Safety and Sustainable Development (GIAFAS-2021)”

complete submergence due to flash flood at vegetative or pre-flowering stages, (b) stagnant flooding of medium-deep water and deepwater or floating rice, and (c) submergence at germination or anaerobic germination. At several Institute, breeding for tolerance to submergence imposed by flash flooding during the vegetative stage has been one of the institute's priority objectives for more than three decades. Several tolerant breeding lines have been developed through conventional breeding; however none of those early varieties has been widely accepted by farmers. Remarkable progress has been achieved through identification of the major quantitative trait locus (QTL) *SUB1* in the mid-1990s, which led to the identification of three ethylene responsive factors (ERFs), of which *SUB1A* is the primary contributor for tolerance. Several major QTLs have been mapped and several key genes underlying the QTLs have been cloned. These findings and the available molecular marker technology have enabled breeders to develop submergence-tolerant varieties through a fast-track marker-assisted backcrossing (MABC) strategy to introgress *SUB1* using mega varieties as recurrent parents. Recent advances in Genetics, genomics, and other modern technologies will also be continuously explored to open new avenues for understanding how rice plants cope with different types of flooding stress to meet future challenges facing rice production, most of which have intensified with global climate changes.

Keywords: flooding, submergence, QTL, *SUB1*, varieties

Influence of abiotic factors on growth and development of vegetable crops

Rahul Kumar Gupta and Ajay Bhardwaj

Department of Horticulture (Vegetable and Floriculture), Bihar Agricultural University, Sabour, Bhagalpur, Bihar-813210

ABSTRACT

Vegetables are one of the good sources of vitamins and minerals. They play an important role in ensuring food and nutritional security (Rai and Yadav 2005). Environmental-plant interaction is fundamental to growth and development of vegetable crops. Vegetables being highly perishable are very sensitive to genetic and environmental factors. Climatic and edaphic factors influence the production and productivity of vegetable crops and have greater impact on vegetative and reproductive phase of vegetables (Kumar et al. 2012). Temperature does not supply energy but control the rate of chemical reactions. Temperature influences the physiology of crops through thermoperiodism, soil temperature, vernalization and heat stress (Onwuka 2016). Light also influences the growth and development through photosynthesis and photomorphogenesis. Light quantity, quality and duration have promotive effect on vegetative part, colour of fruit and flower of vegetable crops. Exposure of high light intensity on the vegetables (fruit and leafy vegetables), deteriorates the quality of the produce (Pandey and Sinha 2016). Water is primary component in photosynthesis and respiration responsible for turgor pressure in cells. Water stress at the critical stage of growth and development leads to low mass production leads to poor yield (Kumar et al. 2012). Rahman et al. (2007) indicated that cauliflower growth parameters increased in size and weight with increase in mean growing temperatures after curd initiation up to an optimum temperature and then declined thereafter and significantly affected the growth of cauliflower. In another study Naz et al. (2018) observed reduction in fresh and dry weights of potato plants and significant increased accumulation of proline increase in heat stress conditions. In one or another way abiotic factors influence the growth and development of vegetable crops. In order to overcome environmental stress thorough screening of more abiotic stress tolerant genotypes of vegetables is required and transfer of tolerant genes by conventional and molecular methods need to be enhanced.

Keywords: Abiotic, Development, Perishable, Edaphic factor, Photomorphogenesis, Stress

Identification and Documentation of Indigenous Technical Knowledge practiced in agriculture and horticulture in Nalgonda District, Telangana

Pallavi, S.*¹, M.A. Aariff Khan¹, M. Shankar¹, T. Bharath¹, T. Himabindu¹ and M. Shankaraiah¹

¹Krishni Vigyan Kendra, Kampasagar, PJTSAU, Nalgonda Telangana -508207, India

ABSTRACT

The present study was attempted to document the Indigenous Technological Knowledge (ITK) and their application in agriculture and horticulture practices. The Indigenous Technical Knowledge (ITK) was based on the experiences of the local people being passed from one generation to next has been used for crop management practices since ancient times. The study reveals to identify and document different ITKs practiced in agriculture and horticulture by

3rd International Conference on “Global Initiative in Agricultural, Forestry and Applied Sciences for Food Security, Environmental Safety and Sustainable Development (GIAFAS-2021)”

the farmers of Nalgonda District, Telangana State. The information was collected from selected informants of the given area and documented in a systematic manner. Off late the climate change and modern developments has shown major impact on different aspects of agriculture, the ecology and biology of different insect pests has been changing and ultimately making the pest control mechanism difficult. Indiscriminate use of chemical pesticides in field crops not only developing resistance among the pests but also leading to environmental degradation. But, there are some tribal village farmers are still following some indigenous practices for pest management in their agricultural fields by using locally available materials and other resources with low cost. Blending ITKs with scientific knowledge is must for sustainable development of agriculture and horticulture. Some of the popular ITKs still in practice by farmers in tribal and remote villages of district, such as application of Aquatic weed extract as a pest control, Leaf extract solution for pest control, pulse jaggery mixed paste for pest control and Fish waste for improving growth and yield of crops.

Keywords: Documentation, Indigenous Technological Knowledge, Pest control, Crop anagement.

Plant diseases identification through computer technologies in tomato crop

Angelina Gill¹ and Yendrembam K Devi²

¹ *School of Computer Application, Lovely Professional University, Phagwara-144401*

² *Department of Entomology, School of Agriculture, Lovely Professional University, Phagwara-144401*

ABSTRACT

In agricultural production, insect-borne plant diseases are a major concern. Faster and more accurate disease identification and prediction in crops would help in the development of an early treatment strategy while reducing economic losses. With a high economic value and large production capacity, the tomato crop is an important horticultural crop globally including India. Diseases cause problems on a plant's health, reducing its ability to flourish and reduce the production capability of the crop. To ensure low economic losses due to plant diseases, it's critical to have a regular surveying and monitoring the farm for the disease symptoms appearance. A plethora of tomato diseases are causing havoc on the different parts of the tomato crop such as leaves, fruits etc. Accurate and precise disease diagnosis has proven to be difficult for effective input of integrated disease management in a large field. Recent technological advancements and significant cost reductions in the field of digital picture capture have made it possible to put a range of image-based techniques into practice. Support Vector Machines were utilised to extract key characteristics from a picture of a tomato leaf using the Gabor wavelet transform approach to detect and identify the type of disease that attacks tomato plants.

Keywords: Diseases, Tomato, Integrated Disease Management, Support Vector Machines

Induced Systemic Resistance in Chilli against *Colletotrichum capsici*: A Review

Adesh Kumar*, Adarsh Sharma, Tammana Rana and Shuja Ahmaed

Department of Plant Pathology, School of Agriculture, Lovely Professional University, Phagwara-144 411, India

ABSTRACT

Chilli, an important ingredient in Indian cuisine, is a major commercial commodity farmed in tropical and subtropical locations, with India being the world's leader in chilli production. Chilli is affected by several diseases viz., powdery mildew, fungal, bacterial wilt, leaf curl, etc. out of which the anthracnose of chilli is the most devastating disease, it is also termed as dieback or fruit rot caused by *Colletotrichum capsici*. The disease causes substantial damage in the field, as well as during storage and transit, exacerbating yield and overall crop production losses. Anthracnose disease has been observed to cause a 10–54 percent yield reduction in India. Because this disease is so common, scientists are using integrated management approaches such as physical, mechanical, biological, and chemical. However, management exercises performed after the disease has occurred have not proven to be effective or cost-effective. As a result, an approach that strengthens the plant from a very early stage is required and reliable, so induced resistance is proposed and discussed. Systemic acquired resistance (SAR) and induced systemic resistance (ISR) are two forms of induced resistance wherein plant defenses are preconditioned by prior infection or treatment that results in resistance against subsequent challenges by a pathogen or parasite. This paper focuses on having discussion about the concept becoming increasingly important which enables and empowers the plant system to tackle the target pathogen(s) using its own defense mechanism.

Keywords: *Capsicum* spp.; Chilli anthracnose; *Colletotrichum capsici*; Chemical management; Induced resistance; SAR; ISR.

3rd International Conference on “Global Initiative in Agricultural, Forestry and Applied Sciences for Food Security, Environmental Safety and Sustainable Development (GIAFAS-2021)”

Production of Fruit Powders and Formulation of Instant Probiotic Fruit Powder Mix

S Mounika, M Sairanavi, Dr. R. Swamy and Dr. J. Sai Prasad*

College of Food Science & Technology, Rudrur

Professor Jayashankar Telangana State Agricultural University (PJTSAU)

ABSTRACT

India's diverse climate ensures availability of all varieties of fresh fruits & vegetables. Preservation through drying is the most significant process of food storage for years together. Two drying methods (solar and oven) were used to dry the Apple, Mango, Orange, Sapota and Grapes. Grapes took high time 10 days (240 hrs) and remaining four fruits such as Apple, Mango, Orange, Sapota dried within 5 days in solar drying method. The similar results observed in hot air oven method Grapes were dried in 6 days (144 hrs). Proximate analysis Sapota fruit powder having highest content of protein (0.92%), fat (1.1%), carbohydrates (25%) and calcium (15.3mg/L) but both the method fruit powders having almost same nutrient composition however the drying time varied method to method. Concerning the microbiological parameters, we obtained results meeting the limits set by the ISO standard which governs the microbiology of the food chain.

Based on sensory evaluation fruit powders 10 formulations were made from the both drying methods. Overall in 10 formulations F5 of Hot air oven formulations having high overall acceptability. F5 of hot air oven method was taken for further preparation of instant probiotic fruit powder mix. Isolated and purified the *Lactobacillus casei* shirota from Yakult Probiotic milk. The 10⁷ cell count of this bacteria was added into final formulated best fruit powder mix. Finally it was proven that Probiotic bacteria does not influence the probiotic fruit drink mix in sensory evaluation of final product. The method of Hot air oven drying in view of the results obtained proves to be the one that boosts the good properties of all fruit powders in final best formulation.

Keywords: Oven; Solar dryer; Apple, Mango, Orange, Sapota and Grapes; Sensory evaluation; Proximate & Microbial analysis; *Lactobacillus casei shirota*.

Farmer Producer Organization- A Way Towards Success

Swarnima Paliwal*, R.S. Jadoun and Arunima Paliwal¹

G.B. Pant University of Agriculture & Technology, Pantnagar, U.S. Nagar, Uttarakhand, India

¹*College of Forestry, VCSG Uttarakhand University of Horticulture and Forestry, Ranichauri, Tehri Garhwal, Uttarakhand, India*

ABSTRACT

Farmers, especially small and marginal holders, constitute a major proportion of Indian agriculture. However, under formal contacts the weak bargaining power of small farmers suffer from huge dependency in the cultivation and monopolistic exploitation. Thus, to minimize the gap between farmers and producer's co-operative or Producer Companies based models are promoted. One such model is Farmer Producer Organisations (henceforth, FPOs) which can integrate the small farmers with agricultural market for remunerative prices with low transaction costs. FPO is a legal entity formed by group of farmers or primary producers, viz: agriculture farmers, milk producers, fisherman, small tea growers, weavers, craftsman etc. A FPO can be any entity (like a producer company, a cooperative society or any other legal form) providing the sharing of benefits/ profits among the members. For FPOs, registration is done under Companies Act, 1956. To make the better income for producers with the help of their own organisation is the primary objective of FPO. It helps farmers/ producers to get a better price for their goods. It also helps to create a better bargaining power for primary producers. It makes it possible for farmers to arrange themselves for action or to share resources. Farmers problems are inspected with extension support. Policies and demands for the required services are influenced by FPO. The Government of India according to year 2018 reported that NABARD has recognized relatively higher number of promoting institutions about 818. NABARD has recognized highest number of promoting institutions in the state of Karnataka (78) and is followed by Uttar Pradesh (77), Kerala (73), Rajasthan (57), Andhra Pradesh (57), Bihar (52) etc. Similarly, SFAC has recognized highest number of promoting institutions in the state of Madhya Pradesh (21) and is followed by Assam (12), Uttar Pradesh (06) etc. A flexible approach is required to adopt to serve to the needs of producers so that account hiking of FPOs is formidable. A prerequisite for making an FPO successful is to have establishment of central agency to disseminate awareness about the practices of PCs among all the stakeholders.

3rd International Conference on “Global Initiative in Agricultural, Forestry and Applied Sciences for Food Security, Environmental Safety and Sustainable Development (GIAFAS-2021)”

Effect of Plant Spacing and Training on Fruit Quality of Capsicum (*Capsicum annuum* L) under Protected conditions.

Ghanshyam Thakur*¹, Anil Kumar Singh², Pankaj Kumar Maurya³

1. Department of Horticulture, Dr. Rajendra Prasad Central Agricultural University Pusa, Samastipur (Bihar), India

2. Assistant Professor cum Junior Scientist, Department of Horticulture, Dr. Rajendra Prasad Central Agricultural University Pusa, Samastipur (Bihar), India

3. Department of Horticulture, Dr. Rajendra Prasad Central Agricultural University Pusa, Samastipur (Bihar), India

ABSTRACT

Sweet pepper belongs to the family Solanaceae. The crop has immense commercial dietary and therapeutic values. That is the world's 2nd most significant vegetable, after the tomato. Plant spacing and sowing date are significant characteristics of several agricultural production systems. During September 2016 to 2017, the experiment was conducted at Hi-Tech Horticulture, Dr. RPCAU Pusa, Samastipur, Bihar, with the effect of plant spacing and training on fruit quality of capsicum (*Capsicum annuum* L) under protected conditions. The research design was used to analysis the data factorial RBD with thrice replication with three levels of spacing and training. Under S₃P₁ (45 cm × 60 cm + two shoots), the maximum length of fruit, breadth of fruit, volume of fruit, fruit shelf life, rind thickness, A⁺ and 'A' grade fruits were found among the various combinations of spacing and training level. At all crop growth stages, maximum 'B' grade fruits were recorded in S₁P₁ (45 cm × 30 cm + two shoots), whereas highest 'C' grade fruits were reported in S₁P₃ (45 cm × 30 cm + four shoots). Hence, I have suggested for future, the intermediate spacing, with four shoots of training levels should be follow for maximum yield with better quality of capsicum fruit as well as economic benefit for growers.

Keywords: Sweet pepper, training, Plant spacing, protected conditions.

Monitoring the effect of Deuteromycetes Fungi on host plants

Aditi Maithani, Laxmi Rawat

Plant Pathology, College of Forestry, Ranichauri, Tehri Garhwal – 249199

V.C.S.G. Uttarakhand University of Horticulture and Forestry, Uttarakhand

ABSTRACT

Fungi, a group of varying organisms, which are eukaryotic carbon heterotrophs which may be saprobic or parasitic in nature and for the easy identification, fungi are classified as two divisions i.e., Myxomycota and Eumycota. Eumycota which is also known as true fungi is further classified on the basis of production of sexual spores into other five sub-division that are: Mastigomycotina, Zygomycotina, Ascomycotina, Basidiomycotina and Deuteromycotina. Deuteromycetes, also known as molds, are grouped as second-class fungi because of the absence of sexual state i.e., anamorphic state. This imperfect group of fungi is further divided into three informal classes on the basis of presence of conidia and kind of conidiomata as hyphomycetes, coelomycetes and blastomycetes. Many of these economic fungi are of great economic importance, some of which cause many serious diseases of plants such as wilt, botrytis blight, tea grey blight, turmeric leaf spot etc. These classes of imperfect fungi are responsible for many rots, wilts, molds, leaf spot and other symptoms on the host plants which they infect. The symptoms produced by these fungi are mostly well defined and recognizable. This group of fungi produces asexual spores on distinct conidiomata such as pycnidia or acervuli. The infection caused by these groups can be controlled by using integrated approach comprising of cultural methods, mechanical methods, chemical methods, biological methods as the sustainable mode of managing the disease by causing minimum harm to the ecological surroundings. This review discusses in detail about the effects of deuteromycetes on host plants by reviewing some case studies as well.

Key words: Deuteromycetes, Eukaryotic, Fungi and Imperfect fungi.

3rd International Conference on “Global Initiative in Agricultural, Forestry and Applied Sciences for Food Security, Environmental Safety and Sustainable Development (GIAFAS-2021)”

Current scenario of Step Farming in Hilly Areas of Uttarakhand

Gosiya Ayub, Moinuddin and Ankit Semwal

College of Agricultural Sciences, Shri Guru Ram Rai University Dehradun, Uttarakhand, India-248001

ABSTRACT

In Step farming the terraces are a thing of beauty, this forms involve creating steps on slopes of the mountains for agricultural activity to prevent soil erosion during the rainy and also makes for a pretty good landscape for pictures. Step farming is done because there are mountains unlike plains. In plains areas are generally bigger as compare to mountains fields and can use big tractors and other implementations for agricultural work whereas in mountains we have to make steps like farms according to slops and can only use Ox-plough or Indigenous plough for ploughing purposes. Step farming majorly done in mountains areas because there are mountains unlike plains. It is a method where arable land can be cultivated even on the steepest of slopes, it is done by cutting the steps on the slopes of the hill. There are some crops which are generally can be grown in step farming like- tea, coffee, horse gram, rice, wheat etc. fir irrigation method only surface irrigation method is used because of lack of facilities and the ideal locations. Mainly upper fields are irrigated then after fields downward areas are irrigated, firstly upper fields, when upper fields are irrigated successfully then by runoff lower fields are irrigated. Labour work is high in step farming because the lack of carrier technology, labour have to carry the yield to the transport or the location by themselves, no machinery can reach easily to the field because of lack of road facilities. Majorly step farming is done by traditional methods. Like indigenous ploughing, surface irrigation system, harvesting and threshing by traditional methods and others also.

Keyword: Terrace Farming, Mountains, Ploughing, Indigenous

Effects of bioaccumulation of copper on growth and biochemical constituents of the seedlings of *Casuarina equisetifolia* L.(CASUARINACEAE)

Rathna Kumari, B.M¹ and Raveesha, H.R²;

¹Department of Botany, Government First Grade College, Vijayanagara, Bengaluru-560 104, India,

²Department of Botany, Bangalore University, Jnana Bharathi Campus, Bengaluru-560 056, India

ABSTRACT

Accumulation of heavy metals in soil causes significant impact on the biological processes in the plants. In the present study, the impact of bioaccumulation of copper (Cu) on growth and biochemical constituents of the seedlings of *Casuarina equisetifolia* was assessed. The results showed that, *C. equisetifolia* is a hyper-accumulator of Cu. The roots of the *C. equisetifolia* significantly accumulated ($p < 0.05$) greater levels of Cu than stem and leaves. Similarly, the seedlings exposed to different concentrations of Cu showed differential height and collar diameter. The higher concentrations of Cu significantly ($p < 0.05$) hindered the fresh and dry weights of seedlings. It was noticed that accumulated Cu caused significant decrease in levels of total carbohydrates, proteins and chlorophyll contents in *C. equisetifolia* seedlings.

Keywords: *Casuarina*, copper, accumulation, biochemical constituents, biological processes

Mechanization in rice cultivation and advanced technology implemented

V. KALIRAJAN

Department of Agricultural Extension, Faculty of Agriculture, Annamalai University, Tamil Nadu.

ABSTRACT

Mechanization in rice cultivation is the key role in increase of productivity, profitability and cropping intensity. Without a review of patterns and progress in farm power availability farmers would struggle to emerge from subsistence production. Present scenario of rice mechanization including availability of farm machinery/implements for different field operations starting from field preparation, sowing/transplanting, intercultural operations, harvesting, threshing and post harvesting operations is compiled. Future research areas are identified to enhance the mechanization level by performing field operations timely, precisely, and efficiently. Precise and need based application of inputs results in reducing cost of rice cultivation with optimal use of energy and drudgery reduction in farm operations. Farm machinery and equipment provide a package of technology to increase land productivity by improved timeliness of operations, reduced crop losses and improved quality of agro-produce.

Keywords: Mechanization, subsidence farming, machinery, application of input, drudgery reduction.

3rd International Conference on “Global Initiative in Agricultural, Forestry and Applied Sciences for Food Security, Environmental Safety and Sustainable Development (GIAFAS-2021)”

Morphological characters of French marigold (*Tagetes patula* L.) genotypes

Priya Bhusaraddi, V.V. Bhagat and B. S. Kulkarni

Department of Horticulture, Vasantrya Naik Marathwada Krishi Vidyapeeth, Parbhani., (M.S.). India

ABSTRACT

The present investigation was undertaken to examine the morphological characters of different French marigold genotypes and to know extent of genetic variability present in the population. Correlation and path coefficient analysis between yield and its contributing traits and divergence studies were also done. The experiment laid in Randomised Complete Block Design with 25 genotypes replicated twice.

The genotype Pusa Arpita showed maximum plant height (50.54 cm), stem girth (13.35mm), number of primary branches (22.4), leaf length (18.87 cm), leaf width (14.10 cm) and shelf life (4.95 days), IIHRFm-411 genotype exhibited higher plant spread (55.57 cm in E-W and 52.27 cm in N-S), number of secondary branches (44.5), flower yield per plant (392.10 g) and flower yield per ha(16.01 ton). Pusa Deep recorded highest number of flowers per plant (170.7), individual flower weight (4.27 g) and flower diameter (45.03 mm) were found maximum in IC-250322-01. UHSFm-10 took minimum days to first flower appearance (26.5 days), UHSFm-8 recorded minimum days to 50% flowering (32.5 days) and flowering duration maximum in IC-250322 (49 days).

In genetic variability study higher (> 20%) GCV and PCV were reported for traits plant height, plant spread from east to west and north to south, leaf length, width, stem girth, flower yield per plant and per hectare, individual flower weight and shelf life. The higher broad sense heritability (>60%) coupled with higher (20% and above) genetic advance as percent mean (GAM) was recorded for almost all the parameters except flowering duration.

The significant positive correlation was reported with plant height, plant spread from east to west and north to south, primary and secondary branches, leaf length, leaf width, stem girth, individual flower weight, shelf life, days to first flowering, 50% flowering and flower yield per plant and hector. In path analysis direct positive association for flower yield per plant was seen with traits plant spread north to south, number of primary and secondary branches per plant, leaf width, individual flower weight, flower diameter, shelf life, number of flowers per plant, days to 50% flowering, duration of flowering and flower yield per hector.

Keywords: French marigold, Genetic variability, Heritability, Correlation, Path-coefficient

Effect of spacing and leaf cuttings on leaf and seed yield of spinach (*Beta vulgaris* L.) var.

All green

V. V. Bhagat, Saba sheikh Najeer and A. S. Lohakare

Department of Horticulture, Vasantrya Naik Marathwada Krishi Vidyapeeth, Parbhani., (M.S.). India

ABSTRACT

The experiment was laid out in Factorial randomized (FRBD) with three spacing (15, 30 and 45 cm row to row) and four cuttings (no cutting, one cutting, two cuttings and their cuttings). Maximum mean height of palak was recorded in 15 cm spacing (51.80 cm), in no cutting (77.20 cm). Maximum number of leaves was recorded in 45 cm spacing (17.75) and in no cutting (18.33). As regards length of petiole maximum length of petiole was observed in 45 cm spacing (12.45 cm) whereas maximum petiole length was recorded by no cutting (15.06). Maximum stem girth was found in 45 cm spacing (1.502) and in one cutting (1.526) Interaction combination of one cutting with 45 cm spacing recorded maximum stem girth. Maximum leaf area per plant was recorded in 45 cm spacing (647.76) and in no cutting (907.31). Green yield per plant was maximum in 45 cm spacing (39.11 g) and in three cutting (67.94 g). Yield per plot and per hectare were medium in 15 cm spacing (7.32 kg and 108.10 q/ha respectively). Green yield per plant 67.94 g, per plot and per hectare was observed in three cuttings i.e. 9.98 kg and 147.36 q/ha respectively. Interaction combination i.e. three cuttings with 15 cm spacing produced maximum green yield per plot (13.40 kg) and per hectare (197.93 q). Maximum seed yield per plant was obtained in 45 cm spacing. As regards cutting maximum seed yield per plant was recorded in one cutting treatment (6.38 g). Similarly, maximum seed yield per plant was recorded in treatment combination i.e. one cutting with 45 cm spacing (6.52 g). Per plot and per hectare seed yield was maximum in 15 cm spacing i.e. 1.29 kg and 19.07 q. Post-harvest observations weight of 1000 seeds Maximum weight of 1000 seed was in 45 cm spacing (14.62 g) and in no cutting (14.91 g). More germination percentage was observed in 45 cm spacing 74.03 %. As regards cuttings one cutting recorded maximum germination percentage of 75.79%.

Keywords: Spacing, Cutting, Interaction, Seed yield, Green yield, Palak (*Beta vulgaris* L.).

3rd International Conference on “Global Initiative in Agricultural, Forestry and Applied Sciences for Food Security, Environmental Safety and Sustainable Development (GIAFAS-2021)”

A Review on Significance of Pollination Services

Ranjeet Kumar, Himani Saini and Sangeeta Verma

Himalayan Forest Research Institute, Panthaghati, Shimla, H.P., India-171013

ABSTRACT

The life of the human beings is improved and sustained by ecosystem services provided by the nature. The provisioning, regulating, cultural and supporting services are four categories of ecosystem services. Pollination services is one of important ecosystem services and can fit in all the categories of services. Food, cloth and house for shelter are important essential elements for survival and pollination has direct and indirect role with these three things. However, food is one of the most important provisioning services. Pollination has direct linkage with productivity. Pollination is also important regulating services by helping in plant reproduction and maintaining the health of ecosystem and diversity of the plants. Plants help in purifying water and air and also can be indirectly linked with soil erosion. Pollinators are also linked with cultural symbolism.

The review of literature also revealed that the global economic value of crop pollination services ranged from US\$195 to US\$387 billion adjusted according to inflation of March 2020. A study in India found that 40% of 139 NWFP species which are important for livelihood of people is directly benefitted from biotic pollination. The pollinations increase the productivity of the area where agriculture and forest landscapes are adjoined with each other so pollination services provide cultural, financial, ecological, health and social values.

Key words: Ecosystem services, pollination, forests, agriculture and productivity.

Current Scenario and its Future Prospectus of Aquaponics

Moinuddin, Aishwarya Petwal and Ankit Semwal

School of Agricultural Sciences, Shri Guru Ram Rai University Dehradun, Uttarakhand, India-248001

ABSTRACT

In the area where land, water, soil is less, one of the emerging techniques, Aquaponics, is the better way for making life sustainable on earth. According to a joint report from the Food and Agriculture Organization and Smart Fish, aquaponics is the cultivation of plants and aquatic animals in a recirculating environment. Aquaponics is a cooperation between plants and fish and the term originates from the two words aquaculture and hydroponics. This is an environmentally friendly, natural food-growing method that harnesses the best attributes of aquaculture and hydroponics without the need to discard any water or filtrate or add chemical fertilizers growing of plants usually in a soil-less environment. Aquaponics relies on the food introduced for fish, which works as the system's input. As fish eat this food and process it, they transform it into urine and fecal matter, both rich in ammonia, which in sufficient quantities can be toxic to plants and fish. Afterward, the water (now ammonia-rich) flows, together with un-eaten food and decaying plant matter, from the fish tank into a biofilter. Afterward, inside this biofilter, bacteria break everything down into organic nutrient solutions (nitrogen-rich) for growing vegetables. It is a growing sector with immense advantages. There are some current scenario of aquaponics like Demand for fishes and crops (lettuce, spinach, capsicum, coriander, broccoli and some other leafy plants) is increasing rapidly in urban areas. This technique helps the farmer in increasing the productivity of his land. Augment farmer's income especially in non-coastal areas. There are some future aspects of this like- The future work will focus on the production of pollutants in the aquaculture section, the conversion and degradation of the pollutants in the microbial treatment section, uptake and adsorption of organic nutrients and inorganic salts in the hydroponics section, The global Aquaponics market was valued at USD 24 in 2020 and will reach USD 46 million by the end of 2027, growing at a CAGR of 11.5% during 2022-2027. In 2021, the market is growing at a steady rate and with the rising adoption of strategies by key players, the market is expected to rise over the projected horizon, As aquaponics systems work anywhere in the world, they can be used as pilots in developing countries to meet the food security needs of people.

Key words- Aquaponics, Food, Agriculture, Hydroponics and Environment

3rd International Conference on “Global Initiative in Agricultural, Forestry and Applied Sciences for Food Security, Environmental Safety and Sustainable Development (GIAFAS-2021)”

Nutritional Benefits of Hibiscus Plant

Deepak Som, Moinuddin, Deepti Yadav, Ankit Semwal and Aditya Mittal

School of Agricultural Sciences, Shri Guru Ram Rai University Dehradun, (U.K.) India

ABSTRACT

Hibiscus is a large genus of flowering plants with hundreds of species belonging to biological family Malvaceae (mellow). Among these, Hibiscus *Rosa-Sinensis* is the most widely cultivated flowering shrub in gardens. It is known by many common names like ‘China rose’, ‘Jaswand’, ‘Gurhal’ etc. It is a handsome bushy shrub that can grow up to 1-2m tall. The plant can flower throughout the year in moderate and humid climatic conditions. The plant is excellent for shrubbery, hedge & as a single specimen on the lawn. It has also great medicinal benefits, consumed as tea, having health benefits. In India it’s also used in hair loss treatment. The easiest way of propagating hibiscus is by hardwood cuttings. Here you will get a simple step by step guide to propagating hibiscus and you would need a mother hibiscus plant, secateurs or a study scissor, and a container to place the cuttings. It is a simple and time saving process. Hibiscus tea also called sour tea because of its tart taste, is made from a mixture of a dried hibiscus flowers, leaves and dark red calyces (the cup shaped center of the flowers). After the flower finishes the blooming, the petals fall off and the calyces turn into pod. These hold the plant seeds. Calyces are often the main ingredients in herbal drink containing hibiscus. Hibiscus is being used by different cultures methods as a remedy for several conditions. Egyptians used hibiscus tea to lower body temperature, treat heart and nerve diseases and as a diuretic to increase urine production. In Africa tea was used to treat constipation, cancer, liver disease and cold symptoms. Pulp made from the leaves was applied to the skin to heal wounds. It is packed with antioxidant molecules that help fight compounds called free radicals, which cause damage to our cells, also helps to lower blood fat levels and may boost liver health also could promote weight loss and compound that may help prevent cancer. It could help to fight with bacteria. With all these benefits nature makes hibiscus plant a boon for human health.

Key words- Hibiscus, Gurhal, Hardwood, Calyces, Nutrition, Tea.

Impact of Global Warming on Crop Production

Wasim Khan, Moinuddin*, M. Sekhar, B. Rahul***, and Siddhant Gupta****

Department of Agronomy, SHUATS, Prayagraj (U.P)

**Shri Guru Ram Rai University- Dehradun (U.K) India*

Department of Biotechnology BHU, Banaras, (U.P) India

ABSTRACT

The data collected by different research scientists and organizations at different locations in the world that is compiled together and used to see the effect of global warming on crop production. The simulation results indicate that increasing temperature poses a serious threat in decreasing growth and yield of crops. However, increased CO₂ levels may be helpful in counteracting the adverse effect by favouring crop yields. At reproductive stage of crop, the increased maximum temperature by 1⁰C decrease the yield 3-4 q/ha and 2⁰C rise in temperature decreased yield by 5-6 q/ha. Increasing temperature decreases the reproductive stage of rice by 7 days, hence the potential rice yield decrease by about 5 q/ha. Instead of transplanting and submerged paddy cultivation, water saving technology controls the CH₄ emission. Drought resistance varieties, adaptation of crop rotation, minimum / zero tillage, windbreak, sustainable land management along with appropriate machinery and equipment are important issues to reduce the adverse effect of heat/ high temperature stress.

Key words: Global Warming, Crop Production

Indigenous Technical Knowledge (ITK) for Sustainable Development in Agriculture

M. Sekhar, M. Madhu* Moinuddin and B. Rahul*****

Department of Agronomy, SHUATS, Prayagraj, India

**Sphoorthy Engineering College, Hyderabad, India*

***Shri Guru Ram Rai University- Dehradun (U.K) India*

****Department of Biotechnology, BHU, Banaras, India*

ABSTRACT

Indigenous technical knowledge (ITK) is commonly, local and rural in origin. The source of ITK is our ancestors, who learned techniques from their past experiences and experiments and these vary from place to place. Indigenous Technical knowledge (ITK) is the local knowledge –knowledge that is unique to a given culture or society. It is the knowledge, which has been accumulated by the people over generations by observation, by

3rd International Conference on “Global Initiative in Agricultural, Forestry and Applied Sciences for Food Security, Environmental Safety and Sustainable Development (GIAFAS-2021)”

experimentation and by handling on old peoples' experiences and wisdom in any particular area of human behaviour. It is the basis for local-level decision making in agriculture, health care, food preparation, education, natural-resource management, and a host of other activities in rural communities. This knowledge plays imperative role in many grassroots innovations. ITK covers a wide range of subjects such as crop production, livestock rearing and natural resource management. Despite the wide recognition of indigenous peoples' contribution to the world's cultural and biological diversity and sustainable development, many challenges still remain in the area of traditional knowledge and technologies. Agriculture plays the most vital role in Indian economy. An appropriate coalition between the traditional and modern knowledge and technology systems has immense potential to benefit the society

Keywords: *ITK, Indigenous knowledge*

Selection of phenotypically superior trees of Jujube (*Ziziphus jujuba* Mill.) as an agroforestry tree species under stress conditions

M. Maqbool Rather, Firdous A. Sheikh, P. A. Khan and *Manzoor A. Dar

Faculty of Forestry, SKUAST-Kashmir, (J&K) India

**Doon (P.G) College of Agriculture Science and Technology- Dehradun*

ABSTRACT

Jujube (*Ziziphus jujuba* Mill.) is one of the most important genera of Rhamnaceae or bulkthorn family. It comprises about 170 species, distributed mostly in the tropical and sub-tropical regions of the Old and New World, with a few species occurring in the temperate regions (Liu and Cheng, 1995) but only 40 species of this genus have been reported throughout the world (Soliman and Hegazi, 2013; Li *et al.*, 2007). Its common name is Chinese date or Chinese jujube. It is native to China and distributed in over 47 countries around the world (Li *et al.*, 2005; Liu *et al.*, 2014). The taxon has been found commonly growing on the terraced tablelands, locally called as 'Karewas', and along the foot hills in the Kashmir Valley (Akhter *et al.*, 2013). The tree is very graceful and ornamental in appearance. The fruit is rich in nutrients, and famous for the sweet, apple-like taste with potassium, phosphorus, calcium and manganese being the major mineral components, as well as iron, sodium, zinc and copper (Li *et al.*, 2005). The jujube is a rich source of vitamin C and vitamin B-complex. Jujube is highly tolerant to drought and well adapted to diverse climatic conditions and not only survives but produces reasonable yield and growth under severe drought helped by its deep and substantial taproot. The study has been undertaken to select tree species from different sources as an agroforestry tree component under stress conditions. Tree characters viz. tree height, DBH, clear bole, crown spread and fruit bearing have been utilised as a base for selection of phenotypically superior trees. Initial study suggests that the seeds from different sources differentiated in producing seedlings with varied growth characteristics.

Influence of Chemical Fertilizers on Growth, Yield and Nutrient Content of Mungbean (*Vigna radiata* L.)

Siddhant Gupta*, Moinuddin, M. Sekhar** and Meenakshi Joshi*****

** & ***Department of Agronomy, SHUATS, Prayagraj (U.P) India*

***Shri Guru Ram Rai University- Dehradun (U.K) India*

****SDBIT, Dehradun (U.K) India*

ABSTRACT

An experiment was conducted with mungbean genotype IPSA-13 in the field of CRF, Department of Agronomy, SHUATS during September, 2019 to November, 2019 to study the root growth, nutrient concentration and seed yield of mungbean as influenced by N and K under waterlogged conditions. Nutrient supply in the soil had significant impact on better recovery in root development of 4-day waterlogged plants. Development of adventitious roots was one of the adaptive responses of IPSA-13 mungbean genotype. Root length was decreased due to the anaerobic condition. Plants waterlogged for 4-days allocated more dry matter in adventitious root development and hence root volume was higher in waterlogged plants. Root volume in flooded plants increased due to the development of adventitious roots. Root dry weight increased with combined application of N and K fertilizers. Flooded plants treated with 14 kg N ha⁻¹ + 25 kg K ha⁻¹ produced the highest TDM and seed yield, though the yield was statistically similar to that obtained when the levels of N and K were applied separately, as well as with that of 1% urea + 25 kg K ha⁻¹.

Keywords: Nitrogen and potassium, root growth, nutrient content, soil moisture, mungbean

3rd International Conference on “Global Initiative in Agricultural, Forestry and Applied Sciences for Food Security, Environmental Safety and Sustainable Development (GIAFAS-2021)”

Basic Reasons for Poor Nutritional and Health Status of Children

Nandana Kumari* and Prof. Rita Singh Raghuvanshi**

Scientist (Home Science), KVK, Bokaro, Jharkhand and ex-Dean, College of Home Science, G.B.P.U.A.T., Pantnagar***

ABSTRACT

Jharkhand, a newly built state, is one of India's poorest states and malnutrition is a serious problem. From NFHS report, it was found that the nutritional and health status of children in Jharkhand is poor. Thus, the objective of the present study was to investigate the basic reasons responsible for poor nutritional and health status of children. The present study was conducted in Ranchi district by covering two basti of kanke block and 100 families of Misirgonda (treated as control group) whereas 100 families of Dhawannagar (treated as experimental group). A pre-structured survey schedule was developed to collect baseline information. From research, it was revealed that there were so many primary reasons responsible for children's poor nutritional and health status. First of all, regarding birth place, in control group 81 per cent children were born at home and only 19 per cent children were born in hospitals. The percentage of children whose time to start their weaning process at 4 months i.e. at the right time were in least quantity i.e. 3 per cent in control group and 10 per cent in experimental group. Approximate 33 per cent children in control group and 27 per cent in experimental group continue their breastfeeding up to 3 years. Food restriction even for small children had adopted in 30 per cent family in control group and in 23 per cent family in experimental group. Regarding morbidity pattern, it was clear that 4 per cent and 26 per cent children in control group and in experimental group respectively had faced regular attack of cold, cough, fever, jaundice and diarrhoea etc and approximate 50 per cent children in control group and 24 per cent in experimental group were hookworm infested due to which prevalence of anaemia is very high among small children. In such situation, there is need of an environment for sound health and nutritional status of children depends upon availability of good nutrition for pregnant and lactating mother, skilled health personnel, adequate health care facility, medicines and emergency care when needed. Then only pregnancy and child birth will be times of joy for parents and families.

Keywords: Malnutrition, children, nutritional status, anemia, morbidity pattern

Genetic variability parameters for traits related to shoot fly tolerance in colored pericarp sorghum (*Sorghum bicolor* (L.) Moench)

S.S. Deshmukh, R.R. Dhutmal and A.W. More

Department of Agricultural Botany, College of Agriculture, VNMKV, Parbhani 431402 (MS)

ABSTRACT

A field experiment comprised of 76 genotypes and 5 checks was carried out during *rabi* 2019-20 at Sorghum Research Station, VNMKV, Parbhani to access the genetic variability in colored pericarp sorghum germplasm lines for traits related to shootfly tolerance. The experiment was carried out in randomized block design with two replications. The observations were recorded on seedling vigor, seedling glossiness, dead heart @ 28 DAS, shoot fly eggs @ 21 DAS, trichome density, leaf angle, grain yield per plant and fodder yield per plant. Analysis of variance revealed highly significant differences among treatments in respect of all the traits studied. The genetic variability studies revealed that the genotypes used in the study had considerable variability which provides sufficient basis for the selection. The genotypes GP 374, GP 920, 104B, GP 1673, RIL 40369-1, ISSVT 325, and GP 75 showed superior performance for the traits conferring tolerance to shootfly tolerance *viz.*, seedling vigor, seedling glossiness, shoot fly dead heart @ 28 DAS, shoot fly eggs @ 21DAS and trichome density. High heritability together with high genetic advance as percent of mean noticed at for plant height, number of primaries per panicle, panicle type, panicle length, panicle width, grain color, glume color, grain yield, fodder yield, seedling vigor, seedling glossiness, dead heart percent, shoot fly eggs, trichome density supported the predominance of additive gene controlling these characters.

3rd International Conference on “Global Initiative in Agricultural, Forestry and Applied Sciences for Food Security, Environmental Safety and Sustainable Development (GIAFAS-2021)”

Genetic diversity for grain yield and it's attributing traits in coloured pericarp sorghum (*Sorghum bicolor* (L.) Moench)

S.S. Deshmukh, R.R. Dhutmal and A.W. More

Department of Agricultural Botany, College of Agriculture, VNMKV, Parbhani 431402 (MS)

ABSTRACT

Sorghum is one of the indispensable crops required for the survival of humankind. Sorghum (*Sorghum bicolor* (L.) Moench) is the 'king of millets' and one of the most efficient, environmentally friendly, widely used & adapted crop, commonly known as 'Grate Millet' due to larger size of grain among millets and vast area under cultivation. The experiment was carried out in randomized block design with two replications at Sorghum Research Station, VNMKV, Parbhani. The experimental material comprised of 76 genotypes and 5 checks to access the genetic diversity in colored pericarp sorghum germplasm lines evaluated to access association between grain yield and it's attributing traits. The observations were recorded for days to 50% flowering, plant height, number of primaries per panicle, panicle type, panicle length, panicle width, days to physiological maturity, grain color, glume color, 100-seed weight, threshability, grain yield per plant, fodder yield per plant. On the basis of D² and Tocher's dendrogram the results revealed sufficient genetic divergence among 81 genotypes. For 13 morphological traits 81 genotypes were grouped into 8 clusters. Cluster I was big comprising 30 strains followed by cluster II with 15 genotypes, cluster IV with 14 genotypes, cluster III had 12 strains, cluster V comprising 7 genotypes. As seen from the result that clusters VI, VII, VIII were solitary cluster while, for shoot fly traits genotypes were divided into 6 clusters. The cluster III had highest number of genotypes 36 followed by cluster II with 16, cluster IV with 10 and cluster I with 9 genotypes, cluster VI have 6 strains and cluster V have 4 genotypes. Highest contributing traits towards the genetic diversity were grain color, glume color, plant height, number of primaries per panicle and panicle type

Character association studies for grain yield and it's attributing traits in coloured pericarp sorghum (*Sorghum bicolor* (L.) Moench)

R.R. Dhutmal, S.S. Deshmukh and H.V. Kalpande

Department of Agricultural Botany, College of Agriculture, VNMKV, Parbhani 431402 (MS)

ABSTRACT

Seventy-six coloured pericarp germplasms and 5 checks were evaluated during *rabi* 2019-20 at Sorghum Research Station, VNMKV, Parbhani to access the correlation for grain yield and it's related traits in colored pericarp sorghum. The experiment was carried out in randomized block design with two replications. The observations were recorded for days to 50% flowering, plant height, number of primaries per panicle, panicle type, panicle length, panicle width, days to physiological maturity, grain color, glume color, 100-seed weight, threshability, grain yield per plant and fodder yield per plant. In the present analysis grain yield had significant positive association with days to 50% flowering, number of primaries per panicle, days to physiological maturity, panicle length, panicle width, threshability and fodder yield per plant. These traits could serve as imperative characters in any selection programme for high yielding colored pericarp sorghum. Traits like days to 50% flowering, panicle type, panicle length, panicle width, days to physiological maturity, grain color, fodder yield had positive direct effect and had positive correlation with grain yield indicating simple selection based on these traits would be rewarding. The residual factor was moderate (0.203 and 0.280) at both genotypic and phenotypic levels respectively pointed out that there may be environmental component which is contributing towards grain yield.

Genetic diversity for traits related to shootfly tolerance in coloured pericarp sorghum (*Sorghum bicolor* (L.) Moench)

R.R. Dhutmal, S.S. Deshmukh and A.W. More

Department of Agricultural Botany, College of Agriculture, VNMKV, Parbhani 431402 (MS)

ABSTRACT

Sorghum is one of the important cereal crop in the world occupying fifth position after Wheat, Maize, Rice, Barley. In India, Sorghum is cultivated over 4.10 million ha. The annual production of sorghum is 4.49 million tons of grain with a productivity of 1018 Kg/ha. In India sorghum is mainly grown in Maharashtra, Karnataka, Tamilnadu, Andhra Pradesh, Rajasthan and Madhya Pradesh. To address the colored Pericarp sorghum in holistic manner and to generate additional information on extent of diversity in colored pericarp sorghum the present investigation entitled in Colored Pericarp Sorghum (*Sorghum bicolor* (L.) Moench)' was undertaken during *Rabi* 2019-2020 in 81

3rd International Conference on “Global Initiative in Agricultural, Forestry and Applied Sciences for Food Security, Environmental Safety and Sustainable Development (GIAFAS-2021)”

germplasm lines for traits conferring shoot fly tolerance. The observations were recorded on seedling vigor, seedling glossiness, dead heart @ 28 DAS, shoot fly eggs @ 21 DAS, trichome density, leaf angle, grain yield per plant and fodder yield per plant. Based on genetic divergence through D² analysis, the maximum inter cluster D² value observed between cluster V and VII (D= 57.91) followed by cluster V and VIII (D=52.55) for shoot fly inter cluster D² value maximum for cluster V& II (D= 80.81) which is followed by cluster II & I (D= 66.29). These suggest that there was wide diversity present among these clusters. Maximum contributing traits were trichome density, shoot fly dead heart @28 DAS and seedling glossiness. These traits will offer a good scope for development of resistance against shoot fly.

Effect of Integrated Nutrient Management on Growth and Yield of Pomegranate (*Punica granatum*L.)

Bhagyaresha R. Gajbhiye*, V. D. Patil and Tejswini R. Kachave

Dept. of Soil Science and Agricultural Chemistry, Banana Research Station, Nanded

ABSTRACT

A field experiment was conducted on “Effect of Integrated Nutrient Management on Disease Resistance of Pomegranate (*Punicagranatum*L.) Orchards” during 2017-18 and 2018-19 at College of Agriculture, Golegaon, VNMKV, Parbhani. The experiment was laid out in randomized block design with seven treatments i. e. T₁- Absolute Control, T₂- Farmer’s Practices (½ RDF), T₃- RDF (625:250:250 g N, P₂O₅, K₂O tree⁻¹), T₄- INM (15 kg FYM + 8 ml *Azotobacter*, 8 ml PSB, 100 g *Trichoderma*+ RDF), T₅- RDF + Antibiotics (Streptocycline @ 250 ppm), T₆- T₄ + Antibiotics, T₇- T₄ + Umber (*Ficusracemosa*)Rhizosphere Hybridised Soil (URHS @ 25 kg per tree) and four replications. The growth parameter, height of pomegranate plant at flowering and harvesting showed statistical significance with application of FYM @ 15 kg, *Azotobacter* @ 8 ml per tree, PSB @ 8 ml per tree and *Trichoderma* @ 100 g per tree, 625:250:250 g N, P₂O₅ and K₂O per tree and 25 kg URHS per tree (T₇) except treatment INM (FYM @ 15 kg + *Azotobacter* @ 8 ml per tree, PSB @ 8 ml per tree and *Trichoderma* @ 100 g per tree + 625:250:250 g N, P₂O₅ and K₂O per tree)+ Antibiotics (Streptocycline @ 250 ppm per tree)(T₆). It was ranged between 159.88 to 171.88 cm. The spread of pomegranate tree was not found significant with Integrated Nutrient Management practices (FYM, Solubilizers, RDF, Antibiotics and URHS).

Yield attributes viz., number of flowers (204.75), number of fruits (172.88), fruit set (84.39 %), fruit weight (244.82 g) and yield (41.21 kg tree⁻¹) of pomegranate were significantly increased due to application of treatment T₇ and found to be at par with treatment T₆.

Keywords: INM, plant height, fruit set, yield, pomegranate

Effect of Integrated Nutrient Management (INM) on Available Micro Nutrients of Pomegranate (*Punica granatum*L.) Orchard Soil

Bhagyaresha R. Gajbhiye*, V. D. Patil and Tejswini R. Kachave

Dept. of Soil Science and Agricultural Chemistry, Banana Research Station, Nanded

Vasantrao Naik Marathawada Krishi Vidyapeeth, Parbhani 431402 (M.S.) India

ABSTRACT

A field experiment was conducted on “Effect of Integrated Nutrient Management on Disease Resistance of Pomegranate (*Punicagranatum*L.) Orchards” during 2017-18 and 2018-19 at College of Agriculture, Golegaon, VNMKV, Parbhani. The experiment was laid out in randomized block design with seven treatments i. e. T₁- Absolute Control, T₂- Farmer’s Practices (½ RDF), T₃- RDF (625:250:250 g N, P₂O₅, K₂O tree⁻¹), T₄- INM (15 kg FYM + 8 ml *Azotobacter*, 8 ml PSB, 100 g *Trichoderma*+ RDF), T₅- RDF + Antibiotics (Streptocycline @ 250 ppm), T₆- T₄ + Antibiotics, T₇- T₄ + Umber (*Ficusracemosa*)RhizosphereHybridised Soil (URHS @ 25 kg per tree) and four replications. The result showed that maximum DTPA extractable micronutrients content i.e. Fe (5.88 and 4.81 mg kg⁻¹), Zn (1.59 and 1.33 mg kg⁻¹), Cu (4.05 and 3.79 mg kg⁻¹), Mn (12.24 and 11.02 mg kg⁻¹) and available B (1.00 and 0.98 mg kg⁻¹) was recorded at flowering stage in FYM @ 15 kg, *Azotobacter* @ 8 ml per tree, PSB @ 8 ml per tree and *Trichoderma* @ 100 g per tree, 625:250:250 g N, P₂O₅ and K₂O per tree and URHS @ 25 kg per tree (T₇) at 0-22.5 and 22.5-45 cm depth, respectively. Similar trend was noticed at harvesting stage. However, minimum DTPA extractable Fe, Zn, Cu, Mn and available B content was recorded at absolute control.

Keywords: INM, DTPA extractable micronutrients and Pomegranate

3rd International Conference on “Global Initiative in Agricultural, Forestry and Applied Sciences for Food Security, Environmental Safety and Sustainable Development (GIAFAS-2021)”

Studies on performance of different varieties of banana under marathwada region

S.V.Dhutraj¹ and R.V.Deshmukh²

¹Horticulture Banana Research station , Nanded VNMKV,Parbhani

²Plant pathology, Banana Research Station , Nanded,VNMKV,Parbhani

ABSTRACT

A field experiment was conducted during 2017-18 at banana Research Station, Nanded, Studies on performance of different varieties of banana under marathwada region. The field experiment was laid out in Randomized Block Design and replicated seven. The experiment consists of three treatment Viz. V₁- Williams, V₂-Grand Naine, and V₃- Ardhapuri. The growth characters highest height of plant (182.38cm) girth of stem (65.50cm) number of fingers per hand (14.38) was recorded in treatment V₂- Grand Naine. Minimum number of days flowering (210.12 days) and days to harvesting (325.22) and sigatoka incidence (17.16 %) was recorded in treatment V₁. Williams. Significantly maximum weight of finger (138.22g), length of finger (21.39cm) and yield of banana (80.98Mt) was recorded by treatment V₁. Williams variety.

Keywords: Grand Naine, Ardhapuri and Williams

Field evaluation of soil application of biofertilizer for intensity of sigatoka leaf spot and yield of banana

S.V.Dhutraj¹ and R.V.Deshmukh²

¹Horticulture Banana Research station , Nanded VNMKV,Parbhani

²Plant pathology, Banana Research Station , Nanded,VNMKV,Parbhani

ABSTRACT

A field experiment was conducted during 2016-17 at banana Research Station, Nanded to study the effect of soil application of biofertilizer on the intensity of sigatoka leaf spot disease and yield of banana. Three Biofertilizers Viz *Trichoderma harzianum*, *Azospirillum lipoforum* and phosphate solubilizing bacteria (PSB) *Pseudomonas polymixa* were applied through soil at 25 g per plant in split doses. The treatments details were T₁-100 % RDF (Control,) T₂-75 % RDF + *Trichoderma harzianum*, T₃-75 % RDF + *Azospirillum*, T₄-75 % RDF + Soil application of PSB, T₅-75 % RDF + *Trichoderma harzianum* + *Azospirillum* +PSB, T₆-100 % RDF + Soil application of *Trichoderma harzianum*, T₇-100 % RDF + Soil application of *Azospirillum*, T₈-100 % RDF + Soil application of PSB, T₉-100 % RDF + Soil application, *Trichoderma harzianum* +*Azospirillum* +PSB treatment The yield parameters significantly highest number of hands per bunch (9.3), weight of bunch (22.56kg) and banana yield (109.15mt) recorded in treatment T₉ i.e. 100 per cent RDF with soil application of *Trichoderma harzianum* +*Azospirillum* + PSB@25 g per plant. significantly minimum per cent diseases severity index of sigatoka leaf spot (20.92%) by treatment in T₉.

Keywords: Biofertilizer, Banana, Sigatoka, Yield

Effect of different organic fertilizer on growth, yield and quality of brinjal (*solanum melongena* L.) cv. Manjari gota

Ingle, V.V. Bhagat and A. K. Gore

Department of Horticulture, Vasantrao Naik Marathwada Krishi Vidyapeeth, Parbhani., (M.S.). India

ABSTRACT

The present investigation entitled, “Effect of organic fertilizer on growth, yield and quality of brinjal (*Solanum melongena* L.) cv. Manjari gota”. The experiment was laid out under Randomized Block Design in eight treatments with three replications. The treatments were T₁ [RDF 100% through FYM], T₂ [RDF 50% through FYM + 50% through VC], T₃ [RDF 100% through FYM + Jeevamrut (3 application)], T₄ [RDF 50% through FYM + Jeevamrut (5 application)], T₅ [RDF 50% through vermicompost + Jeevamrut (5 application)], T₆ [RDF 100% through VC + biofertilizer 2.5 lit/ha (Azotobacter and PSB)], T₇ [100% RDF+ FYM 5 ton/ha] and T₈[Control].The treatment T₇ [100% RDF + FYM 5t/ha] was found to be superior in the growth parameters such as plant height (22.5, 37.36, 56.5 and 69.76 cm) at 30, 60, 90 and 120 DAT respectively. Number of branches per plant (2.73, 7.33, 12.05 and 16.5 at 30, 60, 90 and 120 DAT respectively while number of leaves per plant (18.2, 37.23, 60.57 and 72.37) at 30, 60, 90 and 120 DAT respectively. The treatment T₇ [100% RDF+FYM 5t/ha] was found with minimum days required for 1st flower to appear on plant (48.15 days), minimum days required for 50% flower to appear on plant (61.48 days) and high number of flowers per plant (65.59) of brinjal. The treatment T₇ [100% RDF + FYM 5t/ha] was found with

3rd International Conference on “Global Initiative in Agricultural, Forestry and Applied Sciences for Food Security, Environmental Safety and Sustainable Development (GIAFAS-2021)”

minimum days required for first harvest of fruit of brinjal (82.77 days), maximum number of fruits per plant (23.92), high yield of fruits per plant (1.45kg) and high yield of fruits per ha (225.58 q/ha). The treatment T₇ [100% RDF+FYM 5t/ha] was found with significantly high percent of TSS (4.97⁰Brix) and ascorbic acid (30.34 mg/100g). Treatment T₇ [100% RDF +FYM 5t/ha] was found with maximum nitrogen percent in plant (3.97%), phosphorus (0.58%) and potassium (1.03%). The treatment T₇ (100% RDF +FYM 5t/ha) recorded maximum net returns (1,37,286 Rs ha⁻¹) and benefit cost ratio (2.55).

Keywords: Organic manures, Inorganic fertilizer, Bio-fertilizer, Growth, Yield and Quality

Morphological characters of French marigold (*Tagetes patula* L.) genotypes

Priya Bhusaraddi, V.V. Bhagat and B. S. Kulkarni

Department of Horticulture, Vasantrya Naik Marathwada Krishi Vidyapeeth, Parbhani., (M.S.). India

ABSTRACT

The present investigation was undertaken to examine the morphological characters of different French marigold genotypes and to know extent of genetic variability present in the population. Correlation and path coefficient analysis between yield and its contributing traits and divergence studies were also done. The experiment laid in Randomised Complete Block Design with 25 genotypes replicated twice. The genotype Pusa Arpita showed maximum plant height (50.54 cm), stem girth (13.35mm), number of primary branches (22.4), leaf length (18.87 cm), leaf width (14.10 cm) and shelf life (4.95 days), IHRFm-411 genotype exhibited higher plant spread (55.57 cm in E-W and 52.27 cm in N-S), number of secondary branches (44.5), flower yield per plant (392.10 g) and flower yield per ha (16.01 ton). Pusa Deep recorded highest number of flowers per plant (170.7), individual flower weight (4.27 g) and flower diameter (45.03 mm) were found maximum in IC-250322-01. UHSFm-10 took minimum days to first flower appearance (26.5 days), UHSFm-8 recorded minimum days to 50% flowering (32.5 days) and flowering duration maximum in IC-250322 (49 days). In genetic variability study higher (> 20%) GCV and PCV were reported for traits plant height, plant spread from east to west and north to south, leaf length, width, stem girth, flower yield per plant and per hectare, individual flower weight and shelf life. The higher broad sense heritability (>60%) coupled with higher (20% and above) genetic advance as percent mean (GAM) was recorded for almost all the parameters except flowering duration.

The significant positive correlation was reported with plant height, plant spread from east to west and north to south, primary and secondary branches, leaf length, leaf width, stem girth, individual flower weight, shelf life, days to first flowering, 50% flowering and flower yield per plant and hectare. In path analysis direct positive association for flower yield per plant was seen with traits plant spread north to south, number of primary and secondary branches per plant, leaf width, individual flower weight, flower diameter, shelf life, number of flowers per plant, days to 50% flowering, duration of flowering and flower yield per hectare.

Keywords: French marigold, Genetic variability, Heritability, Correlation, Path-coefficient

Screening of chickpea genotype for resistance against wilt (*Fusarium oxysporum* f.sp. *ciceri*)

Minakshi Patil and Om Gupta

Department of Plant Pathology, J. N. Krishi Vishwa Vidyalaya, Jabalpur-482004 (MP), India.

ABSTRACT

Development of resistant varieties is the viable strategy to overcome wilt of chickpea caused by *Fusarium oxysporum* f.sp. *ciceri* (Padwick) Synd. & Hans. However, difficulties associated with the development and maintenance of uniform wilt sick plots for screening have hindered the process of developing resistant cultivars. Thus, there is a need for more efficient methods for screening cultivars against the disease. In this regards these resistant sources by screening promising entries will be identified for *F. oxysporum* f. sp. *ciceri* race specific isolates and new variant. Studies on host resistance under multiple disease sick field led to conclusion that among 285 entries two entries showed less than 10 percent mortality and may be considered as resistant, 11 entries exhibited 10.1 to 20 percent mortality and regarded as moderately resistant during 2013-14 however, during 2014-15, six entries showed less than 10 percent mortality and considered as resistant, 14 entries exhibited 10.1 to 20 percent mortality and regarded as moderately resistant.

Keywords: Chickpea, *Fusarium oxysporum* f.sp. *ciceri*, sick field screening, genotype

3rd International Conference on “Global Initiative in Agricultural, Forestry and Applied Sciences for Food Security, Environmental Safety and Sustainable Development (GIAFAS-2021)”

Effect of various mutagenic treatments against *Fusarium oxysporum* f. sp. *ciceri*, causing chickpea wilt

M.G. Patil, V. G. Kasod, C.V. Ambadkar and K.T. Apet

Department of Plant Pathology, V.N.M.K.V, Parbhani-431401(MS), India.

ABSTRACT

Chickpea one of the major pulse crops cultivated and consumed in India and also known as Bengalgram (Patra and Biswas, 2017). Average crude protein content in desi, kabuli and wild species was found to be 25.31%, 24.67% and 24.30%, respectively; total soluble sugars in these genotypes were 38.08, 43.75 and 33.20 mg/g, respectively and total starch content in these genotypes was 34.43, 33.43 and 28.77% (Kaure et al., 2019). *Fusarium* wilt caused by *Fusarium oxysporum* f. sp. *ciceri* (FOC) is one of the most important fungal diseases of chickpea, limit in chickpea productivity in almost all chickpea growing countries across the world. The aim of the present investigation is to use gamma rays and EMS novel technique to induce mutation for identifying resistance or tolerance to *Fusarium* wilt of chickpea by using popular chickpea varieties and comparing them with mutant chickpea. Screening of mutant chickpea was conducted during field screening in sick plot and water culture technique. Hence, the present study was undertaken to explore the possibility of identifying wilt resistant chickpea genotypes.

All four chickpea cultivars tested under wilt sick plot/field were further subjected to the field screening and screening in laboratory by water culture technique. The test mutagens exerted significant effect in chickpea cultivar VIJAY, followed by JG62, BDNG798 and JAKI9218, cv. JG 62 was found highly susceptible with wilt incidence in the range of 97.35 to 100 per cent. Cultivars Vijay and BDNG 798 expressed resistant and moderately resistant reactions against wilt, whereas, cv. JAKI 9218 showed moderately resistant and moderately susceptible reactions against wilt disease in both screening techniques.

Keywords: *Fusarium oxysporum* f. sp. *ciceri*, Chickpea (*Cicer arietinum* L.), mutagens, gamma rays, screening.

Qualitative study of *khoa* produced in major *khoa* producing areas of Marathwada region

Kamble N.S.; Londhe G.K.; S. G. Narwade and B. M. Thombre

Vasantrao Naik Marathwada Krishi Vidyapeeth, Parbhani., (M.S.). India

ABSTRACT

The present study entitled “Qualitative study of *khoa* produced in major *khoa* producing areas of Marathwada region” was undertaken at department of Animal Husbandry and Dairy Science, College of Agriculture, Vasantrao Naik Marathwada Krishi Vidyapeeth, Parbhani. The objectives of this study was to study the methods followed for *khoa* making in *khoa* producing region of Marathwada, study the microbial quality of *khoa* produced in this region., to study the Rheological properties *khoa*, To study packaging practices followed in this region, to find out constraints faced by the *khoa* producers, to study the socio economic status of *khoa* producer and, to study the shelf life of *khoa* at room temperature and at 5°C temperature. It was observed that the lowest score for flavour was gained by sample OV₁ (40.15) and maximum score was observed in sample OV₂ (45.37), for body and texture the lowest score was gained by sample BB₂ (25.12) and maximum score was observed in sample BK₁ (31.37), for colour and appearance lowest score was gained by sample BB₂ (10.62) and maximum score was observed in sample BD₂ (12.12), lowest score was gained for overall acceptability was by sample BB₂ (78.62) and maximum score was observed in sample BK₁ (88.37). In the present investigation the moisture content of market *khoa* samples range from 20.51 per cent in BD₂ to 29.39 per cent in BB₂, fat content of the market *khoa* samples range from 21.17 per cent in OK₁ to 23.55 per cent in BD₂ and BK₂, protein content of the market *khoa* samples range from 15.72 per cent in BK₂ to 21.27 per cent in BD₂, lactose content of the market *khoa* samples range from 26.04 per cent in BB₁ to 34.56 per cent in OB₁, Ash content of the market *khoa* samples range from 3.1 per cent in OK₂ to 3.30 per cent in BD₂, total solid content of the market *khoa* samples range from 70.60 per cent in BB₂ to 79.48 per cent in BD₂, per cent acidity of the market *khoa* samples range from 0.10 per cent in OV₁ and BK₂ to 0.19 per cent in OB₂. There was large variation between the various parameters this might be due to market samples prepared by different peoples and at different places. In the present investigation it was found that total plate count of the market *khoa* samples range from 1.67 x 10⁵ cfu/g in OK₂ to 2.55 x 10⁷ cfu/g in BK₁, the mould count of the samples was found to be negative because it might be due to the samples were tested on the same day, the yeast content of the *khoa* samples range between 10.50 to 124.75 cfu/g. and coliform count of the *khoa* samples range between 3.5 to 8.5 cfu/g. The samples contamination can be attributed to the practice of preparing, unhygienic condition of preparation and water used for washing of utensils, post handling of product enhance the bacterial contamination. Hardness of fresh market *khoa* samples varied from 119g (BB₁) to 33g (OV₁), adhesiveness in market *khoa* ranged from -1 g.s (BD₂) to -8 g.s (OK₁). The adhesiveness was highly significant among the all

3rd International Conference on “Global Initiative in Agricultural, Forestry and Applied Sciences for Food Security, Environmental Safety and Sustainable Development (GIAFAS-2021)”

samples, the values of Cohesiveness in market *khoa* ranged from 1.403 (BB2) to 1.722 (OB2), overall mean values of springiness of market samples of *khoa* which ranged from 1.444 mm (BB2) to 1.537mm (OB2), gumminess of market *khoa* which varied between 0.056 g (OV1) to 0.168 g (BB2). It was observed that there was large variation in adhesiveness, cohesiveness, springiness and gumminess of market *khoa* samples it might be due to different type of milk or mixed milk and also *khoa* prepared by different producers, time of desiccation and the stage at which heating was stopped. It was observed that the shelf life of *khoa* was two days at room temperature and ten days at 5°C temperature.

Keywords: *Khoa, Marathwada, beed, Osmanabad.*

Effect of spacing and leaf cuttings on leaf and seed yield of spinach (*Beta vulgaris L.*) var. All green

V. V. Bhagat, Saba sheikh Najeer and A. S. Lohakare

Department of Horticulture, Vasanttrao Naik Marathwada Krishi Vidyapeeth, Parbhani., (M.S.). India

ABSTRACT

The experiment was laid out in Factorial randomized (FRBD) with three spacing (15, 30 and 45 cm row to row) and four cuttings (no cutting, one cutting, two cuttings and three cuttings). Maximum mean height of palak was recorded in 15 cm spacing (51.80 cm), in no cutting (77.20 cm). Maximum number of leaves was recorded in 45 cm spacing (17.75) and in no cutting (18.33). As regards length of petiole maximum length of petiole was observed in 45 cm spacing (12.45 cm) where as maximum petiole length was recorded by no cutting (15.06). Maximum stem girth was found in 45 cm spacing (1.502) and in one cutting (1.526) Interaction combination of one cutting with 45 cm spacing recorded maximum stem girth. Maximum leaf area per plant was recorded in 45 cm spacing (647.76) and in no cutting (907.31). Green yield per plant was maximum in 45 cm spacing (39.11 g) and in three cutting (67.94 g). Yield per plot and per hectare were medium in 15 cm spacing (7.32 kg and 108.10 q/ha respectively). Green yield per plant 67.94 g, per plot and per hectare was observed in three cuttings i.e. 9.98 kg and 147.36 q/ha respectively. Interaction combination i.e. three cuttings with 15 cm spacing produced maximum green yield per plot (13.40 kg) and per hectare (197.93 q). Maximum seed yield per plant was obtained in 45 cm spacing. As regards cutting maximum seed yield per plant was recorded in one cutting treatment (6.38 g). Similarly maximum seed yield per plant was recorded in treatment combination i.e. one cutting with 45 cm spacing (6.52 g). Per plot and per hectare seed yield was maximum in 15 cm spacing i.e. 1.29 kg and 19.07 q. Post harvest observations weight of 1000 seeds Maximum weight of 1000 seed was in 45 cm spacing (14.62 g) and in no cutting (14.91 g). More germination percentage was observed in 45 cm spacing 74.03 %. As regards cuttings one cutting recorded maximum germination percentage of 75.79%.

Keywords: Spacing, Cutting, Interaction, Seed yield, Green yield, Palak (*Beta vulgaris L.*)

Effect of different seed rates and spacing on Growth, yield attributes and grain yield of rice

D. C. Lokhande

Paddy Research Scheme farm, VNMKV Parbhani

ABSTRACT

A field experiment was conducted at Upland Paddy Research Scheme farm, VNMKV Parbhani during *kharif* 2012. The soil was low in available nitrogen, medium in phosphorus, high in potassium and low in ferrous sulfate. The experiment was laid out in split plot design with fifteen (15) treatment combinations and three replications, with five seed rates in main plot i.e. 25 kg/ha, 30 kg/ha, 35 kg/ha, 40 kg/ha and 60 kg/ha and three spacing in sub plot i.e. 20 cm, 25 cm, 30 cm. The rice variety ‘Avishkar’ was sown in first week of July, 2012. Among the different seed rates, higher seed rate of 60 kg/ha showed significantly taller plants than rest of the lower seed rates. The seed rate of 35 kg/ha recorded the higher mean number of functional leaves/plant and mean number of tillers/m² over the rest of the seed rates. However, it was at par with seed rate 30 kg/ha for number of functional leaves per plant. The maximum leaf area per plant was at the seed rate of 30 kg/ha at all growth stages and was followed by the seed rate of 35, 40 and 60 kg/ha. Significantly maximum panicle weight, filled grains/panicle and least number of unfilled grains/panicles were observed in the lower seed rate of 25 kg/ha, except for panicle weight with 30 kg/ha and 35 kg/ha of seed rates and number of filled grains with 30 kg/ha of seed rate. However, mean number of panicles/m² were maximum under 35 kg/ha and was at par with 40 and 60 kg/ha of seed rates. The maximum grain yield (3145 kg/ha) and NMR (Rs. 30232) was obtained with 35 kg/ha of seed rate. However, it was at par with seed rates 30, 40 and 25 kg/ha for grain yield and with 30 kg/ha seed rate for NMR. The highest B:C ratio obtained from the seed rate of 35 kg/ha (3.02) and was closely follow by 30 kg/ha (2.97).

3rd International Conference on “Global Initiative in Agricultural, Forestry and Applied Sciences for Food Security, Environmental Safety and Sustainable Development (GIAFAS-2021)”

Wider spacing (30 cm) produced significantly more plant height, leaf area/m² and number of tillers/m² than rest of the closer spacing under study. Similarly the spacing of 30 cm gave significantly more panicle weight, number of panicle/m² at harvest than both the closer spacing of 25 cm and 20 cm. This ultimately resulted into higher grain (3065 kg/ha), straw (4045 kg/ha) and biological yield (7110 kg/ha) under the wider spacing (30 cm) than both the closer spacings (25 cm and 20 cm). The highest Net Monetary Returns of Rs. 27139 and B:C ratio (2.91) was observed with the spacing of 30 cm followed by 25 cm (RS. 2371 and 2.59) and 20 cm (RS. 18469 and 2.22), respectively.

Keywords: Direct seeded rice, seed rate, spacing, Optimum seed rate and spacing under upland drilled irrigated rice (aerobic).

Influence of some micro-nutrients management practices on rice yield

D. C. Lokhande

Upland Paddy Research Scheme, Vasantrao Naik Marathwada KrishiVidyapeeth, Parbhani -431402

ABSTRACT

A field experiment was conducted in medium black soil with slightly alkaline in reaction in 2011, 2012 and 2013 at Upland Paddy Research Scheme, research farm, VNMKV, Parbhani (Maharashtra). Rice variety ‘Parag’ was sown with 30 cm row spacing and 60 kg seed rate/ ha. Experiment was laid out in randomized block design with three replications. Ten treatments were tested viz., N-P-K only 80-50-50 kg/ha (recommended dose of fertilizer-RDF) (N₁), NPK (RDF)+ ZnSO₄ @10 kg/ha through soil (N₂), NPK (RDF)+ ZnSO₄ @10 kg/ha + FeSO₄ @10 kg/ha thorough soil (N₃), farm yard manure (FYM) @ 5 t/ha + NPK (RDF) (N₄), FYM @ 5 t/ha + NPK (RDF) + ZnSO₄ @10 kg/ha thorough soil (N₅), FYM @ 5 t/ha + NPK (RDF) + ZnSO₄ @10 kg/ha + FeSO₄ @10 kg/ha thorough soil (N₆), NPK (RDF)+ Two foliar sprays of ZnSO₄ @ 0.5% at 20 and 45 DAS (N₇), NPK (RDF)+ Two foliar sprays of ZnSO₄ @ 0.5% + FeSO₄ @ 0.5% at 20 and 45 DAS (N₈), FYM @ 5 t/ha + NPK (RDF)+ Two foliar sprays of ZnSO₄ @ 0.5% at 20 and 45 DAS (N₉) and FYM @ 5 t/ha +NPK (RDF)+ Two foliar sprays of ZnSO₄ @ 0.5% + FeSO₄ @ 0.5% at 20 and 45 DAS (N₁₀). Soil was low in nitrogen, ferrous and zinc; medium in phosphorous and rich in potash. Rainfall during experimental period was 636 mm, 678 mm, 1134 mm in cropping season during 2011, 2012 and 2013, respectively. In pooled analysis the significantly highest rice seed yield was obtained when recommended dose of N-P-K (80 - 50 - 50 kg/ha) and farm yard manure @ 5 t/ha with soil application of both the micronutrients i.e. FeSO₄ and ZnSO₄ @ 10 kg/ha (N₆) was used, however, it was on par with recommended dose of fertilizer and farm yard manure with two foliar applications of both the micronutrients i.e. FeSO₄ and ZnSO₄ at 20 and 45 DAS (N₁₀) and use of recommended dose of fertilizer and soil application of both the micronutrients i.e. FeSO₄ and ZnSO₄ @ 10 kg/ha (N₃). However, significantly highest net monetary returns were obtained with the application of N-P-K @ 80-50-50 kg/ha, respectively, with FeSO₄ and ZnSO₄ through soil @ 10 kg/ha than rest of the nutrient management treatments in 2011, 12 and 13.

Keywords: Drilled/direct seeded upland rice, Fe and Zn management in rice, INM in upland drilled rice.

Studies on Preparation of Lassi Blended with Biofortified Sorghum (Parbhani Shakti)

Sawant V.Y.; Londhe G.K and Kamble N.S.

College of Agriculture, Vasantrao Naik Marathwada krishi Vidyapeeth, Parbhani

ABSTRACT

The research work entitled “Studies on Preparation of Lassi Blended with Biofortified Sorghum (Parbhani Shakti)” was undertaken at department of Animal Husbandry and Dairy Science, College of Agriculture, Vasantrao Naik Marathwada krishi Vidyapeeth, Parbhani. The objectives of the project were to develop process for preparation of lassi blended with biofortified sorghum, to study physico-chemical and sensory of sorghum lassi, to study shelf life of developed product and to estimate the cost of developed product. Buffalo milk was filtered and standardized to 6 per cent fat. It was pasteurized at 80 OC for 10 minutes. Sorghum flour was added slowly thoroughly heating at 70OC. Milk was cooled to room temperature. Active culture (ncdc-167) was inoculated under aseptic conditions at the rate of 1.5 per cent and mixed thoroughly. The inoculated milk was incubated at 37OC temperature for 12 hrs. Dahi was obtained after that dahi was broken down; water 20 per cent and sugar 10 per cent of dahi and water were added into it for the preparation of biofortified sorghum lassi. Level of water and sugar were optimized by sensory test on 9 point hedonic scale by semi expert panel of judges. The ten per cent level of water got highest sensory score hence this level was chosen for addition to dahi while preparing experimental lassi. The addition of 10 per cent sugar for preparing lassi was finalized. Buffalo milk samples used in this study contained on an average 3.9, 6.0, 84.2, 0.80, 15.9 per cent protein, fat, moisture, ash, total solids, respectively. Sorghum flour of Parbhani shakti

3rd International Conference on “Global Initiative in Agricultural, Forestry and Applied Sciences for Food Security, Environmental Safety and Sustainable Development (GIAFAS-2021)”

variety was used. Parbhani shakti variety contains Protein 10.38, carbohydrate 71.02, moisture 8.2, ash 1.46 fat 1.8, 45 ppm iron and 32 ppm zinc. Treatments were in T1 - 100 Parts of milk , T₂- 2 Parts of sorghum flour ,T₃ - 4 Parts of sorghum flour ,T₄ - 6 Parts of sorghum flour and T₅ 8 Parts of sorghum flour. While studying sensory properties of lassi it was observed that the mean score for body and texture of *lassi* extended from 9.00 to 7.06. The score acquired for treatment T1, T2, T3, T4 and T5 was 9.00, 8.95, 8.34, 7.51 and 7.06, respectively. The lowest colour and appearance score was recorded for treatment T5 (6.99) while, highest was obtained for T1. Flavour score was uppermost in T1 (9.00) and bottommost for T5 (7.10). The lowest score of overall acceptability was recorded for treatment T5 (8 per cent flour) and the highest overall acceptability score was recorded for treatment T1 (Control with 100 parts of milk). The highest protein 4.41 % was observed in T5 while lowest 3.90 % was observed in T1. Lowest fat content was observed for T5 and highest in treatment T1 which was incorporated with eight parts of flour. per cent respectively. The lowest ash content was observed in control sample while highest ash content was noticed in sample treated with eight parts of sorghum flour. The lowermost carbohydrate 5.16 was observed in T0 while, maximum 10.34 was observed in T5 respectively. Lowest total solid content (15.86per cent was observed in control sample while the highest total solid content 21.10per cent was for T5. ely. Lowest moisture content of was found for T5while, highest moisture content was observed in T1. The highest zinc content was observed in T5 while, lowest was observed in T1. The highest iron content was observed in T5while lowest was observed in T1. It is also observed that the lowest pH content was in T5 and the highest was found in T1. Highest value for acidity was observed in treatment T5 while lowest in treatment T1. The highest fat content was recorded for treatment T1 (5.19) and lowest fat content was recorded in treatment T5 (3.82). The highest protein content was noted for treatment T5 (4.22) and lowest fat content was recorded in treatment T1 (3.44) respectively. Highest ash content was observed in treatment T5 (0.76) while lowest ash content was in treatment T1 (0.68). Ash content of *lassi* increased with increased in proportion of sorghum flour. The highest value of carbohydrate content was recorded for treatment T5 (16.27 per cent) and lowest value was for treatment T1 (14.28 per cent). The lowest total solid contents was recorded for treatment T1 while highest total solid content was noticed for treatment T5. . The Moisture content was lowest in T5 (74.93) and highest in T1 (76.42). The zinc content was lowest in T1 (3.63 ppm) and highest in T5 (6.11 ppm). It was also observed that the zinc content was in increasing order from treatment T1 to T5 4.39 and 5.24 ppm respectively. It is evident that average iron ppm was increased from T1to T5. The iron content was highest in T5 (5.24 ppm) and lowest in T1 (1.92 ppm). It was found that total standard plate count of fresh *lassi* sample was 1.2×10³ and yeast and mould as well as coliform count was nil. While, on 9th day SPC count was 29.5×10³ CFU/ml while yeast and mould count was 4.45 ×10³ CFU/ ml and coliform count was nil. Wheying off was noticed on 7th day. The *lassi* made by addition of two 2 parts of sorghum flour among the treated examples got most elevated score for flavor, body and texture, colour and appearance and in general adequacy was liked very much. Although there was decrease in sensory score with increase in flour, there was significant increase in nutritional quality of *lassi*.

Keywords: *Lassi, Parbhani shakti, fortified,*

Roasted soybean: As influenced by quality parameters and sensory evaluation of soy flour

S.B. Jadhav and M.M.Nirva

College of Agriculture, Ambajogai, Beed, Dept. of Agril. Process Engineering, CAE & T, VNMKV, Parbhani

ABSTRACT

The experimental research work was carried out at the department of Agricultural Process Engineering, CAE & T, VNMKV, Parbhani (Maharashtra) to study the quality parameters, anti-nutritional factors and sensory evaluation of soy flour prepared from roasted soybean. Soybean variety JS -335 was selected for the study on the basis of popularity and yield. Soybean was procured from Soybean Processing Center, VNMKV, Parbhani. Whole unbroken soybean free from infestations was selected for study purpose. The roasted soybeans were milled to obtain soy flour. Evaluation of quality parameters viz., moisture content, protein content, bulk density, dispersibility, water absorption capacity and color of soy flour samples was performed as per the standard procedures. Moisture content, bulk density and colour of roasted soy flour decreased with increase in roasting time. The protein content, dispersibility and water absorption capacity increased with increase in roasting time.

Keywords: soy flour, anti-nutritional factors, roasted soybean

3rd International Conference on “Global Initiative in Agricultural, Forestry and Applied Sciences for Food Security, Environmental Safety and Sustainable Development (GIAFAS-2021)”

Evaluation soy flour samples prepared from different methods

S.B. Jadhav and M.M.Nirval

College of Agriculture, Ambajogai, Beed, Dept. of Agril. Process Engineering, CAE & T, VNMKV, Parbhani

ABSTRACT

The evaluation of proximate composition of soy flour samples prepared from different methods was carried out at the department of Agricultural Process Engineering, CAE & T, VNMKV, Parbhani (Maharashtra). Soybean variety JS -335 was selected for this study. Soybean was procured from Soybean Processing Center, VNMKV, Parbhani. Whole unbroken soybean free from infestations was selected for study purpose. Evaluation of proximate composition viz., moisture content, protein content, fat content, fiber, ash and carbohydrate was performed as per the standard procedures. Significant difference was found within the treatments i.e. soy flour prepared from raw soybean, 45 min roasted soybean, 60 min boiled soybean and 4 hr soaked and 60 min boiled soybean. Roasting, boiling and soaking and boiling showed significant effect on the protein content of soy flour samples. The highest fat content observed in soy flour prepared from 45 min roasted soybean i.e. 19.48 %. Statistical results also indicated that processing methods like boiling, roasting and soaking and boiling significantly affected the fiber content of soy flour samples. The ash content was found to be the highest in raw soy flour i.e. 5.46 % and lowest for soy flour prepared from 4 hr soaked and 60 min boiled soybean i.e. 4.83 %. The carbohydrate content was highest for soy flour prepared from 4 hr soaked and 60 min boiled soybean i.e. 29.46 % and lowest for soy flour prepared from 45 min roasted soybean i.e. 26.06 %.

Keywords: soy flour, roasting, boiling, soaking

Expression of regucalcin, a calcium binding protein is regulated by Hypoxia inducible factor-1alpha

Tripti Singh, Pallabi Banerjee, Anshuman Chandra, Nagendra Singh and Imteyaz Qamar

School of Biotechnology, Gautam Buddha University, Greater Noida, U.P.- 201312 (India)

ABSTRACT

Regucalcin (RGN) has cytoprotective effects reducing intracellular levels of oxidative stress, also playing a role in the control of cell survival and apoptosis. Previously, RGN and HIF-1 α expression was also reported to be upregulated in hypoxia. Interestingly hypoxic induced RGN expression in a fashion similar to that of HIF-1 α expression in rat lungs. Sequence analysis of the RGN promoter region revealed the presence of putative HRE binding motifs. Further analysis of the 1 kb RGN promoter region with 5' deletion and point mutants of HRE binding motif showed that the HRE binding site was critical for high promoter activity. In addition, HIF-1 α protein binds directly to the HRE binding motifs within the RGN promoter in vivo, and regulates RGN gene expression. All together, these findings suggest that RGN is the novel target gene of HIF-1 α and that RGN gene expression in hypoxia may be regulated by the control of HIF-1 α expression.

Influence of different chemicals on yield and quality of mango (*Mangifera indica* L.) cv.Kesar

A.S. Lohakare*, V.V. Bhagat and S. Ambrish

Vasantrao Naik Marathwada Krishi Vidyapeeth, Parbhani

ABSTRACT

An exogenous application of various chemicals like PAs (Putrescine 0.1mM and Spermine 0.01mM), Triacantanol 750 ppm, NAA 25 ppm, CPPU (Forchlorfenuron) 3 ppm, Salicylic acid (SA) 100 ppm, Zinc sulphate (ZnSO₄) 0.5 % and Boron (B) 0.5 % were sprayed at different stages on mango trees cv. Kesar to investigate their effect on yield and quality. The result revealed that significant highest number of fruits per tree (281.00), highest fruit weight (239.36 g), fruit yield per tree (69.21 kg), fruit firmness (14.67 kg/cm²), pulp weight (164.71 g), TSS (19.66%), Ascorbic acid (46.14 mg 100 g⁻¹), Total sugars (13.13%), Sugar: acid ratio (55.98) and similarly the lowest acidity (0.24%) was also recorded in treatment T₇ i.e. NAA 25 ppm + SA 100 ppm + ZnSO₄ 0.5%. The maximum pulp-stone ratio (4.04) was recorded in treatment T₁₄ i.e. CPPU 3 ppm + SA 100 ppm + B0.5%. Whereas, lowest yield and quality was observed in treatment T₁₉ (control).

Keywords: Mango, Kesar, yield, quality, chemicals.

3rd International Conference on “Global Initiative in Agricultural, Forestry and Applied Sciences for Food Security, Environmental Safety and Sustainable Development (GIAFAS-2021)”

COMPARATIVE EVALUATION OF INTERCROPPING OVER MONOCROPPING WITH REFERENCE TO RESOURCE USE EFFICIENCY AND MONETARY ADVANTAGE

Barkha

Dept. of Agronomy, School of Agriculture, Lovely Professional University, Punjab

ABSTRACT

As India races towards becoming one of the largest economies in the world, growth in its agriculture sector must be ensured. But, the current scenario of farmer's distress in our country is taking a toll on farmer's lives as well as agricultural economy of India. Thus, to cope with this situation, our government has set a goal of doubling farmer's income by various approaches. Adoption of intercropping is one such tool which can aid in achieving this goal. Intercropping *i.e.*, cultivating two or more crops in the same space/field at the same time, can help in achieving higher productivity per unit area in addition to stability in production. Intercropping systems may improve stability in production through more consistent yield and efficient use of the resources as well as reductions in the input cost. Intercropping also provides ground cover for a longer period of time over monocropping systems which ultimately leads to soil conservation. As a result of growing more than one crop at a time in the same field, farmers can maximize water use efficiency, maintain soil fertility and minimize soil erosion, which are the serious drawbacks under the mono-cropping system. Under multiple cropping systems like intercropping, benefits are achieved by the suitability of the crops growing together, not by the means of costly inputs. Intercropping can also provide social benefits to both the land holder and the surrounding community.

Effect of Fertility Levels of Nitrogen and Weed Management Practices on Growth and Yield of Wheat (*Triticum aestivum* L.)

Saif Alam Khan, Sirazuddin, Roop Kishore Sharma and *Moinuddin

Doon (P.G) College of Agriculture and Allied Science, Dehradun, Uttarakhand (India)

**Shri Guru Ram Rai University, Dehradun, Uttarakhand (India)*

ABSTRACT

A field experiment was conducted during *Kharif* seasons 2020-2021 at Crop Research Farm, Doon (P.G) College of Agriculture and Allied Science, Dehradun, Uttarakhand to find out the weed management practices on growth, yield and economics of wheat (*Triticum aestivum*) under varying fertility levels. The results revealed that among various weed management practices, the formation of pendimethalin + sulfosulfuron recorded significantly lower weed dry matter, higher weed control efficiency, higher values of yield attributes, seed and biological yield during the year of experiment over rest of the treatments except sequential application of pendimethalin + one Hand Weeding which was statistically at par. Further, application of pendimethalin also gave comparable results with pendimethalin + sulfosulfuron in terms of weed control efficiency and yields. Nitrogen fertilization at 187.5 kg/ha significantly improved the weed biomass, weed control efficiency, nutrient depletion, grain yield, straw yield and nutrient uptake by wheat crop over the preceding levels. However, it remained statistically at par with 187.5 kg N/ha

Key Words: Growth, Herbicides, Nitrogen, Weed, Wheat and Yield

Study the size of planting material (single node cutting) and spacing on growth and yield of turmeric

Radhajogita Mondal¹ and J. K. Hore²

Lovely Professional University

Bidhan Chandra Krishi Viswavidyalaya

ABSTRACT

Turmeric (*Curcuma longa* L.) is a herbaceous perennial plant, belongs to the family Zingiberaceae. Turmeric the ancient and sacred spice of India known as 'Indian saffron'. Turmeric is prized and valued for its ability to impart brilliant yellow-golden colour to food due to the presence of curcumin. Turmeric has a lot of medicinal properties. It is known for its anti-mutagenic, anti-carcinogenic, antioxidant and chemotherapeutic properties. The present investigation was undertaken with the following objective - to study the size of planting material (single node cutting) and spacing on growth and yield of turmeric. A field experiment with four types of seed rhizome (single node 4 g, 8 g, 12 g and multiple nodes; 20-25 g) and three spacing (20 x 15 cm, 25 x 20 cm and 30 x 25 cm) was laid out in split-plot design with three replication, assigning spacing to the main plot and seed rhizome size to the sub-plots of turmeric cv. Suguna. Among different treatment combination, maximum plant height (159.62 cm), number of tiller per plant (1.74), weight of clump (175.45), yield per plot (13.64 kg 3m⁻²), projected yield (34.1 t ha⁻¹) under 20 x 15 cm spacing and 12 g seed rhizome.

3rd International Conference on “Global Initiative in Agricultural, Forestry and Applied Sciences for Food Security, Environmental Safety and Sustainable Development (GIAFAS-2021)”

Assessment of Suitable Clones of Eucalyptus for Eastern Uttar Pradesh, India

Anubha Srivastav, S. D. Shukla & Yogesh Kumar Agarwal

Forest Research Centre for Eco-rehabilitation, Prayagraj (A Centre of ICFRE, Dehradun),

ABSTRACT

The adoption of *Eucalyptus* plantations in agroforestry is much prevalent in the region of Eastern U.P. To promote these plantations commercially, choice of planting material is a challenging task for farmers. As clonal forestry of *Eucalyptus* is now quite popular in the region, thus, selection of adequate clones for specific region is very important to gain maximum yield of end produce. Therefore, with a view to identify promising clones for three agro-climatic zones viz. Eastern Gangetic plains, Vindhyan region and Tarai region of Eastern U.P., experimental trials were established in 05 districts -Prayagraj, Gorakhpur, Pratapgarh, Raebareilly and Mirzapur with a view to assess site-specific adequate clones with 19 commercial clones of *E. hybrid*, *E. camaldulensis* and *E. tereticornis* (413, 07, 526, 04, K-25, 288, 2013, 2023, 2070, 2136, 3018, 3021, P-13, P-14, P-23, P-32, P-45, P-50, P-66), 10 IFGTB clones of *E. camaldulensis* (IFGTB- 1,2,3,4,5,6,7,8,9 and 10) and 3 FRI clones of *E. camaldulensis* (DDN-100,104 and 124) in the year 2016 and 2017. The performance of clones was assessed annually for height and girth at breast height (gbh). The mean annual increments in height and gbh were calculated. The analysed results after 3-4 years of planting showed that in Vindhyan region (District- Prayagraj and Mirzapur), the clones P-13,P-23,P-32,526, P-50, FRI-100 and 124, IFGTB-2,3,7,6 and 9 performed well over others. Similarly, in Eastern Gangetic plains (District-Raebareilly and Pratapgarh), the clones P-50,07, P-45,413, 288, FRI -100, FRI- 124, IFGTB-1,2,6,8,10 and in Tarai region (District-Gorakhpur), the clones P-14, P-15, 07, 2013, 526, FRI-100, FRI-124 and IFGTB- 1,5, 6, 9 and 10 performed well over others. Further, the assessed promising clones will be helpful for farmers / tree growers in selection of adequate quality planting material for *Eucalyptus* based agroforestry in the region.

Keywords: Commercial agroforestry, *Eucalyptus* based, agro-climatic zones, suitable clones, economic gain

Investigating the impact of diethyl sulphate in banana (*Musa paradisiaca*) cv. Grand Naine

Rajni Rajan¹ and M Feza Ahmad²

¹Department of Horticulture, School of Agriculture, Lovely Professional University, Phagwara-144 401

²Department of Fruit and Fruit Technology, Bihar Agricultural University, Sabour-813 210

ABSTRACT

The greatest significant constraint of agricultural production worldwide remains to be abiotic stress. Salinity is one of the most significant hurdles among the multiple abiotic stress factors. The biggest problem in the flood-prone area of North Bihar is drainage. A lack of drainage that may over time render the land inappropriate for farming aggravates salinity. As most banana cultivars are susceptible to salt, better knowledge of the genetic controlling of stress reactions generated by salt could help to improve crop development in the future generation. In order to create salt tolerant mutants in the banana cv. Grand Naine, which are using chemical mutagens, research was undertaken in the Horticulture Division (BAU) of Sabour in 2017-2020. The DES LD50 was reported at 5.1 mM for shooting banana culture. Until M1V2, DES retained sleeping state. Shoot length and root length of morphological characteristics like DES @ 3 mM were determined to be maximal (4.40 cm), root length (5.30 cm). Based on our findings, we believe that using DES as a chemical mutagen in banana development can result in the production of desirable traits and crop improvement.

Keywords- Salinity, Banana, DES, Chemical, Mutagen

Precision Farming in Indian Agriculture

Harish Kumar Bijarnia

Department of Agronomy, Rajasthan College of Agriculture, MPUAT, Udaipur

ABSTRACT

Precision farming revolves around the idea that any agricultural land can contain wide spatial variations in soil types, nutrient availability, and other important factors and not taking these variations into account can result in a loss of productivity. Precision farming is form of farming where site-specific management practices are adopted giving due consideration to spatial variability of land to maximize crop production and minimize environmental damage. Precision farming t is a system approach which attempts to reduce decision uncertainty through incorporating information about spatial and temporal variability into the decision making process. It is a system approach which improves farm productivity, soil and environmental quality, the field of precision agriculture has

3rd International Conference on “Global Initiative in Agricultural, Forestry and Applied Sciences for Food Security, Environmental Safety and Sustainable Development (GIAFAS-2021)”

been emerged. The idea is to know the soil and crop characteristics unique to each part of the field and to optimize the production inputs within small portions of the field. The philosophy behind precision agriculture is that production inputs (seed, fertilizer, chemicals etc.) should be applied only as needed and where needed for the most economic production.

Keywords: Precision farming, Crop production, Environmental damage

Small and Marginal Farmers in GPS, GIS and Precision Agriculture in India

Shankar Lal Bijarnia and Harish kumar Bijarnia

Department of Soil Science and Agricultural Chemistry, SKRAU, Bikaner

Department of Agronomy, Rajasthan College of Agriculture, MPUAT, Udaipur

ABSTRACT

In the present-day context of changing information needs of the farmers and diversified production systems there is an urgent need to look for the effective extension support system for the small and marginal farmers in the developing countries like India. The rapid developments in the collection and analysis of field data by using the spatial technologies like GPS & GIS were made available for the extension functionaries and clientele for the diversified information needs. This article describes the GIS and GPS based decision support system in precision agriculture for the resource poor farmers.

Precision farming techniques are employed to increase yield, reduce production costs, and minimize negative impacts to the environment. The parameters those can affect the crop yields, anomalous factors and variations in management practices can be evaluated through this GPS and GIS based applications. The spatial visualisation capabilities of GIS technology interfaced with a relational database provide an effective method for analysing and displaying the impacts of Extension education and outreach projects for small and marginal farmers in precision agriculture. This approach mainly benefits from the emergence and convergence of several technologies, including the Global Positioning System (GPS), geographic information system (GIS), miniaturised computer components, automatic control, in-field and remote sensing, mobile computing, advanced information processing, and telecommunications.

Key words GIS, GPS, Spatial data analysis India, small and marginal farmers

Impulsion of agriculture polytechnic students

SHELKE R.A.*¹, GOHAD V.V.², NIRPAL R. S.³

SHUATS, Prayagraj (UP)

Shri Shivaji Agriculture collehe Amravati (MH)444601

Mahatma Phule Krishi Vidyapeeth, Rahuri, Ahamadnagar (MH)413722.

ABSTRCAT

True education releases capacities; develop analytical abilities, confidence, will power and goal setting competencies. It will also serve as self-motivating agent of social change. Learning has to create path way to knowledge which continues to evolve throughout the course of one's life is yet another grand objective. Education is the process of bringing about desirable changes in the behavior of an individual. It is the basic process required for all-round development of personality of an individual. It is rightly said that education is the lifeline of development, be it spiritual or economics, scientific or technological, national or global. The present study was conducted in the agriculture polytechnic schools under Dr. Panjabrao Deshmukh Krishi Vidyapeeth, Akola. A randomly lottery method was used to select the students from the selected schools and made the sample of about 100 students. The data collected with the structural schedule and processed with using statistical methods.

The study revealed that majority of students studying in polytechnic schools were male (68.00%) and remaining were female. The majority of pupils are from rural backgrounds, with the remainder from semi-urban and urban areas. The majority of pupils received a first-class grade, followed by a second-class grade, a pass, and a distinction. The majority of students had semi-medium land holdings, followed by medium, large, small, marginal, and landless land holdings, majority of students had a medium level of family education, majority of students had their parents main occupation of farming, followed by business, service, dairy farming, labour, majority of students had their parents main occupation of farming, followed by medium, large, small, marginal, and landless land holdings, majority of students had their parents main occupation of farming, followed by medium, large, small, marginal, The research explained that majority of students have low or bad response to the institutional impact followed by the medium and good responses. Poor institutional impact at Agriculture Polytechnic Schools, a lack of educational tours, a lack of books available in the library to students, a lack of discussion on agriculture in relation to current

3rd International Conference on “Global Initiative in Agricultural, Forestry and Applied Sciences for Food Security, Environmental Safety and Sustainable Development (GIAFAS-2021)”

events, a lack of priority given to competitive exams, a lack of sports education, a lack of agricultural magazines, a lack of audio-visual aids to study, a lack of actual training for students, and a lack of internet were among the challenges faced by students.

Keywords – Aspiration, Agriculture Polytechnic School, Amravati.

Impact analysis of onion varieties in Maharashtra.

R. S. NIRPAL¹, R.A. SHELKE², V.G.POKHARKAR³ · S.R.RAUT⁴

Mhatma Phule Krishi Vidyapeeth, Rahuri, Ahamadnagar (MH)413722.
SHUATS, Prayagraj (UP).

Mhatma Phule Krishi Vidyapeeth, Rahuri, Ahamadnagar (MH)413722.

Mhatma Phule Krishi Vidyapeeth, Rahuri, Ahamadnagar (MH)413722.

ABSTRACT

Horticulture is fast growing sector in Indian agriculture, because a percentile has been established change in consumption pattern characterized by decline in share of food-grains and increasing share of non-food grains products in the consumption baskets particularly fruits and vegetables. The goal of an economic impact assessment is to predict how a proposed project or programme will affect employment, income, and levels of business activity (usually measured in gross receipts or value added). A basic method for evaluating the economic consequences of minor changes in a farming business is partial budgeting. This tool compares the benefits and costs of implementing the alternative to the current practise. The varieties developed by Onion research scheme, Pimpalgaon Baswant and onion storage scheme under Mahatma Phule Krishi Vidyapeeth, Rahuri. have dominated the onion area in Maharashtra. So, these two research stations were deliberately pick-out for research purpose. These varieties are Baswant-780, N-2-4-1, Phule safed, Phule Samarth; Phule Suvarna. The total additional cost (direct and indirect) of university-released onion varieties over competing local varieties is Rs 25079.75 per hectare. However, the RS 71445.47 difference in costs (or savings) and a return due to university-released onion varieties over competing varieties were due to the university-released onion varieties. As a result, the total economic worthiness of the university-released onion production technology in comparison to other competing onion varieties in the region was Rs 46365.72 per hectare.

Keywords: Partial budgeting direct cost, Farming business, Impact assessment.

Doubling Indian farmers’ income: a challenge

Bhartendu Yadav

Chandra Shekhar Azad University of Agriculture & Technology, Kanpur

Introduction:

As India marks 50 years of the Green Revolution this year, the Indian farmers are still facing crisis. Farming is the most important enterprise in India and farmers are an integral part of our country. To address the agrarian crisis and farmer’s unrest across the country, there should be several steps which the government needs to take to secure farmer’s income.

Statistics:

The average monthly income of the Indian farm household was estimated to be about Rs. 6,426 (70th, NSS). This included net receipts from cultivation, farming of animals, non-farm business and income from wages. During the same period, the average monthly consumption expenditure per agricultural household was Rs 6223. Farmers are mostly dependent on loans and the *NSSO survey* revealed that half of the farm households were neck-deep in debt. As per the *Agriculture Census 2010-11*, 67.10% of India’s total farmers are marginal farmers (below 1 ha) followed by small farmers (1-2 ha) at 17.91%. Indian agriculture is dominant by marginal farmers who have small holdings, raising productivity of this group is most important if income of this group need to be double. Professor M.S. Swaminathan, founder of the M.S. Swaminathan Research Foundation noted that it was high time that the recommendations of the National Commission on Farmers to provide the minimum price of the total cost of production plus 50% are implemented.

Ways to improve the income of farmers:

MSP and procurement are one of the ways to improve farmer’s income. There is need to improve productivity. The marketable surplus from agriculture has to be enhanced. Need to look at making a value addition to biomass. Addressing the ecological challenge requires more technology while the economics requires more public policy interventions.

3rd International Conference on “Global Initiative in Agricultural, Forestry and Applied Sciences for Food Security, Environmental Safety and Sustainable Development (GIAFAS-2021)”

Governments steps to increase farmers’ income:

Remunerative prices for farmers by reforming the existing marketing structure;
Raising productivity;
Reforming agriculture land policy; and
Relief measures.

Conclusion:

Government needs to take long-term steps to ensure the economic viability of farming. Raising productivity, reforming land policies and solving remunerative price mess will require massive amount of public investment and political will.

References:

<https://www.nabard.org/auth/writereaddata/tender/0301190011Maharashtra's%20Report.pdf>
<https://www.agricoop.gov.in/sites/default/files/DFI%20Volume%204.pdf>
<https://indianexpress.com/article/opinion/columns/why-doubling-farmers-income-by-2022-is-possible-2754028/>
<https://www.thehindubusinessline.com/opinion/five-ways-to-double-farmers-income/article23827672.ece>

Recent trends and past perspectives in Hybrid Seed Production in Wheat

Ankit Jaiswal¹ and Yuvraj Yadav^{2*}

Department of Agriculture, Himalayan College, Roorkee

ABSTRACT

Nowadays, there is an era of hybrid seed production in self as well as cross pollinated crops to meet the demand of global food security. However, development of hybrids in self-pollinated crops particularly in cereals has not been successful so far. There were several modes of boosting the yield in wheat earlier but only little methods got success in that. Therefore, hybrid wheat is having a scoring relative importance globally. For hybrid seed production, the cleistogamous floral nature of wheat is main bottleneck that leads anthers inside the flower, enable it strictly self-fertilizer. Hence, high anther extrusion is required to promote allogamy and to satisfy with high level of pollen presence for the female plant for hybrid seed production. Male sterility also provides the best opportunity to adhere self-fertilization and promotes pollen access for hybrid seed production. Recently, new technologies at genomic level are providing new opportunities for hybrid seed production. The idea is to brief the problems existing in wheat breeding and explore the recent activities based on molecular technologies so that one could utilize the recent methods to improve the system of wheat breeding, its cost and prerequisite the system of hybrid development in wheat.

Keywords: Wheat, Anther Extrusion, Male sterility, Genome, Hybrid

Selection of phenotypically superior trees of Jujube (*Ziziphus jujuba* Mill.) as an agroforestry tree species under stress conditions

M. Maqbool Rather, Firdous A. sheikh, P. A. Khan and Manzoor A. Dar

ABSTRACT

Jujube (*Ziziphus jujuba* Mill.) is one of the most important genera of Rhamnaceae or bulk thorn family. It comprises about 170 species, distributed mostly in the tropical and sub-tropical regions of the Old and New World, with a few species occurring in the temperate regions (Liu and Cheng, 1995) but only 40 species of this genus have been reported throughout the world (Soliman and Hegazi, 2013; Li *et al.*, 2007). Its common name is Chinese date or Chinese jujube. It is native to China and distributed in over 47 countries around the world (Li *et al.*, 2005; Liu *et al.*, 2014). The taxon has been found commonly growing on the terraced tablelands, locally called as ‘Karewas’, and along the foot hills in the Kashmir Valley (Akhter *et al.*, 2013). The tree is very graceful and ornamental in appearance. The fruit is rich in nutrients, and famous for the sweet, apple-like taste with potassium, phosphorus, calcium and manganese being the major mineral components, as well as iron, sodium, zinc and copper (Li *et al.*, 2005). The jujube is a rich source of vitamin C and vitamin B-complex. Jujube is highly tolerant to drought and well adapted to diverse climatic conditions and not only survives but produces reasonable yield and growth under severe drought helped by its deep and substantial taproot. The study has been undertaken to select tree species from different sources as an agroforestry tree component under stress conditions. Tree characters viz. tree height, DBH, clear bole, crown spread and fruit bearing have been utilised as a base for selection of phenotypically superior trees. Initial study suggests that the seeds from different sources differentiated in producing seedlings with varied growth characteristics.

3rd International Conference on “Global Initiative in Agricultural, Forestry and Applied Sciences for Food Security, Environmental Safety and Sustainable Development (GIAFAS-2021)”

Effect of neem coated urea through different nitrogen application schedule on nutrient status of soil in rice (*Oryza sativa* L.)

Shriman Kumar Patel¹, Yogesh Kumar², and Atul Kumar³

^{1,3}Department of Soil Science and Agricultural Chemistry, Bihar Agricultural University, Sabour Bhagalpur-813210

²Department of Soil Science and Agricultural Chemistry, Sardar Vallabhbhai Patel University of Agriculture and Technology, Meerut (U.P.)

ABSTRACT

A field experiment was conducted during *kharif* season of 2016 at Crop Research Centre of Sardar Vallabhbhai Patel University of Agriculture and Technology, Meerut (U.P.) to evaluate the nitrogen release pattern and use efficiency of neem coated urea under different application schedule in rice (*oryza sativa* L). The soil of the experimental field was well drained, sandy loam in texture, alkaline in reaction (pH 8.03), low in available nitrogen, medium in available phosphorus and available potassium with an electrical conductivity of 0.21 dS m⁻¹. Eleven treatments comprising: T₁- control (No N), T₂- 50:25:25 N, T₃-33:33:33 N, T₄-25:25:50 N, T₅-25:50:25 N, T₆-00:50:50 N, T₇-00:75:25 N, T₈-00:25:75 N, T₉-50:50:00 N, T₁₀-50:00:50 N through neem coated urea as basal, at maximum tillering and panicle initiation stage and T₁₁-50 (basal) + LCC based (≤ 4 critical value) replicated thrice estimated in a randomized block design. The data on content and uptake of nutrients at various stages along with available N, P and K as well as availability at surface and sub surface layer was recorded as per the standard procedure. The experimental results revealed that uptake of nitrogen, phosphorus and potassium in rice differ significantly among different treatments and were maximum with the application of 25% N as basal, 50% at maximum tillering and 25% at panicle initiation stage. Application of 50% N as basal and rest through LCC (≤ 4) critical value improved the organic carbon of soil. Therefore, application of 25% N as basal, 50% at maximum tillering and 25% panicle initiation stage, proved to be better for maintaining the nutrient status of soil. The rice also accumulated significantly higher nitrogen in grains, straw as well as total (69.65, 59.04 kg ha⁻¹ and 128.69 kg ha⁻¹, respectively) in this treatment.

Keywords: Neem coated urea, LCC, Nutrient content and uptake.

Role of Nanotechnology in Agriculture

Abhishek kumar¹, Vibha kumari² and Manish Kumar³

^{1, 2, 3} Department of Agronomy, Bihar Agricultural University, Sabour Bhagalpur-813210

ABSTRACT

Nanotechnology has gained intense attention in the recent years due to its wide application in several areas like medicine, catalysis, energy and material. The excess use of chemical fertilizers and pesticides has shown negative impacts on soil health and environment. Chemical residues destroy the soil ecosystem by affecting the non-targeted organisms and decrease soil fertility simultaneously. To prevent such adversity in soil and environment, researchers have applied nanotechnology in agriculture. In recent years the use of nonmaterials has been considered as an alternative solution to control plant pests including insects, fungi and weeds. Nanotechnology is the rising technology of the current decade, which has shown promising results in controlling excess agri-inputs and maintaining environmental balance. The characteristics of controlled release capacity and targeted delivery of nano fertilizer and nano pesticide showed high activity in comparison to conventional fertilizers and pesticides. Different nano fertilizers and nano pesticides such as silver, zinc, iron, titanium, phosphorus, molybdenum and polymer nano particles have shown great potential as plant growth and pest control agents. Nano herbicides eradicate weeds in an eco-friendly way, without any toxic residues in soil and environment (Pérez-de-Luque and Rubiales. 2009). Properly well-designed nano capsules provide enhanced penetration through cuticle and allow slow and controlled release of active ingredients on reaching the target weed. 100% growth inhibition was seen in the *Pythium ultimum*, *Magnaporthe grisea*, *Colletotrichum gloeosporioides* and *Rhizoctonia solani*, showed at 10 ppm of the nano sized silica-silver (Park et al. 2006). A higher amount of Zn was present in the seed when treated with nano scale ZnO, improves the germination, root growth, shoot growth dry weight and pod yield of the treated seeds (Prasad et al. 2012). It is found that the combined application of Zinc oxide and Iron oxide nano particles @ 150 ppm each resulted in better growth and higher yield in strawberry (Kumar et al. 2017). Nano sensors also showed proficient applications in smart agriculture systems and food security. Those nano particles with small size to large surface area (1-100 nm) have several potential functions. Therefore, the development of nano chemicals has appeared as promising agent for the plant growth, fertilizer, herbicide and pesticides.

Keyword: Nanotechnology, Nano particle, Nano sensor, Nano herbicide, Nano capsule

3rd International Conference on “Global Initiative in Agricultural, Forestry and Applied Sciences for Food Security, Environmental Safety and Sustainable Development (GIAFAS-2021)”

Bio-herbicides for weed control

Manish Kumar¹, Abhishek Kumar² and Gautam Pratap Singh³

^{1,2} Department of Agronomy, Bihar Agricultural College, Sabour Bhagalpur-813210 (Bihar)

³ Department of Horticulture (Vegetable & Floriculture), Bihar Agricultural College, Sabour Bhagalpur-813210 (Bihar)

ABSTRACT

Weeds are the major cause of crop yield reduction. Yield losses caused by weeds are estimated 35% in a dozen crops based on NRCWS (2005). Since the implementation of synthetic herbicides in crop protection system, weeds have continuously developed resistance. Due to the development of herbicide resistance and a trend towards a chemically free environment, biological control using plant pathogens (bioherbicides) has been best option (Hoagland, 2007). There is a need for suitable alternative of chemical herbicides. Bio-herbicides include microbes-fungal, bacterial and viral pathogens and plant-based products include plant extract and essential oils. The bio-herbicide inhibits of physiological activities in weeds like nutrient uptake, photosynthesis etc. and disrupt cellular functions like cell wall and cell membrane, hormone and toxic production etc. Different types of formulation have been developed to enhance the shelf life of different bioherbicides for successful commercialization. The use of phytopathogenic fungi in biological control of weeds may represent a promising alternative to the use of chemicals and may lead to sustainable of agro-ecosystem (Adetunji et al., 2017). The use of bioherbicides containing fungal active ingredients or natural fungal molecules is one of the possible solutions to reduce the use of chemical products. The allelopathy plants have been recommended as a suitable alternative for weed control under sustainable agriculture. Partheniumleaf extracts inhibited the germination and growth of *Lapidiumsp* and *Avanafatua* and pre-emergence application of parthenium extract was more effective compared to post emergence application (Marwat et al., 2008) The application of different botanical herbicides had a significant influence on weed population, weed dry matter, weed control efficiency, weed control index and growth and yield of rice (Deb et al., 2019). The bioherbicide market will continue to grow in future due to increase herbicide resistance problem in weed and high demand of safe and quality food product.

Key Word: Weed, Bioherbicide, Herbicide, Crop and Allelopathy and fungus.

Foliar nutrition of crops for better production and productivity

Vibha Kumari¹ and Abhishek Kumar²

^{1,2} Department of Agronomy, Bihar Agricultural University, Sabour, Bhagalpur-813210

ABSTRACT

Plant nutrition is the study of the chemical elements and which are necessary for plant growth, development and its metabolism. Foliar nutrition is recognized as an important method of fertilization. Foliar fertilization of nutrients direct applied to plant surface via leaves and stems and ultimately improve their absorption efficiency (Basavaraja et al., 2018). Foliar nutrients usually penetrate the leaf cuticle or stomata and enter the cells facilitating easy and rapid utilization of nutrients (Latha and Nadanassababady, 2003). The advantages of foliar fertilizers were more noticeable to growing conditions restricting the incorporation of nutrients from the soil (Verma et al., 2000). Foliar application of macro and micronutrients like N, P, K, S and B was found to be more advantageous than soil application and also avoiding the depletion of these nutrients in leaves, thereby resulting in an increased photosynthetic rate, better nutrient translocation of these nutrients from leaves to the developing seeds (Manonmani and Srimathi, 2009). Foliar application of nutrients increased nutrient uptake and better translocation of nutrients and adequate availability of nutrients resulted in enhanced growth attributes and yield attributes (Kaur et al., 2019, Hamouda et al., 2015). Foliar feeding is often the most effective and economical way to meet the nutrient demand of the crop at critical stage (Shwetha et al., 2018). Foliar application of nutrients enhances the plant's vegetative growth and improved the ability of plant for the synthesis and storage of metabolites and yield and seed quality of bean (Tahir et al., 2014). Since, foliar fertilization is gaining more importance in recent years due to availability of soluble fertilizers and is of great significance in rainfed areas and under changing climatic conditions. Foliar nutrition is resorted, increasing yield, enhancing crop quality and also economizing crop production.

Keyword: Plant Nutrition, Foliar Nutrition, Water soluble fertilizers

3rd International Conference on “Global Initiative in Agricultural, Forestry and Applied Sciences for Food Security, Environmental Safety and Sustainable Development (GIAFAS-2021)”

Biofortification of Micronutrients in Pulses

Abhinav Kumar¹

¹Department of Plant Genetics and Breeding, BAU, Sabour

ABSTRACT

Malnutrition is a serious problem in India and other developing countries around the world. It mostly affects the children and women in the country. Under this, micronutrient malnutrition is highly prevalent in all age groups of people. Micronutrients are important for proper growth and development. The major food crops which are part of our diet are deficient in one or more micronutrients. It seriously affects people with low incomes and people from rural backgrounds. The major focus of the Indian agricultural system is on increasing grain production and productivity. It has led to an increase in micronutrient deficiency in food crops, thereby increasing micronutrient malnutrition in the population. Now, there is a shift in research and trend and more focus is on producing nutrient-rich food crops in sufficient quantities to improve the nutritional quality of various foods. Biofortification is one of the sustainable and cost-effective methods of delivering micronutrients to the population. Biofortification is the process of increasing the concentration of minerals or micronutrients (mainly zinc and iron) in important staple crops. Pulses are one of the cheapest sources of proteins, vitamins, and micronutrients, and can be supplied to people through their daily diet. Pulses are rich in protein (20–30%) and an excellent source of dietary fibre, low molecular weight carbohydrates, essential amino acids, minerals, and vitamins which may play a role in the functioning of the immune and digestive system. Pulses have several health benefits. The biofortification of pulses has a huge potential to eliminate the problem of micronutrient deficiency and malnutrition. There are various ways of biofortification of pulse crops with nutrients such as agronomic interventions, breeding, genetic modification, and microbiological interventions. Therefore, the aim of biofortification is to increase nutrient accumulation and related plant attributes in those commercially accepted and superior cultivars that are already in the food chain due to their good agronomic performance, primarily the seed yield.

HAPLOTYPE BASED BREEDING – NOVEL METHOD TO DEVELOP TAILOR MADE RICE.

Nitesh kushwaha

Division of genetics, Indian agricultural research institute, Pusa, New Delhi.

ABSTRACT

Rice (*Oryza sativa* L.) is the one of the major food crops of the world. In Asian countries it serves as staple food crops, in India it is primary source of nutrition in most of the states so it is main food crop in Indian prospective. But due to ever increasing population, and accelerated rate of climate change and new evolving pathogens and their variants, agricultural fraternity is facing major challenge to stabilise the yield of the crops including rice. Continuous research is being carried out in the wake of these problems, to develop rapid, efficient breeding approaches to mitigate these bottlenecks restricting the yield performances. In recent times one such approach known as haplotype-based breeding has attracted breeders globally, which is showing immense promise in achieving these objectives for crop improvement. A haplotype can refer to a combination of alleles or to a set of single nucleotide polymorphisms (SNPs) found on the same chromosome. They tend to be inherited together because they're very close together. Identification of these haplotypes which leads to superiority of genotypes in different conditions and combining these haplotypes in different combinations to develop environment smart crops with desired characteristics. Many studies in various crops have led to development of hypothesized or tailored varieties via haplotype-based breeding approaches. Haplotype based approach using modern breeding tools like genomics, GWAS, transcriptomics, etc., opens the way to design crops suitable to our requirement with more precision. As we known rice is the one most diverse crop globally, having its occurrence all across the latitude, it is storehouse of genes and their different haplotype combinations leading to superiority in different ecosystems. Here we will deal with case study of experiment related to rice grain yield and quality which was carried out in collaboration of three world class institute, viz IRRI, Philippines, IRRI, India centre and ICRISAT, Hyderabad. They used 3KRG panel to carryout this experiment. Haplotype analysis of 120 previously functionally characterized genes, influencing grain yield (87 genes) and grain quality (33 genes) revealed significant variations in the 3K rice genome (RG) panel. For selected genes, meta-expression analysis using already available datasets along with co-expression network provided insights at systems level. Also, candidate gene-based association study for the 120 genes was conducted and 21

3rd International Conference on “Global Initiative in Agricultural, Forestry and Applied Sciences for Food Security, Environmental Safety and Sustainable Development (GIAFAS-2021)”

strongly associated genes 10-grain yield and quality traits were identified. They reported superior haplotypes upon phenotyping the subset of 3K RG panel, SD1-H8 with haplotype frequency (HF) of 30.13% in 3K RG panel, MOC1-H9 (HF: 23.08%), IPA1-H14 (HF: 6.64%), DEP3-H2 (HF: 5.59%), DEP1-H2 (HF:37.53%), SP1-H3 (HF: 5.05%), LAX1H5 (HF: 1.56%), LP-H13 (3.64%), OSH1-H4 (5.52%),PHD1-H14 (HF: 15.21%), AGO7-H15 (HF: 3.33%), ROC5-H2 (31.42%), RSR1-H8 (HF: 4.20%) and OsNAS3-H2 (HF:1.00%). Furthermore, haplotype analysis explained possible genetic basis for superiority of selected mega-varieties. Overall, this study suggests the possibility for developing next-generation tailor-made rice with superior haplotype combinations of target genes suiting future food and nutritional demands via haplotype-based breeding.

Process Optimization for Manufacturing of ‘Banana Enriched Ice Cream

Saloni¹, Dinesh Chandra Rai¹

Department of Dairy Science and Food Technology, Institute of Agricultural Sciences, Banaras Hindu University

ABSTRACT

Ice cream is one of the most popular sweetened frozen products, and its popularity can be due to its refreshingly cool and deliciously sweet quality. The purpose of this study was to optimise the ingredients used in the preparation of ice cream and to study the effect of storage periods on different physico-chemical properties of optimised (banana enriched ice cream) and control ice cream at 15 days interval up to 60 days. Based on the findings, it was observed that the best formulation, which included 10% banana pulp and 13.5 percent sugar, resulted in an overrun of 48.5 percent of the product. In terms of body & texture, flavour, colour and appearance, overall acceptability, sweetness and overrun, this formulation was judged to be the best suitable for manufacturing banana-enriched ice cream with projected scores of 8.4, 8.2, 8.5, 8.2, 7.8, 48.5 percent. Storage study explained that the overrun, hardness, melting rate, first dripping time, complete melting time and fat were significantly changed over the storage period but total solids, protein and titrable acidity content of optimized and control ice creams did not differ significantly throughout the storage period. On the basis of above findings, manufacturing of Banana enriched ice cream is being recommended for commercial production purpose to obtain value added ice cream.

Keywords: Formulation, Manufacturing, Optimise, Sweetened Frozen Products

Correlation and path analysis of yield and its attributing traits in sugarcane

Rajvinder Singh¹, D. N. Kamat¹, R. G. Zala¹, Pooja Kumari¹ and Saipayan Ghosh¹

Dr. Rajendra Prasad Central Agricultural University, Pusa, Samastipur (Bihar), India

ABSTRACT

An investigation was undertaken to identify sugarcane varieties suitable for identification of early maturing genotypes for higher sugar yield at Research Farm of Dr. R.P.C.A.U, Pusa. The experiment was conducted in Randomized Block Design with three replications during spring season 2018. Correlation and path analysis in twelve varieties of sugarcane for twenty-one different morphological and juice quality characters were studied in relation with the checks viz. CoLk94184 and CoSe95422. Analysis of correlation revealed that the character sugar yield was observed to have highest and positive genotypic correlation with character number of millable canes at harvest (0.977) followed by cane yield at harvest (0.963). However, it was negatively correlated with purity percentage at 8 months stage (-0.491), cane diameter at harvest (-0.363), number of internodes at harvest (-0.263), length of internodes at harvest (-0.081) and fibre percentage at harvest (-0.039) at genotypic level. The character sugar yield was observed to have high significant and positive phenotypic association for the trait germination percentage at 45 DAP (0.510**) while non-significant and positive association was observed for the traits cane yield at harvest (0.955) followed by single cane weight at harvest (0.820). On the other hand, it was found that the traits cane diameter at harvest (-0.236), number of internodes at harvest (-0.151) and length of internodes at harvest (-0.099) had non-significant negative phenotypic association with sugar yield. Positive direct effect on sugar yield at phenotypic level was exerted maximally by cane yield at harvest (t/ha) followed by CCS percentage at 10 month stage and pol in juice at 10 month stage whereas at genotypic level maximum positive direct effect was observed in case of pol percentage in cane at harvest followed by single cane weight (kg) and brix percentage at 10 months.

3rd International Conference on “Global Initiative in Agricultural, Forestry and Applied Sciences for Food Security, Environmental Safety and Sustainable Development (GIAFAS-2021)”

Impact of Combined Abiotic and Biotic Stresses on Plant Growth and Avenues for Crop Improvement

Tushar Arun Mohanty¹, Poojashree Mahapatra², Digvijay Singh³ & Nitesh Kushwaha⁴

¹Department of Plant Breeding and Genetics, Dr. Rajendra Prasad Central Agricultural University, Pusa, Samastipur, Bihar-848125, India.

²Department of Plant Pathology, College of Agriculture, Odisha University of Agriculture & Technology, Bhubaneswar, Odisha-751003, India

³Department of Plant Breeding & Genetics, Bihar Agricultural College, Bihar Agricultural University, Sabour, Bihar

⁴Division of Genetics, ICAR-Indian Agricultural Research Institute, New Delhi

ABSTRACT

Global warming results in the concurrence of a sort of abiotic and biotic stresses, thus affecting agricultural productivity. Plants growing in their natural habitats are often challenged simultaneously by multiple stress factors, both abiotic and biotic. Plants are subjected to a wide range of environmental stresses which reduces and limits the productivity of agricultural crops. The abiotic stress causes the loss of major crop plants worldwide and includes radiation, salinity, floods, drought, extremes in temperature, heavy metals, etc. On the other hand, attacks by various pathogens like fungi, bacteria, oomy-cetes, nematodes and herbivores are included in biotic stresses. As plants are sessile in nature, they have no choice to escape from the seen environmental cues. Occurrence of abiotic stresses can alter plant– pest interactions by enhancing host plant susceptibility to pathogenic organisms, insects, and by reducing competitive ability with weeds. On the contrary, some pests may alter plant response to abiotic stress factors. Therefore, systematic studies are pivotal to know the effect of concurrent abiotic and biotic stress conditions on crop productivity. However, to date, a collective database on the occurrence of varied stress combinations in agriculturally prominent areas is not available. The effect of combined stress factors on crops is not always additive, because the outcome is usually dictated by the nature of interactions between the stress factors. Plants tailor their responses to combined stress factors and exhibit several unique responses, along with other common responses. Therefore, to completely recognize the impact of combined abiotic and biotic stresses on plants, it is important to know the nature of such interactions. Development of plants with enhanced tolerance to combined abiotic and biotic stresses involves identification of physio-morphological traits that are affected by combined stresses. Research has thus far been limited to responses to individual stresses, and understanding of adaptation to combinatorial stress is restricted, but indicative of non-additive interactions. Omics data analysis and functional characterization of individual genes has revealed a convergence of signaling pathways for abiotic and biotic stress adaptation.

Keywords: stress interaction, stress combinations, Abiotic and Biotic Stresses, drought and pathogen infection, crop production, crop improvement.

Impact of Conservation Agriculture on soil Potassium dynamics under Maize based cropping system

Gopal Kumar*, PriyankaKumari, ShailjaKumari, RaginiKumari, Amitpradhan, Rajiv Padbhushan

ABSTRACT

United Nations Environment Programme (UNEP, 2013) in emission gap report identified that the agriculture can be the 1st priority among the four sectors that will contribute in national goals of reducing greenhouse gas emissions. Maize one of the most important cereals crops after rice and wheat having wider adoptability in no-till system. Seasonal dryness in maize appeared which is a limiting factor in corn cultivation and result in annual loss of corn yield approx 17%. Potassium enhanced resistance ability against drought that augmented growth of corn plants. Conservation agriculture had drawn an attention of scientist for maintaining sustainability with productivity enhance and by principal of minimum tillage reduces the green house emission. It was observed that the release pattern of different form of potassium is regulated by different tillage practices and cropping system. Observance of these view, the current studies was started in the soil of before sowing and after harvesting (2018) of the continuing Conservation Agriculture experiment on “Resource conservation technologies for stabilizing yield under different cropping system” which was started in *Kharif*- 2011 at BAC research Farm, Sabour. The research has been carried out in a split plot design, which contains three main plots of various tillage practices *viz.* Zero tillage (ZT), Permanent raised bed (PRB) and Conventional tillage (CT) and in sub-plot with three different cropping sequences

3rd International Conference on “Global Initiative in Agricultural, Forestry and Applied Sciences for Food Security, Environmental Safety and Sustainable Development (GIAFAS-2021)”

viz. maize-maize (M-M), maize-wheat (M-W) and maize-chickpea (M-C). The result from the study recorded that there is significantly increased of OC content in ZT system with M-C cropping sequences. OC shows 5.47 % increase from the initial soil at the time of start of experiment and 5.72 to 5.59 g kg⁻¹, CEC varies from 13.11 to 15.95 and 14.9 to 18.62 cmol (p+) kg⁻¹ in soil of after harvesting and before sowing respectively. Av. Nitrogen, Av. Phosphorus and Av. Potassium show the significant relationship with cropping sequences and tillage system. Higher nutrient availability recorded in ZT system followed by PRB system, lower values observed in case of CT with maize-maize and maize-wheat system. Dynamics of potassium shows by depletion of available potassium content while build up was observed in Exchangeable K (EXK) potassium means one form to other form transfer of potassium. WSK form shown depletion of potassium 11.07% while build up of 2.72% EXK was recorded. In case of NEK, depletion of 4% potassium content was observed after harvesting There was slightly no change were observed in case of TK and MK. Highest yield was observed in case of ZT system and PRB is at par with ZT system in case of yield characteristics of maize. Higher nutrient uptake was recorded in ZT system followed by PRB system. The potential buffering capacity varies from 3.31 to 18.25 cmol (p+) kg⁻¹/(molL⁻¹)^{0.5}. The soil recorded different PBC^K values but may be same activity ratio. Maximum soil have higher amount of non-specifically held potassium it means greater release of K at time of stress. Result shows at time of stress of potassium the ZT with maize-chickpea crop rotation shows positive response for uptake of potassium. The higher values of AR^K shows in case PRB with maize-maize the intensity.

Keywords: Conservation agriculture, Maize, Forms of potassium, Buffering capacity, Activity ratio, Quantity intensity

Embryo rescue in wide hybridization

Awnish Kumar¹, *Digvijay Singh¹, Jyoti Kumari¹, Chandan Kishore¹, Ravi Shankar Singh¹

¹Department of Plant Breeding and Genetics, Bihar Agricultural University, Sabour, Bhagalpur, Bihar-813210

ABSTRACT

Embryo rescue procedures have been successfully used to prevent the embryo abortion for producing interspecific and intergeneric hybrids and progeny of other incompatible crosses. There are large number of techniques for embryo rescue namely embryo culture, ovule culture, ovary culture, ovary slice culture, ovule perforation technique, embryo-endosperm transplant technique. While embryo culture is the most widely used embryo rescue procedure, ovule and ovary culture are more suitable for small seeded species or very young embryos. For all the techniques, the probability of success increases with maturity of the embryos; however, cultures must be initiated before embryos abort. The type of medium needed for rescuing embryos is strongly dependent on the stage of embryo development. Young embryos require a complex medium with high sucrose concentrations, while more mature embryos can usually develop on a simple medium with low levels of sucrose. Continued investigations into nutritional requirements of young embryos, along with modifications of existing embryo rescue techniques, should lead to successful application of this highly valuable *in vitro* procedure to additional crop species. Along with rescuing embryo of wide crosses, this technique is also used to overcome or solve other problems related to crop plants like overcoming seed dormancy, production of haploids, shortening of breeding cycle, germplasm exchange, germination of seeds of obligatory parasitic plant etc. This technique could be a boon for plant breeding by assisting the breeders in broadening the genetic bases of cultivars but it demands attention of the researcher for its standardization. The main limiting factor of this technique is its low success rate which can be increased by following the already published standard protocols or review of literature or by plotting the experiments in treatments and replications.

Keywords: Embryo, Embryo rescue, Wide hybridization, Culture media, Embryo abortion.

3rd International Conference on “Global Initiative in Agricultural, Forestry and Applied Sciences for Food Security, Environmental Safety and Sustainable Development (GIAFAS-2021)”

Plant breeding and climate change

Ruchika Chhaya, Sorabh Sethi, Pooja Kumari

Dr. Rajendra Prasad Central Agricultural University, Pusa, Samastipur (Bihar)

ABSTRACT

Nowadays, several global major production constraints of crop plants are identified: climate change, rapid population growth, increasing demand for food, reduction biodiversity, increasing demand for agricultural inputs and other multiple factors simultaneously affect crop plant production and productivity. These all production impediments are resulted substantial yield reduction across the world. Currently, climate change is becoming a serious challenge across the world with significant threats of food security, ecosystems, economic stability, and water resources. Climate change is caused by different agents, mainly greenhouse gas emissions from natural systems and human activities and shift in climate patterns and composition. Climate change has a potential to adversely affect agricultural productivity to the irreversible level and drives to hunger of millions of the global community. Plant breeding is the science improvement of crop plants for quantitative and qualitative traits and developing improved resistance crop technologies against biotic and abiotic stresses. Climate adaptation and mitigation are the most important and an interdependent strategy that uses for complement one another in tackling the impact of climate change and pave the way for sustainable survival of earth's inhabitants. Climate change affects food security in various ways, especially through impacting on all four components of food security (availability, accessibility, affordability, utilization and nutritional value and food system stability), through impacting on crop production and yield, through impacting on water availability, through impacting on fisheries production, through impacting on agricultural pests and through impacting on livestock production. Generally, plant breeding has profound impact on food production and will continue to play a vital role in the food security. Hence, the development of superior varieties with climate change resilient crops is necessarily important for increasing productivity with parallel to increasing human population. Therefore, conventional crop plant improvement should be integrated with marker assisted breeding procedures to address the serious challenges of the world through enhancing crop genetic improvements. To achieve fast and agricultural advancement in terms of production and productivity in the short period of time, the integration of marker assisted plant breeding is very crucial in the future world. It is difficult to overcome the global challenges of climate change in the absence of integration of biotechnology into plant improvement to enhance crop yields through addressing yield reduction and associated problems. Currently, the development of genome editing technologies, especially CRISPR/Cas9, opened new routes of fast and precise genome modification for the betterment advancing the knowledge of improvement. Genome editing is playing significant role in transmitting, insertion and deletion of new sequence at desired location in the target genome. It is possible to modify the known genes that control important traits selectively through genome editing to manipulate the phenotypes. This day, several genomic edited crops are entered into commercial markets in many developed countries like USA in addition to drought and salt tolerant varieties. Urgently, crop plant improvement with the help of potential genomic approaches is very decisive for the development of climate change resilient crops.

Bio fortification of zinc in fodder oat through foliar application

Manish Kumar*

**Department of Agronomy, Bihar Agricultural College, Sabour Bhagalpur-813210 (Bihar)*

ABSTRACT

The success of dairy production is highly dependent on high-nutritional-value feed and fodder, which accounts for 65-70 percent of animal feed costs. Intensification of production and increase of the milk yield of cows requires not only full coverage of the requirements for proteins and energy, but also an appropriate balancing of the mineral elements and vitamins with regard to physical form and interaction between the components of the feed provided (Strusińska et al., 2003). Zinc is one of the essential trace elements required by the living body as it is present in more than a hundred specific enzymes and serves as an important structural ion in transcription factors. In India, about 49% of the soils area deficit in zinc, coarse textured calcareous, alkaline soils with a sandy texture, high pH, and low soil organic matter are generally deficient in zinc availability. Available Zn in Indian grounds ranges from 0.1-24.6mg/kg soil. Zinc deficiency causes various disease or disorder in plant, animal and also in human like zinc deficiency affected the secretion of follicle-stimulating hormone, luteinizing hormone, and in males, it reduces

3rd International Conference on “Global Initiative in Agricultural, Forestry and Applied Sciences for Food Security, Environmental Safety and Sustainable Development (GIAFAS-2021)”

spermatogenesis (Hosnedlova et al. 2007). Application of zinc through foliar spray more precise work than soil application because in the regard like bio fortification we have adopt good agronomical practices which can magnified maximum part of zinc in fodder oats. Many prominent and micronutrients play an essential role in producing nutritious and good-quality fodder but zinc have different and more valuable properties than other micro nutrient. Along with essential nutrients for crop biofortification, zinc plays a crucial role in fodder oats production (Dhaliwal et al., 2020). Fortification is becoming more widely accepted as a viable method of improving a population's micronutrient status. Zinc fortification has been shown in trials to increase dietary zinc intake and total daily zinc absorption. The majority of absorption tests also show that adding zinc to food has no negative impact on the absorption of other minerals like iron. Despite the fact that zinc fortification improves total zinc absorption, only a few studies have indicated that it improves serum zinc concentrations or functional indicators of zinc status. Zinc participates in the synthesis of tryptophan, a precursor of indole acetic acid (IAA). It is required for plant growth, nitrogen metabolism, starch and chlorophyll synthesis, ATPase activity, and the transport of assimilates. It is reported that zinc facilitates significant improvement in fodder quality with maximum crude protein (CP) and crude protein yield (CPY) (Dhaliwal et al., 2020). Zinc plays an important role in enzymes activation as well as the efficiency of zinc is improved when it is used in combination with other elements like N and K (Rajput *et al.*, 1995 and Fathi *et al.*, 1990).

Key point: Biofortification, Fodder oats, Zinc, Crude Protein, Deficiency

Recent advances in Climate Smart Plant Breeding

Surabhi Sinha^{1*}, Zafar Imam², Digvijay Singh², Satyendra²

¹*Department of Genetics and Plant Breeding, BAU, Kanke, Ranchi- 834006*

²*Department of Plant Breeding and Genetics, BAU, Sabour-813210 (Bhagalpur), Bihar*

ABSTRACT

In the present scenario, climate change has become one of the most important factor limiting the agricultural crop production. This change has escalated the global warming with extreme weather events and thus, increasing the incidence of weeds, pests and pathogens. Extreme weather events has resulted into increased mean temperatures, water deficit; deeply influencing flowering, pollination, and grain-filling of most grain crops, increased atmospheric CO₂, drought etc. These factors affect the crop either singly or in combination with one or many. It therefore, calls for development of strategies to mitigate the effect of climate change on crop production. These strategies introduces us to a new era of next generation breeding. Next generation breeding relies on the availability of large plant breeding populations and germplasm collections, efficient high-throughput technologies, big data management tools, and downstream biotechnology and molecular breeding activities. Also, recent advances in the genes and genomic knowledge is introducing us to a most recent technology: Second generation biotechnologies based on cis-genics and genome editing. Most of the genes and genomic knowledge relies on the QTL (Quantitative Trait Loci), association mapping and GWAS (Genome Wide Association Studies), genomic selection (GS), genome editing and mutagenesis. Hence, these technologies are the pillars of climate smart agriculture.

Keywords: next generation breeding, climate smart agriculture, second generation biotechnologies, cis-genics.

Effect of Different Poplar (*Populus deltoides* Bartr.) Clones after eleven years of Plantation in Calciorthents of Bihar.

¹Atul Kumar , ¹Shriman Kumar Patel , ²Vijay Kumar, ³Jeetendra Kumar, ³Ajit Kumar and ³Wajid Hasan

¹*Department of Soil Science and Agricultural Chemistry, Bihar Agricultural University, Sabour Bhagalpur-813210*

²*Krishi Vigyan Kendra , Manji, Saran, Dr. Rajendra Prasad Central Agricultural University, Pusa, Samastipur (Bihar)*

³*Krishi Vigyan Kendra, Jehanabad, Bihar Agricultural University, Sabour Bhagalpur-813210*

ABSTRACT

Poplar trees are becoming extremely important as fast growing species due to the increasing need for wood and decreasing productivity of the lands. The present investigation was conducted in eleven-year-old poplar (*Populus deltoides* Bartr.) plantations established at Krishi Vigyan Kendra, Birouli, Samastipur (Bihar) to find the effect of six

3rd International Conference on “Global Initiative in Agricultural, Forestry and Applied Sciences for Food Security, Environmental Safety and Sustainable Development (GIAFAS-2021)”

promising clones (PP-5, Udai, L-52, L-49, G-48 and L-188) as one of the most important effective factors on soil properties and also to estimate the timber volume of different poplar clones. Clones were planted with 5x4 m spacing in frame of randomized block design with four replications. The soil samples were taken from 0-15 cm and 15-30 cm depth of soils under plantations of different poplar clones and from open (without trees). The results showed that the upper 0-15 cm soil in L-52 poplar clone plot had highest value (6.30 g kg⁻¹ soil) and it was 125% more over control (open). Besides, L-49 had almost similar soil organic carbon status. Hence, the soils under these two plantations have more potentiality for sequestering organic carbon. Irrespective of the soil depths, maximum reduction in PH (0.47 unit) was noticed under the canopy of L-52 followed by L-49 (0.37 unit) and the less change was noticed under L-188 (0.16 unit). Electrical conductivities (EC) under all the poplar plantations were significantly lower as compared to open. Improvement of available macronutrients such as N, P₂O₅ and K₂O, was recorded under all the plantations. Maximum build up was under L-52 followed by L-49 clones. Significant decrease in available S was recorded under Uday, G-48 and L-188, whereas L-52, L49 and PP-5 poplar clones showed significant increase in available S at both the depths of the soil over open condition. Maximum improvement of available micronutrients Fe, Cu, Mn and B was recorded under L-52 followed by L-49 clones. However, available Zn declined under all the plantations at both the depth of the soil except under the clone L-52 in the surface soil. Thus, soil fertility as reflected by soil pH, electrical conductivity, bulk density, soil organic carbon, available macronutrients (N, P and K) and micronutrients (Fe, Cu, Mn, B and S) can be improved by integration of L-52, L-49 and PP-5 clones of poplar (*Populus deltoides*) in silvicultural systems under upland calcareous soil condition, besides meeting the demand of wood for plywood and fuel.

Key words: Agroforestry, micronutrient, Calciorthents.

Application of geo-spatial study for assessment of soil quality index for tea growing soils in Kishanganj district, Bihar

Mamta Kumari, Rajkishore Kumar, B.K. Vimal, Y. K. Singh and Atul Kumar

Department of Soil Science & Agricultural Chemistry, Bihar Agricultural University, Sabour, Bhagalpur-813210

ABSTRACT

Tea (*Camellia Sinensis*) is a major commercial crop in India, China, and Sri Lanka, having originated on the Guizhou Plateau in Southwest China (Han *et al.*, 2007). India is the world's largest producer, and consumer of tea, which accounts for roughly 28 per cent of global production, and 13 per cent of the global trade. Bihar is one of the most tea growing hidden state which have need to explore up to national level. But, because of vagarious climatic constraints like high rainfall, high temperature and severe wind speed which severely devastated the growth and productivity of tea crops. The excessive rainfall has also been brought negative impact to enhanced the excess water availability which hampered the tea plant growth, and growth of new leaves on tea bushes and ultimately leads to deteriorate the quality of tea production.

Thereby, present investigation was carried out entitled on “Application of geo-spatial study for assessment of Soil quality index for tea growing soils in Kishanganj district, Bihar” Thereby, for developed the soil quality indices, data reduction technique like PCA (Principal Component Analysis) was employed after scoring and evaluating the minimum data Set (MDS) to judge the most sensitive indicators for tea growing soils which was given in descending order like available K₂O > DTPA-Mn > specific humidity > microbial biomass carbon > pH. Meanwhile, the highest value of SQI (1.62) was observed in Thakurganj block, and minimum (1.31) was observed in Kochadhamin block. For identification, and delineation of potential tea growing areas, only 8 and 15% areas belong to very low and low potential, respectively because of the evidence of sand dune patches in studied areas after performing the overlay weighted analysis, and rest of the areas covered under medium to high potential. Overall, we can be concluded that among the various soil attributes, available K₂O, soil pH, specific humidity, microbial biomass carbon, DTPA-Mn and acid phosphatase might be act as governing attributes for tea quality for farmers, scientific community, academia and stakeholders, for establish the tea processing industry and boost up the socio-economic status of farmers.

3rd International Conference on “Global Initiative in Agricultural, Forestry and Applied Sciences for Food Security, Environmental Safety and Sustainable Development (GIAFAS-2021)”

Genomics Tools for Breeding Submergence Tolerance in Rice Digvijay Singh^{*1}, Satyendra¹, Sweta Sinha² and Mankesh Kumar¹

¹Department of Plant Breeding and Genetics, Bihar Agricultural University, Sabour, Bhagalpur-813210 (India)

²Department of Molecular Biology and Genetic Engineering, Bihar Agricultural University, Sabour, Bhagalpur-813210 (India)

ABSTRACT

Flooding stress is one of the most frequent environmental stresses constraining rice production, especially in rain-fed lowland areas affecting global food supply and financial security. The intensity of rainfall events is expected to increase under future climate change scenarios, which will greatly impact rice production. Different flooding patterns can cause damage or complete yield loss in rice plants at different stages of growth. This includes (a) complete submergence due to flash flood at vegetative or pre-flowering stages, (b) stagnant flooding of medium-deep water and deepwater or floating rice, and (c) submergence at germination or anaerobic germination. At several Institute, breeding for tolerance to submergence imposed by flash flooding during the vegetative stage has been one of the institute's priority objectives for more than three decades. Several tolerant breeding lines have been developed through conventional breeding; however none of those early varieties has been widely accepted by farmers. Remarkable progress has been achieved through identification of the major quantitative trait locus (QTL) *SUB1* in the mid-1990s, which led to the identification of three ethylene responsive factors (ERFs), of which *SUB1A* is the primary contributor for tolerance. Several major QTLs have been mapped and several key genes underlying the QTLs have been cloned. These findings and the available molecular marker technology have enabled breeders to develop submergence-tolerant varieties through a fast-track marker-assisted backcrossing (MABC) strategy to introgress *SUB1* using mega varieties as recurrent parents. Recent advances in Genetics, genomics, and other modern technologies will also be continuously explored to open new avenues for understanding how rice plants cope with different types of flooding stress to meet future challenges facing rice production, most of which have intensified with global climate changes.

Keywords: flooding, submergence, QTL, *SUB1*, varieties

Influence of abiotic factors on growth and development of vegetable crops

Rahul Kumar Gupta and Ajay Bhardwaj

Department of Horticulture (Vegetable and Floriculture), Bihar Agricultural University, Sabour, Bhagalpur, Bihar-813210

ABSTRACT

Vegetables are one of the good sources of vitamins and minerals. They play an important role in ensuring food and nutritional security (Rai and Yadav 2005). Environmental-plant interaction is fundamental to growth and development of vegetable crops. Vegetables being highly perishable are very sensitive to genetic and environmental factors. Climatic and edaphic factors influence the production and productivity of vegetable crops and have greater impact on vegetative and reproductive phase of vegetables (Kumar et al. 2012). Temperature does not supply energy but control the rate of chemical reactions. Temperature influences the physiology of crops through thermoperiodism, soil temperature, vernalization and heat stress (Onwuka 2016). Light also influences the growth and development through photosynthesis and photomorphogenesis. Light quantity, quality and duration have promotive effect on vegetative part, colour of fruit and flower of vegetable crops. Exposure of high light intensity on the vegetables (fruit and leafy vegetables), deteriorates the quality of the produce (Pandey and Sinha 2016). Water is primary component in photosynthesis and respiration responsible for turgor pressure in cells. Water stress at the critical stage of growth and development leads to low mass production leads to poor yield (Kumar et al. 2012). Rahman et al. (2007) indicated that cauliflower growth parameters increased in size and weight with increase in mean growing temperatures after curd initiation up to an optimum temperature and then declined thereafter and significantly affected the growth of cauliflower. In another study Naz et al. (2018) observed reduction in fresh and dry weights of potato plants and significant increased accumulation of proline increase in heat stress conditions. In one or another way abiotic factors influence the growth and development of vegetable crops. In order to overcome environmental stress thorough screening of more abiotic stress tolerant genotypes of vegetables is required and transfer of tolerant genes by conventional and molecular methods need to be enhanced.

Keywords: Abiotic, Development, Perishable, Edaphic factor, Photomorphogenesis, Stress

3rd International Conference on “Global Initiative in Agricultural, Forestry and Applied Sciences for Food Security, Environmental Safety and Sustainable Development (GIAFAS-2021)”

BREEDING FOR FUSARIUM WILT RESISTANCE IN BRINJAL (*Solanum melongena* L.)

Prashant Patil and Dileepkumar Masuthi

KRC College of Horticulture Arabhavi, UHS Bagalkot

ABSTRACT

Brinjal or eggplant (*Solanum melongena* L.) is an important vegetable crop grown in various tropical, subtropical and temperate parts of the world. The study on “Breeding for Fusarium wilt resistance in brinjal (*Solanum melongena* L.)” was conducted during 2019-21 at Kittur Rani Channamma College of Horticulture, Arabhavi. Fusarium wilt is a major soil borne pathogen of brinjal caused by *Fusarium oxysporum* f. sp. *melongenae*. During rabi 2019, fifty three genotypes were characterized for Fusarium wilt resistance using linked SCAR markers and also evaluated for yield and quality parameters. By looking at SCAR gel profile of all the genotypes seven were identified as resistant lines. Among 53 genotypes evaluated for yield 6 lines, viz., Bangaluru, K-12D1012-6, ACC-10, K-12D10104-1, K-12D10116-6 and M-Gulla with a yield of 82.19 t/ha, 80.54 t/ha, 73.60 t/ha, 72.57 t/ha, 70.60 t/ha and 63.90 t/ha respectively were selected as high yielding lines. Among seven resistant lines identified 3 lines, ACC-50, ACC-596 and ACC-65 were used as testers to develop F₁'s by crossing with 6 high yielding lines using Line × Tester design for heterosis and combining ability studies.

PEG induced screening of tomato parents and F₁'s for drought tolerance in early germination and seedling stage

Karthik G U, Lakshmidevamma T N* and Dileepkumar Masuthi

*KRC College of Horticulture Arabhavi, UHS Bagalkot, * College of Horticulture Bangaluru, UHS Bagalkot*

ABSTRACT

Drought is one of the major abiotic stresses in reducing crop growth and yield of tomato. Development of drought tolerant cultivars through screening and selection followed by hybridization is one of the important strategy to overcome this problem. In this study, a total of thirteen parents and thirty F₁'s of tomato including one check (Arka rakshak) were screened in an completely randomized design with two replications and three treatments viz., control, 8% and 16% PEG-6000. The genotypic differences investigated were found significant for all the seedling parameters studied except for seedling biomass. With increasing concentration of PEG (16%) growth parameters of seedlings like germination percentage, germination rate and shoot length were decreased by 21.92%, 22.14%, and 5.37% respectively, and root length was increased by 2.55% compared to control. Among the parents EC-608269, EC-608271, RFT-S-3, EC-638519 and Arka vikas were exhibited superior performance and among the crosses evaluated Arka Saurabh x EC-638519, EC-608269 x EC-638519, EC-608269 x EC-634394 and Arka vikas x EC-634394 responded superior performance compared to other crosses. These parents and crosses may used to develop drought tolerant cultivars. However, degree of drought stress tolerance at the early germination and seedling stage did not maintain in all tomato lines at later vegetative or reproductive growth stages. Hence, this needs to be further investigated.

PELLETING WITH MEDICAL PLANT EXTRACT ON INCREASE VIABILITY IN ANNUAL CHRYSANTHEMUM

Dileepkumar Masuthi, Shivayogi R, Bapuraygouda Patil, Satish D and A. M. Nadaf

KRC College of Horticulture, Arabhavi, Gokak, Karnataka, India.

ABSTRACT

The chrysanthemum is one of the most beautiful and oldest flowering plant commercially grown in different part of the world. The inflorescence is having considerable importance in manufacture of pyrethrin insecticide. The species of chrysanthemum are annual and perennial herb, sometimes partly woody. The objective of this study was to evaluate the effects of botanicals on annual chrysanthemum with different locally available botanicals on germination and seedling growth. The treatments included Alovera leaf sap extract, mint leaf extract, coleus leaf extract, sweet flag root extract, pongemia leaf extract and were compare with local control. The germination test was carried out in laboratory in petridish by using germination paper and recorded on 7th day. Seed treatments improved seed germination and early seeding growth traits included germination percentage, Shoot length, Root length, seeding dry matter and seedling vigour index compared and obtained result shows that coleus has given the maximum germination (74.67 %) and shoot growth (4.23 cm), Dry matter (0.0103 gm) and SVI-I (514) and sweet flag has given best results for the root growth (2.7 cm) compared to control and rest of the treatments. And next best treatment was treatment with mint and coleus can be a better medicinal priming treatment for commercial cultivation.

3rd International Conference on “Global Initiative in Agricultural, Forestry and Applied Sciences for Food Security, Environmental Safety and Sustainable Development (GIAFAS-2021)”

Pre-Germination Treatments on viability in ridge gourd (*Luffa acutangla* L.).

DILEEPKUMAR A M, SATISH D, A.M.NADAF AND G. S. PRAVEENAKUMAR .

KRC College of Horticulture, Arabhavi, Gokak, Karnataka, India.

ABSTRACT

Ridge gourd is a very important Indian vegetable crop and can be grown throughout the year. It belongs to the family cucurbitaceae and fruit is the economical and edible part of the crop. The present investigation was carried out at Kittur Rani Chennamma College of Horticulture , Arabhavi, to study the effect of different botanical extracts of medicinal plants on germination, shoot length and root length in ridge gourd. Seeds were treated with botanical extracts by soaking overnight in of Eucalyptus (50% concentration), coconut water (50% W/V), Pongamia leaf extract (25%), Aloe vera gel (50% W/V), compared with control. Seeds were sown in between the papers and observations were recorded as per ISTA standards at its final count *i.e.*, 14th day. Germination percentage was maximum (65 %) when treated with coconut water and Pongamia leaf extract. Even shoot length was recorded maximum (27 cm) in the treatment of coconut water followed by Aloe vera gel (26 cm). The seeds of ridge gourd may be treated with pongamia leaf extract or coconut water to get higher germination compared to untreated control.

Antioxidant content of nutri-dense composite mix

Deeksha Naik¹ and Uma Kulkarni²

1Department of food science and nutrition, College of Community Sciences, University of Agricultural Sciences, Dharwad

2Department of food science and nutrition, College of Community Sciences, University of Agricultural Sciences, Dharwad

ABSTRACT

The present research work on development and evaluation of composite flour was carried out to develop nutri-dense flour from different ingredients (wheat, green gram, horse gram, skim milk powder and drumstick leaves). The acceptable ratio wheat: green gram: horse gram ratio was 50:25:25, 20gm of skim milk powder incorporation was acceptable and 10gm of dehydrated drumstick leave powder was acceptable. Hundred gram of Poshan mix contains 4.31g moisture, 1.13g fat, 21.30g protein, 2.68g ash, 5.94g crude fiber, 69.54g carbohydrate and 373.52 kcal of energy. It is also good source of minerals such as iron (11.81 mg/100g), calcium (329.48 mg/100g) and zinc (6.29 mg/100g). The developed composite mix provides antioxidants such as total phenols (466.97 mg/100g), alpha tocopherol (1.09 mg/100g) and phytic acid (296 mg/100g). Antioxidant activity, radical scavenging activity (% inhibition) was 85.31. Improved micronutrient content and antioxidant content was due to 10% incorporation of drumstick leave powder. Developed composite mix was rich in both macro and micronutrients. Hence it can be further used in treating malnutrition and deficiency disorders.